

Fittings for commercial vehicles

Ford



PROFESSIONALITY IN MOVEMENT

TERMS OF SUPPLY

- Floorings and linings supplied in several parts.
- Floorings, linings, roof racks and ladder racks are supplied **unassembled**.
- Modules are supplied **pre-assembled** complete with fixing material to the vehicle.
- For **product installation** we suggest to contact the expert assistance of our network of **authorised installation centers** (see back cover).
- The products are supplied including **packing**.
- Our products are covered by a **3-years warranty**.
- **Load capacity** data refer to **uniformly distributed loads** (p.u.d.)

CERTIFIED PRODUCTION

Successfully certified, Quality Assurance Certification since over ten years.



CRASH TEST STORE VAN



Passed the **CRASH TEST** carried out according to the recent European regulations. **ECE-R17** with impact at **50 Km/h**.

TESTED AND CERTIFIED SAFETY



STORÉ VAN has obtained the prestigious **GS** certification for its loading ramps and interior fittings.



STORÉ VAN also boasts the rare **GS** certification for the universal ladder rack.

Store Van

A TRADEMARK OF FAMI'S GROUP

Fami's constant focus on the market trends, combined with studies for customized products, has been the winning strategy also for the last born brand name – STORE VAN - which offers fittings for commercial vehicles of all types. The accurate designed modules and the perfect adaptability for the most different personalised projects, confirmed the quality and supremacy of Store Van's components.

The achieved success allowed Store Van to become one of the most reliable and popular supplier among the international commercial vehicles producers.



PROFESSIONALITY IN MOVEMENT

Store Van first introduced an innovative installation system without drilling the van bodyworks to fix the equipments, guaranteeing functionality, quality, steadiness and aesthetic features, both for estate cars and for large vans and fleets.

LOGISTIC QUALITY SYSTEMS

Fami's strategy develops through products versatility, while each project becomes exclusive and customised. This strategy, along with advanced industrial processes, originates fitting systems suitable to meet all customers' requirements.

Fami, one of the leading Company in the field of industrial storage systems, gives priority to the technological features but also considers the design and the "soul" of the product, signing each article with a perfect balance of technology and "heart".



Fami stands out for its high technology and original solutions, like industrial storage, work stations and conductive systems for the electronic industry. All Company's advanced solutions can be employed and diversified in different applications, becoming Fami the leading Company in its field as far competence and competitiveness.



	MODEL	VEHICLE DATA	PAGE
	Transit Connect Van SWB low roof	2,8 m ³ L1 H1 wheelbase 2664 mm height 1814 mm	17-22
	Transit Connect Van LWB high roof	3,7 m ³ L2 H2 wheelbase 2912 mm height 1981 mm	23-26
	Transit Van front-wheel drive SWB low roof	5,62 m ³ L1 H1 wheelbase 2933 mm height 2067 mm	31-34
	Transit Van front-wheel drive MWB low roof	6,45 m ³ L2 H1 wheelbase 3300 mm height 2056 mm	35-38
	Transit Van front-wheel drive MWB medium roof	7,78 m ³ L2 H2 wheelbase 3300 mm height 2371 mm	39-42
	Transit Van rear-wheel drive MWB medium roof	7,34 m ³ L2 H2 wheelbase 3300 mm height 2387 mm	43-46
	Transit Van front-wheel drive MWB high roof	8,85 m ³ L2 H3 wheelbase 3300 mm height 2601 mm	47-50
	Transit Van rear-wheel drive MWB high roof	8,40 m ³ L2 H3 wheelbase 3300 mm height 2617 mm	51-54
	Transit Van front-wheel drive LWB medium roof	8,97 m ³ L3 H2 wheelbase 3750 mm height 2381 mm	55-58
	Transit Van rear-wheel drive LWB medium roof	8,45 m ³ L3 H2 wheelbase 3750 mm height 2397 mm	59-62
	Transit Van front-wheel drive LWB high roof	10,20 m ³ L3 H3 wheelbase 3750 mm height 2599 mm	63-66
	Transit Van rear-wheel drive LWB high roof	9,69 m ³ L3 H3 wheelbase 3750 mm height 2615 mm	67-70
	Transit Van Jumbo LWB EF high roof	12,28 m ³ L3L H3 wheelbase 3750 mm height 2622 mm	71-74

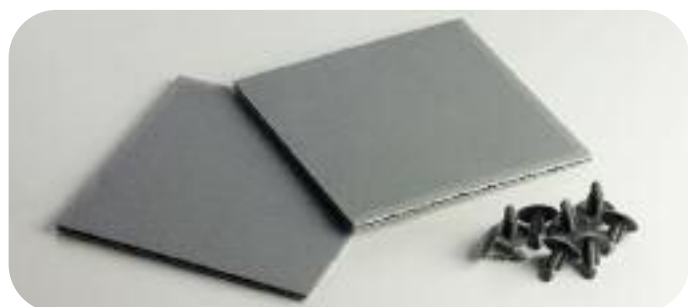

LININGS

4 mm thick polypropylene honeycomb linings with scratchproof surface. Lightweight and robust.

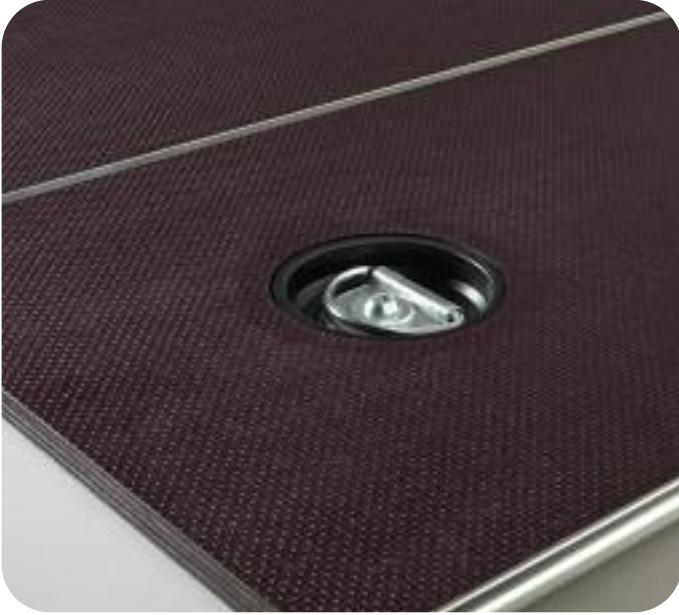

FLOORINGS

Pre-shaped loading floors in one or more jointed pieces with extruded aluminium inserts. Made of 12 mm thick birch and conifer phenolic multi-ply, resin-bonded on both faces and a wear-resistant and slip-proof surface treatment.



DRAWERS

Easy and intuitive one hand opening with handle operated opening and closing safety stop. Wide range of dividing options of the drawers by means of plastic or metal accessories.

Load capacity: 50 Kg



RETRACTABLE SHELVES

Retractable shelves for one or two tool cases with the possibility of introducing tool cases with different heights and depths.

Load capacity: 50 Kg



VICE WORKBENCH

Retractable vice workbench complete with steel vice, swivel base, jaws width 100 mm.

Technical features

TALENTO ladder rack rails
with **lowering system** with brake for
ladders weight up to 60 kg.



ALADIN ladder rack rails
with **servo-assisted lowering and lifting system** for ladders weight up to 60 kg.



LOADING RAMPS



Servo assisted loading ramps with tubular steel structure and knurled slip-proof aluminium platform. Connection to the vehicle by means of a telescopic column and self-positioning feet.

Load capacity from: 600 to 1500 Kg.

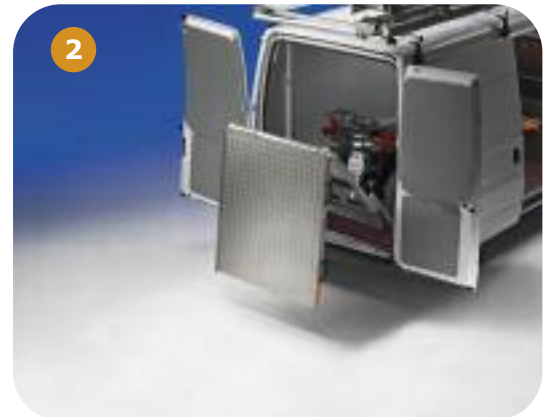

292 mm DEEP TOOL CASES

**Order no. VAL 001****Case with boxes**

Dim. 438x292x67 mm (WxDxH)
Internal solutions with:
2 green, 2 blue, 5 yellow,
10 red boxes.

**Order no. VAL 002****Case with boxes**

Dim. 438x292x67 mm (WxDxH)
Internal solutions with: 8 blue,
8 red boxes.

**Order no. VAL 003****Case with boxes**

Dim. 438x292x102 mm (WxDxH)
Internal solutions with: 2 blue, 2
green, 5 yellow, 10 red boxes.
Upper tray with 20 red and 10
yellow boxes.

**Order no. VAL 004****Case with boxes**

Dim. 438x292x102 mm (WxDxH)
Internal solutions with:
4 green, 4 blue boxes.
Upper tray with 20 red and
10 yellow boxes.

343 mm DEEP TOOL CASES

**Order no. VAL 005****Case with boxes**

Dim. 438x343x67 mm (WxDxH)
Internal solutions with:
2 green, 3 blue, 6 yellow,
12 red boxes.

**Order no. VAL 006****Case with boxes**

Dim. 438x343x67 mm (WxDxH)
Internal solutions with:
8 green boxes.

**Order no. VAL 007****Case with boxes**

Dim. 438x343x102 mm (WxDxH)
Internal solutions with:
2 green, 3 blue, 6 yellow, 12 red
boxes.
Upper tray with 24 red and 12
yellow boxes.

**Order no. VAL 008****Case with boxes**

Dim. 438x343x102 mm (WxDxH)
Internal solutions with:
12 blue boxes.
Upper tray with 24 red and 12
yellow boxes.

ACCESSORIES FOR MODULES



Order no. ACS 001
Hand washing kit



Order no. ACS 002
Can holder kit with 20
litres capacity metal can



Order no. ACS 003
Supports with belt strap for
gas cylinders and
extinguishers



Order no. ACS 004
First aid kit



Order no. ACS 005
Paper towel holder kit
with paper towel
Ø 140 mm



Order no. ACS 006
DIN A4 document
holder



Order no. ACS 007
Spray-can holder kit



Order no. ACS 008
Painted aluminium
cable saddles

LOAD RETAINING BARS AND BELTS



Load retaining bar kit available in 3 dimensions:

Order no. ACS 009

Load retaining bar length 1000 mm
Pair of polyester belts length 3260 mm

Order no. ACS 010

Load retaining bar length 1500 mm
Pair of polyester belts length 3260 mm

Order no. ACS 011

Load retaining bar length 2000 mm
Pair of polyester belts length 3260 mm

CRANES



Revolving crane with positioning brake and folding arm. Including 12 V motor and lifting hook sliding on an aluminium guide and electric limit switch, equipped with remote control with cable.

Load capacity from: 150 to 190 Kg.

OPTIONAL ACCESSORY NOT AVAILABLE FOR ALL VEHICLES MODELS

COMPRESSORS AND RETRACTABLE HORIZONTAL SYSTEMS



Retractable horizontal aluminium frames. Mechanical stop of the frame in opening and closing.

Possibility of blocking the shelf in any opening position.

Load capacity: 300 Kg.

Extraction: 60 %

Vertical compressors 220V - 380V.

Capacity: 50 - 100 LT



COLLAPSIBLE VICE WORKBENCHES



Collapsible vice workbenches with floor support.

Work bench height adjustable.

Top width: 240 / 340 mm

Depth: 1150 mm



LIFTING DOORS



Lifting doors with assisted opening.

Width: 508 / 717 / 1016 / 1225 / 1524 mm

Useful height: 350 / 400 mm



SHELVES



Shelves available for modules:

Length: 508 / 717 / 1016 / 1225 / 1524 mm

Depth: 265 / 365 mm

Front height: 35 mm

Back height: 100 mm

Available with or without polypropylene containers

Strategically strong



Connect L1 H1 - 2,8 m³

Vehicle equipped with:

1	ord. no. POS 301	ladder rack (ladder not supplied)
1	ord. no. PIL 301	wooden flooring
1	ord. no. PAN 301	polypropylene lining
1	ord. no. PAR 301	polypropylene lining
1	ord. no. MDL 010	module
1	ord. no. MDL 007	module
1	ord. no. ACS 007	spray cans holder kit
1	ord. no. ACS 004	first aid kit
1	ord. no. ACS 003	support with belt for gas cylinders and extinguishers (extinguisher not supplied)

- › **FAST ASSEMBLY**
- › **TOTAL MODULARITY**
- › **SAFETY SOUND ABSORBING ELEMENTS BETWEEN THE VARIOUS METAL COMPONENTS**
- › **ERGONOMETRIC SHAPES**
- › **HEIGHT ADJUSTMENT IN PITCH OF 25 mm OF THE VARIOUS ELEMENTS**



CONNECT







FLOORINGS AND LININGS

for CONNECT with RH side sliding door and rear leaf doors, sheet metal side walls

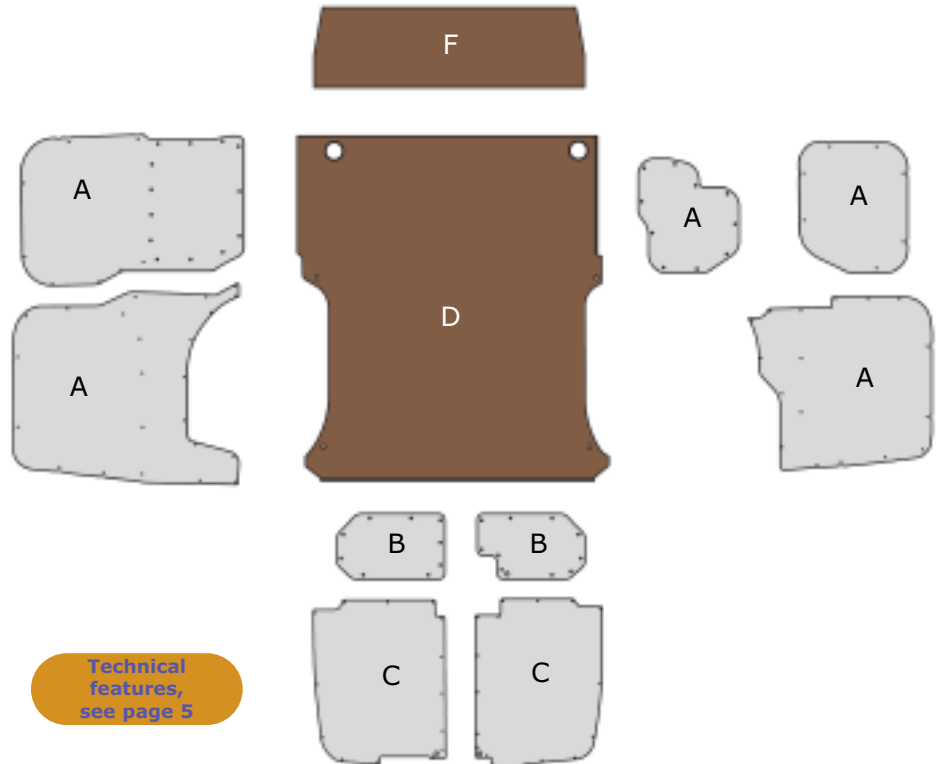
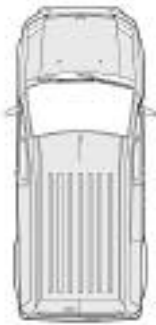

A + B Polypropylene linings Order no. PAN 301

Weight: **5,45 Kg**

Polypropylene linings for:

- LH side wall
- RH side wall and sliding door
- lower section of rear leaf doors

C Polypropylene linings Order no. PAR 301

Weight: **1,68 Kg**

Polypropylene linings for:

- upper section of rear leaf doors

D Flooring Order no. PIL 301

Weight: **18,30 Kg**

12 mm thick wooden flooring phenolic coated and predrilling for lashing hook supports.

F Bulkhead Order no. PIR 301

Weight: **3,90 Kg**

12 mm wooden phenolic coated bulkhead panel.

ROOF RACK



ROOF RACK only for Connect with rear leaf doors

Order no. POT 301

Dimensions: **2000x1400 mm** (WxD)

Weight: **19,70 Kg**

Roof rack complete with:

- 2 aluminium crossmembers with fixing connectors and rubber profile
- 1 additional crossmember with supports
- 2 2000 mm long aluminium side upstands
- 1 aluminium loading roller

Supplied with **stainless steel** screws for fixing.

Load capacity: 81 Kg (p.u.d.)

LADDER RACK

The ladder rack rail can be mounted on the right or on the left hand side of the vehicle



LADDER RACK only for Connect with rear leaf doors

Technical features,
see page 7

Order no. POS 301

Dimensions: **2110x1380 mm** (WxD)

Weight: **41,40 Kg**

Ladder rack complete with:

- 2 aluminium crossmembers with fixing connectors and rubber profile
- 1 additional crossmember with supports
- 1 2000 mm long aluminium side upstand
- 1 aluminium loading roller
- 1 ladder rack rail made from stainless steel and aluminium **TALENTO** series, length 2110 mm

Supplied with **stainless steel** screws for fixing.

Load capacity: 59 Kg (p.u.d.)



Technical features,
see page 5

Accessories
see page 9

*approximate
measurement

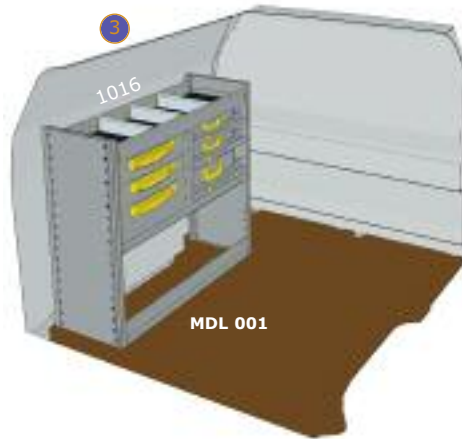
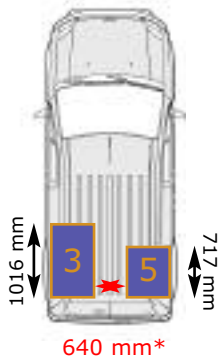

Layout example of LH side



Layout example of RH side



Suitable to be installed in the zone: **3**

Order no. MDL 008

Dimensions: **1016x365x900 mm** (WxDxH)

Weight: **41,7 Kg**

Module complete with:

- 1 tray with rubber and 3 adjustable dividers
- 2 drawers
- 1 shelf with door
- 1 hinged door



Suitable to be installed in the zone: **3**

Order no. MDL 009

Dimensions: **1016x365x900 mm** (WxDxH)

Weight: **25,4 Kg**

Module complete with:

- 3 trays with rubber and 9 adjustable dividers



Suitable to be installed in the zone: **3**

Order no. MDL 010

Dimensions: **1016x365x900 mm** (WxDxH)

Weight: **60,1 Kg**

Module complete with:

- 1 tray with rubber and 3 adjustable dividers
- 3 drawers
- 3 retractable shelves for tool cases complete with tool cases and boxes



Suitable to be installed in the zone: **5**

Order no. MDL 005

Dimensions: **717x365x900 mm** (WxDxH)

Weight: **32,9 Kg**

Module complete with:

- 1 tray with rubber and 2 adjustable dividers
- 2 drawers
- 1 shelf with door



Suitable to be installed in the zone: **5**

Order no. MDL 006

Dimensions: **717x365x900 mm** (WxDxH)

Weight: **22,7 Kg**

Module complete with:

- 3 trays with rubber and 6 adjustable dividers



Suitable to be installed in the zone: **5**

Order no. MDL 007

Dimensions: **717x365x900 mm** (WxDxH)

Weight: **42,7 Kg**

Module complete with:

- 3 trays with rubber and 6 adjustable dividers
- 1 retractable vice workbench complete with steel vice with 100 mm jaws and 1/2" to 1 1/2" pipe clamp



VERTICAL RETRACTABLE SYSTEMS DOUBLE LEVEL FLOOR



The vertical retractable systems and drawers placed under the loading floor make it easier to take out the stored material

Detail of the drawer installed by the right side door





Vertical retractable system

Order no. PEV 301

Vertical retractable system with module for double level floor kit

Dimensions: **1234x455x860 mm** (WxDxH)

Weight: **49,00 Kg**

System complete with:

- 1 vertical frame, extraction 50% load capacity 100 Kg, extraction 70% load capacity 75 Kg
- 1 module with 3 trays with rubber and 12 adjustable partitions

THE VERTICAL RETRACTABLE SYSTEM

can only be mounted together with the raised floor kit.



Double level floor kit

Order no. MPR 301

Dimensions:

1470x1613x267 mm (WxDxH)

Weight: **98,00 Kg**

Kit complete with:

- 1 12 mm thick wooden flooring phenolic coated
- 2 drawer cabinets with 4 drawers complete of partitioning material, internal dimensions of the drawers: 447x600x86 mm h
- 1 drawer cabinet with 1 drawer complete of partitioning material, internal dimensions of the drawer: 323x447x186 mm h

DOUBLE LEVEL FLOOR KIT

only for CONNECT with rear leaf doors and right hand side sliding door. Sheet metal bulkhead.



Detail of 2 drawers with useful height 86 mm, standard supplied with:
12 plastic boxes 150x150x71 mm h
24 plastic boxes 75x150x71 mm h



Detail of 2 drawers with useful height 86 mm, standard supplied with:
5 multi-purpose supports

Detail of drawer with useful height 186 mm, standard supplied with:
1 longitudinal divider





VERTICAL RETRACTABLE SYSTEMS



Vertical retractable system Order no. PEV 302

Vertical retractable system with module

Dimensions: 1234x355x1110 mm (WxDxH)

Weight: 55,90 Kg

Panel complete with:

- 1 vertical frame, extraction 50% load capacity 100 Kg, extraction 70% load capacity 75 Kg
- 1 module with 4 trays with rubber and 16 adjustable dividers

THE VERTICAL RETRACTABLE SYSTEM can only be mounted together with the wooden flooring order no. PIL 301.



The vertical retractable system makes it easier to take out the stored material



Module

Order no. MDL 006

Dimensions: 717x365x900 mm (WxDxH)

Weight: 22,7 Kg

Module complete with:

- 3 trays with rubber and 6 adjustable dividers

2,8 m³
L1 H1 wheelbase 2664 mm



TRANSIT CONNECT SWB
low roof

HORIZONTAL RETRACTABLE SYSTEMS



Horizontal retractable system

Order no. PEO 301

Dimensions: **1080x1524x80 mm** (WxDxH)

Weight: **71,45 Kg**

System complete with:

- 1 wooden flooring phenolic coated with holes for fixing the extractable frame
- 1 horizontal extractable frame extension 60% load capacity 300 Kg complete with a shelf in phenolic wooden top and rubber protection
- 8 lashing hooks supports for load retaining belt
- 2 load retaining belts



The horizontal retractable system makes it easier to anchor the material transported and makes loading, unloading operations simpler



FLOORINGS AND LININGS

for CONNECT with RH side sliding door and rear leaf doors, sheet metal side walls

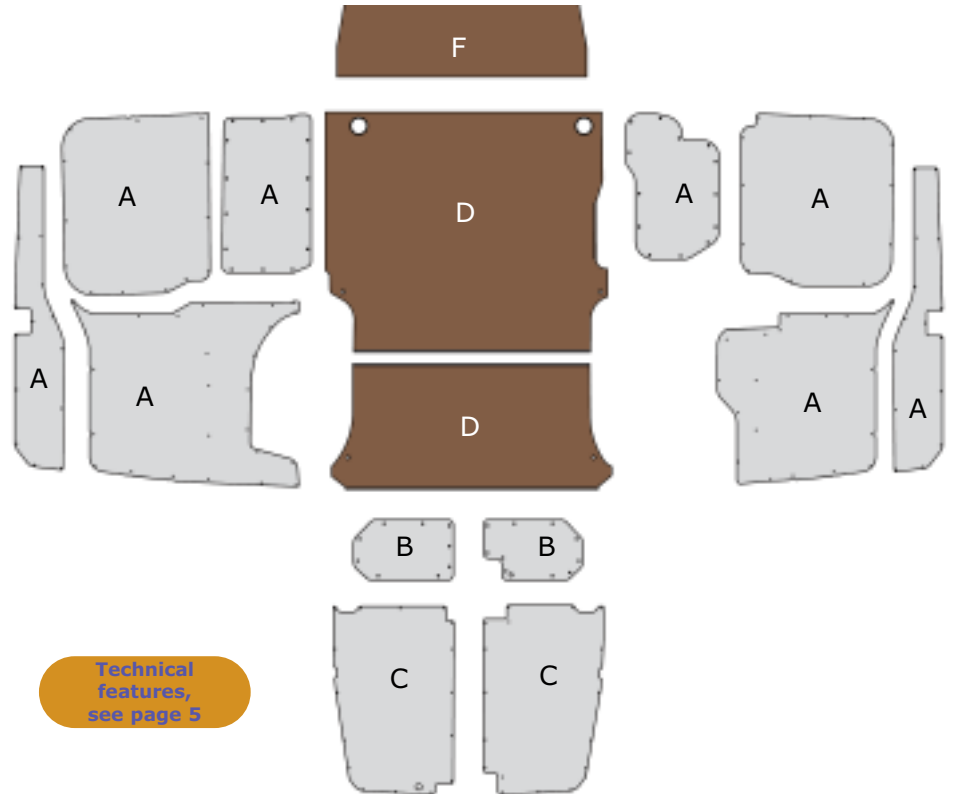

A + B Polypropylene linings Order no. PAN 302

Weight: **8,10 Kg**

Polypropylene linings for:

- LH side wall
- RH side wall and sliding door
- lower section of rear leaf doors

C Polypropylene linings Order no. PAR 302

Weight: **2,05 Kg**

Polypropylene linings for:

- upper section of rear leaf doors

D Flooring Order no. PIL 302

Weight: **21,00 Kg**

12 mm thick wooden flooring phenolic coated and predrilling for lashing hook supports.

F Bulkhead panel Order no. PIR 301

Weight: **3,90 Kg**

12 mm wooden phenolic coated bulkhead panel.

ROOF RACK



ROOF RACK only for Connect with rear leaf doors

Order no. POT 302

Dimensions: **2000x1400 mm** (WxD)

Weight: **19,70 Kg**

Roof rack complete with:

- 2 aluminium crossmembers with fixing connectors and rubber profile
- 1 additional crossmember with supports
- 2 2000 mm long aluminium side upstands
- 1 aluminium loading roller

Supplied with **stainless steel** screws for fixing.

Load capacity: 81 Kg (p.u.d.)

LADDER RACK

The ladder rack rail can be mounted on the right or on the left hand side of the vehicle



LADDER RACK only for Connect with rear leaf doors

Technical features,
see page 7

Order no. POS 302

Dimensions: **2110x1380 mm** (WxD)

Weight: **41,40 Kg**

Ladder rack complete with:

- 2 aluminium crossmembers with fixing connectors and rubber profile
- 1 additional crossmember with supports
- 1 2000 mm long aluminium side upstand
- 1 aluminium loading roller
- 1 ladder rack rail made from stainless steel and aluminium **TALENTO** series, length 2110 mm

Supplied with **stainless steel** screws for fixing.

Load capacity: 59 Kg (p.u.d.)

3,7 m³
L2 H2 wheelbase 2912 mm



TRANSIT CONNECT LWB
high roof

READY SOLUTIONS



MDL S10

Order no. MDL S10

Dimensions: **1524x365x1200 mm** (WxDxH). Weight: **39,45 Kg**

Module complete with:

- 3 trays with rubber and 15 adjustable dividers
- 1 fixing bar length 2000 mm



MDL 005

Order no. MDL 005

Dimensions: **717x365x900 mm** (WxDxH). Weight: **32,9 Kg**

Module complete with:

- 1 tray with rubber and 2 adjustable dividers
- 2 drawers
- 1 shelf with door





MODULES 508 MM



Suitable to be installed in the zone: **2**

Order no. MDL 040

Dimensions : **508x365x900 mm** (WxDxH)

Weight : **16,93 Kg**

Module complete with:

- 3 trays with rubber and 3 adjustable dividers



Suitable to be installed in the zone: **2**

Order no. MDL 041

Dimensions : **508x365x900 mm** (WxDxH)

Weight : **18,85 Kg**

- 1 tray with rubber and 1 adjustable dividers

- 1 shelf with door

- 1 connection bar with fixing belts for tool cases

MODULES 717 MM



Suitable to be installed in the zone: **5**

Order no. MDL 005

Dimensions: **717x365x900 mm** (WxDxH)

Weight: **32,9 Kg**

Module complete with:

- 1 tray with rubber and 2 adjustable dividers

- 2 drawers

- 1 shelf with door



Suitable to be installed in the zone: **5**

Order no. MDL 007

Dimensions: **717x365x900 mm** (WxDxH)

Weight: **42,7 Kg**

Module complete with:

- 3 trays with rubber and 6 adjustable dividers

- 1 retractable vice workbench complete with steel vice with 100 mm jaws and 1/2" to 1 1/2" pipe clamp



Suitable to be installed in the zone: **5**

Order no. MDL 006

Dimensions: **717x365x900 mm** (WxDxH)

Weight: **22,7 Kg**

Module complete with:

- 3 trays with rubber and 6 adjustable dividers

Technical features, see page 5

Accessories see page 9

*approximate measurement

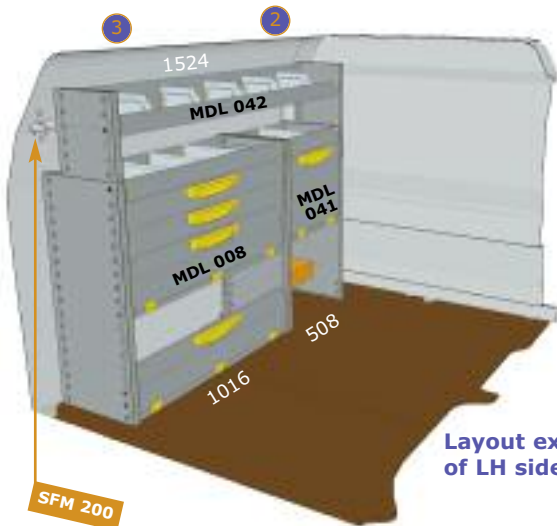
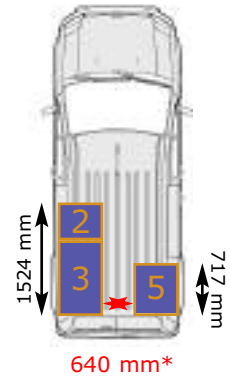

Layout example of LH side

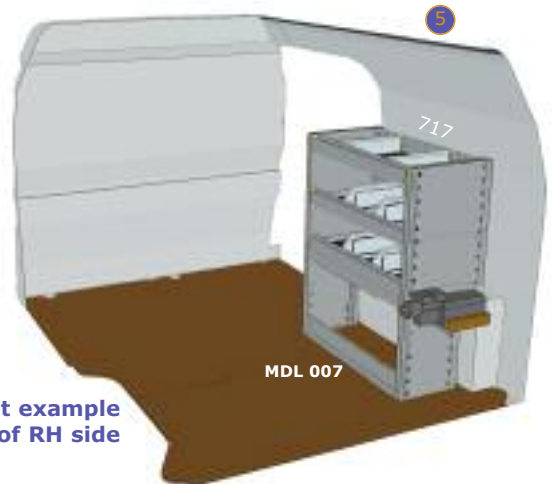

Layout example of RH side

3,7 m³
L2 H2 wheelbase 2912 mm



TRANSIT CONNECT LWB
high roof

MODULES 1016 MM



Suitable to be installed in the zone: **3**

Order no. MDL 008

Dimensions: **1016x365x900 mm** (WxDxH)

Weight: **41,7 Kg**

Module complete with:

- 1 tray with rubber and 3 adjustable dividers
- 2 drawers
- 1 shelf with door
- 1 hinged door



Suitable to be installed in the zone: **3**

Order no. MDL 009

Dimensions: **1016x365x900 mm** (WxDxH)

Weight: **25,4 Kg**

Module complete with:

- 3 trays with rubber and 9 adjustable dividers



Suitable to be installed in the zone: **3**

Order no. MDL 010

Dimensions: **1016x365x900 mm** (WxDxH)

Weight: **60,1 Kg**

Module complete with:

- 1 tray with rubber and 3 adjustable dividers
- 3 drawers
- 3 retractable shelves for tool cases complete with tool cases and boxes

ADD-ON MODULE 1524 MM



Suitable to be installed in the zone: **2 + 3**

Order no. MDL 042

Dimensions: **1524x265x300 mm** (WxDxH)

Weight: **9,90 Kg**

Module complete with:

- 1 tray with rubber and 5 adjustable dividers

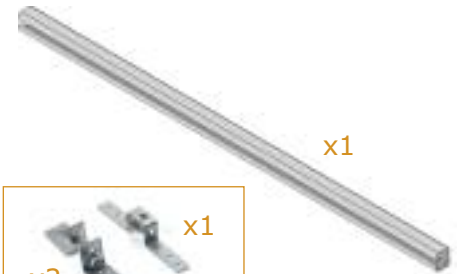

Order no. SFM 200

Fixing bar: **2000x30x35 mm** (WxDxH)

Weight: **1,88 Kg**

Fixing bar for upper modules, complete with brackets, bolts and screws.

The bar is necessary to fix the additional MDL 042 module to the vehicle.



Strategically strong



Transit L2 H2 - 7,78 m³

- › **FAST ASSEMBLY**
- › **TOTAL MODULARITY**
- › **SAFETY SOUND ABSORBING ELEMENTS BETWEEN THE VARIOUS METAL COMPONENTS**
- › **ERGONOMIC SHAPES**
- › **HEIGHT ADJUSTMENT IN PITCH OF 25 mm OF THE VARIOUS ELEMENTS**

Vehicle equipped with:

- 1 ord. no. POS 304 ladder rack (ladder not supplied)
- 1 ord. no. PIL 305 wooden flooring
- 1 ord. no. PAN 305 polypropylene linings
- 1 ord. no. PAR 305 polypropylene linings
- 1 ord. no. MDL 120 module
- 1 ord. no. MDL 123 module
- 1 ord. no. MDL 118 module
- 1 ord. no. SFM 150 fixing bar
- 1 ord. no. SFM 300 fixing bar
- 1 ord. no. ACS 001 hand washing kit
- 1 ord. no. ACS 004 first aid kit
- 1 ord. no. ACS 007 spray cans holder
- 1 ord. no. ACS 005 paper roll holder with paper roll
- 1 ord. no. ACS 003 support with belt for gas cylinders and extinguishers (extinguisher not supplied)



TRANSIT





FLOORINGS AND LININGS

for TRANSIT with RH side sliding door and rear leaf doors, sheet metal side walls

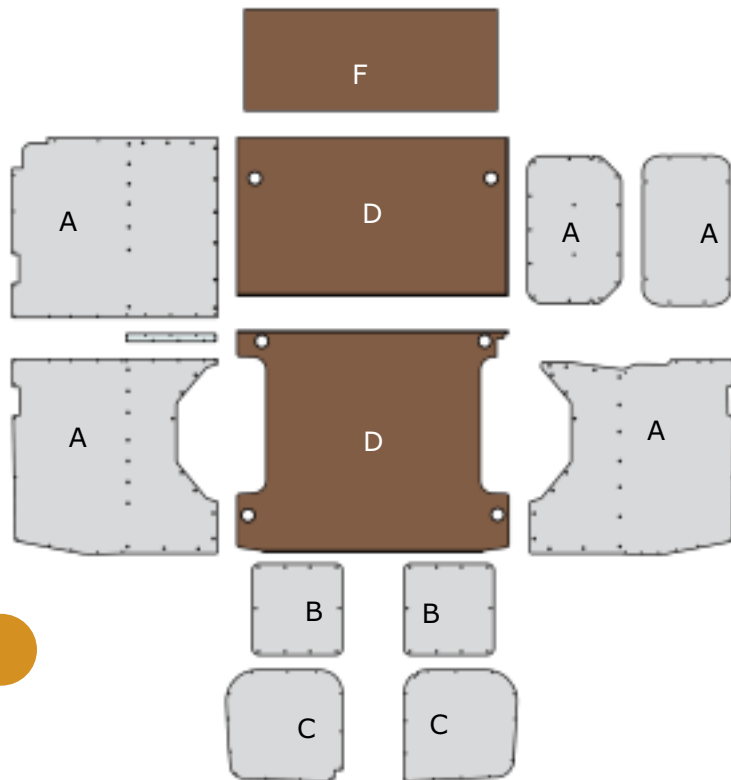
A + B Polypropylene linings
Order no. PAN 303

Weight: **11,80 Kg**

Polypropylene linings for:

- LH side wall
- RH side wall and sliding door
- lower section of rear leaf doors

Technical features,
see page 5

C Polypropylene linings
Order no. PAR 303

Weight: **1,90 Kg**

Polypropylene linings for:

- upper section of rear leaf doors

D Flooring
Order no. PIL 303

Weight: **34,00 Kg**

12 mm thick wooden flooring phenolic coated and predrilling for lashing hook supports.

F Bulkhead
Order no. PIR 302

Weight: **8,40 Kg**

12 mm wooden phenolic coated bulkhead panel.

ROOF RACK

Order no. POT 303

Dimensions: **3000x1800 mm (WxD)**

Weight: **33,50 Kg**

Roof rack complete with:

- 3 aluminium crossmembers with fixing connectors and rubber profile
- 2 aluminium bars
- 2 3000 mm long aluminium side upstands
- 1 aluminium loading roller

Supplied with **stainless steel** screws for fixing.

Load capacity: 117 Kg (p.u.d.)

Technical features,
see page 7

LADDER RACK

The ladder rack rail can be mounted on the right or on the left hand side of the vehicle

Order no. POS 303

Dimensions: **3240x1780 mm (WxD)**

Weight: **52,50 Kg**

Ladder rack complete with:

- 3 aluminium crossmembers with fixing connectors and rubber profile
- 1 3000 mm long aluminium side upstand
- 1 aluminium loading roller
- 1 ladder rack rail made from stainless steel and aluminium **TALENTO** series, length 3240 mm

Supplied with **stainless steel** screws for fixing.

Load capacity: 98 Kg (p.u.d.)

5,62 m³
L1 H1 wheelbase 2933 mm



TRANSIT VAN SWB
low roof front-wheel drive

LOADING RAMP

Order no. RAM 301

Dimensions: **1050x2200 mm** (WxD)
Weight: **94,55 Kg**

Swivel loading ramp.

Load capacity: **1000 Kg**
(p.u.d.)



If the loading ramp is fitted, the MDL series modules for areas **3** and **5** cannot be installed.
If you wish to install modules in areas **3** and **5** you need to ask your nearest STORE VAN distributor for a project feasibility study.

Technical
features,
see page 8

READY SOLUTIONS



Order no. MDL 030

Dimensions: **2032x365x1200 mm** (WxDxH). Weight: **45,15 Kg**
Module complete with:
3 trays with rubber and 15 adjustable dividers



Order no. MDL 015

Dimensions: **1016x365x1200 mm** (WxDxH). Weight: **48,3 Kg**
Module complete with:
3 trays with rubber and 9 adjustable dividers
1 drawer
1 retractable shelf for tool cases complete with tool cases and boxes



MODULES 1016 mm

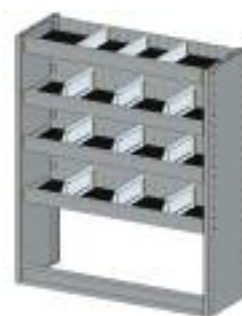
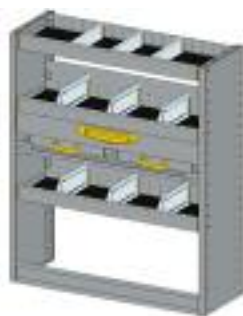

Suitable to be installed in the zone: **2 3 5**

Order no. MDL 014

Dimensions: **1016x365x1200 mm** (WxDxH)

Weight: **49,4 Kg**

Module complete with:

- 2 trays with rubber and 6 adjustable dividers
- 2 drawers
- 1 shelf with door
- 1 hinged door

Suitable to be installed in the zone: **2 3 5**

Order no. MDL 015

Dimensions: **1016x365x1200 mm** (WxDxH)

Weight: **48,3 Kg**

Module complete with:

- 3 trays with rubber and 9 adjustable dividers
- 1 drawer
- 1 retractable shelf for tool cases complete with tool cases and boxes

Suitable to be installed in the zone: **2 3 5**

Order no. MDL 016

Dimensions: **1016x365x1200 mm** (WxDxH)

Weight: **33,2 Kg**

Module complete with:

- 4 trays with rubber and 12 adjustable dividers

Technical features, see page 5
Accessories see page 9

*approximate measurement

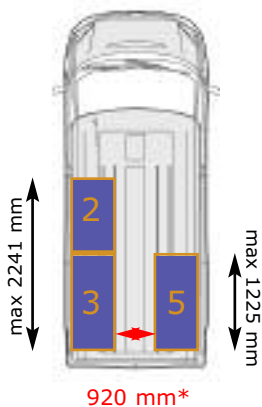

Suitable to be installed in the zone: **2**

Order no. MDL 017

Dimensions: **1016x365x1200 mm** (WxDxH)

Weight: **33 Kg**

Module complete with:

- 2 trays with rubber and 6 adjustable dividers
- 1 shelf with door
- 1 connection bar with fixing belts for tool cases

Suitable to be installed in the zone: **5**

Order no. MDL 018

Dimensions: **1016x365x1200 mm** (WxDxH)

Weight: **57,5 Kg**

Module complete with:

- 4 trays with rubber and 12 adjustable dividers
- 1 retractable vice workbench complete with steel vice with 100 mm jaws and 1/2" to 1 1/2" pipe clamp

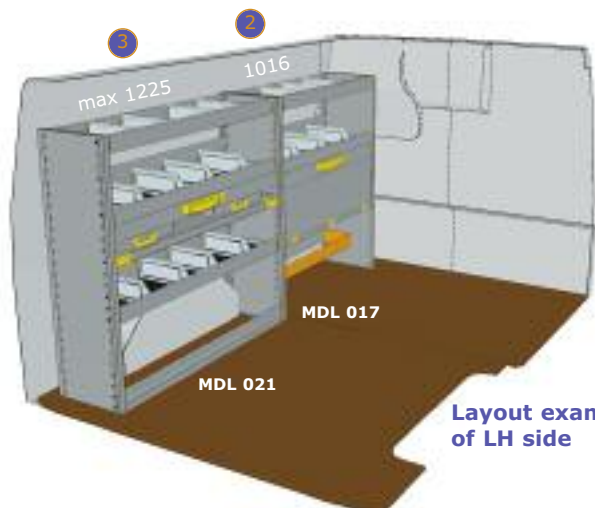

Layout example of LH side

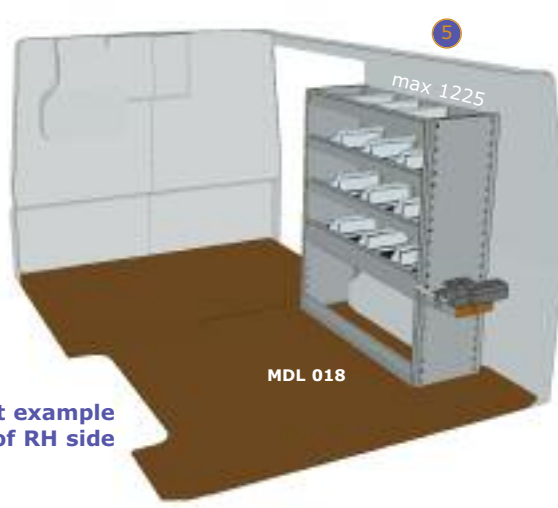

Layout example of RH side

5,62 m³
L1 H1 wheelbase 2933 mm



TRANSIT VAN SWB
low roof front-wheel drive

MODULES 1225 mm



Suitable to be installed in the zone: **3 5**

Order no. MDL 020

Dimensions: **1225x365x1200 mm** (WxDxH)

Weight: **57,35 Kg**

Module complete with:

- 2 trays with rubber and 8 adjustable dividers
- 2 drawers
- 1 shelf with door
- 1 hinged door



Suitable to be installed in the zone: **3 5**

Order no. MDL 021

Dimensions: **1225x365x1200 mm** (WxDxH)

Weight: **55,35 Kg**

Module complete with:

- 3 trays with rubber and 12 adjustable dividers
- 1 drawer
- 1 retractable shelf for tool cases complete with tool cases and boxes



Suitable to be installed in the zone: **3 5**

Order no. MDL 022

Dimensions: **1225x365x1200 mm** (WxDxH)

Weight: **39,40 Kg**

Module complete with:

- 4 trays with rubber and 16 adjustable dividers



FLOORINGS AND LININGS

for **TRANSIT** with RH and LH sliding doors, rear leaf doors, sheet metal side walls

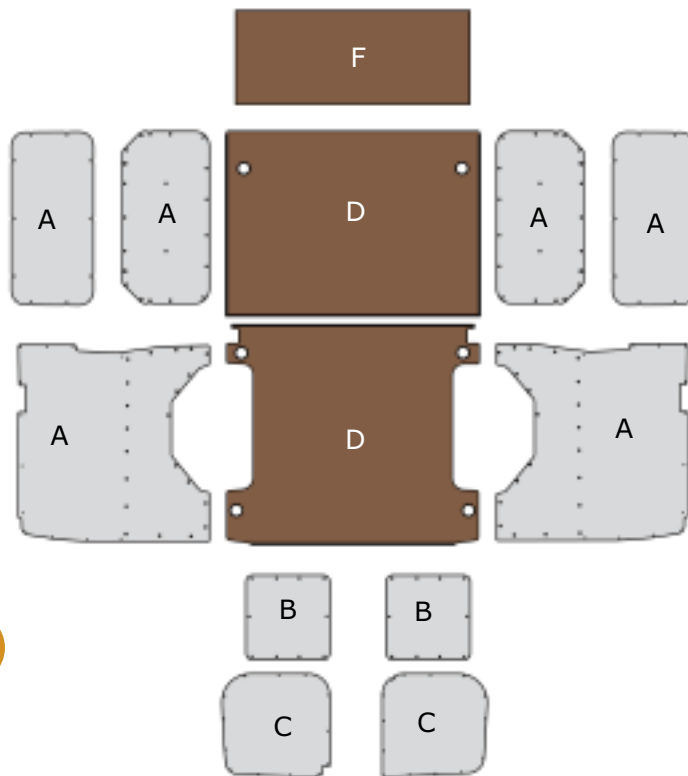
A + B Polypropylene linings
Order no. PAN 304

Weight: **12,45 Kg**

Polypropylene linings for:

- LH side wall and sliding door
- RH side wall and sliding door
- lower section of rear leaf doors

Technical features, see page 5

C Polypropylene linings
Order no. PAR 303

Weight: **1,90 Kg**

Polypropylene linings for:

- upper section of rear leaf doors

D Flooring
Order no. PIL 304

Weight: **39,50 Kg**

12 mm thick wooden flooring phenolic coated and predrilling for lashing hook supports.

F Bulkhead
Order no. PIR 302

Weight: **8,40 Kg**

12 mm wooden phenolic coated bulkhead panel.

ROOF RACK

Order no. POT 303

Dimensions: **3000x1800 mm** (WxD)

Weight: **33,50 Kg**

Roof rack complete with:

- 3 aluminium crossmembers with fixing connectors and rubber profile
- 2 aluminium bars
- 2 3000 mm long aluminium side upstands
- 1 aluminium loading roller

Supplied with **stainless steel** screws for fixing.

Load capacity: 117 Kg (p.u.d.)

Technical features, see page 7

LADDER RACK

The ladder rack rail can be mounted on the right or on the left hand side of the vehicle

Order no. POS 303

Dimensions: **3240x1780 mm** (WxD)

Weight: **52,50 Kg**

Ladder rack complete with:

- 3 aluminium crossmembers with fixing connectors and rubber profile
- 1 3000 mm long aluminium side upstand
- 1 aluminium loading roller
- 1 ladder rack rail made from stainless steel and aluminium **TALENTO** series, length 3240 mm

Supplied with **stainless steel** screws for fixing.

Load capacity: 98 Kg (p.u.d.)

6,45 m³
L2 H1 wheelbase 3300 mm



TRANSIT VAN MWB
low roof front-wheel drive

LOADING RAMP

Order no. RAM 301

Dimensions: **1050x2200 mm** (WxD)

Weight: **94,55 Kg**

Swivel loading ramp.

Load capacity: 1000 Kg (p.u.d.)

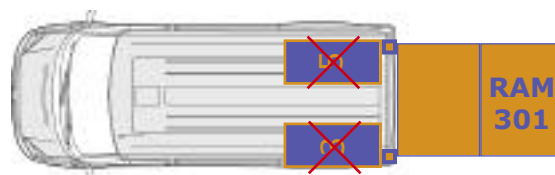

If the loading ramp is fitted, the MDL series modules for areas **3** and **5** cannot be installed. If you wish to install modules in areas **3** and **5** you need to ask your nearest STORE VAN distributor for a project feasibility study.

Technical
features,
see page 8





MODULES 1016 mm

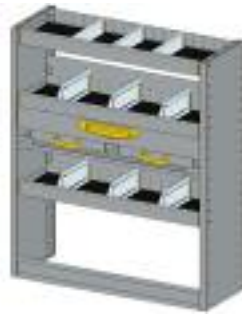

Suitable to be installed in the zone: **3 5**

Order no. MDL 014

Dimensions: **1016x365x1200 mm** (WxDxH)

Weight: **49,4 Kg**

Module complete with:

- 2 trays with rubber and 6 adjustable dividers
- 2 drawers
- 1 shelf with door
- 1 hinged door

Suitable to be installed in the zone: **3 5**

Order no. MDL 015

Dimensions: **1016x365x1200 mm** (WxDxH)

Weight: **48,3 Kg**

Module complete with:

- 3 trays with rubber and 9 adjustable dividers
- 1 drawer
- 1 retractable shelf for tool cases complete with tool cases and boxes

Suitable to be installed in the zone: **3 5**

Order no. MDL 016

Dimensions: **1016x365x1200 mm** (WxDxH)

Weight: **33,2 Kg**

Module complete with:

- 4 trays with rubber and 12 adjustable dividers

*approximate measurement

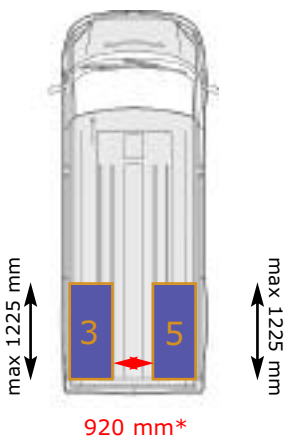

Technical features, see page 5
Accessories see page 9



Suitable to be installed in the zone: **5**

Order no. MDL 018

Dimensions: **1016x365x1200 mm** (WxDxH)

Weight: **57,5 Kg**

Module complete with:

- 4 trays with rubber and 12 adjustable dividers
- 1 retractable vice workbench complete with steel vice with 100 mm jaws and 1/2" to 1 1/2" pipe clamp

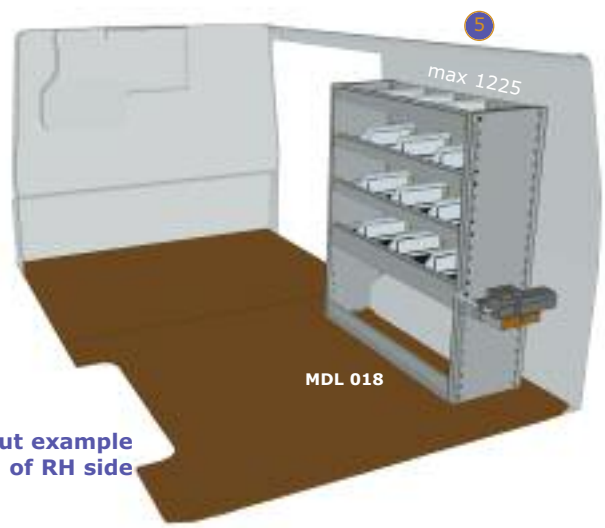

Layout example of LH side

Layout example of RH side

6,45 m³
L2 H1 wheelbase 3300 mm



TRANSIT VAN MWB
low roof front-wheel drive

MODULES 1225 mm



Suitable to be installed in the zone: **3 5**

Order no. MDL 020

Dimensions: **1225x365x1200 mm** (WxDxH)

Weight: **57,35 Kg**

Module complete with:

- 2 trays with rubber and 8 adjustable dividers
- 2 drawers
- 1 shelf with door
- 1 hinged door



Suitable to be installed in the zone: **3 5**

Order no. MDL 021

Dimensions: **1225x365x1200 mm** (WxDxH)

Weight: **55,35 Kg**

Module complete with:

- 3 trays with rubber and 12 adjustable dividers
- 1 drawer
- 1 retractable shelf for tool cases complete with tool cases and boxes



Suitable to be installed in the zone: **3 5**

Order no. MDL 022

Dimensions: **1225x365x1200 mm** (WxDxH)

Weight: **39,40 Kg**

Module complete with:

- 4 trays with rubber and 16 adjustable dividers

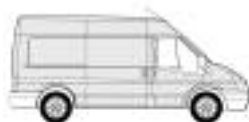
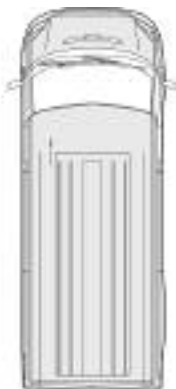

FLOORINGS AND LININGS

for **TRANSIT** with RH lateral sliding door and rear leaf doors, sheet metal clad walls

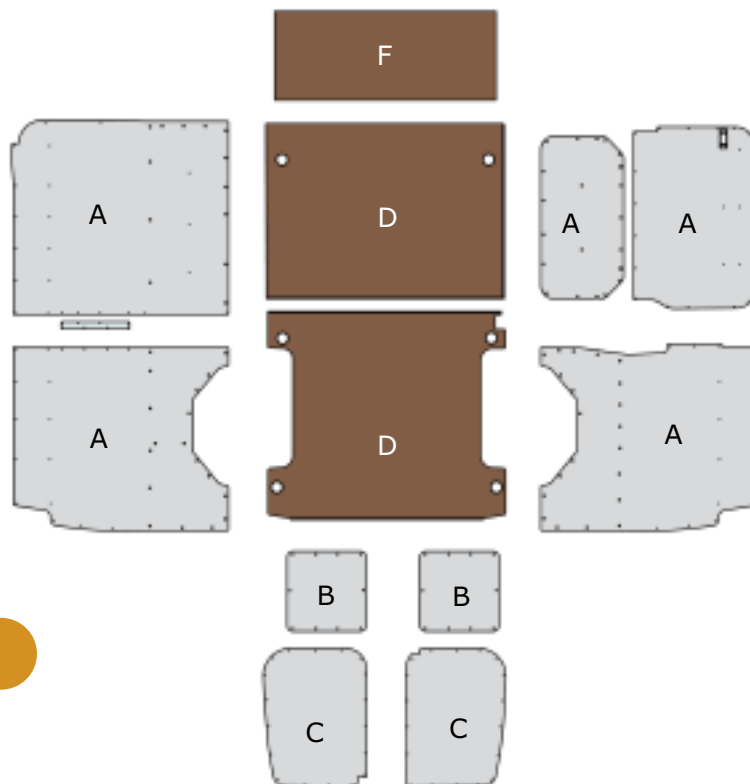
A + B Polypropylene linings
Order no. PAN 305

Weight: **16,30 Kg**

Polypropylene linings for:

- LH side wall
- RH side wall and sliding door
- lower section of rear leaf doors

Technical features,
see page 5

C Polypropylene linings
Order no. PAR 304

Weight: **2,70 Kg**

Polypropylene linings for:

- upper section of rear leaf doors

D Flooring
Order no. PIL 305

Weight: **39,45 Kg**

12 mm thick wooden flooring phenolic coated and predrilling for lashing hook supports.

F Bulkhead
Order no. PIR 302

Weight: **8,40 Kg**

12 mm wooden phenolic coated bulkhead panel.

ROOF RACK

Order no. POT 304

Dimensions: **3000x1700 mm** (WxD)

Weight: **32,50 Kg**

Roof rack complete with:

- 3 aluminium crossmembers with fixing connectors and rubber profile
- 2 aluminium bars
- 2 3000 mm long aluminium side upstands
- 1 aluminium loading roller

Supplied with **stainless steel** screws for fixing.

Load capacity: 118 Kg (p.u.d.)

Technical features,
see page 7

LADDER RACK

The ladder rack rail can be mounted on the right or on the left hand side of the vehicle

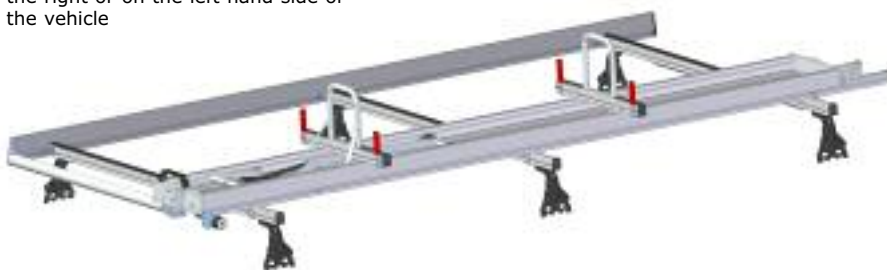
Order no. POS 304

Dimensions: **3240x1680 mm** (WxD)

Weight: **56,00 Kg**

Ladder rack complete with:

- 3 aluminium crossmembers with fixing connectors and rubber profile
- 1 3000 mm long aluminium side upstand
- 1 aluminium loading roller
- 1 ladder rack rail made from stainless steel and aluminium **ALADIN** series, length 3240 mm

Supplied with **stainless steel** screws for fixing.

Load capacity: 94 Kg (p.u.d.)

7,78 m³
L2 H2 wheelbase 3300 mm



TRANSIT VAN MWB
medium roof front-wheel drive

LOADING RAMP

Order no. RAM 302

Dimensions: **1150x2500 mm** (WxD)
Weight: **111,50 Kg**

Swivel loading ramp.

Load capacity: **1000 Kg** (p.u.d.)



If the loading ramp is fitted, the MDL series modules for areas **3** and **5** cannot be installed. If you wish to install modules in areas **3** and **5** you need to ask your nearest STORE VAN distributor for a project feasibility study.

Technical
features,
see page 8

READY SOLUTIONS



Order no. MDL S11

Dimensions: **2032x365x1500 mm** (WxDxH). Weight: **58,95 Kg**

Module complete with:

- 4 trays with rubber and 20 adjustable dividers
- 1 fixing bar length 3000 mm



Order no. MDL S12

Dimensions: **1016x365x1500 mm** (WxDxH). Weight: **58,65 Kg**

Module complete with:

- 3 trays with rubber and 9 adjustable dividers
- 2 drawers
- 1 shelf with door
- 1 hinged door
- 1 fixing bar length 1500 mm



MODULES 1016 MM



Suitable to be installed in the zone: **2 3 5**

Order no. MDL 114

Dimensions: **1016x365x1700 mm** (WxDxH)

Weight: **62,90 Kg**

Module complete with:

- 4 trays with rubber and 12 adjustable dividers
- 2 drawers
- 1 shelf with door
- 1 hinged door

Suitable to be installed in the zone: **2 3 5**

Order no. MDL 115

Dimensions: **1016x365x1700 mm** (WxDxH)

Weight: **61,80 Kg**

Module complete with:

- 5 trays with rubber and 15 adjustable dividers
- 1 drawer
- 1 retractable shelf for tool cases complete with tool cases and boxes

Suitable to be installed in the zone: **2 3 5**

Order no. MDL 116

Dimensions: **1016x365x1700 mm** (WxDxH)

Weight: **46,70 Kg**

Module complete with:

- 6 trays with rubber and 18 adjustable dividers

*approximate measurement

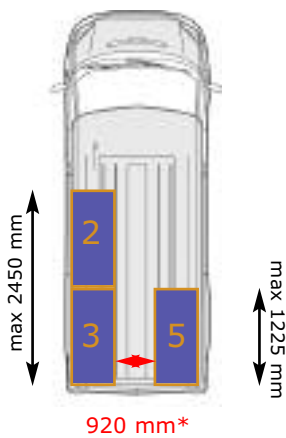

Suitable to be installed in the zone: **2**

Order no. MDL 117

Dimensions: **1016x365x1700 mm** (WxDxH)

Weight: **46,50 Kg**

Module complete with:

- 4 trays with rubber and 12 adjustable dividers
- 1 shelf with door
- 1 connection bar with fixing belts for tool cases

Suitable to be installed in the zone: **5**

Order no. MDL 118

Dimensions: **1016x365x1700 mm** (WxDxH)

Weight: **71,00 Kg**

Module complete with:

- 6 trays with rubber and 18 adjustable dividers
- 1 retractable vice workbench complete with steel vice with 100 mm jaws and 1/2" to 1 1/2" pipe clamp

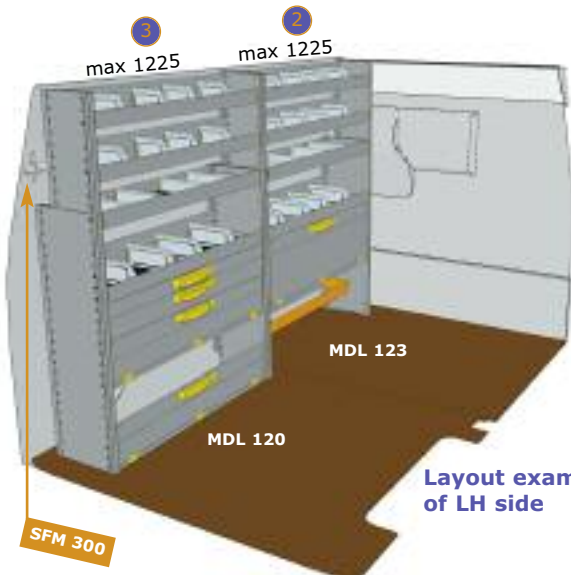

Layout example of LH side

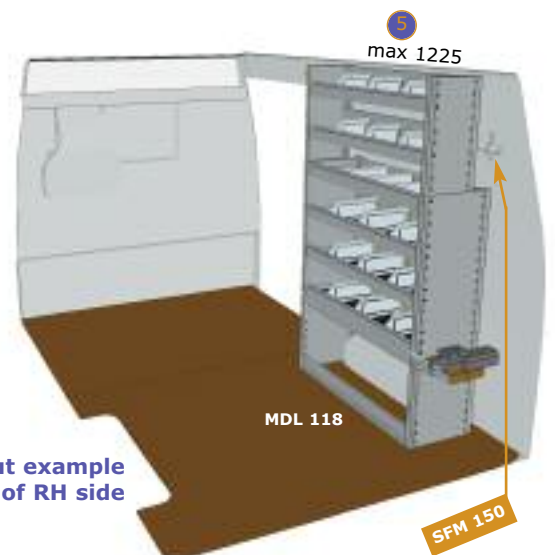

Layout example of RH side

7,78 m³
L2 H2 wheelbase 3300 mm



TRANSIT VAN MWB
medium roof front-wheel drive

MODULES 1225 MM



Suitable to be installed in the zone: **2 3 5**

Order no. MDL 120

Dimensions: **1225x365x1700 mm** (WxDxH)

Weight: **72,95 Kg**

Module complete with:

- 4 trays with rubber and 16 adjustable dividers
- 2 drawers
- 1 shelf with door
- 1 hinged door



Suitable to be installed in the zone: **2 3 5**

Order no. MDL 121

Dimensions: **1225x365x1700 mm** (WxDxH)

Weight: **70,95 Kg**

Module complete with:

- 5 trays with rubber and 20 adjustable dividers
- 1 drawer
- 1 retractable shelf for tool cases complete with tool cases and boxes



Suitable to be installed in the zone: **2 3 5**

Order no. MDL 122

Dimensions: **1225x365x1700 mm** (WxDxH)

Weight: **55,00 Kg**

Module complete with:

- 6 trays with rubber and 24 adjustable dividers



Suitable to be installed in the zone: **2**

Order no. MDL 123

Dimensions: **1225x365x1700 mm** (WxDxH)

Weight: **54,65 Kg**

Module complete with:

- 4 trays with rubber and 16 adjustable dividers
- 1 shelf with door
- 1 connection bar with fixing belts for tool cases

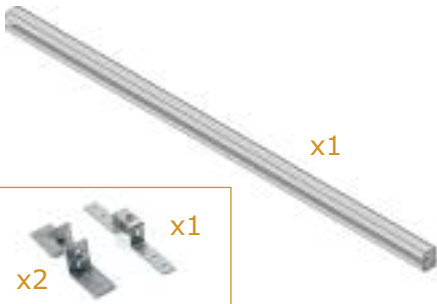

x1

x2

x1

Order no. SFM 300

Fixing bar: **3000x30x35 mm** (WxDxH)

Weight: **2,60 Kg**

Fixing bar for modules, complete with brackets, bolts and screws.

The bar is necessary to fix the modules to the vehicle.

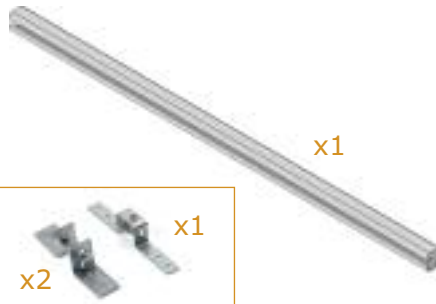

x1

x2

x1

Order no. SFM 150

Fixing bar: **1500x30x35 mm** (WxDxH)

Weight: **1,55 Kg**

Fixing bar for modules, complete with brackets, bolts and screws.

The bar is necessary to fix the modules to the vehicle.

Technical features,
see page 5

Accessories
see page 9



FLOORINGS AND LININGS



for **TRANSIT** with RH side sliding door and rear leaf doors, sheet metal side walls

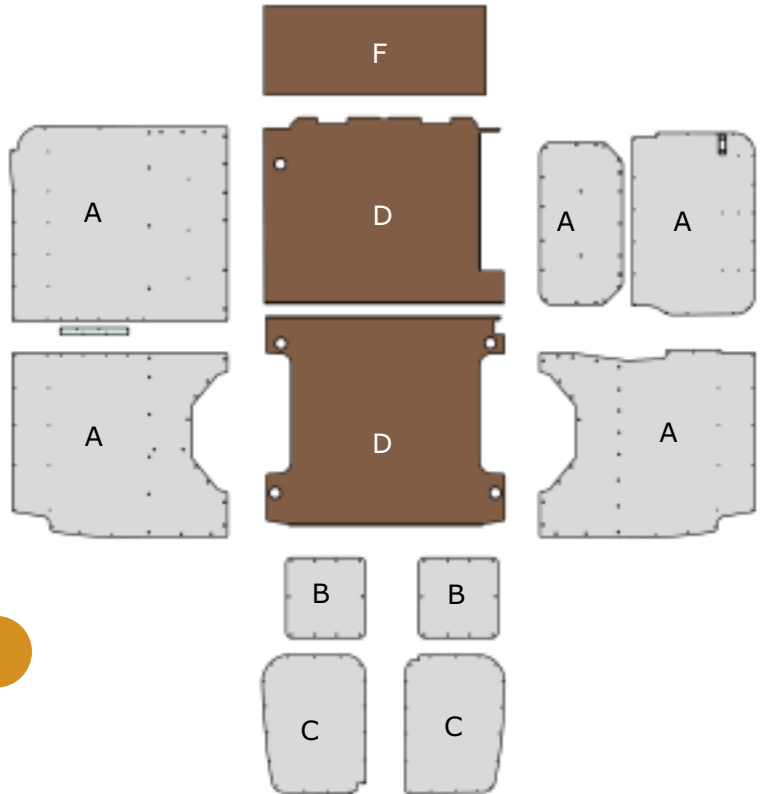

A + B Polypropylene linings Order no. PAN 305

Weight: **16,30 Kg**

Polypropylene linings for:

- LH side wall
- RH side wall and sliding door
- lower section of rear leaf doors

Technical features,
see page 5

C Polypropylene linings Order no. PAR 304

Weight: **2,70 Kg**

Polypropylene linings for:

- upper section of rear leaf doors

D Flooring Order no. PIL 306

Weight: **38,65 Kg**

12 mm thick wooden flooring phenolic coated and predrilling for lashing hook supports.

F Bulkhead Order no. PIR 303

Weight: **7,35 Kg**

12 mm wooden phenolic coated bulkhead panel.

ROOF RACK



Order no. POT 304

Dimensions: **3000x1700 mm** (WxD)

Weight: **32,50 Kg**

Roof rack complete with:

- 3 aluminium crossmembers with fixing connectors and rubber profile
- 2 aluminium bars
- 2 3000 mm long aluminium lateral profile
- 1 aluminium loading roller

Supplied with **stainless steel** screws for fixing.

Load capacity: 118 Kg (p.u.d.)

Technical features,
see page 7

LADDER RACK

The ladder rack rail can be mounted on the right or on the left hand side of the vehicle



Order no. POS 304

Dimensions: **3240x1680 mm** (WxD)

Weight: **56,00 Kg**

Ladder rack complete with:

- 3 aluminium crossmembers with fixing connectors and rubber profile
- 1 3000 mm long aluminium side upstand
- 1 aluminium loading roller
- 1 ladder rack rail made from stainless steel and aluminium **ALADIN** series, length 3240 mm

Supplied with **stainless steel** screws for fixing.

Load capacity: 94 Kg (p.u.d.)

7,34 m³
L2 H2 wheelbase 3300 mm



TRANSIT VAN MWB
medium roof rear-wheel drive

LOADING RAMP

Order no. RAM 302

Dimensions: **1150x2500 mm** (WxD)
Weight: **111,50 Kg**

Swivel loading ramp.

Load capacity: **1000 Kg** (p.u.d.)



If the loading ramp is fitted, the MDL series modules for areas **3** and **5** cannot be installed.
If you wish to install modules in areas **3** and **5** you need to ask your nearest STORE VAN distributor for a project feasibility study.

Technical
features,
see page 8

READY SOLUTIONS



Order no. MDL S11

Dimensions: **2032x365x1500 mm** (WxDxH). Weight: **58,95 Kg**

Module complete with:

- 4 trays with rubber and 20 adjustable dividers
- 1 fixing bar length 3000 mm



Order no. MDL S12

Dimensions: **1016x365x1500 mm** (WxDxH). Weight: **58,65 Kg**

Module complete with:

- 3 trays with rubber and 9 adjustable dividers
- 2 drawers
- 1 shelf with door
- 1 hinged door
- 1 fixing bar length 1500 mm

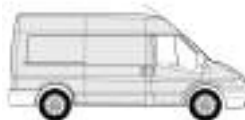

MODULES 1016 MM



Suitable to be installed in the zone: **2 3 5**

Order no. MDL 214

Dimensions: **1016x365x1500 mm** (WxDxH)

Weight: **57,10 Kg**

Module complete with:

- 3 trays with rubber and 9 adjustable dividers
- 2 drawers
- 1 shelf with door
- 1 hinged door

Suitable to be installed in the zone: **2 3 5**

Order no. MDL 215

Dimensions: **1016x365x1500 mm** (WxDxH)

Weight: **56,00 Kg**

Module complete with:

- 4 trays with rubber and 12 adjustable dividers
- 1 drawer
- 1 retractable shelf for tool cases complete with tool cases and boxes

Suitable to be installed in the zone: **2 3 5**

Order no. MDL 216

Dimensions: **1016x365x1500 mm** (WxDxH)

Weight: **40,90 Kg**

Module complete with:

- 5 trays with rubber and 15 adjustable dividers

*approximate measurement

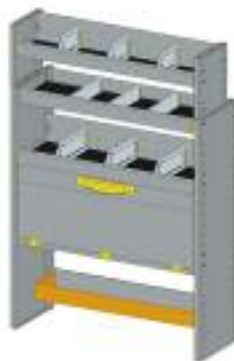
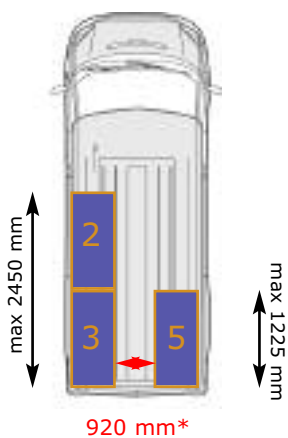

Suitable to be installed in the zone: **2**

Order no. MDL 217

Dimensions: **1016x365x1500 mm** (WxDxH)

Weight: **40,70 Kg**

Module complete with:

- 3 trays with rubber and 9 adjustable dividers
- 1 shelf with door
- 1 connection bar with fixing belts for tool cases

Suitable to be installed in the zone: **5**

Order no. MDL 218

Dimensions: **1016x365x1500 mm** (WxDxH)

Weight: **65,20 Kg**

Module complete with:

- 5 trays with rubber and 15 adjustable dividers
- 1 retractable vice workbench complete with steel vice with 100 mm jaws and 1/2" to 1 1/2" pipe clamp

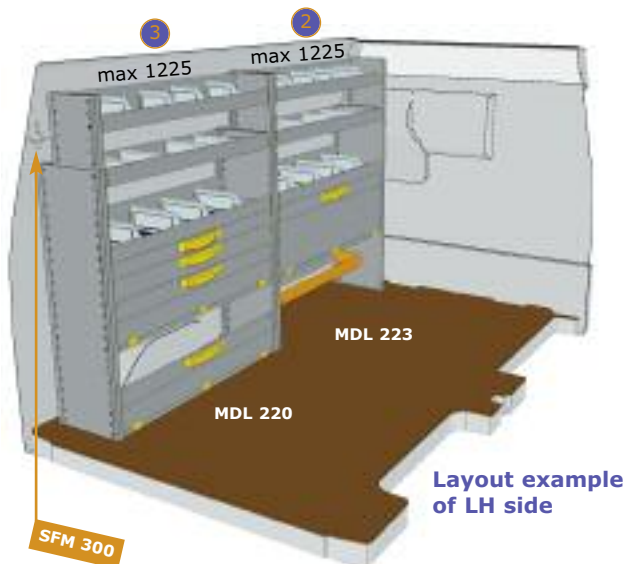

Layout example of LH side

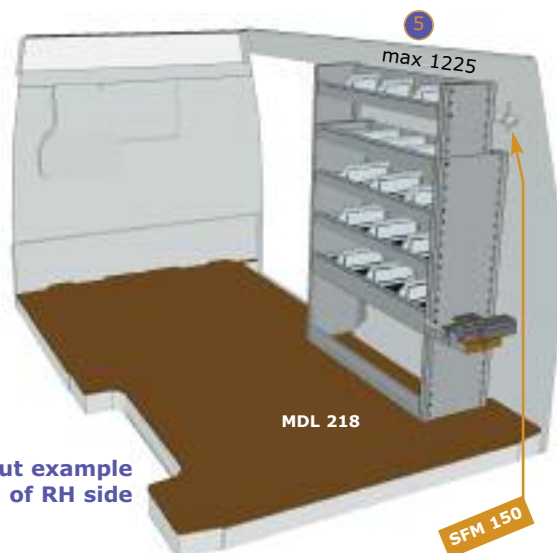

Layout example of RH side

7,34 m³
L2 H2 wheelbase 3300 mm

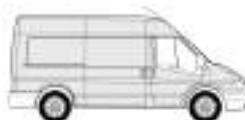

TRANSIT VAN MWB
medium roof rear-wheel drive

MODULES 1225 MM



Suitable to be installed in the zone: **2 3 5**

Order no. MDL 220

Dimensions: **1225x365x1500 mm** (WxDxH)

Weight: **66,10 Kg**

Module complete with:

- 3 trays with rubber and 12 adjustable dividers
- 2 drawers
- 1 shelf with door
- 1 hinged door



Suitable to be installed in the zone: **2 3 5**

Order no. MDL 221

Dimensions: **1225x365x1500 mm** (WxDxH)

Weight: **64,10 Kg**

Module complete with:

- 4 trays with rubber and 16 adjustable dividers
- 1 drawer
- 1 retractable shelf for tool cases complete with tool cases and boxes



Suitable to be installed in the zone: **2 3 5**

Order no. MDL 222

Dimensions: **1225x365x1500 mm** (WxDxH)

Weight: **48,15 Kg**

Module complete with:

- 5 trays with rubber and 20 adjustable dividers



Suitable to be installed in the zone: **2**

Order no. MDL 223

Dimensions: **1225x365x1500 mm** (WxDxH)

Weight: **47,80 Kg**

Module complete with:

- 3 trays with rubber and 12 adjustable dividers
- 1 shelf with door
- 1 connection bar with fixing belts for tool cases

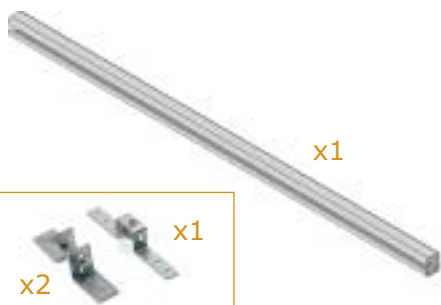

Order no. SFM 300

Fixing bar: **3000x30x35 mm** (WxDxH)

Weight: **2,60 Kg**

Fixing bar for modules, complete with brackets, bolts and screws.

The bar is necessary to fix the modules to the vehicle.



Order no. SFM 150

Fixing bar: **1500x30x35 mm** (WxDxH)

Weight: **1,55 Kg**

Fixing bar for modules, complete with brackets, bolts and screws.

The bar is necessary to fix the modules to the vehicle.

Technical
features,
see page 5

Accessories
see page 9



FLOORINGS AND LININGS

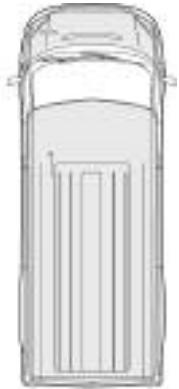

for **TRANSIT** with RH lateral sliding door and rear leaf doors, sheet metal side walls

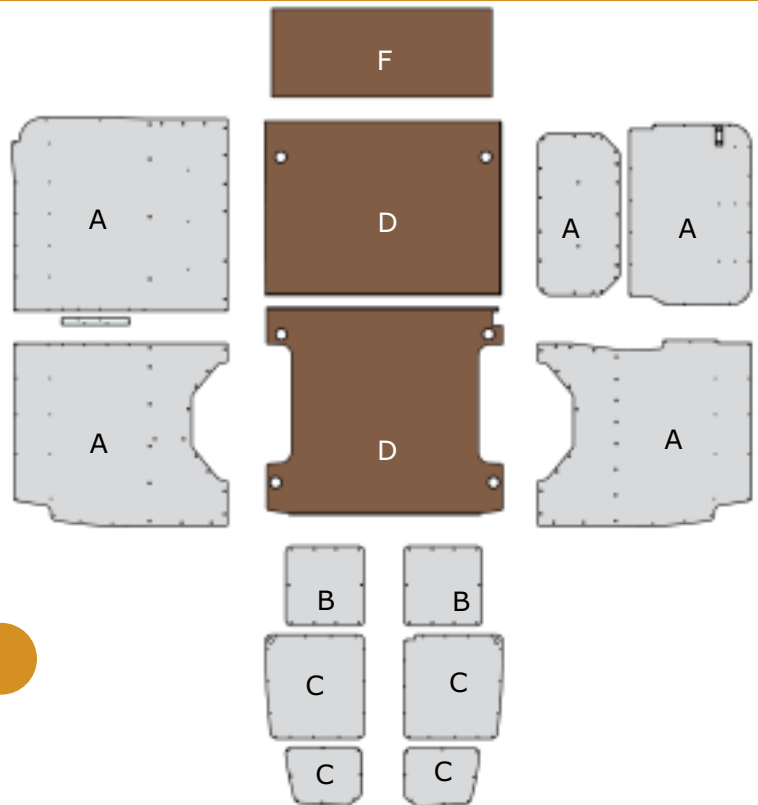

A + B Polypropylene linings Order no. PAN 305

Weight: **16,30 Kg**

Polypropylene linings for:

- LH side wall
- RH side wall and sliding door
- lower section of rear leaf doors

Technical features,
see page 5

C Polypropylene linings Order no. PAR 305

Weight: **2,90 Kg**

Polypropylene linings for:

- upper section of rear leaf doors

D Flooring Order no. PIL 305

Weight: **39,45 Kg**

12 mm thick wooden flooring phenolic coated and predrilling for lashing hook supports.

F Bulkhead Order no. PIR 302

Weight: **8,40 Kg**

12 mm wooden phenolic coated bulkhead panel.

ROOF RACK



Order no. POT 305

Dimensions: **2750x1700 mm** (WxD)

Weight: **29,80 Kg**

Roof rack complete with:

- 3 aluminium crossmembers with fixing connectors and rubber profile
- 2 aluminium bars
- 2 2750 mm long aluminium side upstands
- 1 aluminium loading roller

Supplied with **stainless steel** screws for fixing.

Load capacity: 121 Kg (p.u.d.)

Technical features,
see page 7

LADDER RACK

The ladder rack rail can be mounted on the right or on the left hand side of the vehicle



Order no. POS 305

Dimensions: **3240x1680 mm** (WxD)

Weight: **54,60 Kg**

Ladder rack complete with:

- 3 aluminium crossmembers with fixing connectors and rubber profile
- 1 2750 mm long aluminium side upstand
- 1 aluminium loading roller
- 1 ladder rack rail made from stainless steel and aluminium **ALADIN** series, length 3240 mm

Supplied with **stainless steel** screws for fixing.

Load capacity: 95 Kg (p.u.d.)

8,85 m³
L2 H3 wheelbase 3300 mm



TRANSIT VAN MWB
high roof front-wheel drive

LOADING RAMP

Order no. RAM 303

Dimensions: **1150x2500 mm** (WxD)
Weight: **112,30 Kg**

Swivel loading ramp.

Load capacity: 1000 Kg (p.u.d.)



If the loading ramp is fitted, the MDL series modules for areas **3** and **5** cannot be installed. If you wish to install modules in areas **3** and **5** you need to ask your nearest STORE VAN distributor for a project feasibility study.

Technical
features,
see page 8

READY SOLUTIONS



Order no. MDL S13

Dimensions: **2032x365x1700 mm** (WxDxH). Weight: **60,15 Kg**

Module complete with:

- 4 trays with rubber and 20 adjustable dividers
- 1 fixing bar length 3000 mm



Order no. MDL S14

Dimensions: **1016x365x1700 mm** (WxDxH). Weight: **63,35 Kg**

Module complete with:

- 5 trays with rubber and 15 adjustable dividers
- 1 drawer
- 1 retractable shelf for tool cases complete with tool cases and boxes
- 1 fixing bar length 1500 mm



MODULES 1016 MM



Suitable to be installed in the zone: **2 3 5**

Order no. MDL 114

Dimensions: **1016x365x1700 mm** (WxDxH)

Weight: **62,90 Kg**

Module complete with:

- 4 trays with rubber and 12 adjustable dividers
- 2 drawers
- 1 shelf with door
- 1 hinged door



Suitable to be installed in the zone: **2 3 5**

Order no. MDL 115

Dimensions: **1016x365x1700 mm** (WxDxH)

Weight: **61,80 Kg**

Module complete with:

- 5 trays with rubber and 15 adjustable dividers
- 1 drawer
- 1 retractable shelf for tool cases complete with tool cases and boxes



Suitable to be installed in the zone: **2 3 5**

Order no. MDL 116

Dimensions: **1016x365x1700 mm** (WxDxH)

Weight: **46,70 Kg**

Module complete with:

- 6 trays with rubber and 18 adjustable dividers

*approximate measurement

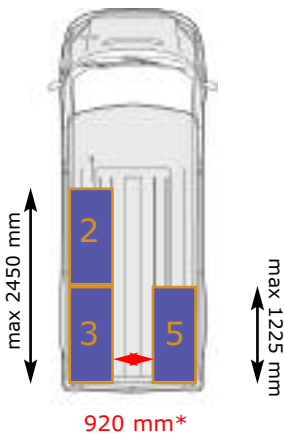

Suitable to be installed in the zone: **2**

Order no. MDL 117

Dimensions: **1016x365x1700 mm** (WxDxH)

Weight: **46,50 Kg**

Module complete with:

- 4 trays with rubber and 12 adjustable dividers
- 1 shelf with door
- 1 connection bar with fixing belts for tool cases



Suitable to be installed in the zone: **5**

Order no. MDL 118

Dimensions: **1016x365x1700 mm** (WxDxH)

Weight: **71,00 Kg**

Module complete with:

- 6 trays with rubber and 18 adjustable dividers
- 1 retractable vice workbench complete with steel vice with 100 mm jaws and 1/2" to 1 1/2" pipe clamp

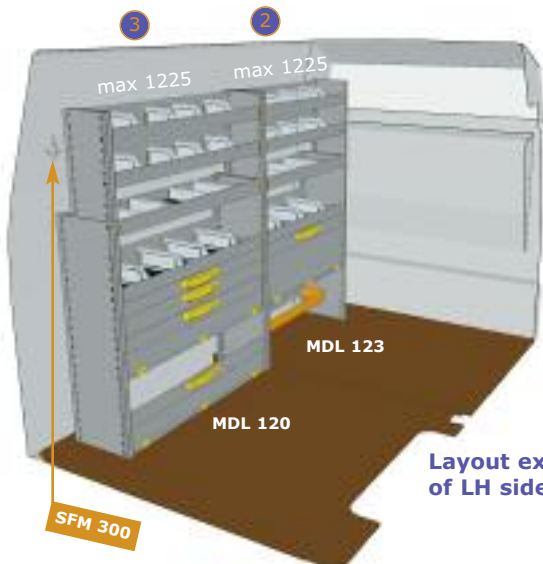

Layout example of LH side

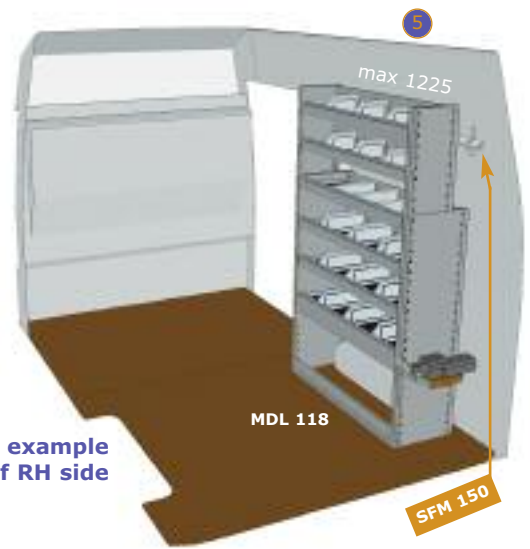

Layout example of RH side

8,85 m³
L2 H3 wheelbase 3300 mm



MODULES 1225 MM



Suitable to be installed in the zone: **2 3 5**

Order no. MDL 120

Dimensions: **1225x365x1700 mm** (WxDxH)

Weight: **72,95 Kg**

Module complete with:

- 4 trays with rubber and 16 adjustable dividers
- 2 drawers
- 1 shelf with door
- 1 hinged door



Suitable to be installed in the zone: **2 3 5**

Order no. MDL 121

Dimensions: **1225x365x1700 mm** (WxDxH)

Weight: **70,95 Kg**

Module complete with:

- 5 trays with rubber and 20 adjustable dividers
- 1 drawer
- 1 retractable shelf for tool cases complete with tool cases and boxes



Suitable to be installed in the zone: **2 3 5**

Order no. MDL 122

Dimensions: **1225x365x1700 mm** (WxDxH)

Weight: **55,00 Kg**

Module complete with:

- 6 trays with rubber and 24 adjustable dividers



Suitable to be installed in the zone: **2**

Order no. MDL 123

Dimensions: **1225x365x1700 mm** (WxDxH)

Weight: **54,65 Kg**

Module complete with:

- 4 trays with rubber and 16 adjustable dividers
- 1 shelf with door
- 1 connection bar with fixing belts for tool cases

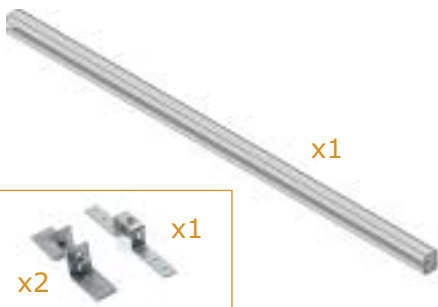

Order no. SFM 300

Fixing bar: **3000x30x35 mm** (WxDxH)

Weight: **2,60 Kg**

Fixing bar for modules, complete with brackets, bolts and screws.

The bar is necessary to fix the modules to the vehicle.



Order no. SFM 150

Fixing bar: **1500x30x35 mm** (WxDxH)

Weight: **1,55 Kg**

Fixing bar for modules, complete with brackets, bolts and screws.

The bar is necessary to fix the modules to the vehicle.

Technical features, see page 5

Accessories see page 9

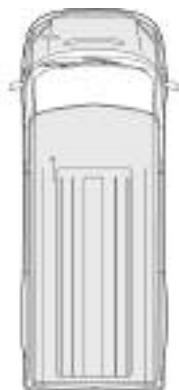
FLOORINGS AND LININGS

for **TRANSIT** with RH lateral sliding door and rear leaf doors, sheet metal side walls

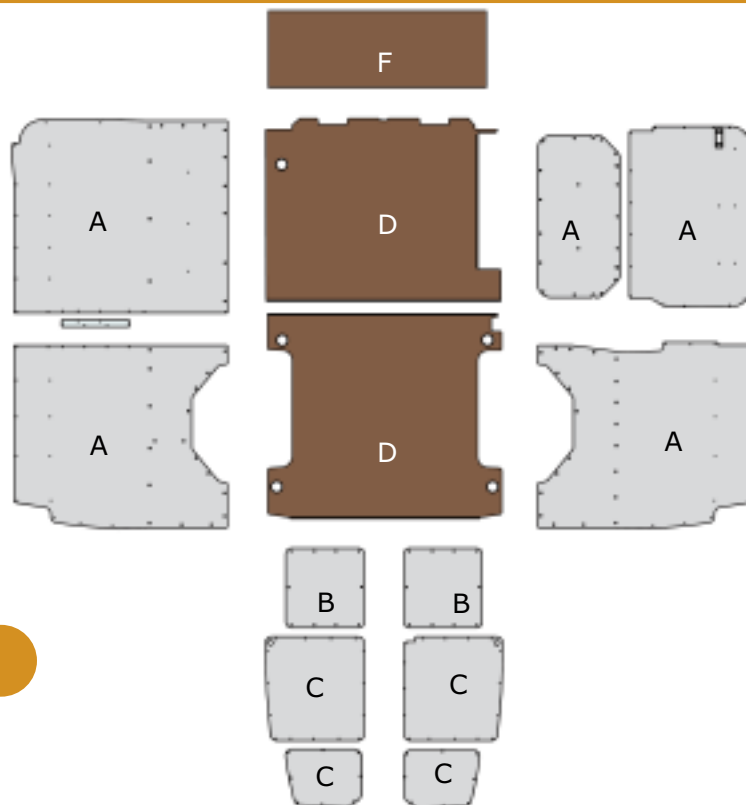
A + B Polypropylene linings
Order no. PAN 305

Weight: **16,30 Kg**

Polypropylene linings for:

- LH side wall
- RH side wall and sliding door
- lower section of rear leaf doors

Technical features, see page 5

C Polypropylene linings
Order no. PAR 305

Weight: **2,90 Kg**

Polypropylene linings for:

- upper section of rear leaf doors

D Flooring
Order no. PIL 306

Weight: **38,65 Kg**

12 mm thick wooden flooring phenolic coated and predrilling for lashing hook supports.

F Bulkhead
Order no. PIR 303

Weight: **7,35 Kg**

12 mm wooden phenolic coated bulkhead panel.

ROOF RACK

Order no. POT 305

Dimensions: **2750x1700 mm (WxD)**

Weight: **29,80 Kg**

Roof rack complete with:

- 3 aluminium crossmembers with fixing connectors and rubber profile
- 2 aluminium bars
- 2 2750 mm long aluminium side upstands
- 1 aluminium loading roller

Supplied with **stainless steel** screws for fixing.

Load capacity: 121 Kg (p.u.d.)

Technical features, see page 7

LADDER RACK

The ladder rack rail can be mounted on the right or on the left hand side of the vehicle

Order no. POS 305

Dimensions: **3240x1680 mm (WxD)**

Weight: **54,60 Kg**

Ladder rack complete with:

- 3 aluminium crossmembers with fixing connectors and rubber profile
- 1 2750 mm long aluminium side upstand
- 1 aluminium loading roller
- 1 ladder rack rail made from stainless steel and aluminium **ALADIN** series, length 3240 mm

Supplied with **stainless steel** screws for fixing.

Load capacity: 95 Kg (p.u.d.)

8,40 m³
L2 H3 wheelbase 3300 mm



TRANSIT VAN MWB
high roof rear-wheel drive

LOADING RAMP

Order no. RAM 303

Dimensions: **1150x2500 mm** (WxD)
Weight: **112,30 Kg**

Swivel loading ramp.

Load capacity: 1000 Kg (p.u.d.)



If the loading ramp is fitted, the MDL series modules for areas **3** and **5** cannot be installed. If you wish to install modules in areas **3** and **5** you need to ask your nearest STORE VAN distributor for a project feasibility study.

Technical
features,
see page 8

READY SOLUTIONS



Order no. MDL S13

Dimensions: **2032x365x1700 mm** (WxDxH). Weight: **60,15 Kg**

Module complete with:

- 4 trays with rubber and 20 adjustable dividers
- 1 fixing bar length 3000 mm



Order no. MDL S14

Dimensions: **1016x365x1700 mm** (WxDxH). Weight: **63,35 Kg**

Module complete with:

- 5 trays with rubber and 15 adjustable dividers
- 1 drawer
- 1 retractable shelf for tool cases complete with tool cases and boxes
- 1 fixing bar length 1500 mm



MODULES 1016 MM



Suitable to be installed in the zone: **2 3 5**

Order no. MDL 114

Dimensions: **1016x365x1700 mm** (WxDxH)

Weight: **62,90 Kg**

Module complete with:

- 4 trays with rubber and 12 adjustable dividers
- 2 drawers
- 1 shelf with door
- 1 hinged door

Suitable to be installed in the zone: **2 3 5**

Order no. MDL 115

Dimensions: **1016x365x1700 mm** (WxDxH)

Weight: **61,80 Kg**

Module complete with:

- 5 trays with rubber and 15 adjustable dividers
- 1 drawer
- 1 retractable shelf for tool cases complete with tool cases and boxes

Suitable to be installed in the zone: **2 3 5**

Order no. MDL 116

Dimensions: **1016x365x1700 mm** (WxDxH)

Weight: **46,70 Kg**

Module complete with:

- 6 trays with rubber and 18 adjustable dividers

*approximate measurement

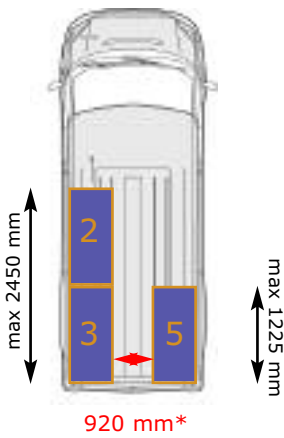

Suitable to be installed in the zone: **2**

Order no. MDL 117

Dimensions: **1016x365x1700 mm** (WxDxH)

Weight: **46,50 Kg**

Module complete with:

- 4 trays with rubber and 12 adjustable dividers
- 1 shelf with door
- 1 connection bar with fixing belts for tool cases

Suitable to be installed in the zone: **5**

Order no. MDL 118

Dimensions: **1016x365x1700 mm** (WxDxH)

Weight: **71,00 Kg**

Module complete with:

- 6 trays with rubber and 18 adjustable dividers
- 1 retractable vice workbench complete with steel vice with 100 mm jaws and 1/2" to 1 1/2" pipe clamp

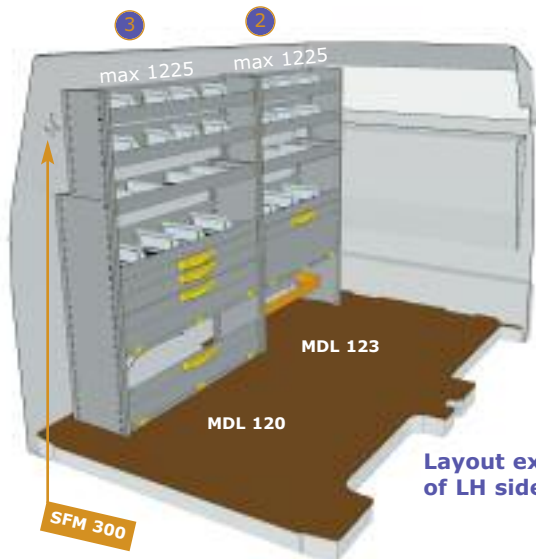

Layout example of LH side

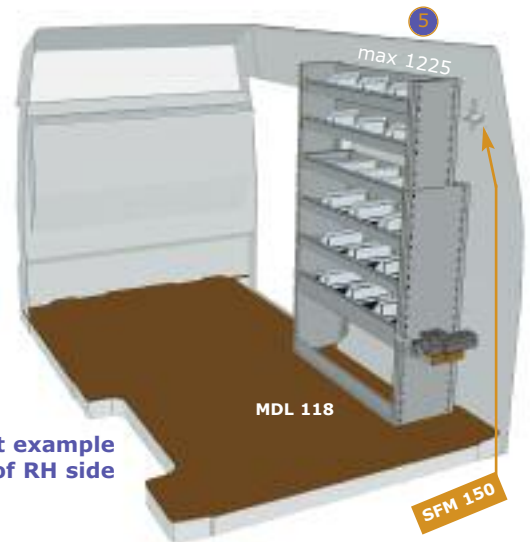

Layout example of RH side

8,40 m³
L2 H3 wheelbase 3300 mm



TRANSIT VAN MWB
high roof rear-wheel drive

MODULES 1225 MM



Suitable to be installed in the zone: **2 3 5**

Order no. MDL 120

Dimensions: **1225x365x1700 mm** (WxDxH)
Weight: **72,95 Kg**

Module complete with:

- 4 trays with rubber and 16 adjustable dividers
- 2 drawers
- 1 shelf with door
- 1 hinged pivoting door



Suitable to be installed in the zone: **2 3 5**

Order no. MDL 121

Dimensions: **1225x365x1700 mm** (WxDxH)
Weight: **70,95 Kg**

Module complete with:

- 5 trays with rubber and 20 adjustable dividers
- 1 drawer
- 1 retractable shelf for tool cases complete with tool cases and boxes



Suitable to be installed in the zone: **2 3 5**

Order no. MDL 122

Dimensions: **1225x365x1700 mm** (WxDxH)
Weight: **55,00 Kg**

Module complete with:

- 6 trays with rubber and 24 adjustable dividers



Suitable to be installed in the zone: **2**

Order no. MDL 123

Dimensions: **1225x365x1700 mm** (WxDxH)
Weight: **54,65 Kg**

Module complete with:

- 4 trays with rubber and 16 adjustable dividers
- 1 shelf with door
- 1 connection bar with fixing belts for tool cases

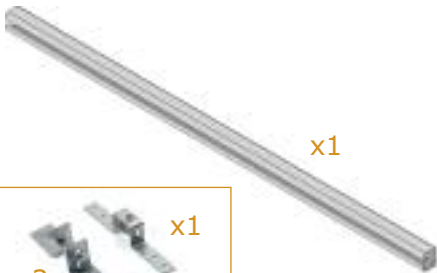

Order no. SFM 300

Fixing bar: **3000x30x35 mm** (WxDxH)
Weight: **2,60 Kg**

Fixing bar for modules, complete with brackets, bolts and screws.

The bar is necessary to fix the modules to the vehicle.

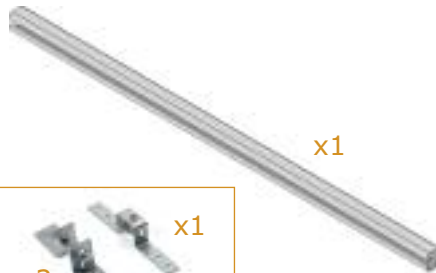

Order no. SFM 150

Fixing bar: **1500x30x35 mm** (WxDxH)
Weight: **1,55 Kg**

Fixing bar for modules, complete with brackets, bolts and screws.

The bar is necessary to fix the modules to the vehicle.

Technical features, see page 5

Accessories see page 9



FLOORINGS AND LININGS



for **TRANSIT** with RH lateral sliding door and rear leaf doors, sheet metal side walls

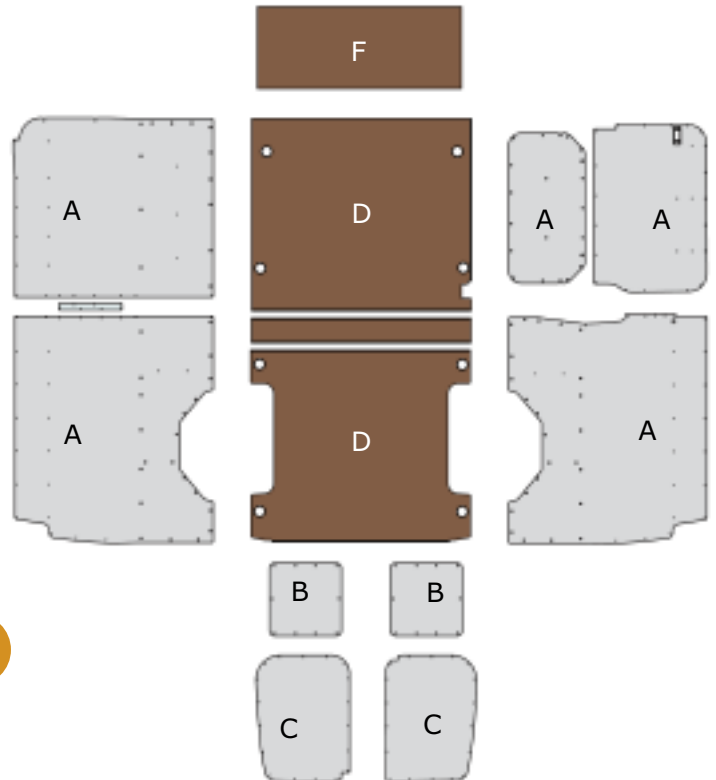

A + B Polypropylene linings Order no. PAN 306

Weight: **18,95 Kg**

Polypropylene linings for:

- LH side wall
- RH side wall and sliding door
- lower section of rear leaf doors

Technical features,
see page 5

C Polypropylene linings Order no. PAR 304

Weight: **2,70 Kg**

Polypropylene linings for:

- upper section of rear leaf doors

D Flooring Order no. PIL 307

Weight: **46,60 Kg**

12 mm thick wooden flooring phenolic coated and predrilling for lashing hook supports.

F Bulkhead Order no. PIR 302

Weight: **8,40 Kg**

12 mm wooden phenolic coated bulkhead panel.

ROOF RACK



Order no. POT 306

Dimensions: **3400x1700 mm** (WxD)

Weight: **33,70 Kg**

Roof rack complete with:

- 3 aluminium crossmembers with fixing connectors and rubber profile
- 2 aluminium bars
- 2 3400 mm long aluminium side upstands
- 1 aluminium loading roller

Supplied with **stainless steel** screws for fixing.

Load capacity: 117 Kg (p.u.d.)

Technical features,
see page 7

LADDER RACK

The ladder rack rail can be mounted on the right or on the left hand side of the vehicle

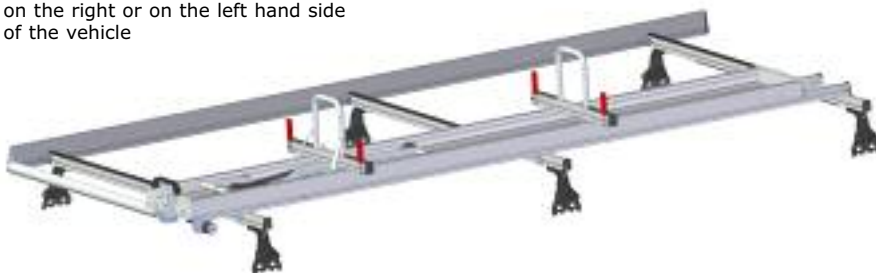

Order no. POS 306

Dimensions: **3400x1680 mm** (WxD)

Weight: **56,60 Kg**

Ladder rack complete with:

- 3 aluminium crossmembers with fixing connectors and rubber profile
- 1 3400 mm long aluminium side upstand
- 1 aluminium loading roller
- 1 ladder rack rail made from stainless steel and aluminium **ALADIN** series, length 3240 mm

Supplied with **stainless steel** screws for fixing.

Load capacity: 93 Kg (p.u.d.)

8,97 m³
L3 H2 wheelbase 3750 mm

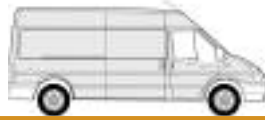

TRANSIT VAN LWB
medium roof front-wheel drive

LOADING RAMP

Order no. RAM 302

Dimensions: **1150x2500 mm** (WxD)
Weight: **111,50 Kg**

Swivel loading ramp.

Load capacity: 1000 Kg (p.u.d.)

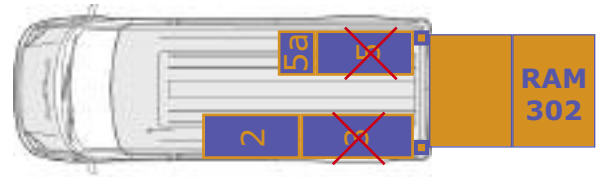

If the loading ramp is fitted, the MDL series modules for areas **3** and **5** cannot be installed.
If you wish to install modules in areas **3** and **5** you need to ask your nearest STORE VAN distributor for a project feasibility study.

Technical
features,
see page 8

READY SOLUTIONS



Order no. MDL S15

Dimensions: **2749x365x1500 mm** (WxDxH). Weight: **96,50 Kg**

Set of 2 modules complete with:

- 7 trays with rubber and 29 adjustable dividers
- 1 shelf with door
- 1 connection bar with fixing belts for tool cases
- 1 fixing bar length 3500 mm



Order no. MDL S16

Dimensions: **1733x365x1500 mm** (WxDxH). Weight: **54,75 Kg**

Module complete with:

- 4 trays with rubber and 20 adjustable dividers
- 1 fixing bar length 2000 mm



MODULES 1524 MM



Suitable to be installed in the zone: **3**

Order no. MDL 125

Dimensions: **1524x365x1700 mm** (WxDxH)
Weight: **65,35 Kg**

Module complete with:
6 trays with rubber and 30 adjustable dividers

MODULES 1225 MM



Suitable to be installed in the zone: **2 3 5**

Order no. MDL 120

Dimensions: **1225x365x1700 mm** (WxDxH)
Weight: **72,95 Kg**

Module complete with:
4 trays with rubber and 16 adjustable dividers
2 drawers
1 shelf with door
1 hinged door



Suitable to be installed in the zone: **2 3 5**

Order no. MDL 121

Dimensions: **1225x365x1700 mm** (WxDxH)
Weight: **70,95 Kg**

Module complete with:
5 trays with rubber and 20 adjustable dividers
1 drawer
1 retractable shelf for tool cases complete with tool cases and boxes

Technical features, see page 5
Accessories see page 9

*approximate measurement

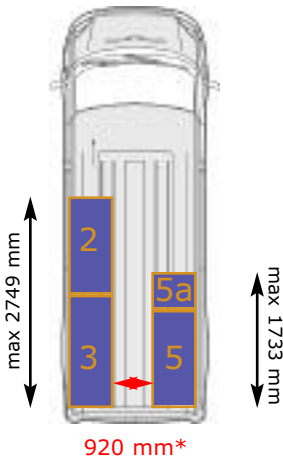

Suitable to be installed in the zone: **2 3 5**

Order no. MDL 122

Dimensions: **1225x365x1700 mm** (WxDxH)
Weight: **55,00 Kg**

Module complete with:
6 trays with rubber and 24 adjustable dividers



Suitable to be installed in the zone: **2**

Order no. MDL 123

Dimensions: **1225x365x1700 mm** (WxDxH)
Weight: **54,65 Kg**

Module complete with:
4 trays with rubber and 16 adjustable dividers
1 shelf with door
1 connection bar with fixing belts for tool cases

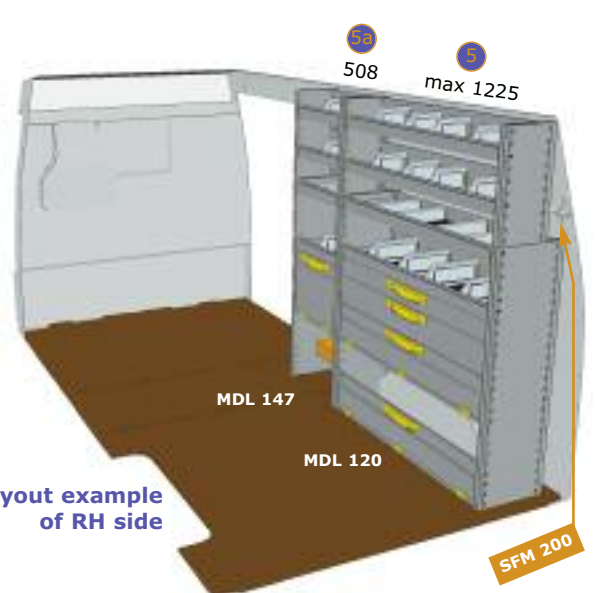
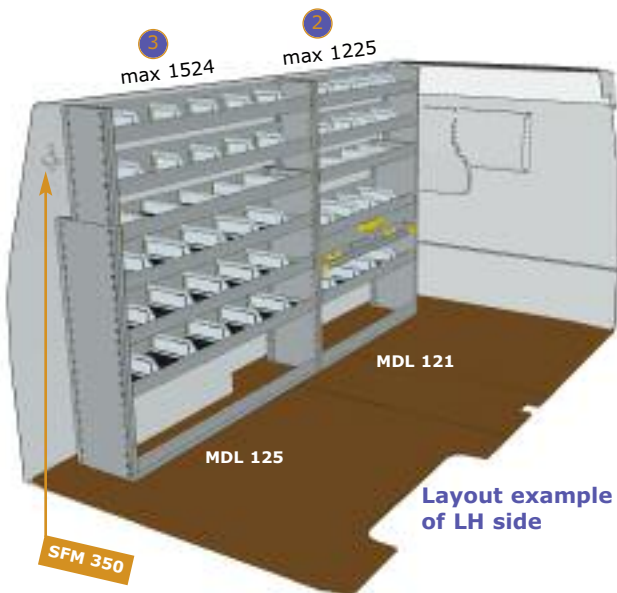



MODULES 1016 MM

MODULES 508 mm



Suitable to be installed in the zone: **2 3 5**

Suitable to be installed in the zone: **2 3 5**

Suitable to be installed in the zone: **5a**

Order no. MDL 114

Dimensions: **1016x365x1700 mm** (WxDxH)
Weight: **62,90 Kg**

Module complete with:

- 4 trays with rubber and 12 adjustable dividers
- 2 drawers
- 1 shelf with door
- 1 hinged door

Order no. MDL 115

Dimensions: **1016x365x1700 mm** (WxDxH)
Weight: **61,80 Kg**

Module complete with:

- 5 trays with rubber and 15 adjustable dividers
- 1 drawer
- 1 retractable shelf for tool cases complete with tool cases and boxes

Order no. MDL 146

Dimensions: **508x365x1700 mm** (WxDxH)
Weight: **30,80 Kg**

Module complete with:

- 6 trays with rubber and 6 adjustable dividers



Suitable to be installed in the zone: **2 3 5**

Suitable to be installed in the zone: **2**

Suitable to be installed in the zone: **5a**

Order no. MDL 116

Dimensions: **1016x365x1700 mm** (WxDxH)
Weight: **46,70 Kg**

Module complete with:

- 6 trays with rubber and 18 adjustable dividers

Order no. MDL 117

Dimensions: **1016x365x1700 mm** (WxDxH)
Weight: **46,50 Kg**

Module complete with:

- 4 trays with rubber and 12 adjustable dividers
- 1 shelf with door
- 1 connection bar with fixing belts for tool cases

Order no. MDL 147

Dimensions: **508x365x1700 mm** (WxDxH)
Weight: **32,70 Kg**

Module complete with:

- 4 trays with rubber and 4 adjustable dividers
- 1 shelf with door
- 1 connection bar with fixing belts for tool cases

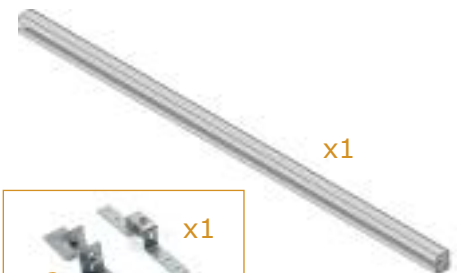
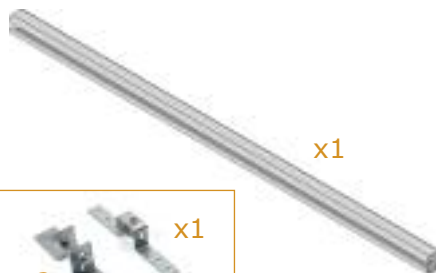

Suitable to be installed in the zone: **5**

Order no. MDL 118

Dimensions: **1016x365x1700 mm** (WxDxH)
Weight: **71,00 Kg**

Module complete with:

- 6 trays with rubber and 18 adjustable dividers
- 1 retractable vice workbench complete with steel vice with 100 mm jaws and 1/2" to 1 1/2" pipe clamp

Order no. SFM 350

Fixing bar: **3500x30x35 mm** (WxDxH)
Weight: **2,93 Kg**

Fixing bar for modules, complete with brackets, bolts and screws.

The bar is necessary to fix the modules to the vehicle.

Order no. SFM 200

Fixing bar: **2000x30x35 mm** (WxDxH)
Weight: **1,88 Kg**

Fixing bar for modules, complete with brackets, bolts and screws.

The bar is necessary to fix the modules to the vehicle.

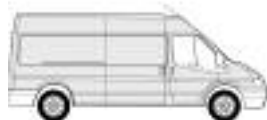

FLOORINGS AND LININGS



for **TRANSIT** with RH lateral sliding door and rear leaf doors, sheet metal side walls

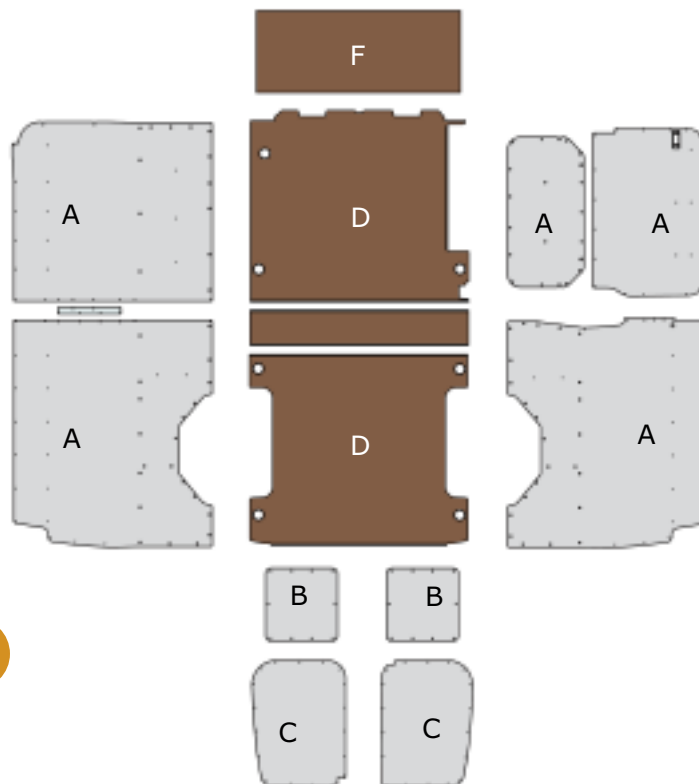

A + B Polypropylene linings Order no. PAN 306

Weight: **18,95 Kg**

Polypropylene linings for:

- LH side wall
- RH side wall and sliding door
- lower section of rear leaf doors

Technical features,
see page 5

C Polypropylene linings Order no. PAR 304

Weight: **2,70 Kg**

Polypropylene linings for:

- upper section of rear leaf doors

D Flooring Order no. PIL 308

Weight: **45,80 Kg**

12 mm thick wooden flooring phenolic coated and predrilling for lashing hook supports.

F Bulkhead Order no. PIR 303

Weight: **7,35 Kg**

12 mm wooden phenolic coated bulkhead panel.

ROOF RACK



Order no. POT 306

Dimensions: **3400x1700 mm** (WxD)

Weight: **33,70 Kg**

Roof rack complete with:

- 3 aluminium crossmembers with fixing connectors and rubber profile
- 2 aluminium bars
- 2 3400 mm long aluminium side upstands
- 1 aluminium loading roller

Supplied with **stainless steel** screws for fixing.

Load capacity: 117 Kg (p.u.d.)

Technical features,
see page 7

LADDER RACK

The ladder rack rail can be mounted on the right or on the left hand side of the vehicle

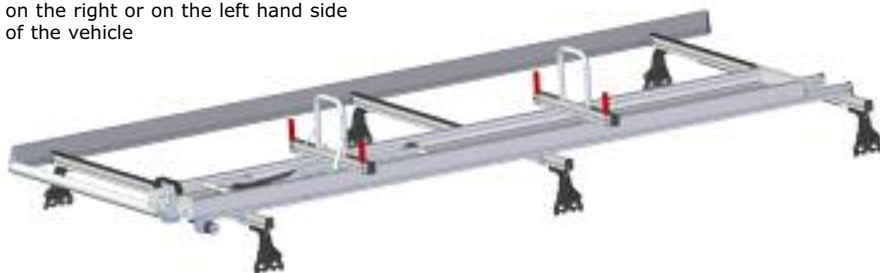

Order no. POS 306

Dimensions: **3400x1680 mm** (WxD)

Weight: **56,60 Kg**

Ladder rack complete with:

- 3 aluminium crossmembers with fixing connectors and rubber profile
- 1 3400 mm long aluminium side upstand
- 1 aluminium loading roller
- 1 ladder rack rail made from stainless steel and aluminium **ALADIN** series, length 3240 mm

Supplied with **stainless steel** screws for fixing.

Load capacity: 93 Kg (p.u.d.)

8,45 m³
L3 H2 wheelbase 3750 mm

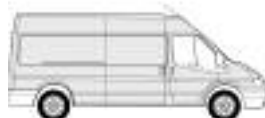

TRANSIT VAN LWB
medium roof rear-wheel drive

LOADING RAMP

Order no. RAM 302

Dimensions: **1150x2500 mm** (WxD)
Weight: **111,50 Kg**

Swivel loading ramp.

Load capacity: 1000 Kg (p.u.d.)



If the loading ramp is installed the MDL series modules for areas **3** and **5** cannot be installed.
If you wish to install modules in areas **3** and **5** you need to ask your nearest STORE VAN distributor for a project feasibility study.

Technical
features,
see page 8

READY SOLUTIONS



Order no. MDL S15

Dimensions: **2749x365x1500 mm** (WxDxH). Weight: **96,50 Kg**

Set of 2 modules complete with:

- 7 trays with rubber and 29 adjustable dividers
- 1 shelf with door
- 1 connection bar with fixing belts for tool cases
- 1 fixing bar length 3500 mm



Order no. MDL S16

Dimensions: **1733x365x1500 mm** (WxDxH). Weight: **54,75 Kg**

Module complete with:

- 4 trays with rubber and 20 adjustable dividers
- 1 fixing bar length 2000 mm



MODULES 1524 MM



Suitable to be installed in the zone: **3**

Order no. MDL 225

Dimensions: **1524x365x1500 mm** (WxDxH)
Weight: **57,35 Kg**

Module complete with:

- 5 trays with rubber and 25 adjustable dividers

Technical features, see page 5

Accessories see page 9

*approximate measurement

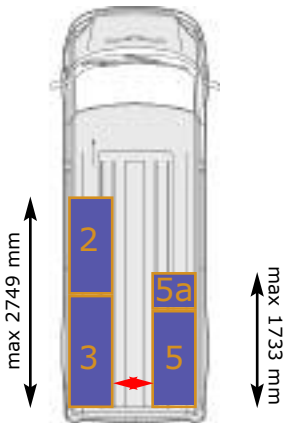

920 mm*

MODULES 1225 MM

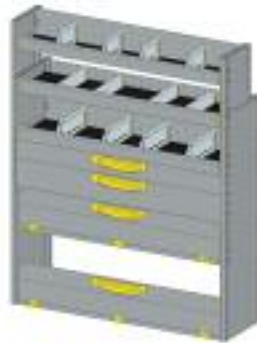

Suitable to be installed in the zone: **2 3 5**

Order no. MDL 220

Dimensions: **1225x365x1500 mm** (WxDxH)
Weight: **66,10 Kg**

Module complete with:

- 3 trays with rubber and 12 adjustable dividers
- 2 drawers
- 1 shelf with door
- 1 hinged door



Suitable to be installed in the zone: **2 3 5**

Order no. MDL 221

Dimensions: **1225x365x1500 mm** (WxDxH)
Weight: **64,10 Kg**

Module complete with:

- 4 trays with rubber and 16 adjustable dividers
- 1 drawer
- 1 retractable shelf for tool cases complete with tool cases and boxes



Suitable to be installed in the zone: **2 3 5**

Order no. MDL 222

Dimensions: **1225x365x1500 mm** (WxDxH)
Weight: **48,15 Kg**

Module complete with:

- 5 trays with rubber and 20 adjustable dividers



Suitable to be installed in the zone: **2**

Order no. MDL 223

Dimensions: **1225x365x1500 mm** (WxDxH)
Weight: **47,80 Kg**

Module complete with:

- 3 trays with rubber and 12 adjustable dividers
- 1 shelf with horizontally pivoting door
- 1 connection bar with fixing belts for tool cases

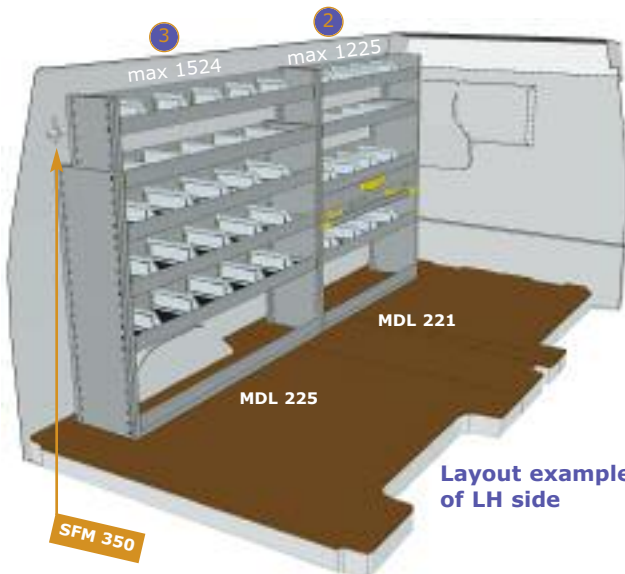

Layout example of LH side

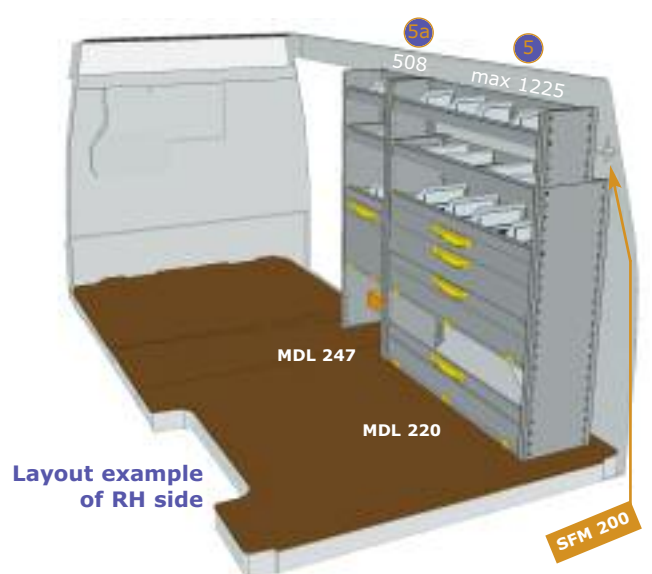

Layout example of RH side



MODULES 1016 MM

MODULES 508 mm

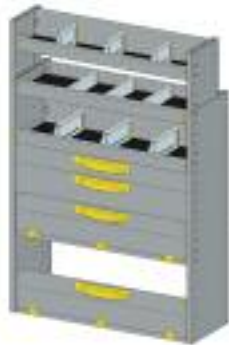

Suitable to be installed in the zone: **2 3 5**

Order no. MDL 214

Dimensions: **1016x365x1500 mm** (WxDxH)
Weight: **57,10 Kg**

Module complete with:

- 3 trays with rubber and 9 adjustable dividers
- 2 drawers
- 1 shelf with door
- 1 hinged door

Suitable to be installed in the zone: **2 3 5**

Order no. MDL 215

Dimensions: **1016x365x1500 mm** (WxDxH)
Weight: **56,00 Kg**

Module complete with:

- 4 trays with rubber and 12 adjustable dividers
- 1 drawer
- 1 retractable shelf for tool cases complete with tool cases and boxes

Suitable to be installed in the zone: **5a**

Order no. MDL 246

Dimensions: **508x365x1500 mm** (WxDxH)
Weight: **27,30 Kg**

Module complete with:

- 5 trays with rubber and 5 adjustable dividers



Suitable to be installed in the zone: **2 3 5**

Order no. MDL 216

Dimensions: **1016x365x1500 mm** (WxDxH)
Weight: **40,90 Kg**

Module complete with:

- 5 trays with rubber and 15 adjustable dividers

Suitable to be installed in the zone: **2**

Order no. MDL 217

Dimensions: **1016x365x1500 mm** (WxDxH)
Weight: **40,70 Kg**

Module complete with:

- 3 trays with rubber and 9 adjustable dividers
- 1 shelf with door
- 1 connection bar with fixing belts for tool cases

Suitable to be installed in the zone: **5a**

Order no. MDL 247

Dimensions: **508x365x1500 mm** (WxDxH)
Weight: **29,20 Kg**

Module complete with:

- 3 trays with rubber and 3 adjustable dividers
- 1 shelf with door
- 1 connection bar with fixing belts for tool cases

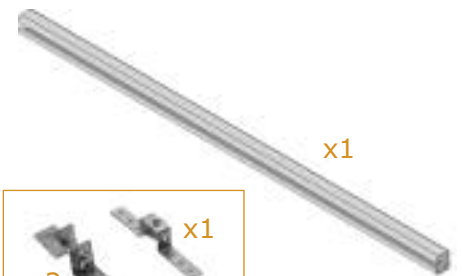
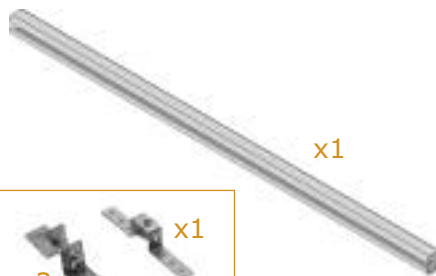

Suitable to be installed in the zone: **5**

Order no. MDL 218

Dimensions: **1016x365x1500 mm** (WxDxH)
Weight: **65,20 Kg**

Module complete with:

- 5 trays with rubber and 15 adjustable dividers
- 1 retractable vice workbench complete with steel vice with 100 mm jaws and 1/2" to 1 1/2" pipe clamp

Order no. SFM 350

Fixing bar: **3500x30x35 mm** (WxDxH)
Weight: **2,93 Kg**

Fixing bar for modules, complete with brackets, bolts and screws.

The bar is necessary to fix the modules to the vehicle.

Order no. SFM 200

Fixing bar: **2000x30x35 mm** (WxDxH)
Weight: **1,88 Kg**

Fixing bar for modules, complete with brackets, bolts and screws.

The bar is necessary to fix the modules to the vehicle.



FLOORINGS AND LININGS



for **TRANSIT** with RH lateral sliding door and rear leaf doors, sheet metal side walls

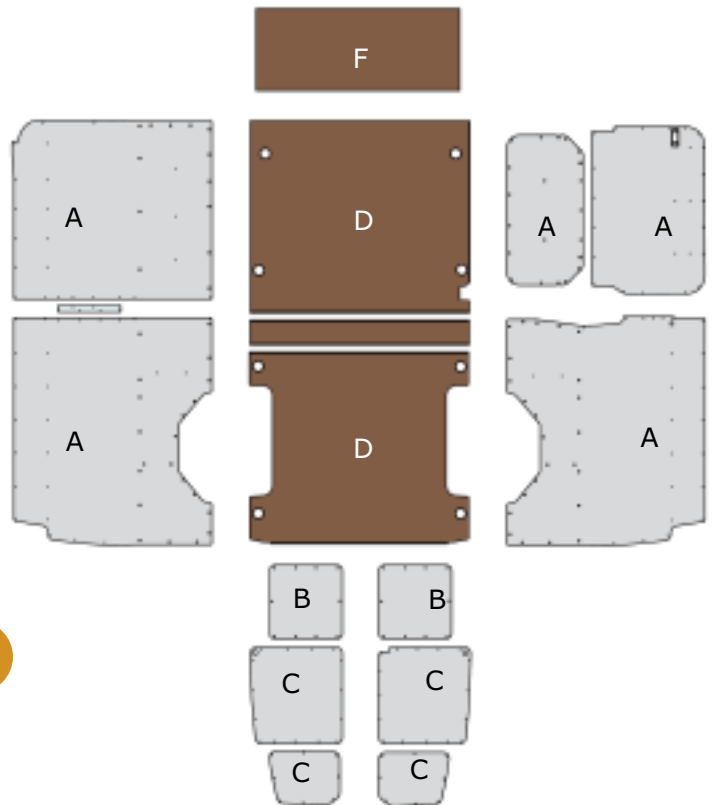

A + B Polypropylene linings Order no. PAN 306

Weight: **18,95 Kg**

Polypropylene linings for:

- LH side wall
- RH side wall and sliding door
- lower section of rear leaf doors

Technical features,
see page 5

C Polypropylene linings Order no. PAR 305

Weight: **2,90 Kg**

Polypropylene linings for:

- upper section of rear leaf doors

D Flooring Order no. PIL 307

Weight: **46,60 Kg**

12 mm thick wooden flooring phenolic coated and predrilling for lashing hook supports.

F Bulkhead Order no. PIR 302

Weight: **8,40 Kg**

12 mm wooden phenolic coated bulkhead panel.

ROOF RACK



Order no. POT 307

Dimensions: **3000x1700 mm** (WxD)

Weight: **32,50 Kg**

Roof rack complete with:

- 3 aluminium crossmembers with fixing connectors and rubber profile
- 2 aluminium bars
- 2 3000 mm long aluminium side upstands
- 1 aluminium loading roller

Supplied with **stainless steel** screws for fixing.

Load capacity: 118 Kg (p.u.d.)

Technical features,
see page 7

LADDER RACK

The ladder rack slide can be mounted on the right or on the left hand side of the vehicle

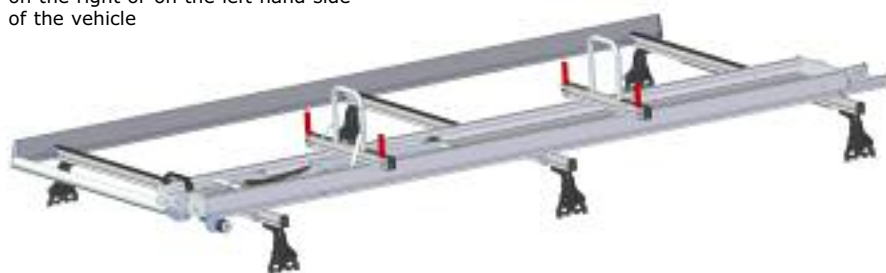

Order no. POS 307

Dimensions: **3240x1680 mm** (WxD)

Weight: **56,00 Kg**

Ladder rack complete with:

- 3 aluminium crossmembers with fixing connectors and rubber profile
- 1 3000 mm long aluminium side upstand
- 1 aluminium loading roller
- 1 ladder rack rail made from stainless steel and aluminium **ALADIN** series, length 3240 mm

Supplied with **stainless steel** screws for fixing.

Load capacity: 94 Kg (p.u.d.)

10,20 m³
L3 H3 wheelbase 3750 mm



TRANSIT VAN LWB
high roof front-wheel drive

LOADING RAMP

Order no. RAM 303

Dimensions: **1150x2500 mm** (WxD)
Weight: **112,30 Kg**

Swivel loading ramp.

Load capacity: 1000 Kg (p.u.d.)



If the loading ramp is fitted, the MDL series modules for areas **3** and **5** cannot be installed.
If you wish to install modules in areas **3** and **5** you need to ask your nearest STORE VAN distributor for a project feasibility study.

Technical
features,
see page 8

READY SOLUTIONS



Order no. MDL S17

Dimensions: **2749x365x1700 mm** (WxDxH). Weight: **103,50 Kg**

Set of 2 modules complete with:

- 8 trays with rubber and 32 adjustable dividers
- 1 shelf with door
- 1 connection bar with fixing belts for tool cases
- 1 fixing bar length 3500 mm



Order no. MDL S18

Dimensions: **1733x365x1700 mm** (WxDxH). Weight: **55,95 Kg**

Module complete with:

- 4 trays with rubber and 20 adjustable dividers
- 1 fixing bar length 2000 mm



MODULES 1524 MM



Suitable to be installed in the zone: **3**

Order no. MDL 125

Dimensions: **1524x365x1700 mm** (WxDxH)
Weight: **65,35 Kg**

Module complete with:

- 6 trays with rubber and 30 adjustable dividers

MODULES 1225 MM



Suitable to be installed in the zone: **2 3 5**

Order no. MDL 120

Dimensions: **1225x365x1700 mm** (WxDxH)
Weight: **72,95 Kg**

Module complete with:

- 4 trays with rubber and 16 adjustable dividers
- 2 drawers
- 1 shelf with door
- 1 hinged door



Suitable to be installed in the zone: **2 3 5**

Order no. MDL 121

Dimensions: **1225x365x1700 mm** (WxDxH)
Weight: **70,95 Kg**

Module complete with:

- 5 trays with rubber and 20 adjustable dividers
- 1 drawer
- 1 retractable shelf for tool cases complete with tool cases and boxes

Technical features, see page 5
Accessories see page 9

*approximate measurement

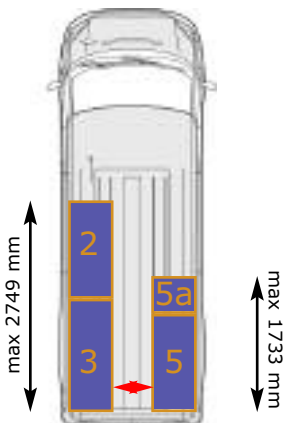

Suitable to be installed in the zone: **2 3 5**

Order no. MDL 122

Dimensions: **1225x365x1700 mm** (WxDxH)
Weight: **55,00 Kg**

Module complete with:

- 6 trays with rubber and 24 adjustable dividers



Suitable to be installed in the zone: **2**

Order no. MDL 123

Dimensions: **1225x365x1700 mm** (WxDxH)
Weight: **54,65 Kg**

Module complete with:

- 4 trays with rubber and 16 adjustable dividers
- 1 shelf with door
- 1 connection bar with fixing belts for tool cases

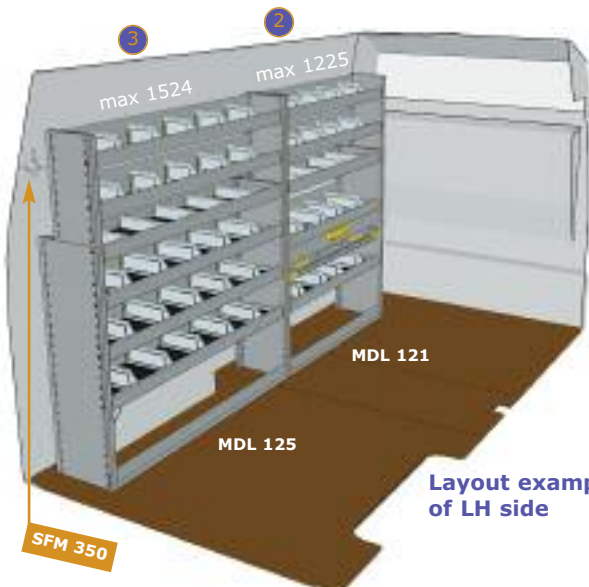

Layout example of LH side

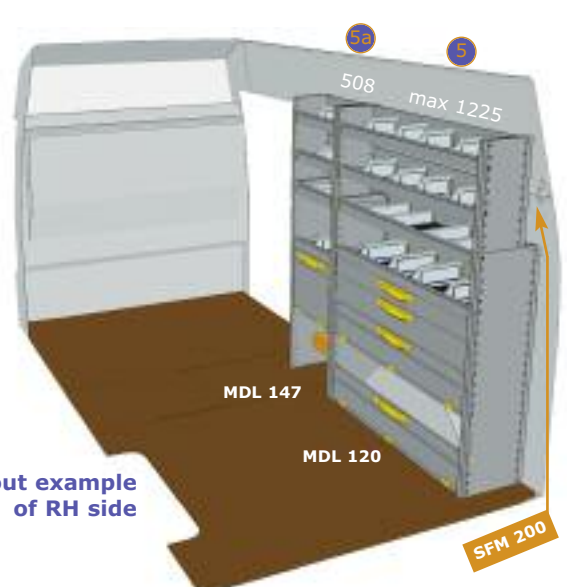

Layout example of RH side



MODULES 1016 MM

MODULES 508 mm



Suitable to be installed in the zone: **2 3 5**

Order no. MDL 114

Dimensions: **1016x365x1700 mm** (WxDxH)
Weight: **62,90 Kg**
Module complete with:
4 trays with rubber and 12 adjustable dividers
2 drawers
1 shelf with door
1 hinged door

Suitable to be installed in the zone: **2 3 5**

Order no. MDL 115

Dimensions: **1016x365x1700 mm** (WxDxH)
Weight: **61,80 Kg**
Module complete with:
5 trays with rubber and 15 adjustable dividers
1 drawer
1 retractable shelf for tool cases complete with tool cases and boxes

Suitable to be installed in the zone: **5a**

Order no. MDL 146

Dimensions: **508x365x1700 mm** (WxDxH)
Weight: **30,80 Kg**
Module complete with:
6 trays with rubber and 6 adjustable dividers



Suitable to be installed in the zone: **2 3 5**

Order no. MDL 116

Dimensions: **1016x365x1700 mm** (WxDxH)
Weight: **46,70 Kg**
Module complete with:
6 trays with rubber and 18 adjustable dividers

Suitable to be installed in the zone: **2**

Order no. MDL 117

Dimensions: **1016x365x1700 mm** (WxDxH)
Weight: **46,50 Kg**
Module complete with:
4 trays with rubber and 12 adjustable dividers
1 shelf with door
1 connection bar with fixing belts for tool cases

Suitable to be installed in the zone: **5a**

Order no. MDL 147

Dimensions: **508x365x1700 mm** (WxDxH)
Weight: **32,70 Kg**
Module complete with:
4 trays with rubber and 4 adjustable dividers
1 shelf with door
1 connection bar with fixing belts for tool cases

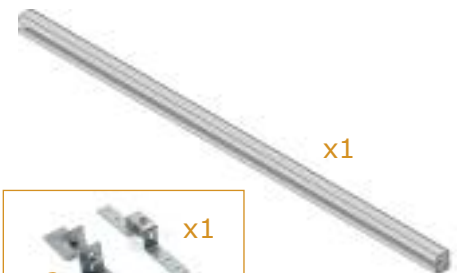
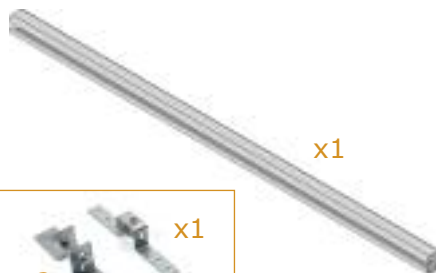

Suitable to be installed in the zone: **5**

Order no. MDL 118

Dimensions: **1016x365x1700 mm** (WxDxH)
Weight: **71,00 Kg**
Module complete with:
6 trays with rubber and 18 adjustable dividers
1 retractable vice workbench complete with steel vice with 100 mm jaws and 1/2" to 1 1/2" pipe clamp

Order no. SFM 350

Fixing bar: **3500x30x35 mm** (WxDxH)
Weight: **2,93 Kg**
Fixing bar for modules, complete with brackets, bolts and screws.
The bar is necessary to fix the modules to the vehicle.

Order no. SFM 200

Fixing bar: **2000x30x35 mm** (WxDxH)
Weight: **1,88 Kg**
Fixing bar for modules, complete with brackets, bolts and screws.
The bar is necessary to fix the modules to the vehicle.



FLOORINGS AND LININGS



for **TRANSIT** with RH lateral sliding door and rear leaf doors, sheet metal side walls

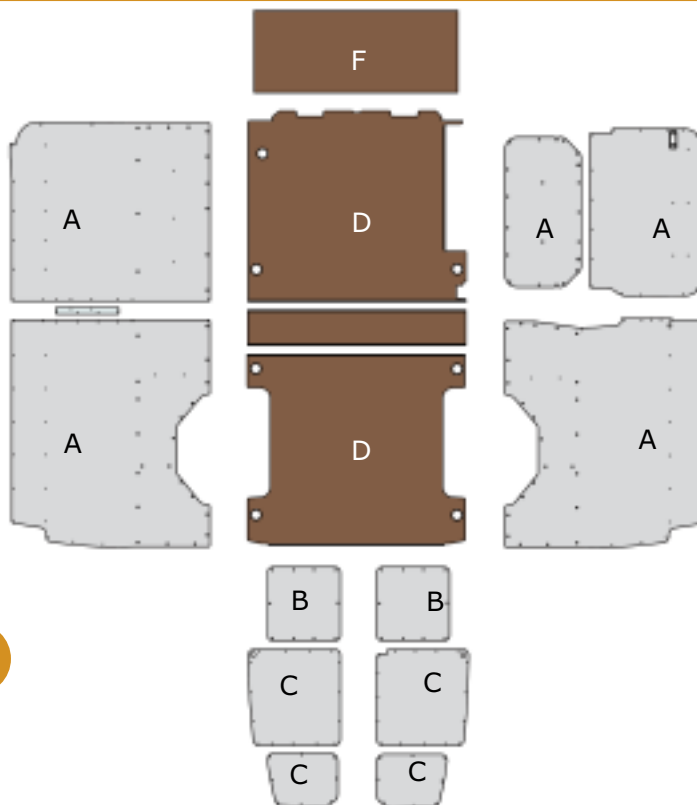

A + B Polypropylene linings Order no. PAN 306

Weight: **18,95 Kg**

Polypropylene linings for:

- LH side wall
- RH side wall and sliding door
- lower section of rear leaf doors

Technical features,
see page 5

C Polypropylene linings Order no. PAR 305

Weight: **2,90 Kg**

Polypropylene linings for:

- upper section of rear leaf doors

D Flooring Order no. PIL 308

Weight: **45,80 Kg**

12 mm thick wooden flooring phenolic coated and predrilling for lashing hook supports.

F Bulkhead Order no. PIR 303

Weight: **7,35 Kg**

12 mm wooden phenolic coated bulkhead panel.

ROOF RACK



Order no. POT 307

Dimensions: **3000x1700 mm** (WxD)

Weight: **32,50 Kg**

Roof rack complete with:

- 3 aluminium crossmembers with fixing connectors and rubber profile
- 2 aluminium bars
- 2 3000 mm long aluminium side upstands
- 1 aluminium loading roller

Supplied with **stainless steel** screws for fixing.

Load capacity: 118 Kg (p.u.d.)

Technical features,
see page 7

LADDER RACK

The ladder rack rail can be mounted on the right or on the left hand side of the vehicle

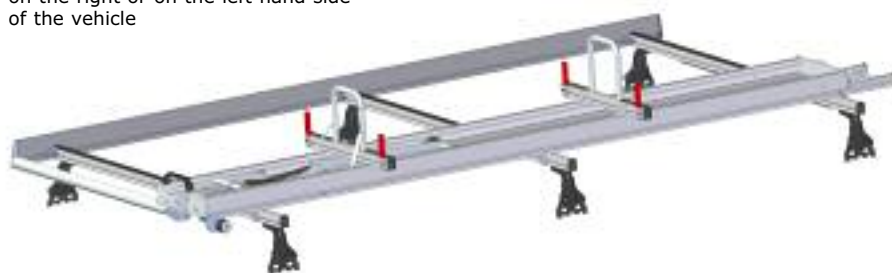

Order no. POS 307

Dimensions: **3240x1680 mm** (WxD)

Weight: **56,00 Kg**

Ladder rack complete with:

- 3 aluminium crossmembers with fixing connectors and rubber profile
- 1 3000 mm long aluminium side upstand
- 1 aluminium loading roller
- 1 ladder rack rail made from stainless steel and aluminium **ALADIN** series, length 3240 mm

Supplied with **stainless steel** screws for fixing.

Load capacity: 94 Kg (p.u.d.)

9,69 m³
L3 H3 wheelbase 3750 mm



TRANSIT VAN LWB
high roof rear-wheel drive

LOADING RAMP

Order no. RAM 303

Dimensions: **1150x2500 mm** (WxD)
Weight: **112,30 Kg**

Swivel loading ramp.

Load capacity: **1000 Kg** (p.u.d.)



If the loading ramp is fitted, the MDL series modules for areas **3** and **5** cannot be installed.
If you wish to install modules in areas **3** and **5** you need to ask your nearest STORE VAN distributor for a project feasibility study.

Technical
features,
see page 8

READY SOLUTIONS



Order no. MDL S17

Dimensions: **2749x365x1700 mm** (WxDxH). Weight: **103,50 Kg**

Set of 2 modules complete with:

- 8 trays with rubber and 32 adjustable dividers
- 1 shelf with door
- 1 connection bar with fixing belts for tool cases
- 1 fixing bar length 3500 mm



Order no. MDL S18

Dimensions: **1733x365x1700 mm** (WxDxH). Weight: **55,95 Kg**

Module complete with:

- 4 trays with rubber and 20 adjustable dividers
- 1 fixing bar length 2000 mm



MODULES 1524 MM



Suitable to be installed in the zone: **3**

Order no. MDL 125

Dimensions: **1524x365x1700 mm** (WxDxH)
Weight: **65,35 Kg**

Module complete with:
6 trays with rubber and 30 adjustable dividers

MODULES 1225 MM



Suitable to be installed in the zone: **2 3 5**

Order no. MDL 120

Dimensions: **1225x365x1700 mm** (WxDxH)
Weight: **72,95 Kg**

Module complete with:
4 trays with rubber and 16 adjustable dividers
2 drawers
1 shelf with door
1 hinged door



Suitable to be installed in the zone: **2 3 5**

Order no. MDL 121

Dimensions: **1225x365x1700 mm** (WxDxH)
Weight: **70,95 Kg**

Module complete with:
5 trays with rubber and 20 adjustable dividers
1 drawer
1 retractable shelf for tool cases complete with tool cases and boxes

Technical features, see page 5
Accessories see page 9

*approximate measurement

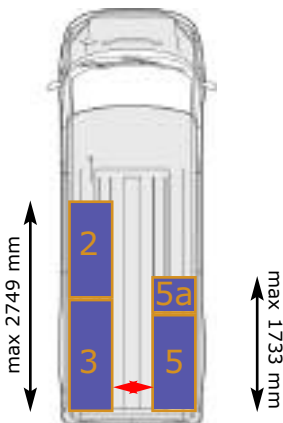

920 mm*



Suitable to be installed in the zone: **2 3 5**

Order no. MDL 122

Dimensions: **1225x365x1700 mm** (WxDxH)
Weight: **55,00 Kg**

Module complete with:
6 trays with rubber and 24 adjustable dividers



Suitable to be installed in the zone: **2**

Order no. MDL 123

Dimensions: **1225x365x1700 mm** (WxDxH)
Weight: **54,65 Kg**

Module complete with:
4 trays with rubber and 16 adjustable dividers
1 shelf with door
1 connection bar with fixing belts for tool cases

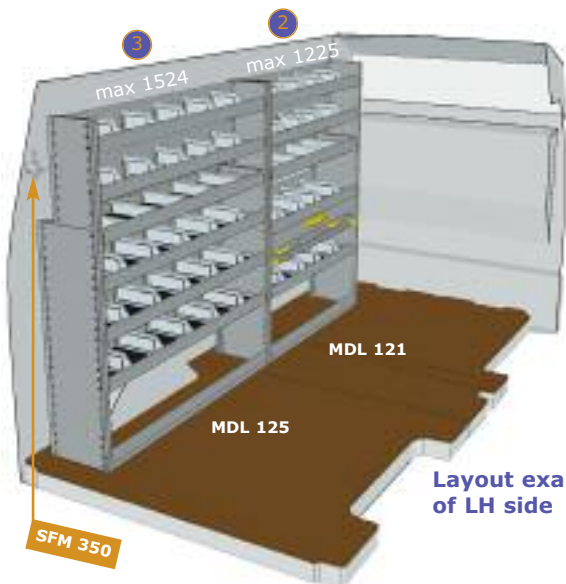

Layout example of LH side



Layout example of RH side



MODULES 1016 MM

MODULES 508 mm



Suitable to be installed in the zone: **2 3 5**

Order no. MDL 114

Dimensions: **1016x365x1700 mm** (WxDxH)

Weight: **62,90 Kg**

Module complete with:

- 4 trays with rubber and 12 adjustable dividers
- 2 drawers
- 1 shelf with door
- 1 hinged door

Suitable to be installed in the zone: **2 3 5**

Order no. MDL 115

Dimensions: **1016x365x1700 mm** (WxDxH)

Weight: **61,80 Kg**

Module complete with:

- 5 trays with rubber and 15 adjustable dividers
- 1 drawer
- 1 retractable shelf for tool cases complete with tool cases and boxes

Suitable to be installed in the zone: **5a**

Order no. MDL 146

Dimensions: **508x365x1700 mm** (WxDxH)

Weight: **30,80 Kg**

Module complete with:

- 6 trays with rubber and 6 adjustable dividers



Suitable to be installed in the zone: **2 3 5**

Order no. MDL 116

Dimensions: **1016x365x1700 mm** (WxDxH)

Weight: **46,70 Kg**

Module complete with:

- 6 trays with rubber and 18 adjustable dividers

Suitable to be installed in the zone: **2**

Order no. MDL 117

Dimensions: **1016x365x1700 mm** (WxDxH)

Weight: **46,50 Kg**

Module complete with:

- 4 trays with rubber and 12 adjustable dividers
- 1 shelf with door
- 1 connection bar with fixing belts for tool cases

Suitable to be installed in the zone: **5a**

Order no. MDL 147

Dimensions: **508x365x1700 mm** (WxDxH)

Weight: **32,70 Kg**

Module complete with:

- 4 trays with rubber and 4 adjustable dividers
- 1 shelf with door
- 1 connection bar with fixing belts for tool cases

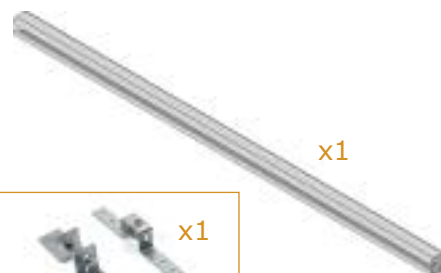
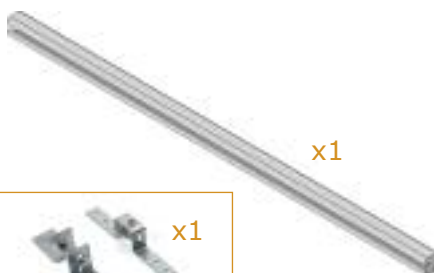

Suitable to be installed in the zone: **5**

Order no. MDL 118

Dimensions: **1016x365x1700 mm** (WxDxH)

Weight: **71,00 Kg**

Module complete with:

- 6 trays with rubber and 18 adjustable dividers
- 1 retractable vice workbench complete with steel vice with 100 mm jaws and 1/2" to 1 1/2" pipe clamp

Order no. SFM 350

Fixing bar: **3500x30x35 mm** (WxDxH)

Weight: **2,93 Kg**

Fixing bar for modules, complete with brackets, bolts and screws.

The bar is necessary to fix the modules to the vehicle.

Order no. SFM 200

Fixing bar: **2000x30x35 mm** (WxDxH)

Weight: **1,88 Kg**

Fixing bar for modules, complete with brackets, bolts and screws.

The bar is necessary to fix the modules to the vehicle.

FLOORINGS AND LININGS

for TRANSIT with RH side sliding door and rear leaf doors, sheet metal side walls

Single rear wheel

A + B Polypropylene linings
Order no. PAN 307

Weight: **23,25 Kg**

Polypropylene linings for:

- LH side wall
- RH side wall and sliding door
- lower section of rear leaf doors

Technical features, see page 5

C Polypropylene linings
Order no. PAR 305

Weight: **2,90 Kg**

Polypropylene linings for:

- upper section of rear leaf doors

D Flooring
Order no. PIL 309

Weight: **55,90 Kg**

12 mm thick wooden flooring phenolic coated and predrilling for lashing hook supports.

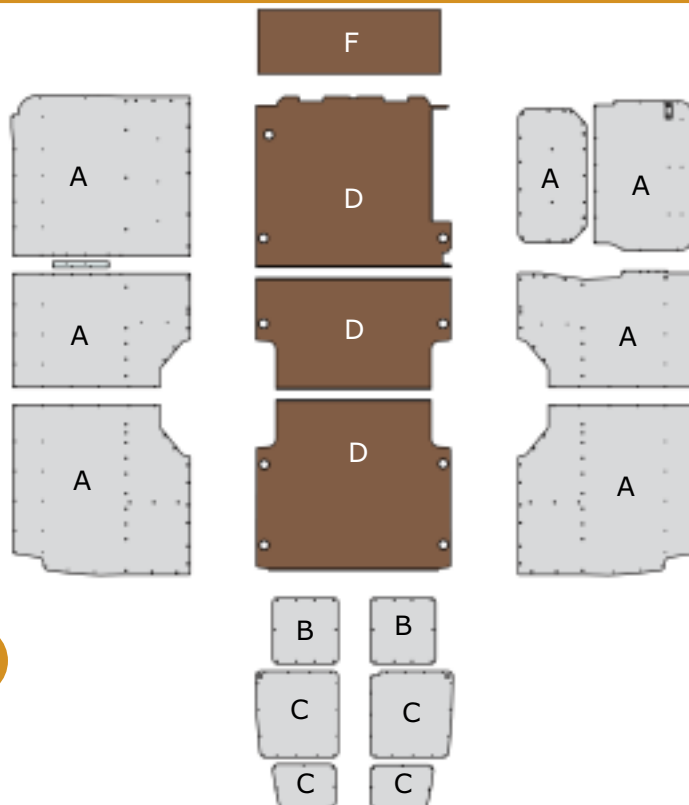
F Bulkhead
Order no. PIR 303
 Weight: **7,35 Kg**
12 mm wooden phenolic coated bulkhead panel.

FLOORINGS AND LININGS

for TRANSIT with RH side sliding door and rear leaf doors, sheet metal side walls

Dual rear wheel

A + B Polypropylene linings
Order no. PAN 307

Weight: **23,25 Kg**

Polypropylene linings for:

- LH side wall
- RH side wall and sliding door
- lower section of rear leaf doors

Technical features, see page 5

C Polypropylene linings
Order no. PAR 305

Weight: **2,90 Kg**

Polypropylene linings for:

- upper section of rear leaf doors

D Flooring
Order no. PIL 310

Weight: **54,50 Kg**

12 mm thick wooden flooring phenolic coated and predrilling for lashing hook supports.

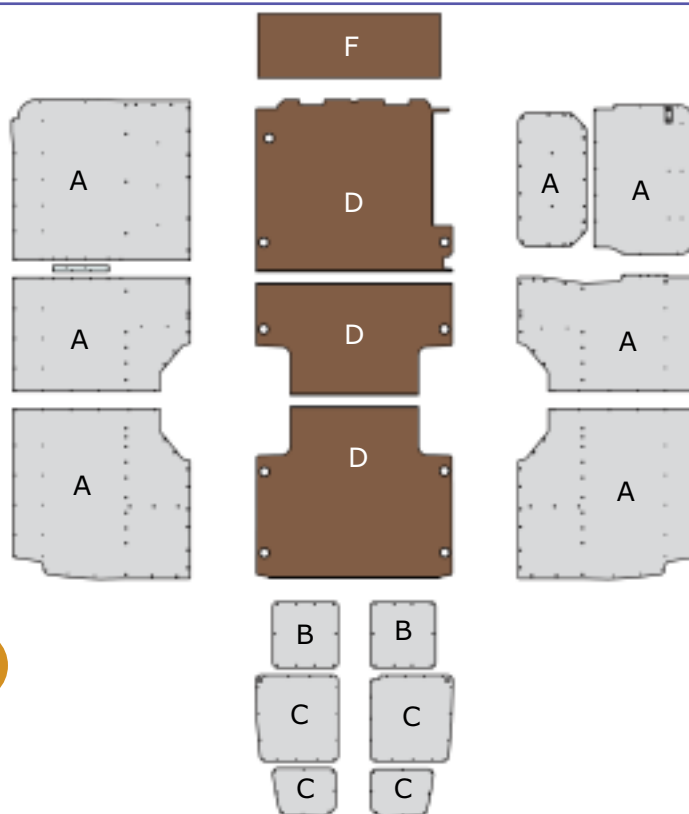
F Bulkhead
Order no. PIR 303
 Weight: **7,35 Kg**
12 mm wooden phenolic coated bulkhead panel.

12,28 m³
L3L H3 wheelbase 3750 mm



TRANSIT VAN LWB EF
high roof Jumbo

ROOF RACK



Order no. POT 308

Dimensions: **4000x1700 mm** (LxW)
Weight: **39,60 Kg**

Roof rack complete with:

- 4 aluminium crossmembers with fixing connectors and rubber profile
- 2 aluminium bars
- 2 4000 mm long aluminium side upstands
- 1 aluminium loading roller

Supplied with **stainless steel** screws for fixing.

Load capacity: 111 Kg (p.u.d.)

Technical
features,
see page 7

LADDER RACK

The ladder rack rail can be mounted on the right or on the left hand side of the vehicle



Order no. POS 308

Dimensions: **4000x1680 mm** (LxW)
Weight: **61,60 Kg**

Ladder rack complete with:

- 4 aluminium crossmembers with fixing connectors and rubber profile
- 1 4000 mm long aluminium side upstand
- 1 aluminium loading roller
- 1 ladder rack rail made from stainless steel and aluminium **ALADIN** series, length 3240 mm

Supplied with **stainless steel** screws for fixing.

Load capacity: 88 Kg (p.u.d.)

LOADING RAMP

Order no. RAM 304

Dimensions: **1150x2500 mm** (WxL)
Weight: **112,55 Kg**

Swivel loading ramp.

Load capacity: 1000 Kg
(p.u.d.)



Technical
features,
see page 8

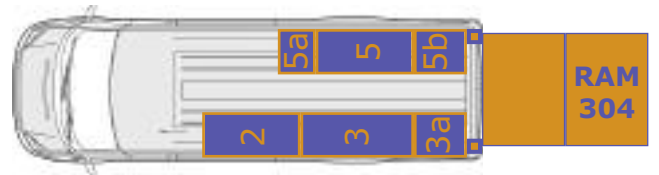

The swivelling loading ramp can be installed also when the modules are fitted.

If the loading ramp is fitted the MDL modules for the areas **3a** and **5b** must not be longer than 508 mm. It is advisable to ask your nearest STORE VAN distributor for a project feasibility study.

READY SOLUTIONS



Order no. MDL S19

Dimensions: **3257x365x1700 mm** (WxDxH). Weight: **133,95 Kg**

Set of 2 modules complete with:

- 8 trays with rubber and 36 adjustable dividers
- 2 drawers
- 1 shelf with door
- 1 hinged door
- 1 fixing bar length 4000 mm



Order no. MDL S20

Dimensions: **2032x365x1700 mm** (WxDxH). Weight: **60,15 Kg**

Module complete with:

- 4 trays with rubber and 20 adjustable dividers
- 1 fixing bar length 3000 mm



MODULES 1524 MM



Suitable to be installed in the zone: **3**

Order no. MDL 125

Dimensions: 1524x365x1700 mm (WxDxH)

Weight: 65,35 Kg

Module complete with:

- 6 trays with rubber and 30 adjustable dividers

MODULES 1225 MM



Suitable to be installed in the zone: **2 3 5**

Order no. MDL 120

Dimensions: 1225x365x1700 mm (WxDxH)

Weight: 72,95 Kg

Module complete with:

- 4 trays with rubber and 16 adjustable dividers
- 2 drawers
- 1 shelf with door
- 1 hinged door



Suitable to be installed in the zone: **2 3 5**

Order no. MDL 121

Dimensions: 1225x365x1700 mm (WxDxH)

Weight: 70,95 Kg

Module complete with:

- 5 trays with rubber and 20 adjustable dividers
- 1 drawer
- 1 retractable shelf for tool cases complete with tool cases and boxes

Technical features, see page 5
Accessories see page 9

*approximate measurement

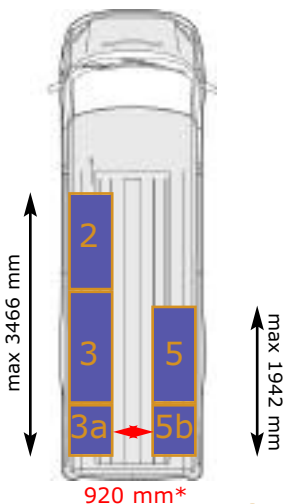

Suitable to be installed in the zone: **2 3 5**

Order no. MDL 122

Dimensions: 1225x365x1700 mm (WxDxH)

Weight: 55,00 Kg

Module complete with:

- 6 trays with rubber and 24 adjustable dividers



Suitable to be installed in the zone: **2**

Order no. MDL 123

Dimensions: 1225x365x1700 mm (WxDxH)

Weight: 54,65 Kg

Module complete with:

- 4 trays with rubber and 16 adjustable dividers
- 1 shelf with door
- 1 connection bar with fixing belts for tool cases

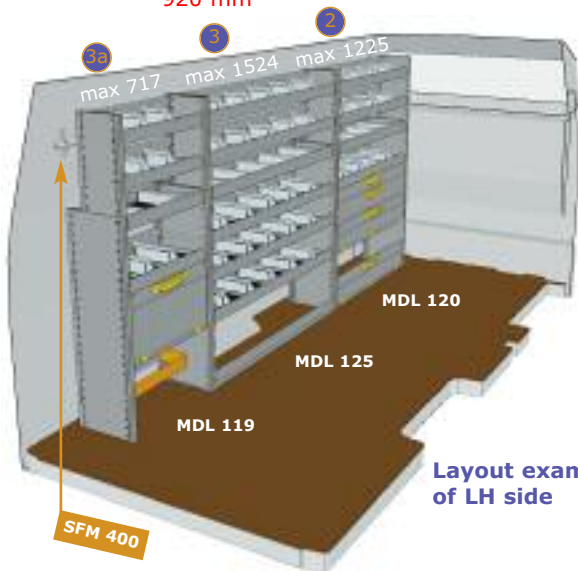

Layout example of LH side

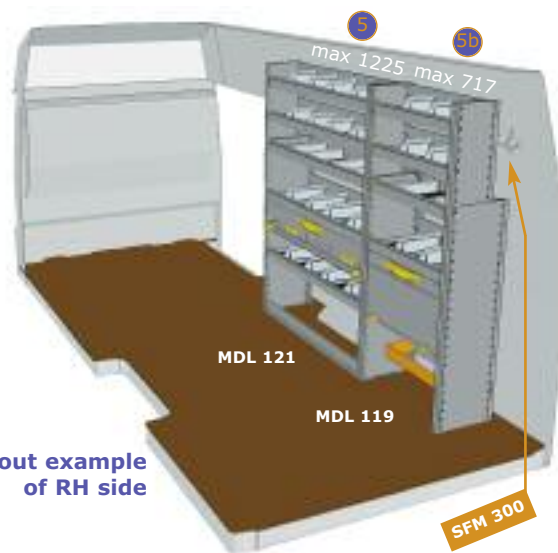

Layout example of RH side



MODULES 1016 MM



Suitable to be installed in the zone: **2 3 5**

Order no. MDL 114

Dimensions: **1016x365x1700 mm** (WxDxH)
Weight: **62,90 Kg**

Module complete with:

- 4 trays with rubber and 12 adjustable dividers
- 2 drawers
- 1 shelf with door
- 1 hinged door

Suitable to be installed in the zone: **2 3 5**

Order no. MDL 115

Dimensions: **1016x365x1700 mm** (WxDxH)
Weight: **61,80 Kg**

Module complete with:

- 5 trays with rubber and 15 adjustable dividers
- 1 drawer
- 1 retractable shelf for tool cases complete with tool cases and boxes



Suitable to be installed in the zone: **2 3 5**

Order no. MDL 116

Dimensions: **1016x365x1700 mm** (WxDxH)
Weight: **46,70 Kg**

Module complete with:

- 6 trays with rubber and 18 adjustable dividers

Suitable to be installed in the zone: **2**

Order no. MDL 117

Dimensions: **1016x365x1700 mm** (WxDxH)
Weight: **46,50 Kg**

Module complete with:

- 4 trays with rubber and 12 adjustable dividers
- 1 shelf with door
- 1 connection bar with fixing belts for tool cases

MODULES 717 mm



Suitable to be installed in the zone: **3a 5b**

Order no. MDL 119

Dimensions: **717x365x1700 mm** (WxDxH)
Weight: **38,10 Kg**

Module complete with:

- 4 trays with rubber and 8 adjustable dividers
- 1 shelf with door
- 1 connection bar with fixing belts for tool cases

MODULES 508 mm



Suitable to be installed in the zone: **3a 5b**

Order no. MDL 146

Dimensions: **508x365x1700 mm** (WxDxH)
Weight: **30,80 Kg**

Module complete with:

- 6 trays with rubber and 6 adjustable dividers



Suitable to be installed in the zone: **3a 5b**

Order no. MDL 147

Dimensions: **508x365x1700 mm** (WxDxH)
Weight: **32,70 Kg**

Module complete with:

- 4 trays with rubber and 4 adjustable dividers
- 1 shelf with door
- 1 connection bar with fixing belts for tool cases

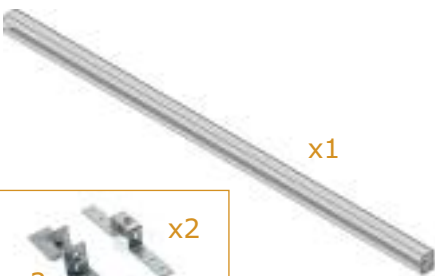

Order no. SFM 400

Fixing bar: **4000x30x35 mm** (WxDxH)
Weight: **3,45 Kg**

Fixing bar for modules, complete with brackets, bolts and screws.

The bar is necessary to fix the modules to the vehicle.

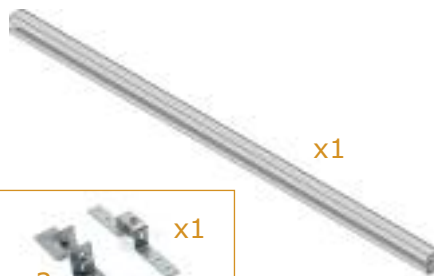

Order no. SFM 300

Fixing bar: **3000x30x35 mm** (WxDxH)
Weight: **2,60 Kg**

Fixing bar for modules, complete with brackets, bolts and screws.

The bar is necessary to fix the modules to the vehicle.



FAMI S.r.l.
 Via Stazione Rossano, 13
 36027 Rosà, Vicenza ITALY
 Tel. +39 0424 585554
 Fax +39 0424 585482
 www.storevan.com
 info@storevan.com

YOUR STORE VAN PARTNER



**PROFESSIONALITY
 IN MOVEMENT**

COD. 50001107