

Fittings for commercial vehicles

Iveco



PROFESSIONALITY IN MOVEMENT

TERMS OF SUPPLY

- Floorings and linings supplied in several parts.
- Floorings, linings, roof racks and ladder racks are supplied **unassembled**.
- Modules are supplied **pre-assembled** complete with fixing material to the vehicle.
- For **product installation** we suggest to contact the expert assistance of our network of **authorised installation centers** (see back cover).
- The products are supplied including **packing**.
- Our products are covered by a **3-years warranty**.
- **Load capacity** data refer to **uniformly distributed loads** (p.u.d.)

CERTIFIED PRODUCTION

Successfully certified, Quality Assurance Certification since over ten years.



CRASH TEST STORE VAN



Passed the **CRASH TEST** carried out according to the recent European regulations. **ECE-R17** with impact at **50 Km/h**.

TESTED AND CERTIFIED SAFETY



STORE VAN has obtained the prestigious **GS** certification for its loading ramps and interior fittings.



STORE VAN also boasts the rare **GS** certification for the universal ladder rack.

Store Van

A TRADEMARK OF FAMI'S GROUP

Fami's constant focus on the market trends, combined with studies for customized products, has been the winning strategy also for the last born brand name – STORE VAN - which offers fittings for commercial vehicles of all types. The accurate designed modules and the perfect adaptability for the most different personalised projects, confirmed the quality and supremacy of Store Van's components.

The achieved success allowed Store Van to become one of the most reliable and popular supplier among the international commercial vehicles producers.



PROFESSIONALITY IN MOVEMENT

Store Van first introduced an innovative installation system without drilling the van bodyworks to fix the equipments, guaranteeing functionality, quality, steadiness and aesthetic features, both for estate cars and for large vans and fleets.

LOGISTIC QUALITY SYSTEMS







Fami's strategy develops through products versatility, while each project becomes exclusive and customised. This strategy, along with advanced industrial processes, originates fitting systems suitable to meet all customers' requirements.

Fami, one of the leading Company in the field of industrial storage systems, gives priority to the technological features but also considers the design and the "soul" of the product, signing each article with a perfect balance of technology and "heart".

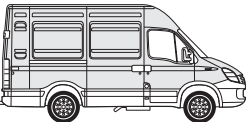
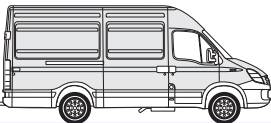

Fami stands out for its high technology and original solutions, like industrial storage, work stations and conductive systems for the electronic industry. All Company's advanced solutions can be employed and diversified in different applications, becoming Fami the leading Company in its field as far competence and competitiveness.

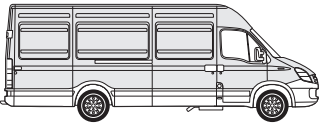

	MODEL	VEHICLE DATA	PAGE
	Daily Van 3000 LR 35S	7,3 m³ L1 H1 wheelbase 3000 mm height 2270 mm	15-18
	Daily Van 3000 HR 35S	9 m³ L1 H2 wheelbase 3000 mm height 2645 mm	19-22
	Daily Van 3000L LR 35S	8,3 m³ L1L H1 wheelbase 3000 mm height 2270 mm	23-26
	Daily Van 3000L HR 35S	10,2 m³ L1L H2 wheelbase 3000 mm height 2645 mm	27-30
	Daily Van 3300 HR 35S - 35C - 40C - 45C - 50C	12,0 m³ L2 H2 wheelbase 3300 mm height 2640-2745 mm	31-34
	Daily Van 3300 XHR 35S - 35C - 40C - 45C - 50C	13,2 m³ L2 H3 wheelbase 3300 mm height 2825-2930 mm	35-38
	Daily Van 3950 HR 35S - 35C - 40C - 45C - 50C	15,6 m³ L3 H2 wheelbase 3950 mm height 2670-2745 mm	39-42
	Daily Van 3950 XHR 35S - 35C - 40C - 45C - 50C - 60C - 65C	17,2 m³ L3 H3 wheelbase 3950 mm height 2869-3025 mm	43-46

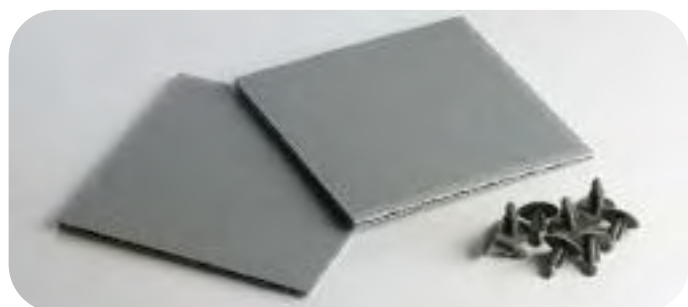

LININGS

4 mm thick polypropylene honeycomb linings with scratchproof surface. Lightweight and robust.



FLOORINGS

Pre-shaped loading floors in one or more jointed pieces with extruded aluminium inserts. Made of 12 mm thick birch and conifer phenolic multi-ply, resin-bonded on both faces and a wear-resistant and slip-proof surface treatment.

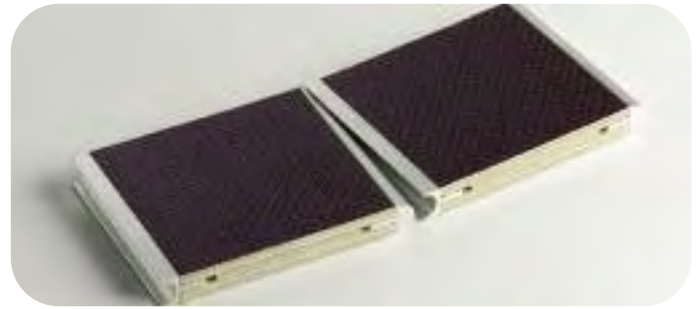

DRAWERS

Easy and intuitive one hand opening with handle operated opening and closing safety stop. Wide range of dividing options of the drawers by means of plastic or metal accessories.

Load capacity: 50 Kg



RETRACTABLE SHELVES

Retractable shelves for one or two tool cases with the possibility of introducing tool cases with different heights and depths.

Load capacity: 50 Kg



VICE WORKBENCHES

Retractable vice workbench complete with steel vice, swivel base, jaws width 100 mm.

Technical features

ALADIN ladder rack rails

with **servo-assisted lowering and lifting system** for ladders weight up to 60 kg.



LOADING RAMPS



Servo assisted loading ramps with tubular steel structure and knurled slip-proof aluminium platform. Connection to the vehicle by means of a telescopic column and self-positioning feet.

Load capacity from: 600 to 1500 Kg.

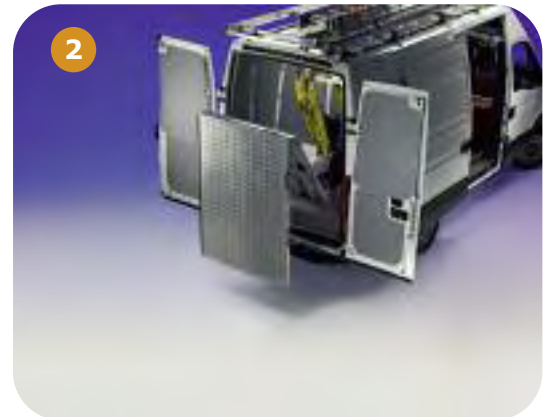

292 mm DEEP TOOL CASES

**Order no. VAL 001****Case with boxes**

Dim. 438x292x67 mm (WxDxH)
Internal solutions with:
2 green, 2 blue, 5 yellow,
10 red boxes.

**Order no. VAL 002****Case with boxes**

Dim. 438x292x67 mm (WxDxH)
Internal solutions with: 8 blue,
8 red boxes.

**Order no. VAL 003****Case with boxes**

Dim. 438x292x102 mm (WxDxH)
Internal solutions with: 2 blue,
2 green, 5 yellow, 10 red boxes.
Upper tray with 20 red and
10 yellow boxes.

**Order no. VAL 004****Case with boxes**

Dim. 438x292x102 mm (WxDxH)
Internal solutions with:
4 green, 4 blue boxes.
Upper tray with 20 red and 10 yellow boxes.

343 mm DEEP TOOL CASES

**Order no. VAL 005****Case with boxes**

Dim. 438x343x67 mm (WxDxH)
Internal solutions with:
2 green, 3 blue, 6 yellow,
12 red boxes.

**Order no. VAL 006****Case with boxes**

Dim. 438x343x67 mm (WxDxH)
Internal solutions with:
8 green boxes.

**Order no. VAL 007****Case with boxes**

Dim. 438x343x102 mm (WxDxH)
Internal solutions with:
2 green, 3 blue, 6 yellow, 12 red
boxes. Upper tray with 24 red and
12 yellow boxes.

**Order no. VAL 008****Case with boxes**

Dim. 438x343x102 mm (WxDxH)
Internal solutions with:
12 blue boxes.
Upper tray with 24 red and 12 yellow boxes.

ACCESSORIES FOR MODULES



Order no. ACS 001
Hand washing kit



Order no. ACS 002
Can holder kit with 20
litres capacity metal can



Order no. ACS 003
Supports with belt
strap for gas cylinders
and extinguishers



Order no. ACS 004
First aid kit



Order no. ACS 005
Paper towel holder kit
with paper towel
Ø 140 mm



Order no. ACS 006
DIN A4 document
holder



Order no. ACS 007
Spray-can holder kit



Order no. ACS 008
Painted aluminium
cable saddles

LOAD RETAINING BARS AND BELTS



Load retaining bar kit available in 3 dimensions:

Order no. ACS 009

Load retaining bar length 1000 mm
Pair of polyester belts length 3260 mm

Order no. ACS 010

Load retaining bar length 1500 mm
Pair of polyester belts length 3260 mm

Order no. ACS 011

Load retaining bar length 2000 mm
Pair of polyester belts length 3260 mm

CRANES



Revolving crane with positioning brake and folding arm. Including 12 V motor and lifting hook sliding on an aluminium guide and electric limit switch, equipped with remote control with cable.

Load capacity from: 150 to 190 Kg.

OPTIONAL ACCESSORY NOT AVAILABLE FOR ALL VEHICLES MODELS

COMPRESSORS AND RETRACTABLE HORIZONTAL SYSTEMS



Retractable horizontal aluminium frames. Mechanical stop of the frame in opening and closing.

Possibility of blocking the shelf in any opening position.

Load capacity: 300 Kg

Extraction: 60%

Vertical compressors 220V - 380V.

Capacity: 50 - 100 LT



COLLAPSIBLE VICE WORKBENCHES



Collapsible vice workbenches with floor support.
Work bench height adjustable.

Top width: 240 / 340 mm

Depth: 1150 mm



LIFTING DOORS



Lifting doors with assisted opening.

Width: 508 / 717 / 1016 / 1225 / 1524 mm

Useful height: 350 / 400 mm



SHELVES



Shelves available for modules:

Length: 508 / 717 / 1016 / 1225 / 1524 mm

Depth: 265 / 365 mm

Front height: 35 mm

Back height: 100 mm

Available with or without polypropylene containers

Strategically strong



Daily - L2 H2 12 m³

- > **FAST ASSEMBLY**
- > **TOTAL MODULARITY**
- > **SAFETY SOUND ABSORBING ELEMENTS BETWEEN THE VARIOUS METAL COMPONENTS**
- > **ERGONOMETRIC SHAPES**
- > **HEIGHT ADJUSTMENT IN PITCH OF 25 mm OF THE VARIOUS ELEMENTS**

Vehicle equipped with:

- 1 ord. no. POS 405 ladder rack (ladder not supplied)
- 1 ord. no. PIL 404 wooden flooring
- 1 ord. no. PAN 405 polypropylene linings
- 1 ord. no. PAR 402 polypropylene linings
- 1 ord. no. PIR 401 wooden phenolic coated bulkhead panel
- 2 ord. no. MDL 119 module
- 1 ord. no. MDL 120 module
- 1 ord. no. MDL 121 module
- 1 ord. no. MDL 122 module
- 1 ord. no. SFM 250 fixing bar length 2500 mm
- 1 ord. no. SFM 350 fixing bar length 3500 mm
- 1 ord. no. ACS 003 support with belt for gas cylinders and extinguishers (extinguisher not supplied)
- 1 ord. no. ACS 004 first aid kit
- 1 ord. no. ACS 005 paper roll holder with paper roll
- 1 ord. no. ACS 007 spray cans holder kit
- 1 ord. no. ACS 008 painted aluminium cable saddles
- 1 ord. no. ACS 010 load retaining bar length 1500 mm



Daily



FLOORINGS AND LININGS

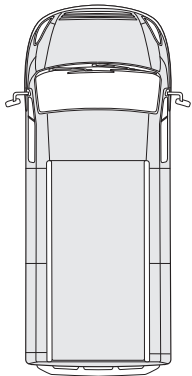

Daily 35S
with RH side sliding door
and rear leaf doors, sheet
metal side walls

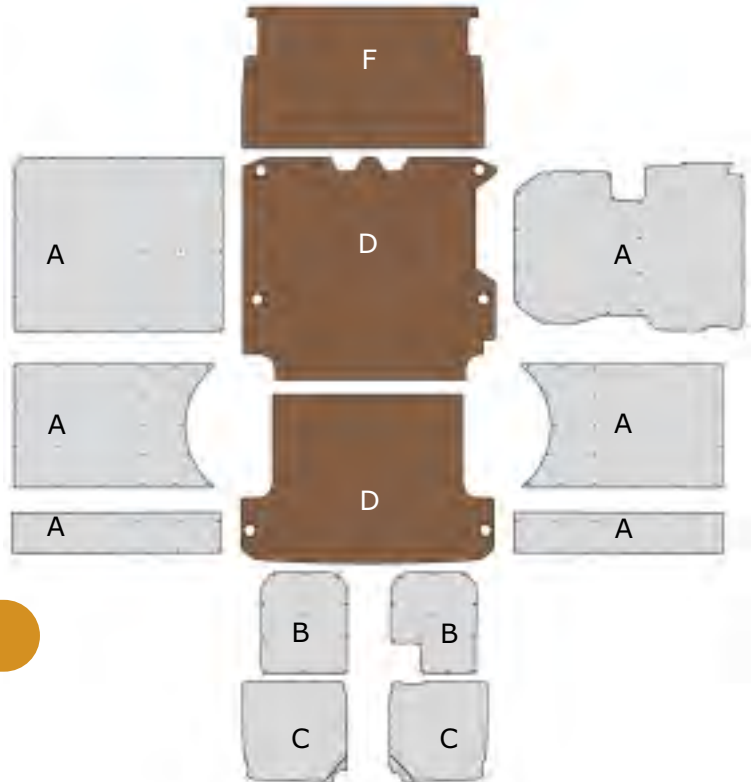

A + B Polypropylene linings
Order no. PAN 401

Weight: **13,20 Kg**

Polypropylene linings for:

- LH side wall
- RH side wall and sliding door
- lower section of rear leaf doors

Technical
features,
see page 5

C Polypropylene linings
Order no. PAR 401

Weight: **1,75 Kg**

Polypropylene linings for:

- upper section of rear leaf doors

D Flooring
Order no. PIL 401

Weight: **35,45 Kg**

12 mm thick wooden flooring phenolic coated and predrilling for lashing hook supports.

F Bulkhead
Order no. PIR 401

Weight: **12,80 Kg**

12 mm wooden phenolic coated bulkhead panel.

ROOF RACK



Order no. POT 401

Dimensions: **2500x1700 mm (WxD)**

Weight: **25,80 Kg**

Roof rack complete with:

- 3 aluminium crossmembers with fixing connectors and rubber profile
- 2 2500 mm long aluminium side upstands
- 1 aluminium loading roller

Supplied with **stainless steel** screws for fixing.

Load capacity: 123 Kg (p.u.d.)

Technical
features,
see page 7

LADDER RACK

The ladder rack rail can be mounted on the right or on the left hand side of the vehicle



Order no. POS 401

Dimensions: **2650x1680 mm (WxD)**

Weight: **55,10 Kg**

Ladder rack complete with:

- 3 aluminium crossmembers with fixing connectors and rubber profile
- 1 2500 mm long aluminium side upstand
- 1 aluminium loading roller
- 1 ladder rack rail made from stainless steel and aluminium **ALADIN** series, length 2650 mm

Supplied with **stainless steel** screws for fixing.

Load capacity: 94 Kg (p.u.d.)

7,3 m³
L1 H1 wheelbase 3000 mm



LOADING RAMP

Order no. RAM 401

Dimensions: **1150x2500 mm** (WxD)
Weight: **114,65 Kg**

Swivel loading ramp.

Load capacity: **1000 Kg**
(p.u.d.)

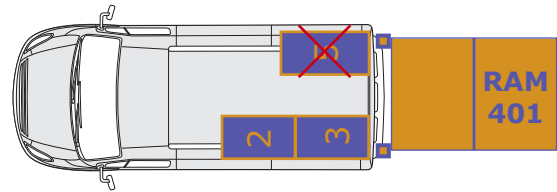

The swivel loading ramp can be installed also when the modules are fitted. If the loading ramp is fitted, the MDL modules for the area **3** must not be longer than 1016 mm. The MDL series modules for area **5** cannot be installed. It is advisable to ask your nearest STORE VAN distributor for a project feasibility study.

Technical features, see page 8

READY SOLUTIONS



Order no. MDL 030

Dimensions: **2032x365x1200 mm** (WxDxH). Weight: **45,15 Kg**
Module complete with:
3 trays with rubber and 15 adjustable dividers

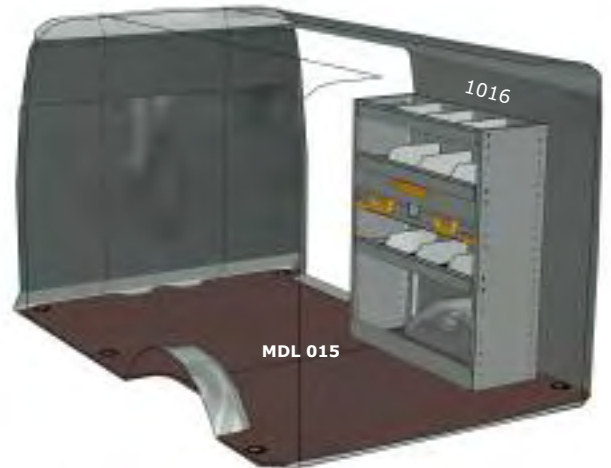

Order no. MDL 015

Dimensions: **1016x365x1200 mm** (WxDxH). Weight: **48,3 Kg**
Module complete with:
3 trays with rubber and 9 adjustable dividers
1 drawer
1 retractable shelf for tool cases complete with tool cases and boxes



MODULES 1016 mm



Suitable to be installed in the zone: **2 3 5**

Order no. MDL 014

Dimensions: **1016x365x1200 mm** (WxDxH)

Weight: **49,4 Kg**

Module complete with:

- 2 trays with rubber and 6 adjustable dividers
- 2 drawers
- 1 shelf with door
- 1 hinged door

Suitable to be installed in the zone: **2 3 5**

Order no. MDL 015

Dimensions: **1016x365x1200 mm** (WxDxH)

Weight: **48,3 Kg**

Module complete with:

- 3 trays with rubber and 9 adjustable dividers
- 1 drawer
- 1 retractable shelf for tool cases complete with tool cases and boxes

Suitable to be installed in the zone: **2 3 5**

Order no. MDL 016

Dimensions: **1016x365x1200 mm** (WxDxH)

Weight: **33,2 Kg**

Module complete with:

- 4 trays with rubber and 12 adjustable dividers

Technical features, see page 5
Accessories see page 9

*approximate measurement

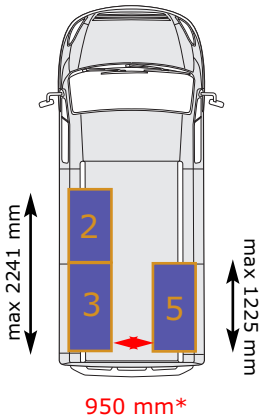

Suitable to be installed in the zone: **2**

Order no. MDL 017

Dimensions: **1016x365x1200 mm** (WxDxH)

Weight: **33 Kg**

Module complete with:

- 2 trays with rubber and 6 adjustable dividers
- 1 shelf with door
- 1 connection bar with fixing belts for tool cases

Suitable to be installed in the zone: **5**

Order no. MDL 018

Dimensions: **1016x365x1200 mm** (WxDxH)

Weight: **57,5 Kg**

Module complete with:

- 4 trays with rubber and 12 adjustable dividers
- 1 retractable vice workbench complete with steel vice with 100 mm jaws and 1/2" to 1 1/2" pipe clamp

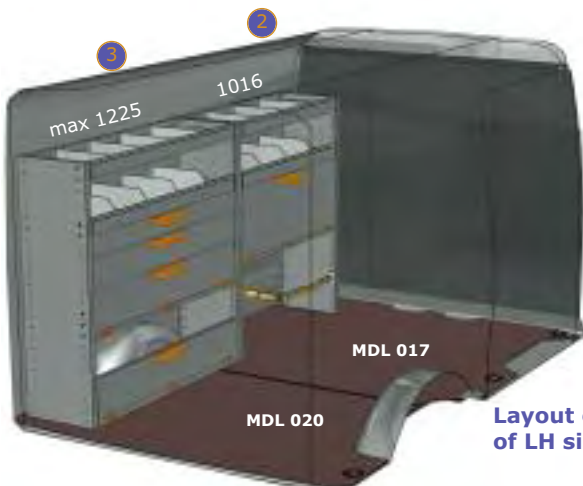

Layout example of LH side

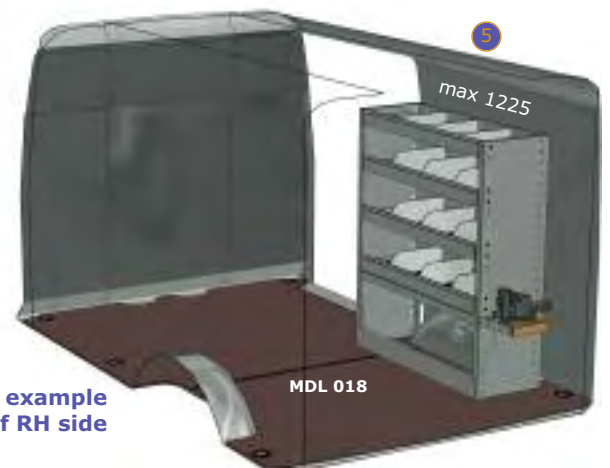

Layout example of RH side



MODULES 1225 mm



Suitable to be installed in the zone: **3 5**

Order no. MDL 020

Dimensions: **1225x365x1200 mm** (WxDxH)

Weight: **57,35 Kg**

Module complete with:

- 2 trays with rubber and 8 adjustable dividers
- 2 drawers
- 1 shelf with door
- 1 hinged door

Suitable to be installed in the zone: **3 5**

Order no. MDL 021

Dimensions: **1225x365x1200 mm** (WxDxH)

Weight: **55,35 Kg**

Module complete with:

- 3 trays with rubber and 12 adjustable dividers
- 1 drawer
- 1 retractable shelf for tool cases complete with tool cases and boxes

Suitable to be installed in the zone: **3 5**

Order no. MDL 022

Dimensions: **1225x365x1200 mm** (WxDxH)

Weight: **39,40 Kg**

Module complete with:

- 4 trays with rubber and 16 adjustable dividers





FLOORINGS AND LININGS

Daily 35S

with RH side sliding door
and rear leaf doors, sheet
metal side walls

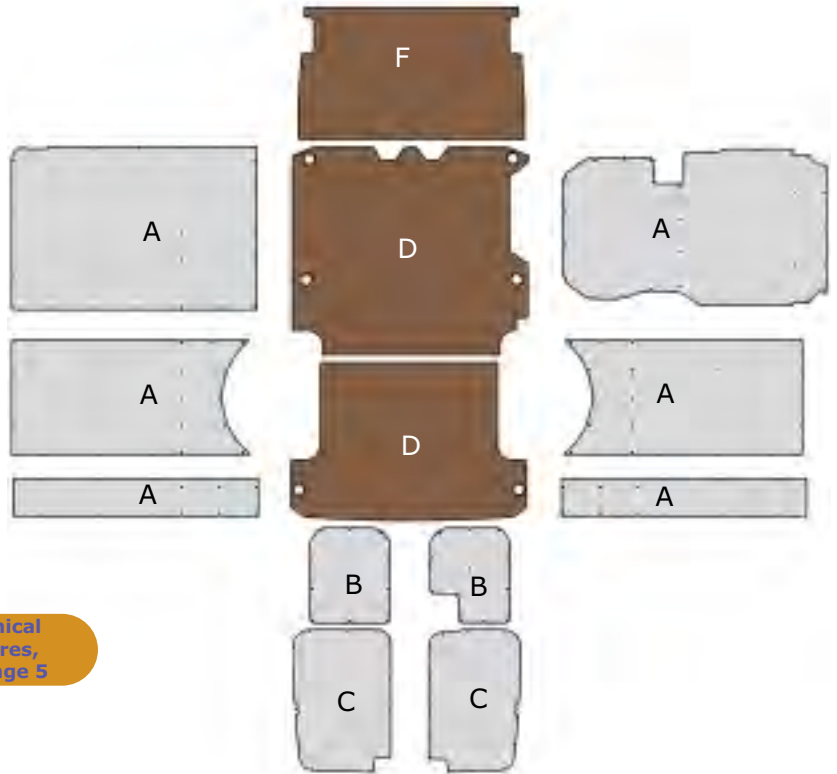
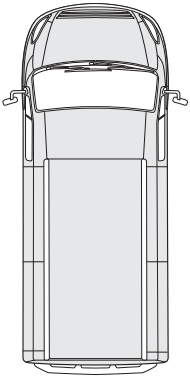
A + B Polypropylene linings
Order no. PAN 402

Weight: **16,30 Kg**

Polypropylene linings for:

- LH side wall
- RH side wall and sliding door
- lower section of rear leaf doors

Technical
features,
see page 5

C Polypropylene linings
Order no. PAR 402

Weight: **2,60 Kg**

Polypropylene linings for:

- upper section of rear leaf doors

D Flooring
Order no. PIL 401

Weight: **35,45 Kg**

12 mm thick wooden flooring phenolic coated and predrilling for lashing hook supports.

F Bulkhead
Order no. PIR 401

Weight: **12,80 Kg**

12 mm wooden phenolic coated bulkhead panel.

ROOF RACK

Order no. POT 402

Dimensions: **3000x1600 mm (WxD)**

Weight: **30,30 Kg**

Roof rack complete with:

- 3 aluminium crossmembers with fixing connectors and rubber profile
- 1 additional crossmember with supports
- 2 3000 mm long aluminium side upstands
- 1 aluminium loading roller

Supplied with **stainless steel** screws for fixing.

Load capacity: 119 Kg (p.u.d.)

Technical
features,
see page 7

LADDER RACK

The ladder rack rail can be mounted on the right or on the left hand side of the vehicle

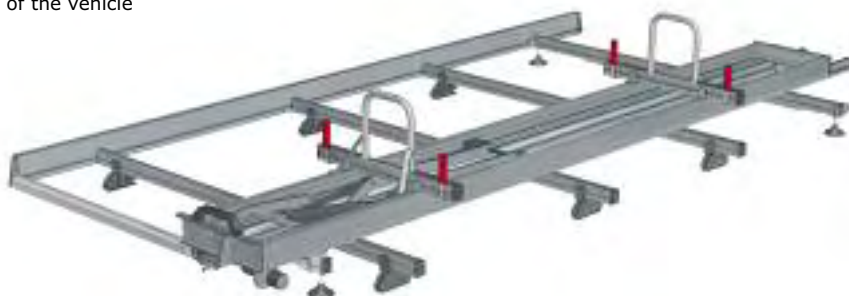
Order no. POS 402

Dimensions: **3240x1580 mm (WxD)**

Weight: **61,60 Kg**

Ladder rack complete with:

- 3 aluminium crossmembers with fixing connectors and rubber profile
- 1 additional crossmember with supports
- 1 3000 mm long aluminium side upstand
- 1 aluminium loading roller
- 1 ladder rack rail made from stainless steel and aluminium **ALADIN** series, length 3240 mm

Supplied with **stainless steel** screws for fixing.

Load capacity: 88 Kg (p.u.d.)

9 m³
L1 H2 wheelbase 3000 mm



20
DAILY Van 3000 HR
35S

LOADING RAMP

Order no. RAM 402

Dimensions: **1150x2500 mm** (WxD)

Weight: **114,85 Kg**

Swivel loading ramp.

Load capacity: **1000 Kg**
(p.u.d.)

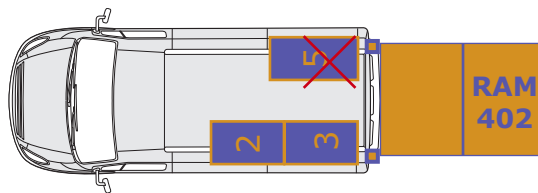

The swivel loading ramp can be installed also when the modules are fitted.

If the loading ramp is fitted, the MDL modules for the area **3** must not be longer than 1016 mm. The MDL series modules for area **5** cannot be installed. It is advisable to ask your nearest STORE VAN distributor for a project feasibility study.

Technical features, see page 8

READY SOLUTIONS



Order no. MDL S13

Dimensions: **2032x365x1700 mm** (WxDxH). Weight: **60,15 Kg**

Module complete with:

- 4 trays with rubber and 20 adjustable dividers
- 1 fixing bar length 3000 mm



Order no. MDL S14

Dimensions: **1016x365x1700 mm** (WxDxH). Weight: **63,35 Kg**

Module complete with:

- 5 trays with rubber and 15 adjustable dividers
- 1 drawer
- 1 retractable shelf for tool cases complete with tool cases and boxes
- 1 fixing bar length 1500 mm



MODULES 1016 mm



Suitable to be installed in the zone: **2 3 5**

Order no. MDL 114

Dimensions: **1016x365x1700 mm** (WxDxH)
Weight: **62,90 Kg**

Module complete with:

- 4 trays with rubber and 12 adjustable dividers
- 2 drawers
- 1 shelf with door
- 1 hinged door

Suitable to be installed in the zone: **2 3 5**

Order no. MDL 115

Dimensions: **1016x365x1700 mm** (WxDxH)
Weight: **61,80 Kg**

Module complete with:

- 5 trays with rubber and 15 adjustable dividers
- 1 drawer
- 1 retractable shelf for tool cases complete with tool cases and boxes

Suitable to be installed in the zone: **2 3 5**

Order no. MDL 116

Dimensions: **1016x365x1700 mm** (WxDxH)
Weight: **46,70 Kg**

Module complete with:

- 6 trays with rubber and 18 adjustable dividers

Technical features, see page 5

Accessories see page 9

*approximate measurement

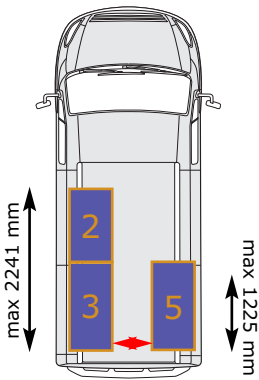

Suitable to be installed in the zone: **2**

Order no. MDL 117

Dimensions: **1016x365x1700 mm** (WxDxH)
Weight: **46,50 Kg**

Module complete with:

- 4 trays with rubber and 12 adjustable dividers
- 1 shelf with door
- 1 connection bar with fixing belts for tool cases

Suitable to be installed in the zone: **5**

Order no. MDL 118

Dimensions: **1016x365x1700 mm** (WxDxH)
Weight: **71,00 Kg**

Module complete with:

- 6 trays with rubber and 18 adjustable dividers
- 1 retractable vice workbench complete with steel vice with 100 mm jaws and 1/2" to 1 1/2" pipe clamp



Layout example of LH side

Layout example of RH side

SFM 250

SFM 150



MODULES 1225 mm



Suitable to be installed in the zone: **3 5**

Order no. MDL 120

Dimensions: **1225x365x1700 mm** (WxDxH)

Weight: **72,95 Kg**

Module complete with:

- 4 trays with rubber and 16 adjustable dividers
- 2 drawers
- 1 shelf with door
- 1 hinged door

Suitable to be installed in the zone: **3 5**

Order no. MDL 121

Dimensions: **1225x365x1700 mm** (WxDxH)

Weight: **70,95 Kg**

Module complete with:

- 5 trays with rubber and 20 adjustable dividers
- 1 drawer
- 1 retractable shelf for tool cases complete with tool cases and boxes

Suitable to be installed in the zone: **3 5**

Order no. MDL 122

Dimensions: **1225x365x1700 mm** (WxDxH)

Weight: **55,00 Kg**

Module complete with:

- 6 trays with rubber and 24 adjustable dividers

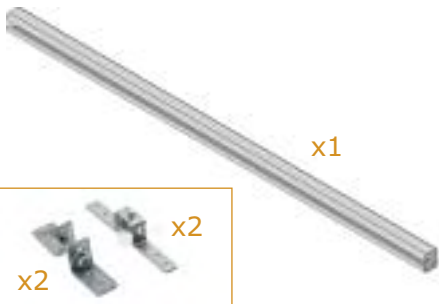

Order no. SFM 150

Fixing bar: **1500x30x35 mm** (WxDxH)

Weight: **1,55 Kg**

Fixing bar for modules, complete with brackets, bolts and screws.

The bar is necessary to fix the modules to the vehicle.



Order no. SFM 250

Fixing bar: **2500x30x35 mm** (WxDxH)

Weight: **2,2 Kg**

Fixing bar for modules, complete with brackets, bolts and screws.

The bar is necessary to fix the modules to the vehicle.



FLOORINGS AND LININGS

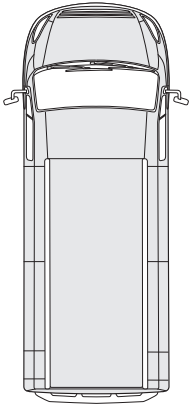

Daily 35S
with RH side sliding door
and rear leaf doors, sheet
metal side walls

A + B Polypropylene linings
Order no. PAN 403

Weight: **15,2 Kg**

Polypropylene linings for:

- LH side wall
- RH side wall and sliding door
- lower section of rear leaf doors

Technical
features,
see page 5

C Polypropylene linings
Order no. PAR 401

Weight: **1,75 Kg**

Polypropylene linings for:

- upper section of rear leaf doors

D Flooring
Order no. PIL 402

Weight: **40,45 Kg**

12 mm thick wooden flooring phenolic coated and predrilling for lashing hook supports.

F Bulkhead
Order no. PIR 401

Weight: **12,80 Kg**

12 mm wooden phenolic coated bulkhead panel.

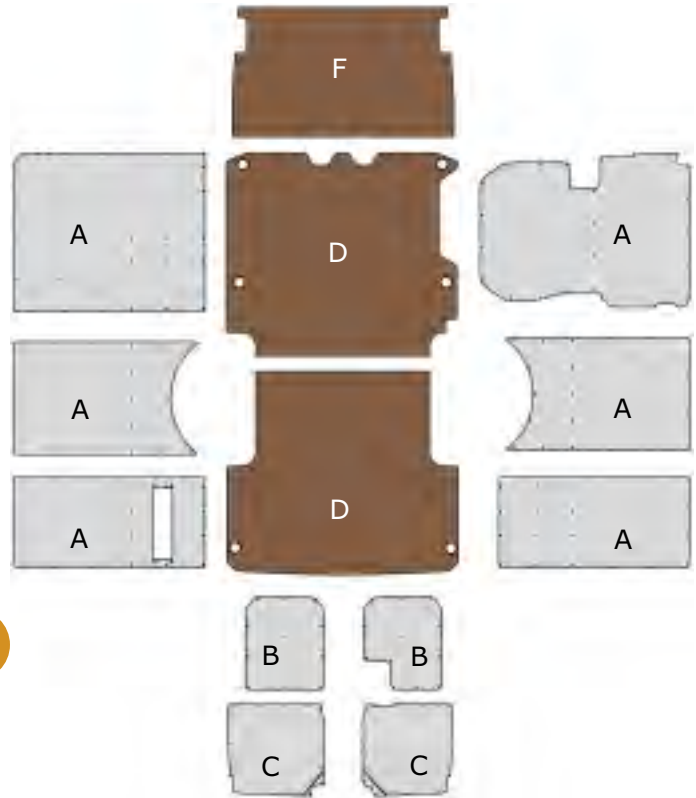

ROOF RACK



Order no. POT 403

Dimensions: **3000x1700 mm (WxD)**

Weight: **31,20 Kg**

Roof rack complete with:

- 3 aluminium crossmembers with fixing connectors and rubber profile
- 1 additional crossmember with supports
- 2 3000 mm long aluminium side upstands
- 1 aluminium loading roller

Supplied with **stainless steel** screws for fixing.

Load capacity: 118 Kg (p.u.d.)

Technical
features,
see page 7

LADDER RACK

The ladder rack rail can be mounted on the right or on the left hand side of the vehicle



Order no. POS 403

Dimensions: **3240x1680 mm (WxD)**

Weight: **65,30 Kg**

Ladder rack complete with:

- 3 aluminium crossmembers with fixing connectors and rubber profile
- 2 additional crossmembers with supports
- 1 3000 mm long aluminium side upstand
- 1 aluminium loading roller
- 1 ladder rack rail made from stainless steel and aluminium **ALADIN** series, length 3240 mm

Supplied with **stainless steel** screws for fixing.

Load capacity: 84 Kg (p.u.d.)

8,3 m³
L1L H1 wheelbase 3000 mm



Daily Van 3000L LR
35S

24

LOADING RAMP

Order no. RAM 401

Dimensions: **1150x2500 mm** (WxD)
Weight: **114,65 Kg**

Swivel loading ramp.

Load capacity: **1000 Kg**
(p.u.d.)

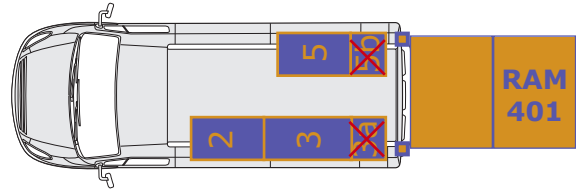

If the loading ramp is fitted, the MDL series modules for areas **3a** and **5b** cannot be installed.

If you wish to install modules in areas **3a** and **5b** you need to ask your nearest STORE VAN distributor for a project feasibility study.

Technical features,
see page 8

READY SOLUTIONS



Order no. MDL S03

Dimensions: **2749x365x1200 mm** (WxDxH). Weight: **75,25 Kg**
Set of 2 modules complete with:
7 trays with rubber and 27 adjustable dividers



Order no. MDL 015

Dimensions: **1016x365x1200 mm** (WxDxH). Weight: **48,3 Kg**
Module complete with:
3 trays with rubber and 9 adjustable dividers
1 drawer
1 retractable shelf for tool cases complete with tool cases and boxes

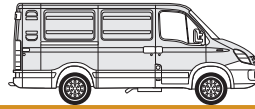

MODULES 508 mm

MODULES 1016 mm



Suitable to be installed in the zone: **3a 5b**

Order no. MDL 046

Dimensions: **508x365x1200 mm** (WxDxH)

Weight: **21,85 Kg**

Module complete with:

- 4 trays with rubber and 4 adjustable dividers

Suitable to be installed in the zone: **2 3 5**

Order no. MDL 014

Dimensions: **1016x365x1200 mm** (WxDxH)

Weight: **49,4 Kg**

Module complete with:

- 2 trays with rubber and 6 adjustable dividers
- 2 drawers
- 1 shelf with door
- 1 hinged door

Suitable to be installed in the zone: **2 3 5**

Order no. MDL 015

Dimensions: **1016x365x1200 mm** (WxDxH)

Weight: **48,3 Kg**

Module complete with:

- 3 trays with rubber and 9 adjustable dividers
- 1 drawer
- 1 retractable shelf for tool cases complete with tool cases and boxes



Suitable to be installed in the zone: **3a 5b**

Order no. MDL 047

Dimensions: **508x365x1200 mm** (WxDxH)

Weight: **23,75 Kg**

Module complete with:

- 2 trays with rubber and 2 adjustable dividers
- 1 shelf with door
- 1 connection bar with fixing belts for tool cases

Suitable to be installed in the zone: **2 3 5**

Order no. MDL 016

Dimensions: **1016x365x1200 mm** (WxDxH)

Weight: **33,2 Kg**

Module complete with:

- 4 trays with rubber and 12 adjustable dividers

Suitable to be installed in the zone: **2**

Order no. MDL 017

Dimensions: **1016x365x1200 mm** (WxDxH)

Weight: **33 Kg**

Module complete with:

- 2 trays with rubber and 6 adjustable dividers
- 1 shelf with door
- 1 connection bar with fixing belts for tool cases

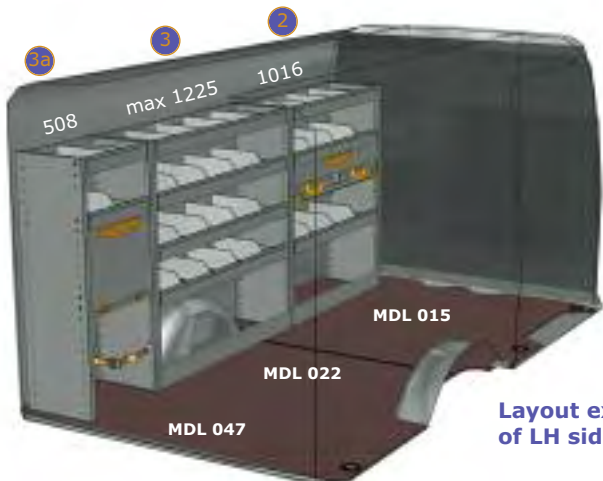

Layout example of LH side

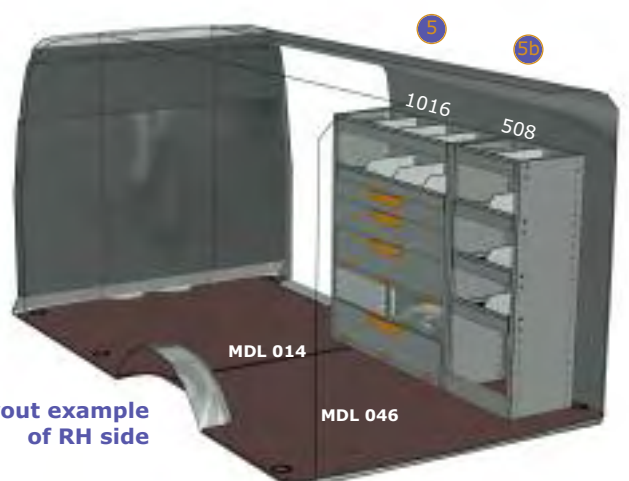

Layout example of RH side

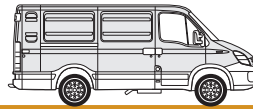

MODULES 1225 mm



Suitable to be installed in the zone: **3**

Order no. MDL 020

Dimensions: **1225x365x1200 mm** (WxDxH)

Weight: **57,35 Kg**

Module complete with:

- 2 trays with rubber and 8 adjustable dividers
- 2 drawers
- 1 shelf with door
- 1 hinged door

Suitable to be installed in the zone: **3**

Order no. MDL 021

Dimensions: **1225x365x1200 mm** (WxDxH)

Weight: **55,35 Kg**

Module complete with:

- 3 trays with rubber and 12 adjustable dividers
- 1 drawer
- 1 retractable shelf for tool cases complete with tool cases and boxes

Suitable to be installed in the zone: **3**

Order no. MDL 022

Dimensions: **1225x365x1200 mm** (WxDxH)

Weight: **39,40 Kg**

Module complete with:

- 4 trays with rubber and 16 adjustable dividers

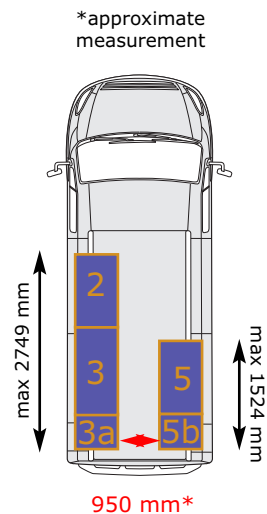

Technical features, see page 5
Accessories see page 9





FLOORINGS AND LININGS

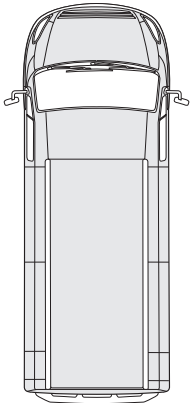

Daily 35S
with RH side sliding door
and rear leaf doors, sheet
metal side walls



A + B Polypropylene linings
Order no. PAN 404

Weight: **18,90 Kg**

Polypropylene linings for:

- LH side wall
- RH side wall and sliding door
- lower section of rear leaf doors

Technical
features,
see page 5

C Polypropylene linings
Order no. PAR 402

Weight: **2,60 Kg**

Polypropylene linings for:

- upper section of rear leaf doors

D Flooring
Order no. PIL 402

Weight: **40,45 Kg**

12 mm thick wooden flooring phenolic coated and predrilling for lashing hook supports.

F Bulkhead
Order no. PIR 401

Weight: **12,80 Kg**

12 mm wooden phenolic coated bulkhead panel.

ROOF RACK



Order no. POT 404

Dimensions: **3000x1600 mm (WxD)**

Weight: **33,90 Kg**

Roof rack complete with:

- 3 aluminium crossmembers with fixing connectors and rubber profile
- 2 additional crossmembers with supports
- 2 3000 mm long aluminium side upstands
- 1 aluminium loading roller

Supplied with **stainless steel** screws for fixing.

Load capacity: 115 Kg (p.u.d.)

Technical
features,
see page 7

LADDER RACK

The ladder rack rail can be mounted on the right or on the left hand side of the vehicle



Order no. POS 404

Dimensions: **3240x1580 mm (WxD)**

Weight: **64,10 Kg**

Ladder rack complete with:

- 3 aluminium crossmembers with fixing connectors and rubber profile
- 2 additional crossmembers with supports
- 1 3000 mm long aluminium side upstand
- 1 aluminium loading roller
- 1 ladder rack rail made from stainless steel and aluminium **ALADIN** series, length 3240 mm

Supplied with **stainless steel** screws for fixing.

Load capacity: 85 Kg (p.u.d.)

10,2 m³
L1L H2 wheelbase 3000 mm



LOADING RAMP

Order no. RAM 402

Dimensions: **1150x2500 mm** (WxD)

Weight: **114,85 Kg**

Swivel loading ramp.

Load capacity: **1000 Kg**
(p.u.d.)

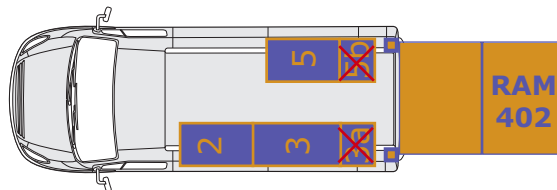

If the loading ramp is fitted, the MDL series modules for areas **3a** and **5b** cannot be installed.

If you wish to install modules in areas **3a** and **5b** you need to ask your nearest STORE VAN distributor for a project feasibility study.

Technical features,
see page 8

READY SOLUTIONS



Order no. MDL S04

Dimensions: **2749x365x1700 mm** (WxDxH) Weight: **103,68 Kg**

Set of 2 modules complete with:

- 10 trays with rubber and 38 adjustable dividers
- 1 fixing bar length 3500 mm



Order no. MDL S05

Dimensions: **1016x365x1700 mm** (WxDxH). Weight: **63,68 Kg**

Module complete with:

- 5 trays with rubber and 15 adjustable dividers
- 1 drawer
- 1 retractable shelf for tool cases complete with tool cases and boxes
- 1 fixing bar length 2000 mm



MODULES 508 mm



Suitable to be installed in the zone: **3a 5b**

Order no. MDL 146

Dimensions: **508x365x1700 mm** (WxDxH)
Weight: **30,80 Kg**
Module complete with:
6 trays with rubber and 6 adjustable dividers



Suitable to be installed in the zone: **3a 5b**

Order no. MDL 147

Dimensions: **508x365x1700 mm** (WxDxH)
Weight: **32,70 Kg**
Module complete with:
4 trays with rubber and 4 adjustable dividers
1 shelf with door
1 connection bar with fixing belts for tool cases

MODULES 1016 mm



Suitable to be installed in the zone: **2 3 5**

Order no. MDL 114

Dimensions: **1016x365x1700 mm** (WxDxH)
Weight: **62,90 Kg**
Module complete with:
4 trays with rubber and 12 adjustable dividers
2 drawers
1 shelf with door
1 hinged door



Suitable to be installed in the zone: **2 3 5**

Order no. MDL 116

Dimensions: **1016x365x1700 mm** (WxDxH)
Weight: **46,70 Kg**
Module complete with:
6 trays with rubber and 18 adjustable dividers



Suitable to be installed in the zone: **2 3 5**

Order no. MDL 115

Dimensions: **1016x365x1700 mm** (WxDxH)
Weight: **61,80 Kg**
Module complete with:
5 trays with rubber and 15 adjustable dividers
1 drawer
1 retractable shelf for tool cases complete with tool cases and boxes



Suitable to be installed in the zone: **2**

Order no. MDL 117

Dimensions: **1016x365x1700 mm** (WxDxH)
Weight: **46,50 Kg**
Module complete with:
4 trays with rubber and 12 adjustable dividers
1 shelf with door
1 connection bar with fixing belts for tool cases



Layout example of LH side



Layout example of RH side



MODULES 1225 mm



Suitable to be installed in the zone: **3**

Order no. MDL 120

Dimensions: **1225x365x1700 mm** (WxDxH)

Weight: **72,95 Kg**

Module complete with:

- 4 trays with rubber and 16 adjustable dividers
- 2 drawers
- 1 shelf with door
- 1 hinged door

Suitable to be installed in the zone: **3**

Order no. MDL 121

Dimensions: **1225x365x1700 mm** (WxDxH)

Weight: **70,95 Kg**

Module complete with:

- 5 trays with rubber and 20 adjustable dividers
- 1 drawer
- 1 retractable shelf for tool cases complete with tool cases and boxes

Suitable to be installed in the zone: **3**

Order no. MDL 122

Dimensions: **1225x365x1700 mm** (WxDxH)

Weight: **55,00 Kg**

Module complete with:

- 6 trays with rubber and 24 adjustable dividers

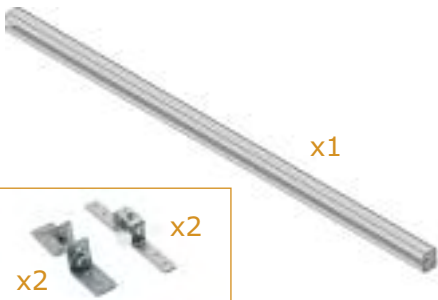

Order no. SFM 300

Fixing bar: **3000x30x35 mm** (WxDxH)

Weight: **2,60 Kg**

Fixing bar for modules, complete with brackets, bolts and screws.

The bar is necessary to fix the modules to the vehicle.

Order no. SFM 200

Fixing bar: **2000x30x35 mm** (WxDxH)

Weight: **1,88 Kg**

Fixing bar for modules, complete with brackets, bolts and screws.

The bar is necessary to fix the modules to the vehicle.

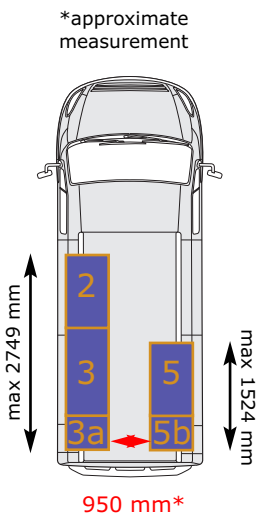

Technical features, see page 5
Accessories see page 9

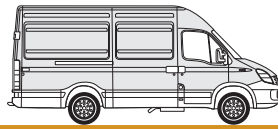

FLOORINGS AND LININGS

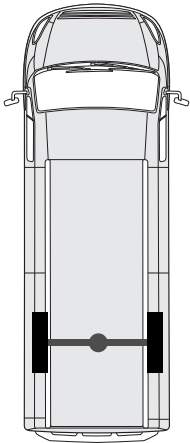

Daily 35S

with RH side sliding door
and rear leaf doors, sheet
metal side walls

Technical
features,
see page 5

A + B Polypropylene linings Order no. PAN 405

Weight: **22,45 Kg**

Polypropylene linings for:

- LH side wall
- RH side wall and sliding door
- lower section of rear leaf doors

C Polypropylene linings Order no. PAR 402

Weight: **2,60 Kg**

Polypropylene linings for:

- upper section of rear leaf doors

D Flooring Order no. PIL 403

Weight: **49,35 Kg**

12 mm thick wooden flooring phenolic coated and predrilling for lashing hook supports.

F Bulkhead Order no. PIR 401

Weight: **12,80 Kg**

12 mm wooden phenolic coated bulkhead panel.

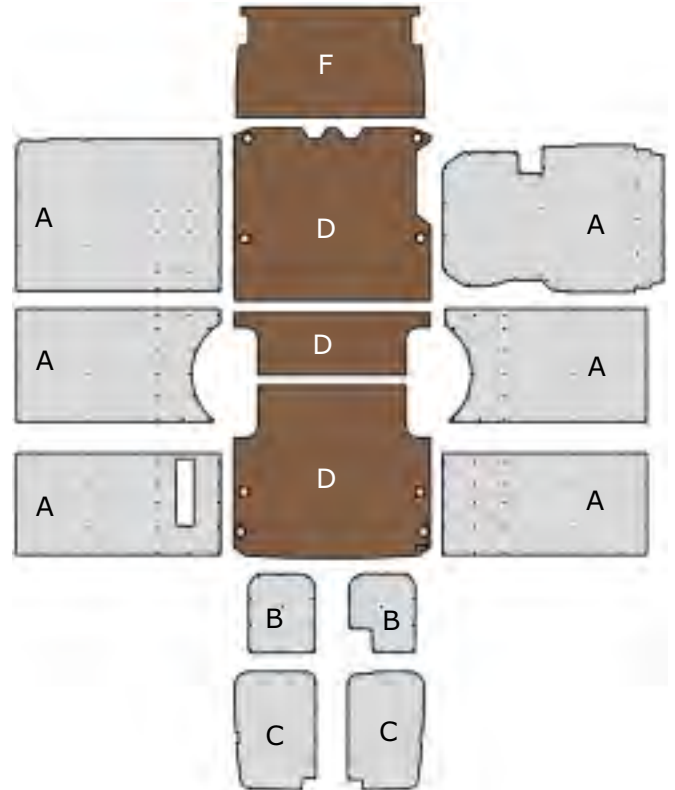

FLOORINGS AND LININGS

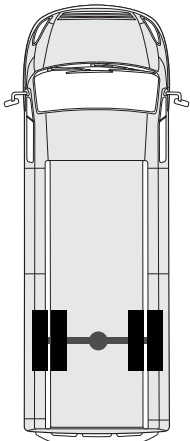

Daily 35C - 40C - 45C - 50C

with RH side sliding door
and rear leaf doors, sheet
metal side walls

Dual rear wheel

Technical
features,
see page 5

A + B Polypropylene linings Order no. PAN 405

Weight: **22,45 Kg**

Polypropylene linings for:

- LH side wall
- RH side wall and sliding door
- lower section of rear leaf doors

C Polypropylene linings Order no. PAR 402

Weight: **2,60 Kg**

Polypropylene linings for:

- upper section of rear leaf doors

D Flooring Order no. PIL 404

Weight: **47,10 Kg**

12 mm thick wooden flooring phenolic coated and predrilling for lashing hook supports.

F Bulkhead Order no. PIR 401

Weight: **12,80 Kg**

12 mm wooden phenolic coated bulkhead panel.

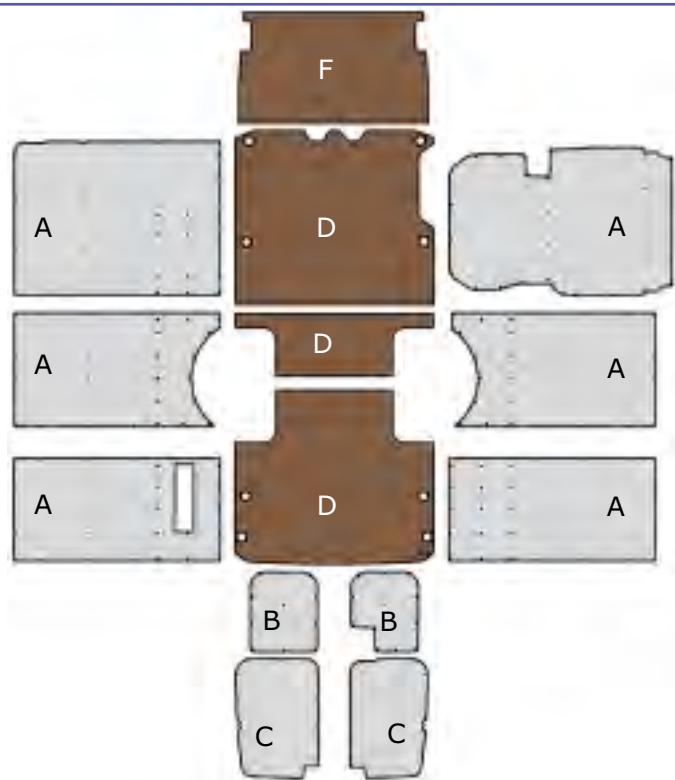

12,0 m³
L2 H2 wheelbase 3300 mm



DAILY Van 3300 HR
35S - 35C - 40C - 45C - 50C

ROOF RACK



Order no. POT 405

Dimensions: **3400x1600 mm** (WxD)
Weight: **31,90 Kg**

Roof rack complete with:

- 3 aluminium crossmembers with fixing connectors and rubber profile
- 1 additional crossmember with supports
- 2 3400 mm long aluminium side upstands
- 1 aluminium loading roller

Supplied with **stainless steel** screws for fixing.
Load capacity: 117 Kg (p.u.d.)

Technical features,
see page 7

LADDER RACK

The ladder rack rail can be mounted on the right or on the left hand side of the vehicle

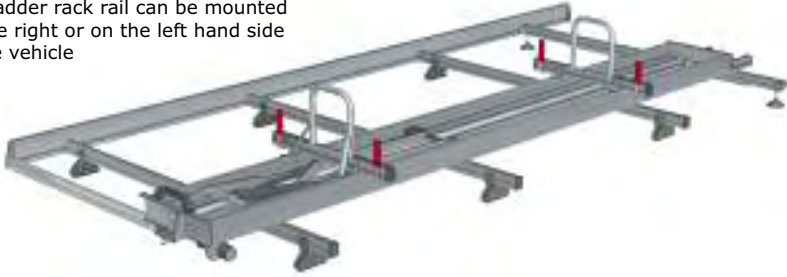

Order no. POS 405

Dimensions: **3400x1580 mm** (WxD)
Weight: **61,40 Kg**

Ladder rack complete with:

- 3 aluminium crossmembers with fixing connectors and rubber profile
- 1 additional crossmember with supports
- 1 3400 mm long aluminium side upstand
- 1 aluminium loading roller
- 1 ladder rack rail made from stainless steel and aluminium **ALADIN** series, length 3240 mm

Supplied with **stainless steel** screws for fixing.
Load capacity: 88 Kg (p.u.d.)

LOADING RAMP

Order no. RAM 403

Dimensions: **1150x3000 mm** (WxD)
Weight: **141,85 Kg**

Swivel loading ramp.

Load capacity: 1500 Kg (p.u.d.)

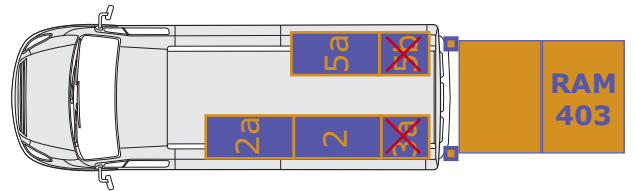

If the loading ramp is fitted, the MDL series modules for areas **3a** and **5b** cannot be installed.

If you wish to install modules in areas **3a** and **5b** you need to ask your nearest STORE VAN distributor for a project feasibility study.

Technical features,
see page 8

READY SOLUTIONS



Order no. MDL S19

Dimensions: **3257x365x1700 mm** (WxDxH). Weight: **133,95 Kg**

Set of 2 modules complete with:

- 8 trays with rubber and 36 adjustable dividers
- 2 drawers
- 1 shelf with door
- 1 hinged door
- 1 fixing bar length 4000 mm



Order no. MDL S20

Dimensions: **2032x365x1700 mm** (WxDxH). Weight: **60,15 Kg**

Module complete with:

- 4 trays with rubber and 20 adjustable dividers
- 1 fixing bar length 3000 mm

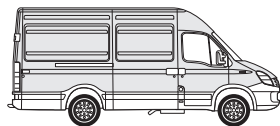

MODULES 717 mm



Suitable to be installed in the zone: **3a 5b**

Order no. MDL 119

Dimensions: **717x365x1700 mm** (WxDxH)

Weight: **38,10 Kg**

Module complete with:

- 4 trays with rubber and 8 adjustable dividers
- 1 shelf with door
- 1 connection bar with fixing belts for tool cases

MODULES 1225 mm



Suitable to be installed in the zone: **2 3 5**

Order no. MDL 120

Dimensions: **1225x365x1700 mm** (WxDxH)

Weight: **72,95 Kg**

Module complete with:

- 4 trays with rubber and 16 adjustable dividers
- 2 drawers
- 1 shelf with door
- 1 hinged door



Suitable to be installed in the zone: **2 3 5**

Order no. MDL 121

Dimensions: **1225x365x1700 mm** (WxDxH)

Weight: **70,95 Kg**

Module complete with:

- 5 trays with rubber and 20 adjustable dividers
- 1 drawer
- 1 retractable shelf for tool cases complete with tool cases and boxes

*approximate measurement

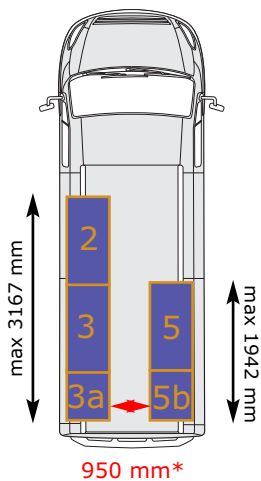

Suitable to be installed in the zone: **2 3 5**

Order no. MDL 122

Dimensions: **1225x365x1700 mm** (WxDxH)

Weight: **55,00 Kg**

Module complete with:

- 6 trays with rubber and 24 adjustable dividers



Suitable to be installed in the zone: **2**

Order no. MDL 123

Dimensions: **1225x365x1700 mm** (WxDxH)

Weight: **54,65 Kg**

Module complete with:

- 4 trays with rubber and 16 adjustable dividers
- 1 shelf with door
- 1 connection bar with fixing belts for tool cases

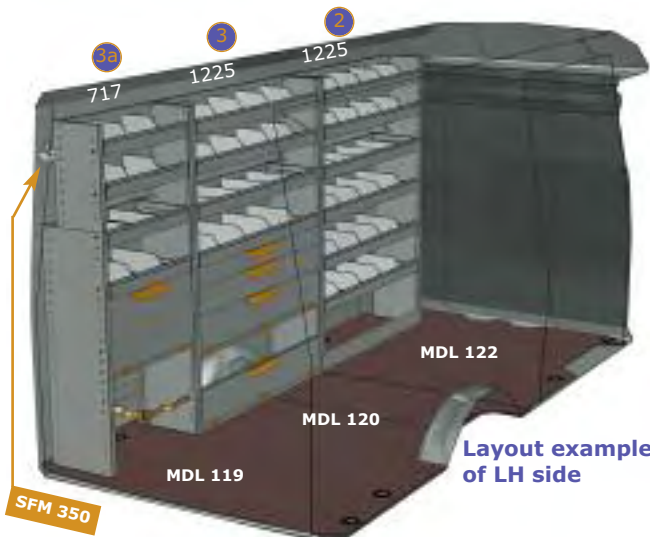

12,0 m³
L2 H2 wheelbase 3300 mm



DAILY Van 3300 HR
35S - 35C - 40C - 45C - 50C

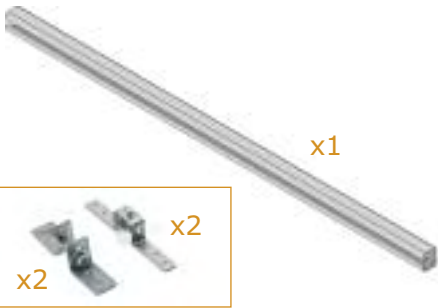

Order no. SFM 350

Fixing bar: **3500x30x35 mm** (WxDxH)

Weight: **2,93 Kg**

Fixing bar for modules, complete with brackets, bolts and screws.

The bar is necessary to fix the modules to the vehicle.

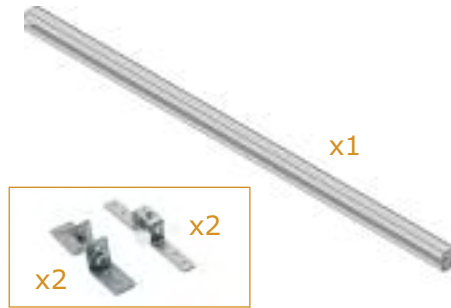

Order no. SFM 250

Fixing bar: **2500x30x35 mm** (WxDxH)

Weight: **2,2 Kg**

Fixing bar for modules, complete with brackets, bolts and screws.

The bar is necessary to fix the modules to the vehicle.

Technical features,
see page 5

Accessories
see page 9





FLOORINGS AND LININGS

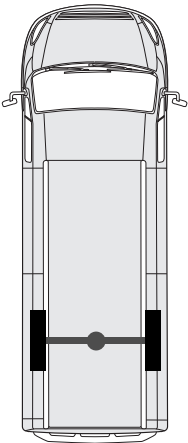

Daily 35S

with RH side sliding door
and rear leaf doors, sheet
metal side walls

Technical
features,
see page 5

A + B Polypropylene linings Order no. PAN 405

Weight: **22,45 Kg**

Polypropylene linings for:

- LH side wall
- RH side wall and sliding door
- lower section of rear leaf doors

C Polypropylene linings Order no. PAR 403

Weight: **3,00 Kg**

Polypropylene linings for:

- upper section of rear leaf doors

D Flooring Order no. PIL 403

Weight: **49,35 Kg**

12 mm thick wooden flooring phenolic coated and predrilling for lashing hook supports.

F Bulkhead Order no. PIR 401

Weight: **12,80 Kg**

12 mm wooden phenolic coated bulkhead panel.

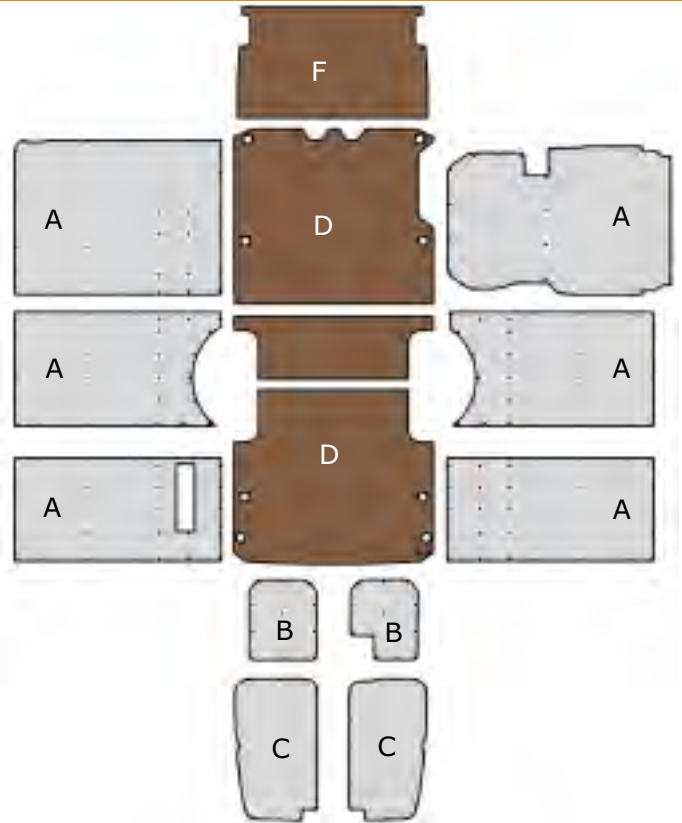

FLOORINGS AND LININGS

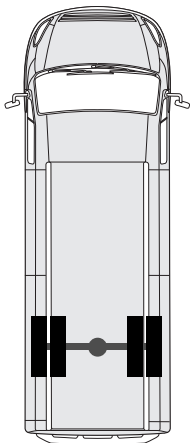

Daily 35C - 40C - 45C - 50C

with RH side sliding door
and rear leaf doors, sheet
metal side walls

Dual rear wheel

Technical
features,
see page 5

A + B Polypropylene linings Order no. PAN 405

Weight: **22,45 Kg**

Polypropylene linings for:

- LH side wall
- RH side wall and sliding door
- lower section of rear leaf doors

C Polypropylene linings Order no. PAR 403

Weight: **3,00 Kg**

Polypropylene linings for:

- upper section of rear leaf doors

D Flooring Order no. PIL 404

Weight: **47,10 Kg**

12 mm thick wooden flooring phenolic coated and predrilling for lashing hook supports.

F Bulkhead Order no. PIR 401

Weight: **12,80 Kg**

12 mm wooden phenolic coated bulkhead panel.

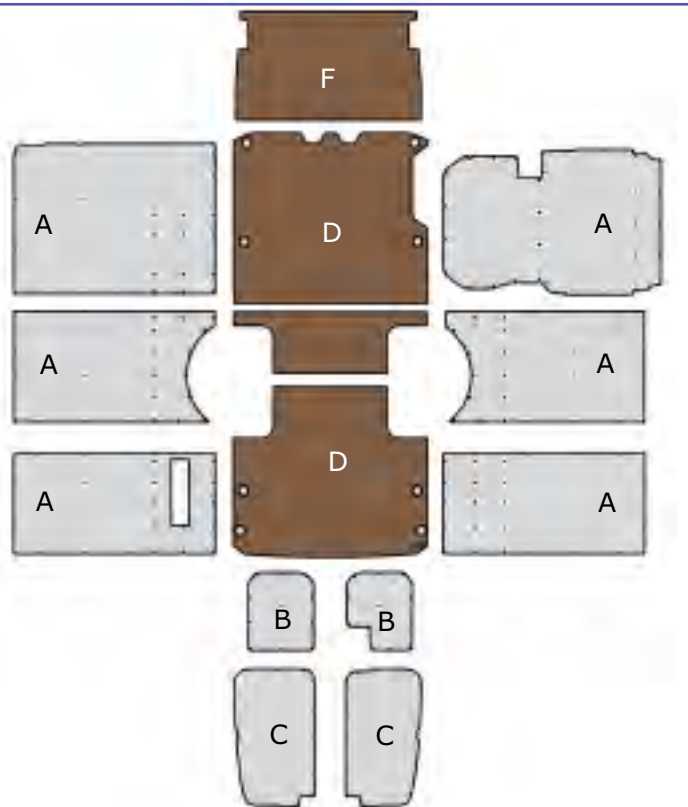

13,2 m³
L2 H3 wheelbase 3300 mm



36

DAILY Van 3300 XHR
35S - 35C - 40C - 45C - 50C

LOADING RAMP

Order no. RAM 404

Dimensions: **1150x3000 mm** (WxD)
Weight: **142,15 Kg**

Swivel loading ramp.

Load capacity: **1500 Kg**
(p.u.d.)

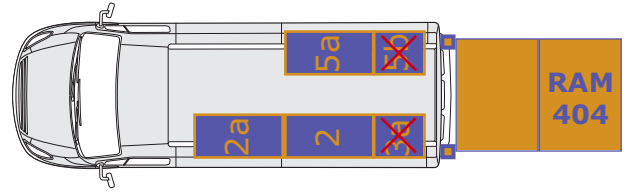

If the loading ramp is fitted, the MDL series modules for areas **3a** and **5b** cannot be installed.
If you wish to install modules in areas **3a** and **5b** you need to ask your nearest STORE VAN distributor for a project feasibility study.

Technical features,
see page 8

READY SOLUTIONS



Order no. MDL S19

Dimensions: **3257x365x1700 mm** (WxDxH). Weight: **133,95 Kg**

Set of 2 modules complete with:

- 8 trays with rubber and 36 adjustable dividers
- 2 drawers
- 1 shelf with door
- 1 hinged door
- 1 fixing bar length 4000 mm



Order no. MDL S20

Dimensions: **2032x365x1700 mm** (WxDxH). Weight: **60,15 Kg**

Module complete with:

- 4 trays with rubber and 20 adjustable dividers
- 1 fixing bar length 3000 mm

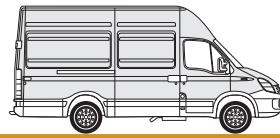

MODULES 717 mm



Suitable to be installed in the zone: **3a 5b**

Order no. MDL 119

Dimensions: **717x365x1700 mm** (WxDxH)
Weight: **38,10 Kg**

Module complete with:

- 4 trays with rubber and 8 adjustable dividers
- 1 shelf with door
- 1 connection bar with fixing belts for tool cases

MODULES 1225 mm



Suitable to be installed in the zone: **2 3 5**

Order no. MDL 120

Dimensions: **1225x365x1700 mm** (WxDxH)
Weight: **72,95 Kg**

Module complete with:

- 4 trays with rubber and 16 adjustable dividers
- 2 drawers
- 1 shelf with door
- 1 hinged door



Suitable to be installed in the zone: **2 3 5**

Order no. MDL 121

Dimensions: **1225x365x1700 mm** (WxDxH)
Weight: **70,95 Kg**

Module complete with:

- 5 trays with rubber and 20 adjustable dividers
- 1 drawer
- 1 retractable shelf for tool cases complete with tool cases and boxes

*approximate measurement

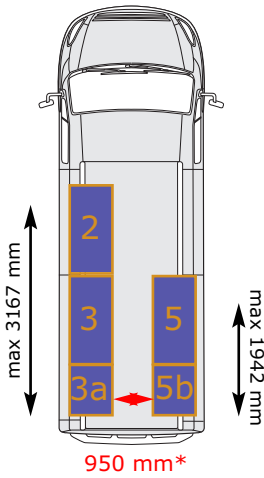

Suitable to be installed in the zone: **2 3 5**

Order no. MDL 122

Dimensions: **1225x365x1700 mm** (WxDxH)
Weight: **55,00 Kg**

Module complete with:

- 6 trays with rubber and 24 adjustable dividers



Suitable to be installed in the zone: **2**

Order no. MDL 123

Dimensions: **1225x365x1700 mm** (WxDxH)
Weight: **54,65 Kg**

Module complete with:

- 4 trays with rubber and 16 adjustable dividers
- 1 shelf with door
- 1 connection bar with fixing belts for tool cases

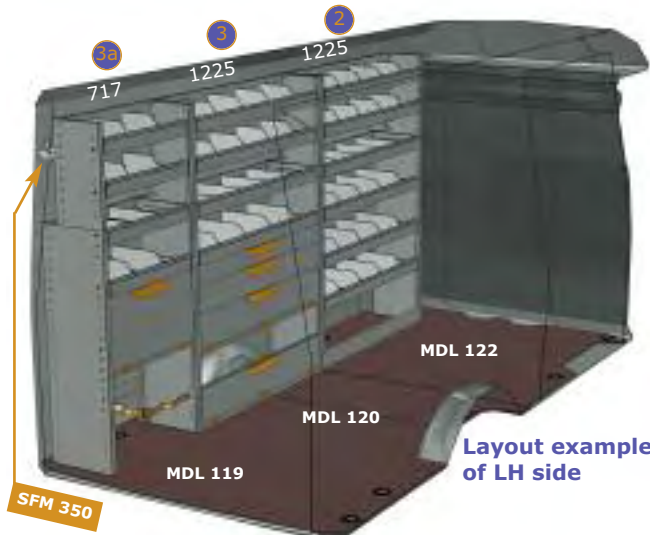

13,2 m³
L2 H3 wheelbase 3300 mm

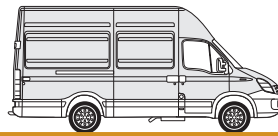

DAILY Van 3300 XHR
35S - 35C - 40C - 45C - 50C

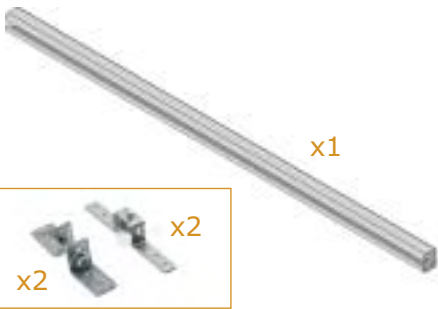

Order no. SFM 350

Fixing bar: **3500x30x35 mm** (WxDxH)

Weight: **2,93 Kg**

Fixing bar for modules, complete with brackets, bolts and screws.

The bar is necessary to fix the modules to the vehicle.

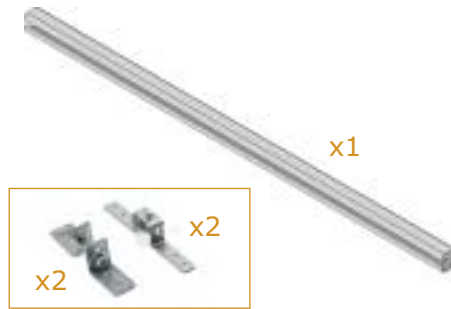

Order no. SFM 250

Fixing bar: **2500x30x35 mm** (WxDxH)

Weight: **2,2 Kg**

Fixing bar for modules, complete with brackets, bolts and screws.

The bar is necessary to fix the modules to the vehicle.

Technical features, see page 5

Accessories see page 9





FLOORINGS AND LININGS

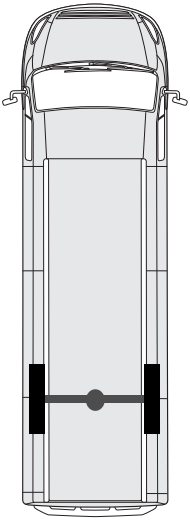

Daily 35S
with RH side sliding door
and rear leaf doors, sheet
metal side walls

Technical
features,
see page 5

A + B Polypropylene linings Order no. PAN 406

Weight: **28,70 Kg**

Polypropylene linings for:

- LH side wall
- RH side wall and sliding door
- lower section of rear leaf doors

C Polypropylene linings Order no. PAR 402

Weight: **2,60 Kg**

Polypropylene linings for:

- upper section of rear leaf doors

D Flooring Order no. PIL 405

Weight: **63,75 Kg**

12 mm thick wooden flooring phenolic coated and predrilling for lashing hook supports.

F Bulkhead Order no. PIR 401

Weight: **12,80 Kg**

12 mm wooden phenolic coated bulkhead panel.

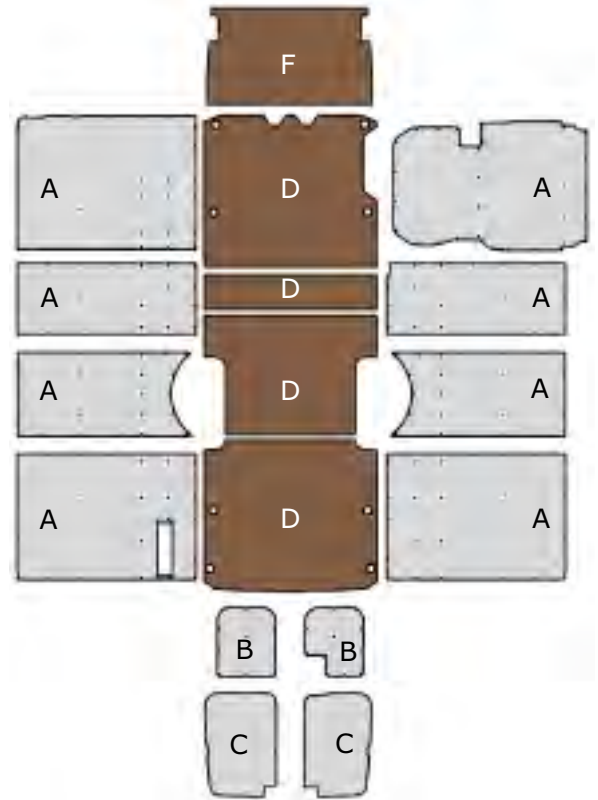

FLOORINGS AND LININGS

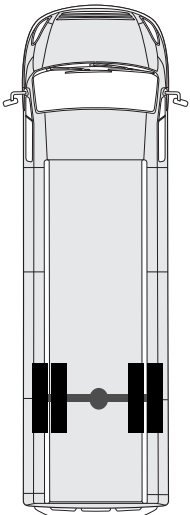

Daily 35C - 40C - 45C - 50C
with RH side sliding door
and rear leaf doors, sheet
metal side walls

Dual rear wheel

Technical
features,
see page 5

A + B Polypropylene linings Order no. PAN 406

Weight: **28,70 Kg**

Polypropylene linings for:

- LH side wall
- RH side wall and sliding door
- lower section of rear leaf doors

C Polypropylene linings Order no. PAR 402

Weight: **2,60 Kg**

Polypropylene linings for:

- upper section of rear leaf doors

D Flooring Order no. PIL 406

Weight: **62,20 Kg**

12 mm thick wooden flooring phenolic coated and predrilling for lashing hook supports.

F Bulkhead Order no. PIR 401

Weight: **12,80 Kg**

12 mm wooden phenolic coated bulkhead panel.

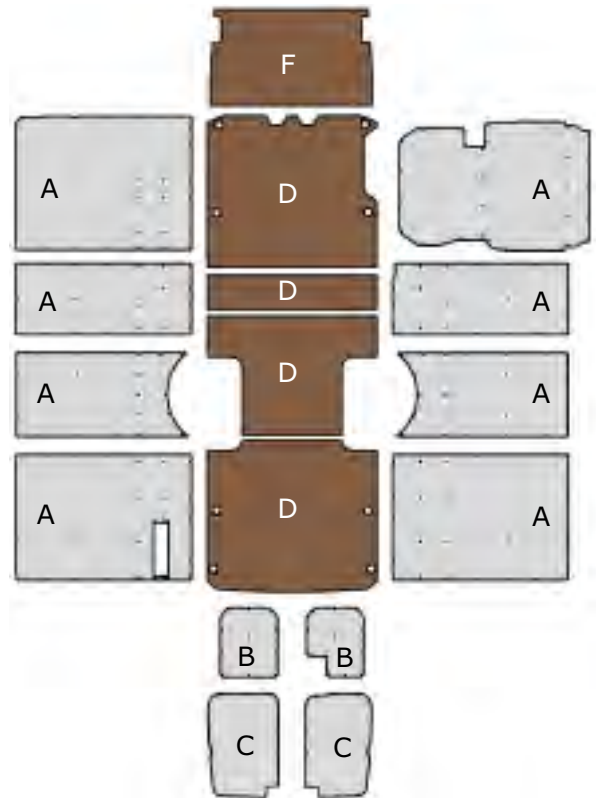

15,6 m³
L3 H2 wheelbase 3950 mm



DAILY Van 3950 HR
35S - 35C - 40C - 45C - 50C

ROOF RACK



Order no. POT 406

Dimensions: **4000x1600 mm** (WxD)
Weight: **33,90 Kg**

Roof rack complete with:

- 3 aluminium crossmembers with fixing connectors and rubber profile
- 1 additional crossmember with supports
- 2 4000 mm long aluminium side upstands
- 1 aluminium loading roller

Supplied with **stainless steel** screws for fixing.
Load capacity: 115 Kg (p.u.d.)

Technical features, see page 7

LADDER RACK

The ladder rack rail can be mounted on the right or on the left hand side of the vehicle

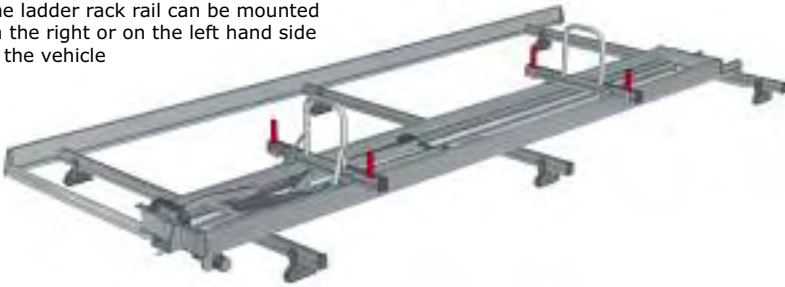

Order no. POS 406

Dimensions: **3400x1580 mm** (WxD)
Weight: **57,80 Kg**

Ladder rack complete with:

- 3 aluminium crossmembers with fixing connectors and rubber profile
- 1 additional crossmember with supports
- 1 3400 mm long aluminium side upstand
- 1 aluminium loading roller
- 1 ladder rack rail made from stainless steel and aluminium **ALADIN** series, length 3240 mm

Supplied with **stainless steel** screws for fixing.
Load capacity: 92 Kg (p.u.d.)

Technical features, see page 8

LOADING RAMP

Order no. RAM 403

Dimensions: **1150x3000 mm** (WxD)
Weight: **141,85 Kg**

Swivel loading ramp.

Load capacity: **1500 Kg (p.u.d.)**

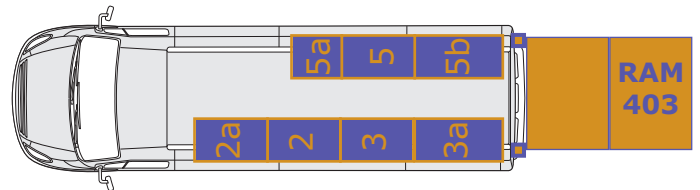

The swivel loading ramp can be installed also when the modules are fitted. If the loading ramp is fitted, the MDL modules for the areas **3a** and **5b** must not be longer than 717 mm. It is advisable to ask your nearest STORE VAN distributor for a project feasibility study.

READY SOLUTIONS



Order no. MDL S06

Dimensions: **3765x365x1700 mm** (WxDxH) Weight: **115,38 Kg**
Set of 2 modules complete with:
8 trays with rubber and 40 adjustable dividers
1 fixing bar length 4500 mm



Order no. MDL S07

Dimensions: **1942x365x1700 mm** (WxDxH). Weight: **113,65 Kg**
Set of 2 modules complete with:
8 trays with rubber and 24 adjustable dividers, 2 shelves with doors,
1 connection bar with fixing belts for tool cases, 2 drawers, 1 hinged door,
1 fixing bar length 3000 mm

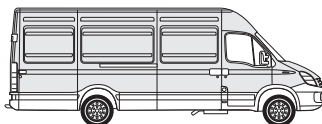

MODULES 1016 mm



Suitable to be installed in the zone: **2 2a 3 3a 5 5b**
Order no. MDL 114
 Dimensions: **1016x365x1700 mm** (WxDxH)
 Weight: **62,90 Kg**
 Module complete with:
 4 trays with rubber and 12 adjustable dividers
 2 drawers
 1 shelf with door
 1 hinged door

Suitable to be installed in the zone: **2 2a 3 3a 5 5b**
Order no. MDL 115
 Dimensions: **1016x365x1700 mm** (WxDxH)
 Weight: **61,80 Kg**
 Module complete with:
 5 trays with rubber and 15 adjustable dividers
 1 drawer
 1 retractable shelf for tool cases complete with tool cases and boxes

Suitable to be installed in the zone: **2 2a 3 3a 5 5b**
Order no. MDL 116
 Dimensions: **1016x365x1700 mm** (WxDxH)
 Weight: **46,70 Kg**
 Module complete with:
 6 trays with rubber and 18 adjustable dividers

MODULES 717 mm



Suitable to be installed in the zone: **5a**
Order no. MDL 119
 Dimensions: **717x365x1700 mm** (WxDxH)
 Weight: **38,10 Kg**
 Module complete with:
 4 trays with rubber and 8 adjustable dividers
 1 shelf with door
 1 connection bar with fixing belts for tool cases

Suitable to be installed in the zone: **2 2a 3a 5b**
Order no. MDL 117
 Dimensions: **1016x365x1700 mm** (WxDxH)
 Weight: **46,50 Kg**
 Module complete with:
 4 trays with rubber and 12 adjustable dividers
 1 shelf with door
 1 connection bar with fixing belts for tool cases

Suitable to be installed in the zone: **5b**
Order no. MDL 118
 Dimensions: **1016x365x1700 mm** (WxDxH)
 Weight: **71,00 Kg**
 Module complete with:
 6 trays with rubber and 18 adjustable dividers
 1 retractable vice workbench complete with steel vice with 100 mm jaws and 1/2" to 1 1/2" pipe clamp



Layout example of LH side

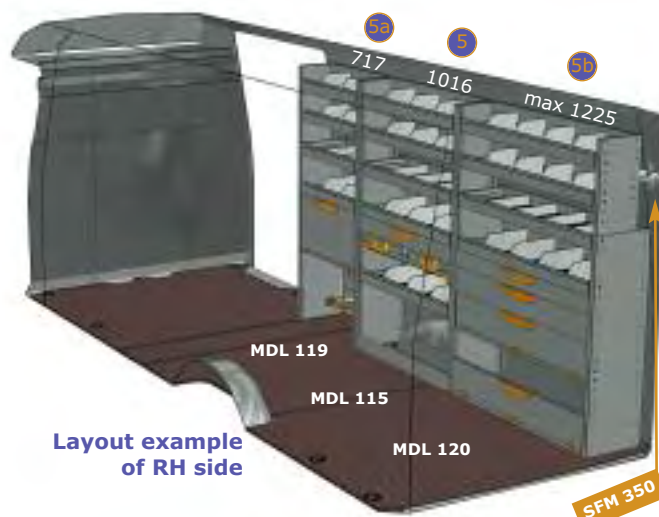

Layout example of RH side

15,6 m³
L3 H2 wheelbase 3950 mm



DAILY Van 3950 HR
35S - 35C - 40C - 45C - 50C

MODULES 1225 mm



Suitable to be installed in the zone: **3a 5b**

Order no. MDL 120

Dimensions: **1225x365x1700 mm** (WxDxH)
Weight: **72,95 Kg**

Module complete with:

- 4 trays with rubber and 16 adjustable dividers
- 2 drawers
- 1 shelf with door
- 1 hinged door



Suitable to be installed in the zone: **3a 5b**

Order no. MDL 121

Dimensions: **1225x365x1700 mm** (WxDxH)
Weight: **70,95 Kg**

Module complete with:

- 5 trays with rubber and 20 adjustable dividers
- 1 drawer
- 1 retractable shelf for tool cases complete with tool cases and boxes



Suitable to be installed in the zone: **3a 5b**

Order no. MDL 122

Dimensions: **1225x365x1700 mm** (WxDxH)
Weight: **55,00 Kg**

Module complete with:

- 6 trays with rubber and 24 adjustable dividers



Suitable to be installed in the zone: **3a 5b**

Order no. MDL 123

Dimensions: **1225x365x1700 mm** (WxDxH)
Weight: **54,65 Kg**

Module complete with:

- 4 trays with rubber and 16 adjustable dividers
- 1 shelf with door
- 1 connection bar with fixing belts for tool cases

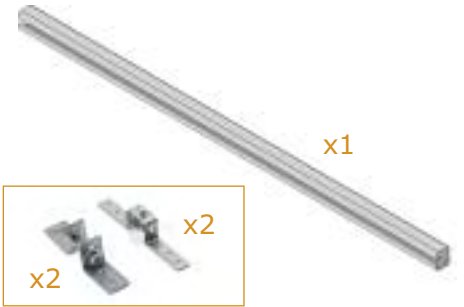

Order no. SFM 350

Fixing bar: **3500x30x35 mm** (WxDxH)

Weight: **2,93 Kg**

Fixing bar for modules, complete with brackets, bolts and screws.

The bar is necessary to fix the modules to the vehicle.

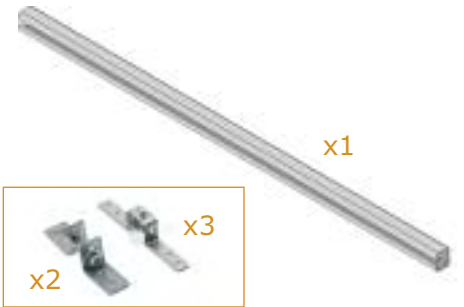

Order no. SFM 450

Fixing bar: **4500x30x35 mm** (WxDxH)

Weight: **3,78 Kg**

Fixing bar for modules, complete with brackets, bolts and screws.

The bar is necessary to fix the modules to the vehicle.

Technical features, see page 5

Accessories see page 9

*approximate measurement

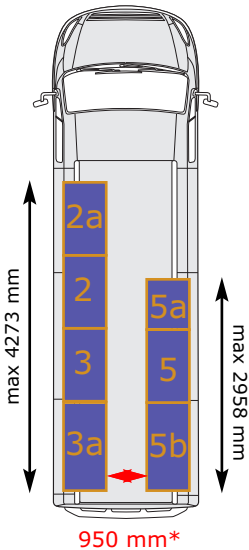

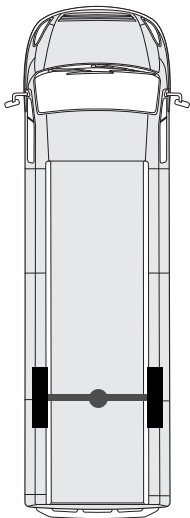

FLOORINGS AND LININGS

**Daily 35S**

with RH side sliding door and rear leaf doors, sheet metal side walls

Technical features, see page 5

A + B Polypropylene linings**Order no. PAN 406**

Weight: **28,70 Kg**

Polypropylene linings for:

- LH side wall
- RH side wall and sliding door
- lower section of rear leaf doors

C Polypropylene linings**Order no. PAR 403**

Weight: **3,00 Kg**

Polypropylene linings for:

- upper section of rear leaf doors

D Flooring**Order no. PIL 405**

Weight: **63,75 Kg**

12 mm thick wooden flooring phenolic coated and predrilling for lashing hook supports.

F Bulkhead**Order no. PIR 401**

Weight: **12,80 Kg**

12 mm wooden phenolic coated bulkhead panel.

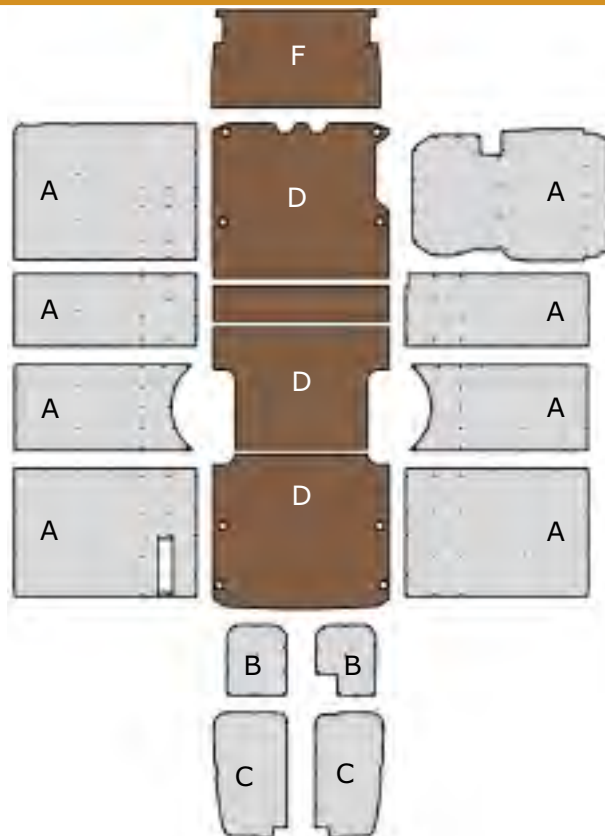

FLOORINGS AND LININGS

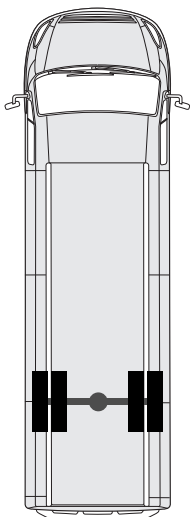
**Daily 35C - 40C - 45C - 50C - 60C - 65C**

with RH side sliding door and rear leaf doors, sheet metal side walls

Dual rear wheel

Technical features, see page 5

A + B Polypropylene linings**Order no. PAN 406**

Weight: **28,70 Kg**

Polypropylene linings for:

- LH side wall
- RH side wall and sliding door
- lower section of rear leaf doors

C Polypropylene linings**Order no. PAR 403**

Weight: **3,00 Kg**

Polypropylene linings for:

- upper section of rear leaf doors

D Flooring**Order no. PIL 406**

Weight: **62,20 Kg**

12 mm thick wooden flooring phenolic coated and predrilling for lashing hook supports.

F Bulkhead**Order no. PIR 401**

Weight: **12,80 Kg**

12 mm wooden phenolic coated bulkhead panel.

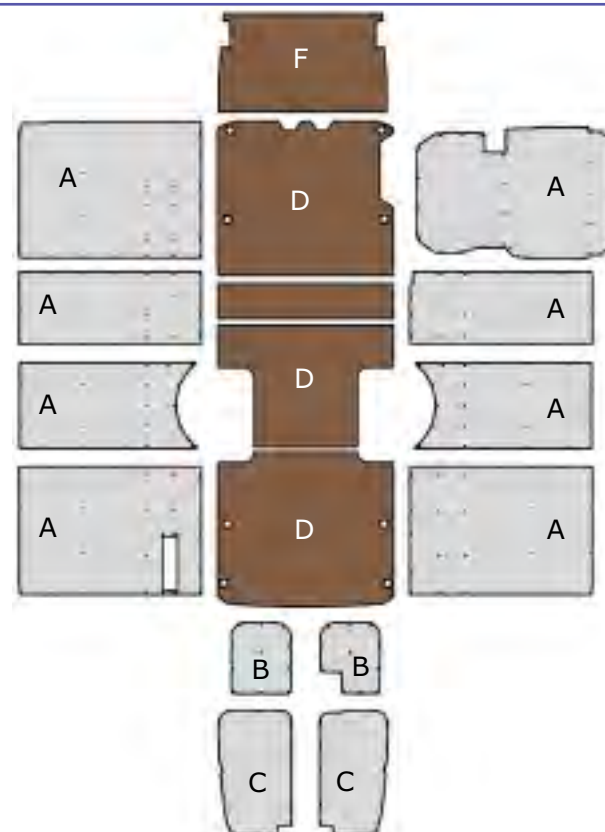

17,2 m³
L3 H3 wheelbase 3950 mm



DAILY Van 3950 XHR
35S - 35C - 40C - 45C - 50C - 60C - 65C

LOADING RAMP

Order no. RAM 404

Dimensions: **1150x3000 mm** (WxD)
Weight: **142,15 Kg**

Swivel loading ramp.

Load capacity: **1500 Kg**
(p.u.d.)

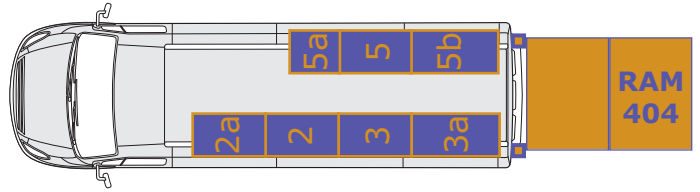

The swivel loading ramp can be installed also when the modules are fitted. If the loading ramp is fitted, the MDL modules for the areas **3a** and **5b** must not be longer than 717 mm. It is advisable to ask your nearest STORE VAN distributor for a project feasibility study.

Technical features,
see page 8

READY SOLUTIONS



Order no. MDL S06

Dimensions: **3765x365x1700 mm** (WxDxH) Weight: **115,38 Kg**
Set of 2 modules complete with:
8 trays with rubber and 40 adjustable dividers
1 fixing bar length 4500 mm



Order no. MDL S07

Dimensions: **1942x365x1700 mm** (WxDxH). Weight: **113,65 Kg**
Set of 2 modules complete with:
8 trays with rubber and 24 adjustable dividers
2 shelves with doors,
1 connection bar with fixing belts for tool cases
2 drawers
1 hinged door
1 fixing bar length 3000 mm



MODULES 1016 mm



Suitable to be installed in the zone: **2 2a 3**

Order no. **MDL 114** **3a 5 5b**

Dimensions: **1016x365x1700 mm** (WxDxH)

Weight: **62,90 Kg**

Module complete with:

- 4 trays with rubber and 12 adjustable dividers
- 2 drawers
- 1 shelf with door
- 1 hinged door

Suitable to be installed in the zone: **2 2a 3**

Order no. **MDL 115** **3a 5 5b**

Dimensions: **1016x365x1700 mm** (WxDxH)

Weight: **61,80 Kg**

Module complete with:

- 5 trays with rubber and 15 adjustable dividers
- 1 drawer
- 1 retractable shelf for tool cases complete with tool cases and boxes

Suitable to be installed in the zone: **2 2a 3**

Order no. **MDL 116** **3a 5 5b**

Dimensions: **1016x365x1700 mm** (WxDxH)

Weight: **46,70 Kg**

Module complete with:

- 6 trays with rubber and 18 adjustable dividers

MODULES 717 mm



Suitable to be installed in the zone: **5a**

Order no. **MDL 119**

Dimensions: **717x365x1700 mm** (WxDxH)

Weight: **38,10 Kg**

Module complete with:

- 4 trays with rubber and 8 adjustable dividers
- 1 shelf with door
- 1 connection bar with fixing belts for tool cases

Suitable to be installed in the zone: **2 2a 3a**

Order no. **MDL 117** **5b**

Dimensions: **1016x365x1700 mm** (WxDxH)

Weight: **46,50 Kg**

Module complete with:

- 4 trays with rubber and 12 adjustable dividers
- 1 shelf with door
- 1 connection bar with fixing belts for tool cases

Suitable to be installed in the zone: **5b**

Order no. **MDL 118**

Dimensions: **1016x365x1700 mm** (WxDxH)

Weight: **71,00 Kg**

Module complete with:

- 6 trays with rubber and 18 adjustable dividers
- 1 retractable vice workbench complete with steel vice with 100 mm jaws and 1/2" to 1 1/2" pipe clamp



Layout example of LH side

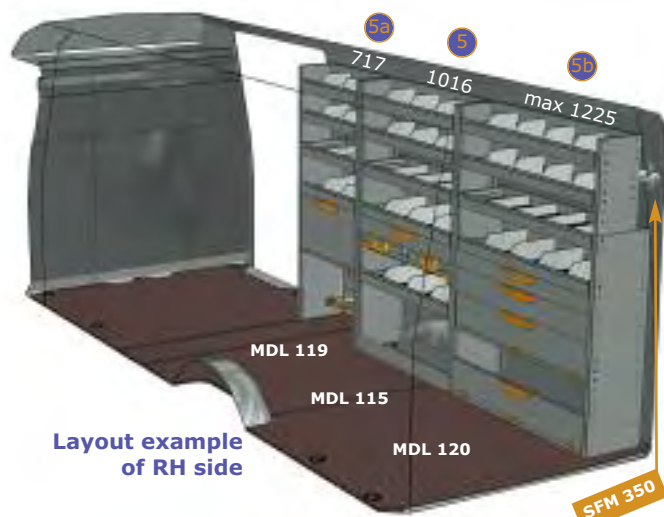

Layout example of RH side

17,2 m³
L3 H3 wheelbase 3950 mm



DAILY Van 3950 XHR
35S - 35C - 40C - 45C - 50C - 60C - 65C

MODULES 1225 mm



Suitable to be installed in the zone: **3a 5b**

Order no. MDL 120

Dimensions: **1225x365x1700 mm** (WxDxH)

Weight: **72,95 Kg**

Module complete with:

- 4 trays with rubber and 16 adjustable dividers
- 2 drawers
- 1 shelf with door
- 1 hinged door



Suitable to be installed in the zone: **3a 5b**

Order no. MDL 121

Dimensions: **1225x365x1700 mm** (WxDxH)

Weight: **70,95 Kg**

Module complete with:

- 5 trays with rubber and 20 adjustable dividers
- 1 drawer
- 1 retractable shelf for tool cases complete with tool cases and boxes



Suitable to be installed in the zone: **3a 5b**

Order no. MDL 122

Dimensions: **1225x365x1700 mm** (WxDxH)

Weight: **55,00 Kg**

Module complete with:

- 6 trays with rubber and 24 adjustable dividers



Suitable to be installed in the zone: **3a 5b**

Order no. MDL 123

Dimensions: **1225x365x1700 mm** (WxDxH)

Weight: **54,65 Kg**

Module complete with:

- 4 trays with rubber and 16 adjustable dividers
- 1 shelf with door
- 1 connection bar with fixing belts for tool cases

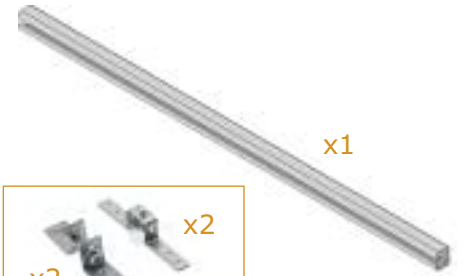

Order no. SFM 350

Fixing bar: **3500x30x35 mm** (WxDxH)

Weight: **2,93 Kg**

Fixing bar for modules, complete with brackets, bolts and screws.

The bar is necessary to fix the modules to the vehicle.

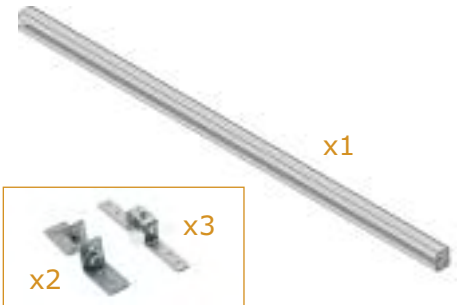

Order no. SFM 450

Fixing bar: **4500x30x35 mm** (WxDxH)

Weight: **3,78 Kg**

Fixing bar for modules, complete with brackets, bolts and screws.

The bar is necessary to fix the modules to the vehicle.

Technical features, see page 5

Accessories see page 9

*approximate measurement

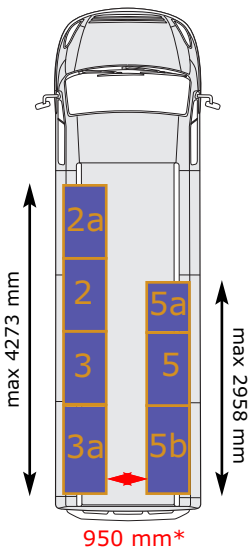



FAMI S.r.l.
Via Stazione Rossano 13
36027 Rosà, Vicenza ITALY
Tel. +39 0424 585455
fax +39 0424 585482
www.storevan.com
info@storevan.com

YOUR STORE VAN PARTNER



**PROFESSIONALITÀ
IN MOVIMENTO**