

# Fittings for commercial vehicles

## Opel

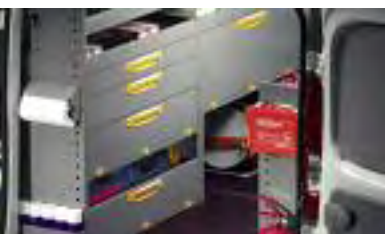

PROFESSIONALITY IN MOVEMENT

## TERMS OF SUPPLY

- Floorings and linings supplied in several parts.
- Floorings, linings, roof racks and ladder racks are supplied **unassembled**.
- Modules are supplied **pre-assembled** complete with fixing material to the vehicle.
- For **product installation** we suggest to contact the expert assistance of our network of **authorised installation centers** (see back cover).
- The products are supplied including **packing**.
- Our products are covered by a **3-years warranty**.
- **Load capacity** data refer to **uniformly distributed loads** (p.u.d.)

## CERTIFIED PRODUCTION

Successfully certified, Quality Assurance Certification since over ten years.



## CRASH TEST STORE VAN



Passed the **CRASH TEST** carried out according to the recent European regulations. **ECE-R17** with impact at **50 Km/h**.



TESTED AND CERTIFIED SAFETY



STORE VAN has obtained the prestigious **GS** certification for its loading ramps and interior fittings.

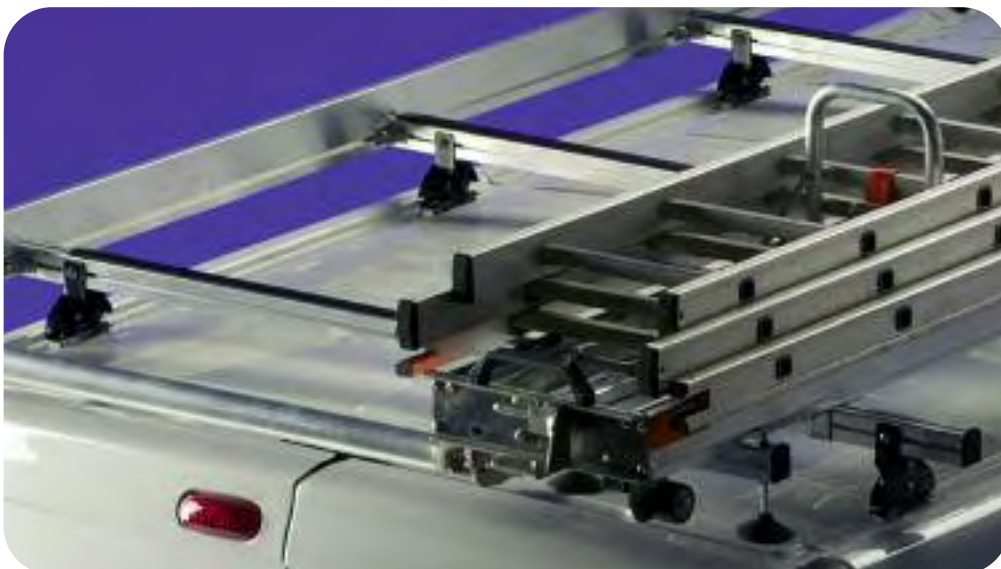

STORE VAN also boasts the rare **GS** certification for the universal ladder rack.

## Store Van

A TRADEMARK OF FAMI'S GROUP

Fami's constant focus on the market trends, combined with studies for customized products, has been the winning strategy also for the last born brand name – STORE VAN - which offers fittings for commercial vehicles of all types. The accurate designed modules and the perfect adaptability for the most different personalised projects, confirmed the quality and supremacy of Store Van's components.

The achieved success allowed Store Van to become one of the most reliable and popular supplier among the international commercial vehicles producers.



PROFESSIONALITÀ IN MOVIMENTO

Store Van first introduced an innovative installation system without drilling the van bodyworks to fix the equipments, guaranteeing functionality, quality, steadiness and aesthetic features, both for estate cars and for large vans and fleets.

## LOGISTIC QUALITY SYSTEMS

Fami's strategy develops through products versatility, while each project becomes exclusive and customised. This strategy, along with advanced industrial processes, originates fitting systems suitable to meet all customers' requirements.

Fami, one of the leading Company in the field of industrial storage systems, gives priority to the technological features but also considers the design and the "soul" of the product, signing each article with a perfect balance of technology and "heart".

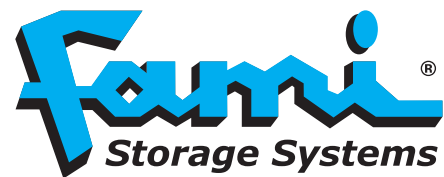

Fami stands out for its high technology and original solutions, like industrial storage, work stations and conductive systems for the electronic industry. All Company's advanced solutions can be employed and diversified in different applications, becoming Fami the leading Company in its field as far competence and competitiveness.



	MODEL	VEHICLE DATA	PAGE
	<b>Combo Panel Van</b>	<b>2,7 m<sup>3</sup></b> L1 H1 wheelbase 2716 mm height 1801 mm	<b>15-18</b>
	<b>Vivaro Panel Van SWB Standard roof</b>	<b>5 m<sup>3</sup></b> L1 H1 wheelbase 3098 mm height 1960 mm	<b>23-26</b>
	<b>Vivaro Panel Van SWB High roof</b>	<b>7,1 m<sup>3</sup></b> L1 H2 wheelbase 3098 mm height 2492 mm	<b>27-30</b>
	<b>Vivaro Panel Van LWB Standard roof</b>	<b>5,9 m<sup>3</sup></b> L2 H1 wheelbase 3498 mm height 1960 mm	<b>31-34</b>
	<b>Vivaro Panel Van LWB High roof</b>	<b>8,4 m<sup>3</sup></b> L2 H2 wheelbase 3498 mm height 2492 mm	<b>35-38</b>
	<b>Movano Panel Van SWB Standard roof</b>	<b>8 m<sup>3</sup></b> L1 H1 wheelbase 3078 mm height 2253 mm	<b>43-46</b>
	<b>Movano Panel Van SWB High roof</b>	<b>9,1 m<sup>3</sup></b> L1 H2 wheelbase 3078 mm height 2496 mm	<b>47-50</b>
	<b>Movano Panel Van MWB High roof</b>	<b>10,8 m<sup>3</sup></b> L2 H2 wheelbase 3578 mm height 2493 mm	<b>51-54</b>
	<b>Movano Panel Van MWB Maxi roof</b>	<b>12 m<sup>3</sup></b> L2 H3 wheelbase 3578 mm height 2721 mm	<b>55-58</b>
	<b>Movano Panel Van LWB High roof</b>	<b>12,6 m<sup>3</sup></b> L3 H2 wheelbase 4078 mm height 2490 mm	<b>59-62</b>
	<b>Movano Panel Van LWB Maxi roof</b>	<b>13,9 m<sup>3</sup></b> L3 H3 wheelbase 4078 mm height 2720 mm	<b>63-66</b>



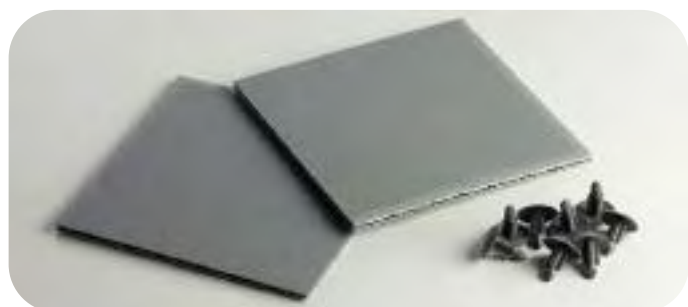

## LININGS

**4** mm thick polypropylene honeycomb linings with scratchproof surface. Lightweight and robust.



## FLOORINGS

**P**re-shaped loading floors in one or more jointed pieces with extruded aluminium inserts. Made of 12 mm thick birch and conifer phenolic multi-ply, resin-bonded on both faces and a wear-resistant and slip-proof surface treatment.



## DRAWERS

**E**asy and intuitive one hand opening with handle operated opening and closing safety stop. Wide range of dividing options of the drawers by means of plastic or metal accessories.

**Load capacity:** 50 Kg



## RETRACTABLE SHELVES

**R**etractable shelves for one or two tool cases with the possibility of introducing tool cases with different heights and depths.

**Load capacity:** 50 Kg



## VICE WORKBENCHES

**R**etractable vice workbench complete with steel vice, swivel base, jaws width 100 mm.



## Technical features

**TALENTO** ladder rack rails  
with **lowering system** with brake for lad-  
ders weight up to 60 kg.



**ALADIN** ladder rack rails  
with **servo-assisted lowering and lifting system** for ladders weight up to 60 kg.





## LOADING RAMPS



Servo assisted loading ramps with tubular steel structure and knurled slip-proof aluminium platform. Connection to the vehicle by means of a telescopic column and self-positioning feet.

**Load capacity from:** 600 to 1500 Kg.



## 292 mm DEEP TOOL CASES

**Order no. VAL 001****Case with boxes**

Dim. 438x292x67 mm (WxDxH)  
Internal solutions with:  
2 green, 2 blue, 5 yellow,  
10 red boxes.

**Order no. VAL 002****Case with boxes**

Dim. 438x292x67 mm (WxDxH)  
Internal solutions with: 8 blue,  
8 red boxes.

**Order no. VAL 003****Case with boxes**

Dim. 438x292x102 mm (WxDxH)  
Internal solutions with: 2 blue,  
2 green, 5 yellow, 10 red boxes.  
Upper tray with 20 red and 10  
yellow boxes.

**Order no. VAL 004****Case with boxes**

Dim. 438x292x102 mm (WxDxH)  
Internal solutions with:  
4 green, 4 blue boxes.  
Upper tray with 20 red and  
10 yellow boxes.

## 343 mm DEEP TOOL CASES

**Order no. VAL 005****Case with boxes**

Dim. 438x343x67 mm (WxDxH)  
Internal solutions with:  
2 green, 3 blue, 6 yellow,  
12 red boxes.

**Order no. VAL 006****Case with boxes**

Dim. 438x343x67 mm (WxDxH)  
Internal solutions with:  
8 green boxes.

**Order no. VAL 007****Case with boxes**

Dim. 438x343x102 mm (WxDxH)  
Internal solutions with:  
2 green, 3 blue, 6 yellow, 12 red  
boxes.  
Upper tray with 24 red and 12  
yellow boxes.

**Order no. VAL 008****Case with boxes**

Dim. 438x343x102 mm (WxDxH)  
Internal solutions with:  
12 blue boxes.  
Upper tray with 24 red and 12  
yellow boxes.



## ACCESSORIES FOR MODULES



**Order no. ACS 001**  
Hand washing kit



**Order no. ACS 002**  
Can holder kit with 20  
litres capacity metal can



**Order no. ACS 003**  
Supports with belt  
strap for gas cylinders  
and extinguishers



**Order no. ACS 004**  
First aid kit



**Order no. ACS 005**  
Paper towel holder kit  
with paper towel  
Ø 140 mm



**Order no. ACS 006**  
DIN A4 document  
holder



**Order no. ACS 007**  
Spray-can holder kit



**Order no. ACS 008**  
Painted aluminium  
cable saddles

## LOAD RETAINING BARS AND BELTS



Load retaining bar kit available in 3 dimensions:

**Order no. ACS 009**  
Load retaining bar length 1000 mm  
Pair of polyester belts length 3260 mm

**Order no. ACS 010**  
Load retaining bar length 1500 mm  
Pair of polyester belts length 3260 mm

**Order no. ACS 011**  
Load retaining bar length 2000 mm  
Pair of polyester belts length 3260 mm

## CRANES



**R**evolving crane with positioning brake and folding arm. Including 12 V motor and lifting hook sliding on an aluminium guide and electric limit switch, equipped with remote control with cable.

**Load capacity from:** 150 to 190 Kg.

**OPTIONAL ACCESSORY NOT AVAILABLE FOR ALL VEHICLES MODELS**

## COMPRESSORS AND RETRACTABLE HORIZONTAL SYSTEMS



**R**etractable horizontal aluminium frames. Mechanical stop of the frame in opening and closing.

Possibility of blocking the shelf in any opening position.

**Load capacity:** 300 Kg.

**Extraction:** 60 %

**V**ertical compressors 220V - 380V.

**Capacity:** 50 - 100 LT





## COLLAPSIBLE VICE WORKBENCHES



**C**ollapsible vice workbenches with floor support.

Work bench height adjustable.

**Top width:** 240 / 340 mm

**Depth:** 1150 mm



## LIFTING DOORS



**L**ifting doors with assisted opening.

**Length:** 508 / 717 / 1016 / 1225 / 1524 mm

**Useful height:** 350 / 400 mm



## SHELVES



**S**helves available for modules:

**Length:** 508 / 717 / 1016 / 1225 / 1524 mm

**Depth:** 265 / 365 mm

**Front height:** 35 mm

**Back height:** 100 mm

Available with or without polypropylene containers

# Strategically strong



## Combo L1 H1 - 2,7 m<sup>3</sup>

### Vehicle equipped with:

1	ord. no. POS 211	roof rack
1	ord. no. PIL 212	wooden flooring
1	ord. no. MDL 010	module
1	ord. no. MDL 007	module
1	ord. no. ACS 007	spray cans holder kit
1	ord. no. ACS 004	first aid kit
1	ord. no. ACS 003	support with belt for gas cylinders and extinguishers (extinguisher not supplied)

- › **FAST ASSEMBLY**
- › **TOTAL MODULARITY**
- › **SAFETY SOUND ABSORBING ELEMENTS BETWEEN THE VARIOUS METAL COMPONENTS**
- › **ERGONOMETRIC SHAPES**
- › **HEIGHT ADJUSTMENT IN PITCH OF 25 mm OF THE VARIOUS ELEMENTS**





# COMBO



## FLOORINGS AND LININGS

for COMBO with RH side sliding door and rear leaf doors, sheet metal side walls

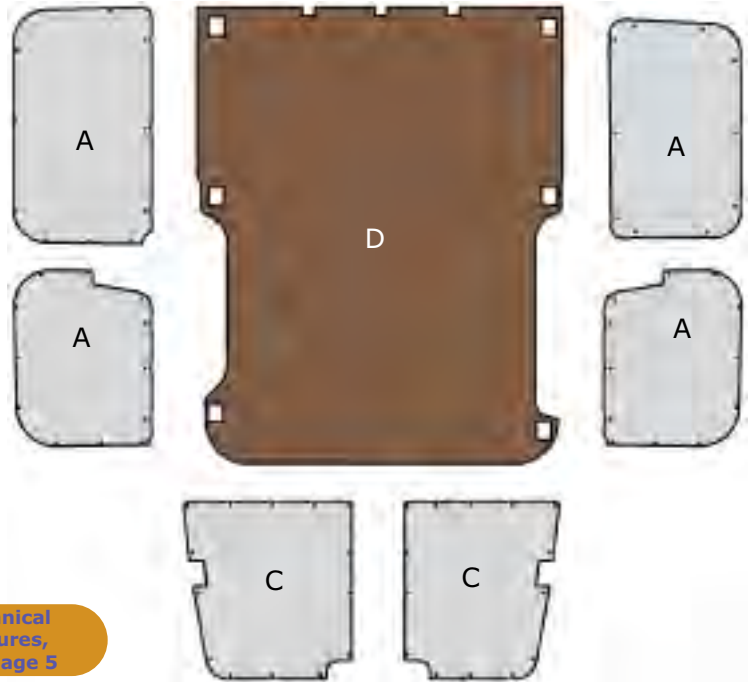
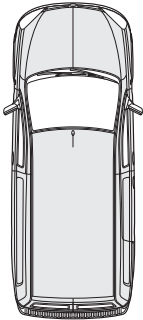

### **A** Polypropylene linings Order no. PAN 209

Weight: **3,18 Kg**

**Polypropylene linings for:**

- LH side wall
- RH side wall and sliding door

Technical  
features,  
see page 5

### **C** Polypropylene linings Order no. PAR 207

Weight: **1,29 Kg**

**Polypropylene linings for:**

- upper section of rear leaf doors

### **D** Flooring for sheet steel and mesh bulkhead (1) Order no. PIL 212

Weight: **16,80 Kg**

**12 mm thick wooden flooring phenolic** and predrilling for lashing hook supports.

## ROOF RACK



**ROOF RACK** only for Combo with rear leaf doors

### Order no. POT 211

Dimensions: **2000x1400 mm** (WxD)

Weight: **21,05 Kg**

**Roof rack** complete with:

- 2 aluminium crossmembers with fixing connectors and rubber profile
- 1 additional crossmember with supports
- 2 2000 mm long aluminium side upstands
- 1 aluminium loading roller

Supplied with **stainless steel** screws for fixing.

**Load capacity: 78 Kg (p.u.d.)**

Technical  
features,  
see page 5

## LADDER RACK

The ladder rack rail can be mounted on the right or on the left hand side of the vehicle



**LADDER RACK** only for Combo with rear leaf doors

### Order no. POS 211

Dimensions: **2110x1380 mm** (WxD)

Weight: **42,60 Kg**

**Ladder rack** complete with:

- 2 aluminium crossmembers with fixing connectors and rubber profile
- 1 additional crossmember with supports
- 1 2000 mm long aluminium side upstands
- 1 aluminium loading roller
- 1 ladder rack rail made from stainless steel and aluminium **TALENTO series**, length 2110 mm

Supplied with **stainless steel** screws for fixing.

**Load capacity: 57 Kg (p.u.d.)**





Technical features,  
see page 5

Accessories  
see page 9

\*approximate  
measurement

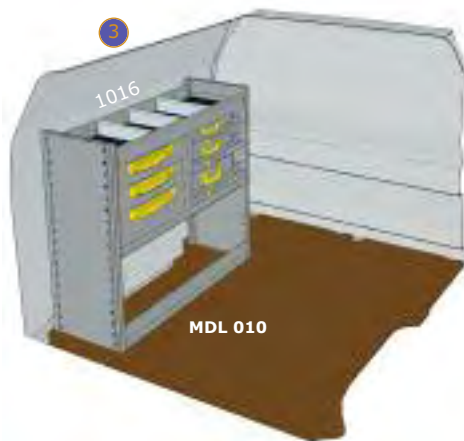
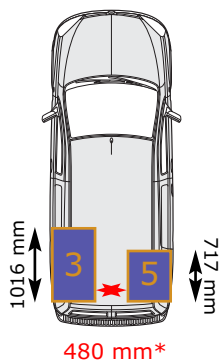

Layout example of LH side



Layout example of RH side



Suitable to be installed in the zone: **3**

**Order no. MDL 008**

Dimensions: **1016x365x900 mm** (WxDxH)

Weight: **41,7 Kg**

Module complete with:

- 1 tray with rubber and 3 adjustable dividers
- 2 drawers
- 1 shelf with door
- 1 hinged door



Suitable to be installed in the zone: **3**

**Order no. MDL 009**

Dimensions: **1016x365x900 mm** (WxDxH)

Weight: **25,4 Kg**

Module complete with:

- 3 trays with rubber and 9 adjustable dividers



Suitable to be installed in the zone: **3**

**Order no. MDL 010**

Dimensions: **1016x365x900 mm** (WxDxH)

Weight: **60,1 Kg**

Module complete with:

- 1 tray with rubber and 3 adjustable dividers
- 3 drawers
- 3 retractable shelves for tool cases complete with tool cases and boxes



Suitable to be installed in the zone: **5**

**Order no. MDL 005**

Dimensions: **717x365x900 mm** (WxDxH)

Weight: **32,9 Kg**

Module complete with:

- 1 tray with rubber and 2 adjustable dividers
- 2 drawers
- 1 shelf with door



Suitable to be installed in the zone: **5**

**Order no. MDL 006**

Dimensions: **717x365x900 mm** (WxDxH)

Weight: **22,7 Kg**

Module complete with:

- 3 trays with rubber and 6 adjustable dividers



Suitable to be installed in the zone: **5**

**Order no. MDL 007**

Dimensions: **717x365x900 mm** (WxDxH)

Weight: **42,7 Kg**

Module complete with:

- 3 trays with rubber and 6 adjustable dividers
- 1 retractable vice workbench complete with steel vice with 100 mm jaws and 1/2" to 1 1/2" pipe clamp



## DOUBLE LEVEL FLOOR



Load capacity of each drawer:  
**150 Kg**

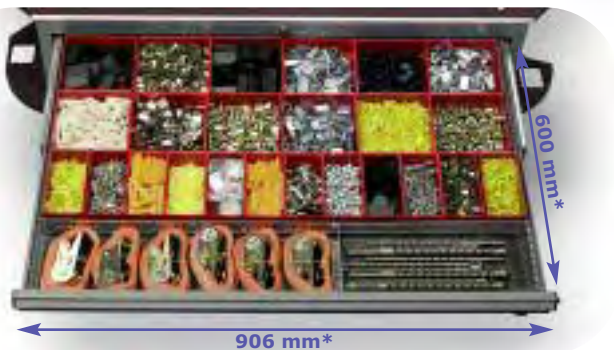

Detail of the drawer with a useful height of 54 mm supplied as standard with: 1 non-slotted divider, 24 divider trays.  
Tools not included.



Detail of the drawer with a useful height of 104 mm supplied as standard with: 1 slotted divider, 1 transversal divider.  
Tools not included

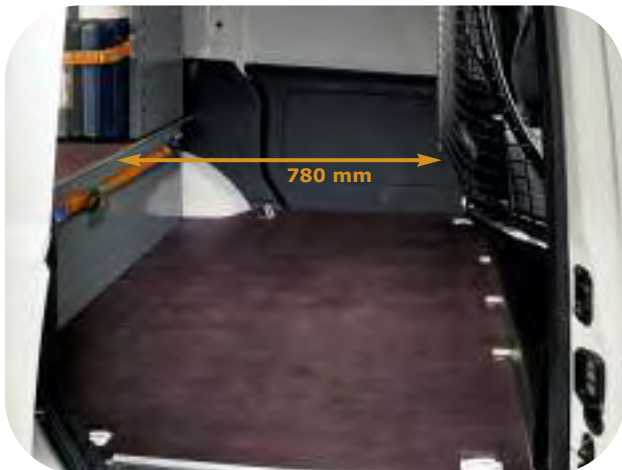

Detail of the load retaining belt with lashing hooks supports in standard series with double level floor kit.

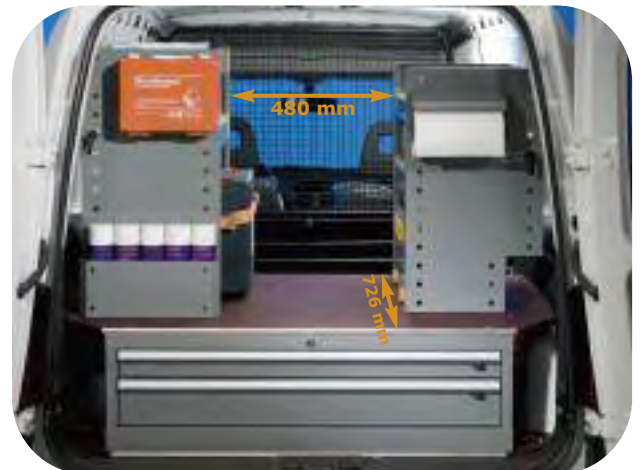

Detail of the double level floor kit with two rear modules



**1 Double level floor kit for sheet steel and mesh bulkhead (1)**  
**Order no. MPR 204**

Dimensions: **1645x1316x324 mm** (WxDxH)

Weight: **99,73 Kg**

Kit complete with:

- 1 12 mm thick **lower** wooden flooring phenolic coated **for sheet steel and mesh bulkhead**
- 1 12 mm thick **upper** wooden flooring phenolic coated
- 1 drawer cabinet with 2 drawers complete of partitioning material, internal dimensions of the drawer 906x600x54/104 mm h

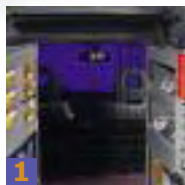

**2 Module**  
**Order no. MDL 057**

Dimensions: **508x365x700 mm** (WxDxH)

Weight: **15,40 Kg**

Module complete with:

- 1 tray with rubber and 1 adjustable divider
- 1 shelf for tool case complete with tool case and boxes
- 1 connection bar with fixing belts for tool cases



**3 Module**  
**Order no. MDL 058**

Dimensions: **508x365x650 mm** (WxDxH)

Weight: **21,60 Kg**

Module complete with:

- 1 tray with rubber and 1 adjustable divider
- 2 shelves for tool cases complete with tool cases and boxes
- 1 hinged door

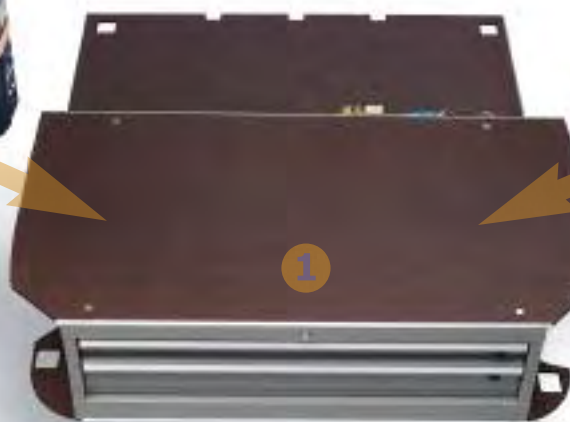

**4 Module**  
**Order no. MDL 059**

Dimensions: **508x365x700 mm** (WxDxH)

Weight: **13,35 Kg**

Module complete with:

- 2 trays with rubber and 2 adjustable dividers
- 1 connection bar with fixing belts for tool cases



**5 Module**  
**Order no. MDL 060**

Dimensions: **508x365x650 mm** (WxDxH)

Weight: **13,60 Kg**

Module complete with:

- 2 trays with rubber and 2 adjustable dividers
- 1 hinged door

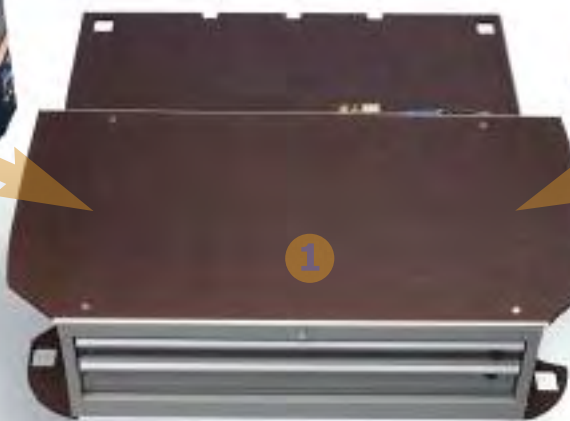



# Strategically strong



## VIVARO L2 H1 - 5,9 m<sup>3</sup>

### Vehicle equipped with:

- 1 ord. no. POS 205 ladder rack (ladder not supplied)
- 1 ord. no. PIL 207 wooden flooring
- 1 ord. no. PAN 204 polypropylene lining
- 1 ord. no. PAR 202 polypropylene lining
- 1 ord. no. MDL 008 module
- 1 ord. no. MDL 010 module
- 1 ord. no. MDL 012 module
- 1 ord. no. MDL 038 module
- 1 ord. no. SFM 300 fixing bar
- 1 ord. no. ACS 004 first aid kit
- 2 ord. no. ACS 007 spray cans holder kit
- 1 ord. no. ACS 005 paper roll holder with paper roll
- 1 ord. no. ACS 003 support with belt for gas cylinders and extinguishers (extinguisher not supplied)

- > **FAST ASSEMBLY**
- > **TOTAL MODULARITY**
- > **SAFETY SOUND ABSORBING ELEMENTS BETWEEN THE VARIOUS METAL COMPONENTS**
- > **ERGONOMETRIC SHAPES**
- > **HEIGHT ADJUSTMENT IN PITCH OF 25 mm OF THE VARIOUS ELEMENTS**



# VIVARO











**FLOORINGS AND LININGS**  
for VIVARO with RH side sliding  
door and rear leaf doors, sheet  
metal side walls

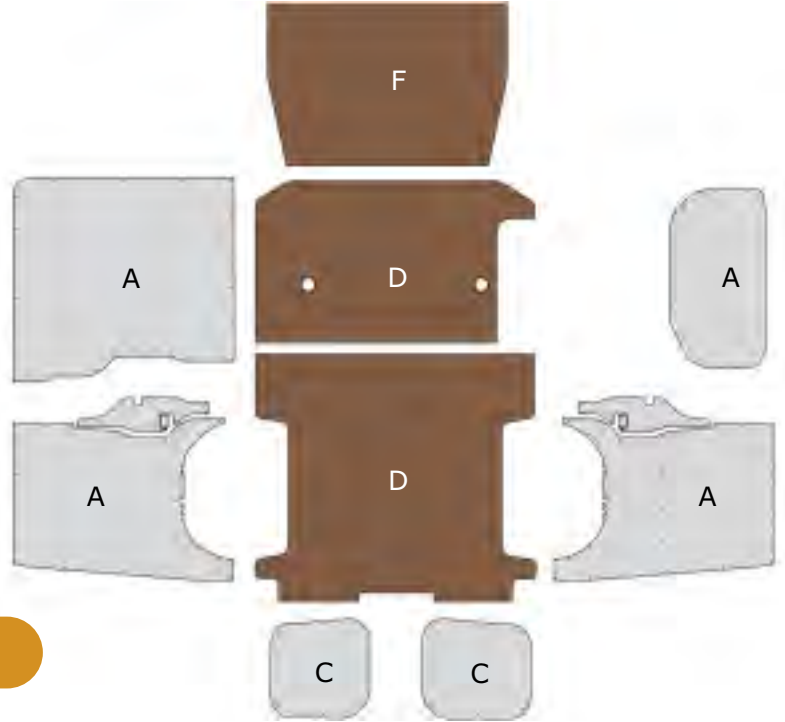

**A Polypropylene linings**  
Order no. PAN 203

Weight: **7,67 Kg**  
Polypropylene linings for:  
- LH side wall  
- RH side wall and sliding door

Technical features,  
see page 5

**C Polypropylene linings**  
Order no. PAR 202

Weight: **1,33 Kg**  
Polypropylene linings for:  
- upper section of rear leaf doors

**D Flooring**  
Order no. PIL 205

Weight: **29,35 Kg**  
12 mm thick wooden flooring phenolic coated and predrilling for lashing hook supports.

**F Bulkhead**  
Order no. PIR 201

Weight: **10,60 Kg**  
12 mm wooden phenolic coated bulkhead panel.

**FLOORINGS AND LININGS**  
for VIVARO with RH side sliding  
door and lower lift door, sheet  
metal side walls

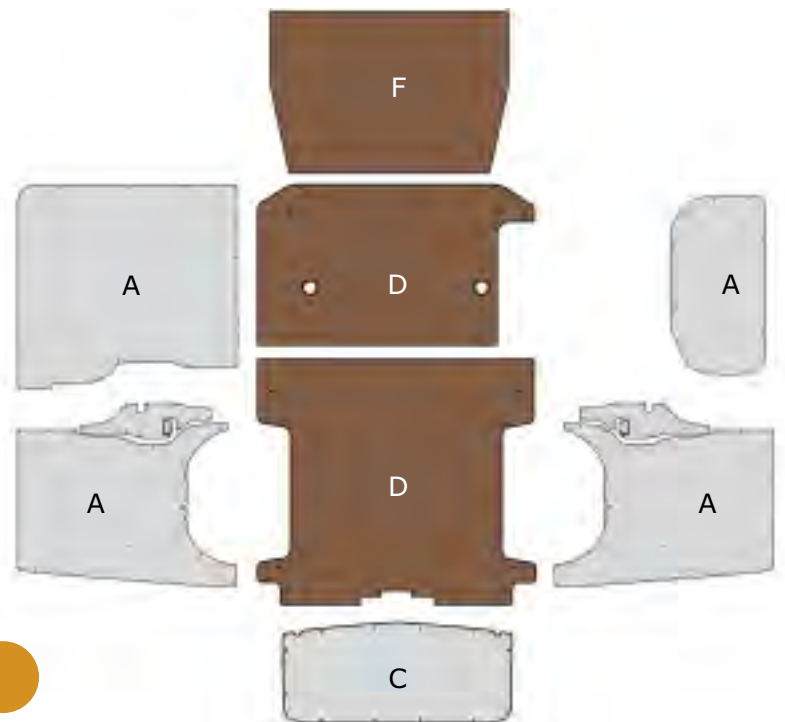
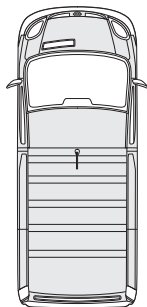

**A Polypropylene linings**  
Order no. PAN 203

Weight: **7,67 Kg**  
Polypropylene linings for:  
- LH side wall  
- RH side wall and sliding door

Technical features,  
see page 5

**C Polypropylene linings**  
Order no. PAR 203

Weight: **1,42 Kg**  
Polypropylene linings for:  
- upper part of sheet metal lift door

**D Flooring**  
Order no. PIL 206

Weight: **29,35 Kg**  
12 mm thick wooden flooring phenolic coated and predrilling for lashing hook supports.

**F Bulkhead**  
Order no. PIR 201

Weight: **10,60 Kg**  
12 mm wooden phenolic coated bulkhead panel.

5 m<sup>3</sup>  
L1 H1 wheelbase 3098 mm

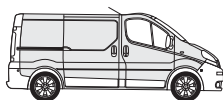

VIVARO Panel Van SWB  
Standard roof

### ROOF RACK only for VIVARO with rear leaf doors



#### Order no. POT 203

Dimensions: **2750x1700 mm** (WxD)  
Weight: **30,42 Kg**

#### Roof rack complete with:

- 4 aluminium crossmembers with fixing connectors and rubber profile
- 2 2750 mm long aluminium side upstands
- 1 aluminium loading roller

Supplied with **stainless steel** screws for fixing.

**Load capacity: 169 Kg (p.u.d.)**



### LADDER RACK only for VIVARO with rear leaf doors



The ladder rack rail can be mounted on the right or on the left hand side of the vehicle

#### Order no. POS 203

Dimensions: **2750x1680 mm** (WxD)  
Weight: **54,83 Kg**

#### Ladder rack complete with:

- 4 aluminium crossmembers with fixing connectors and rubber profile
- 1 2750 mm long aluminium side upstand
- 1 aluminium loading roller
- 1 ladder rack rail made from stainless steel and aluminium **TALENTO** series, length 2650 mm
- 1 aluminium connection crossmember

Supplied with **stainless steel** screws for fixing.

**Load capacity: 145 Kg (p.u.d.)**



Technical  
features,  
see page 7

### READY SOLUTIONS



#### Order no. MDL S01

Dimensions: **1733x365x1200 mm** (WxDxH). Weight: **43,25 Kg**

Module complete with:

- 3 trays with rubber and 15 adjustable dividers
- 1 fixing bar length 2500 mm

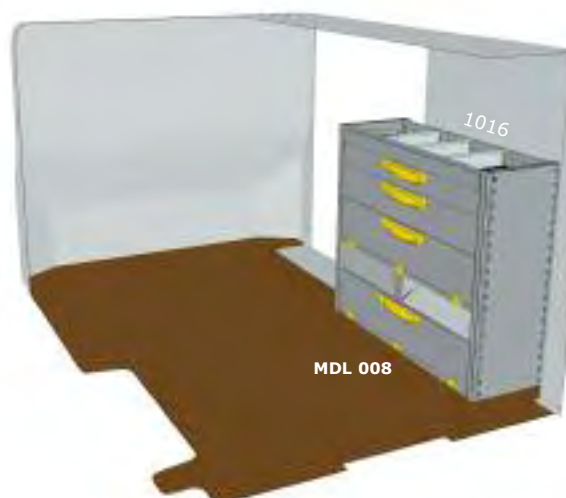

#### Order no. MDL 008

Dimensions: **1016x365x900 mm** (WxDxH). Weight: **41,7 Kg**

Module complete with:

- 1 tray with rubber and 3 adjustable dividers
- 2 drawers
- 1 shelf with door
- 1 hinged door



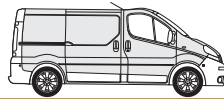

MODULES 717 mm



Suitable to be installed in the zone: **5**

**Order no. MDL 007**

Dimensions: **717x365x900 mm** (WxDxH)

Weight: **42,7 Kg**

Module complete with:

- 3 trays with rubber and 6 adjustable dividers
- 1 retractable vice workbench complete with steel vice with 100 mm jaws and 1/2" to 1 1/2" pipe clamp



Suitable to be installed in the zone: **2**

**Order no. MDL 011**

Dimensions: **717x365x900 mm** (WxDxH)

Weight: **20 Kg**

Module complete with:

- 1 tray with rubber and 2 adjustable dividers
- 1 shelf with door
- 1 connection bar with fixing belts for tool cases

MODULES 1016 mm



Suitable to be installed in the zone: **3 5**

**Order no. MDL 008**

Dimensions: **1016x365x900 mm** (WxDxH)

Weight: **41,7 Kg**

Module complete with:

- 1 tray with rubber and 3 adjustable dividers
- 2 drawers
- 1 shelf with door
- 1 hinged door



Suitable to be installed in the zone: **3 5**

**Order no. MDL 009**

Dimensions: **1016x365x900 mm** (WxDxH)

Weight: **25,4 Kg**

Module complete with:

- 3 trays with rubber and 9 adjustable dividers

Technical features, see page 5  
Accessories see page 9

\*approximate measurement

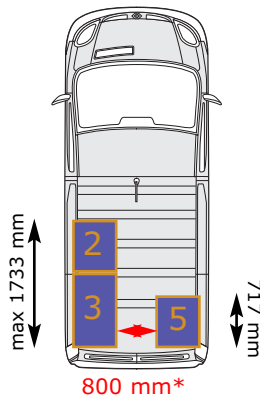

Suitable to be installed in the zone: **3 5**

**Order no. MDL 010**

Dimensions: **1016x365x900 mm** (WxDxH)

Weight: **60,1 Kg**

Module complete with:

- 1 tray with rubber and 3 adjustable dividers
- 3 drawers
- 3 retractable shelves for tool cases complete with tool cases and boxes

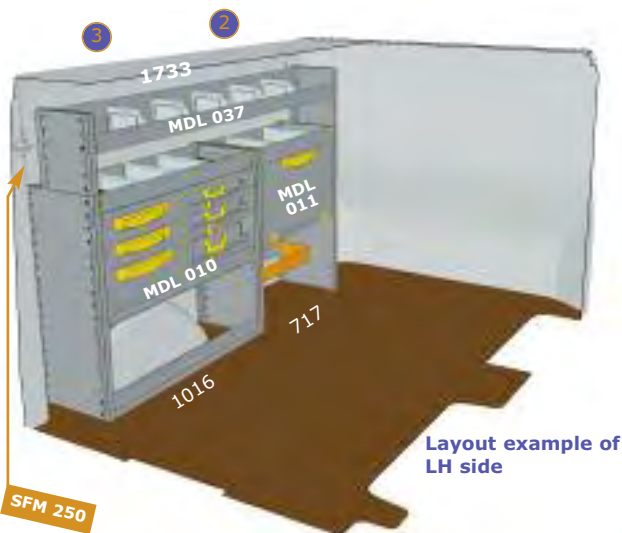

Layout example of LH side

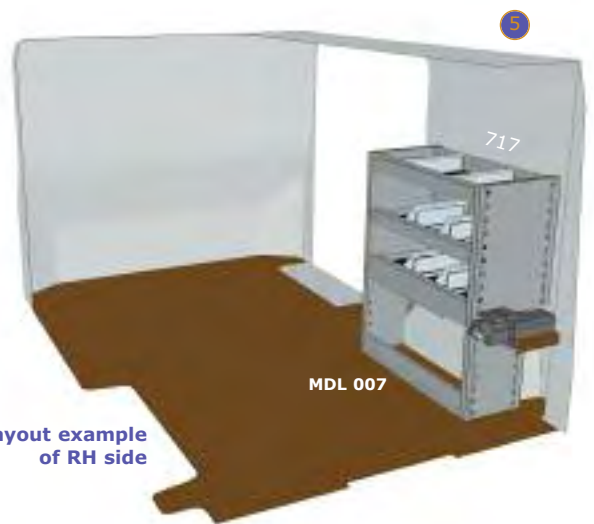

Layout example of RH side

SFM 250

5 m<sup>3</sup>  
L1 H1 wheelbase 3098 mm

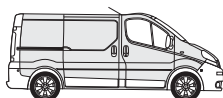

VIVARO Panel Van SWB  
Standard roof

### ADD-ON MODULE 1733 MM



x1



x2

x1

Suitable to be installed in the zone: **2** + **3**

#### Order no. MDL 037

Dimensions: **1733x265x300 mm** (WxDxH)

Weight: **10,80 Kg**

Module complete with:

- 1 tray with rubber and 5 adjustable dividers

#### Order no. SFM 250

Fixing bar: **2500x30x35 mm** (WxDxH)

Weight: **2,2 Kg**

Fixing bar for upper modules, complete with brackets, bolts and screws.

**The bar is necessary to fix the additional MDL 037 module to the vehicle.**

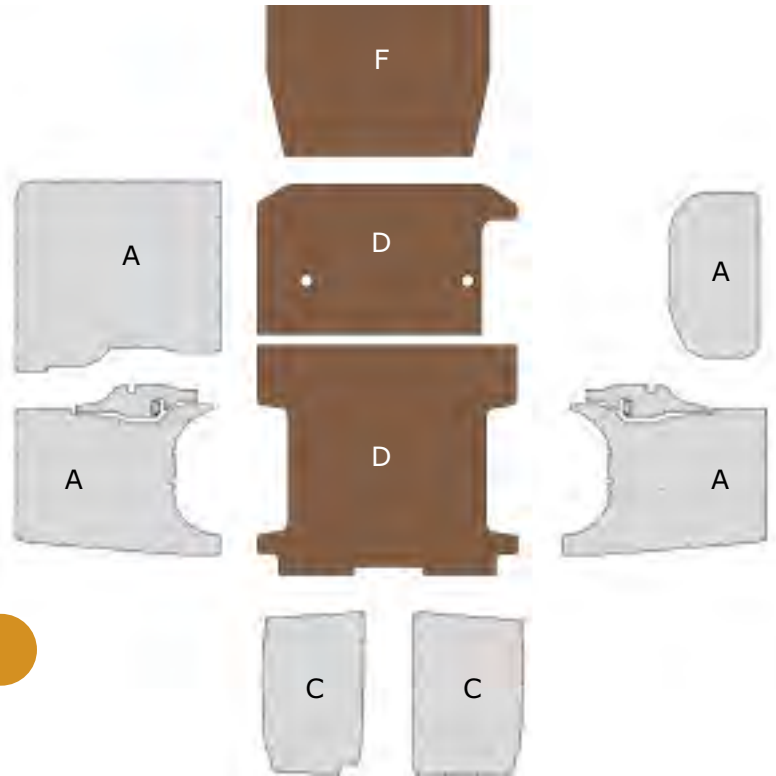
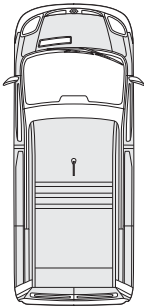

**FLOORINGS AND LININGS**  
 for VIVARO with RH side sliding  
 door and rear leaf doors, sheet  
 metal side walls

**A Polypropylene linings**  
**Order no. PAN 203**

 Weight: **7,67 Kg**
**Polypropylene linings for:**

- LH side wall
- RH side wall and sliding door

 Technical  
 features,  
 see page 5

**C Polypropylene linings**  
**Order no. PAR 204**

 Weight: **2,45 Kg**
**Polypropylene linings for:**

- upper section of rear leaf doors

**D Flooring**  
**Order no. PIL 205**

 Weight: **29,35 Kg**
**12 mm thick wooden flooring phenolic**
**coated and predrilling for lashing hook supports.**
**F Bulkhead**  
**Order no. PIR 201**

 Weight: **10,60 Kg**
**12 mm wooden phenolic coated**
**bulkhead panel.**
**ROOF RACK**

**Order no. POT 204**

 Dimensions: **2500x1600 mm (WxD)**

 Weight: **28,74 Kg**
**Roof rack complete with:**

- 4 aluminium crossmembers with fixing connectors and rubber profile
- 2 2500 mm long aluminium side upstands
- 1 aluminium loading roller

 Supplied with **stainless steel** screws for fixing.

**Load capacity: 171 Kg (p.u.d.)**

 Technical  
 features,  
 see page 7

**LADDER RACK**

 The ladder rack rail can be  
 mounted on the right or on the left  
 hand side of the vehicle

**Order no. POS 204**

 Dimensions: **2650x1580 mm (WxD)**

 Weight: **57,94 Kg**
**Ladder rack complete with:**

- 4 aluminium crossmembers with fixing connectors and rubber profile
- 1 2500 mm long aluminium side upstand
- 1 aluminium loading roller
- 1 ladder rack rail made from stainless steel and aluminium **ALADIN** series, length 2650 mm

 Supplied with **stainless steel** screws for fixing.

**Load capacity: 142 Kg (p.u.d.)**



7,1 m<sup>3</sup>  
L1 H2 wheelbase 3098 mm



VIVARO Panel Van SWB  
High roof

## READY SOLUTIONS



MDL 029

### Order no. MDL 029

Dimensions: **1733x365x1200 mm** (WxDxH). Weight: **42,05 Kg**  
Module complete with:  
3 trays with rubber and 15 adjustable dividers



MDL 014

### Order no. MDL 014

Dimensions: **1016x365x1200 mm** (WxDxH). Weight: **49,4 Kg**  
Module complete with:  
2 trays with rubber and 6 adjustable dividers  
2 drawers  
1 shelf with door  
1 hinged door





MODULES 717 mm

MODULES 1016 mm



Suitable to be installed in the zone: **5**

**Order no. MDL 007**

Dimensions: **717x365x900 mm** (WxDxH)

Weight: **42,7 Kg**

Module complete with:

- 3 trays with rubber and 6 adjustable dividers
- 1 retractable vice workbench complete with steel vice with 100 mm jaws and 1/2" to 1 1/2" pipe clamp



Suitable to be installed in the zone: **3 5**

**Order no. MDL 014**

Dimensions: **1016x365x1200 mm** (WxDxH)

Weight: **49,4 Kg**

Module complete with:

- 2 trays with rubber and 6 adjustable dividers
- 2 drawers
- 1 shelf with door
- 1 hinged door



Suitable to be installed in the zone: **3 5**

**Order no. MDL 015**

Dimensions: **1016x365x1200 mm** (WxDxH)

Weight: **48,3 Kg**

Module complete with:

- 3 trays with rubber and 9 adjustable dividers
- 1 drawer
- 1 retractable shelf for tool cases complete with tool cases and boxes



Suitable to be installed in the zone: **2**

**Order no. MDL 119**

Dimensions: **717x365x1700 mm** (WxDxH)

Weight: **38,10 Kg**

Module complete with:

- 4 trays with rubber and 8 adjustable dividers
- 1 shelf with door
- 1 connection bar with fixing belts for tool cases

\*approximate measurement

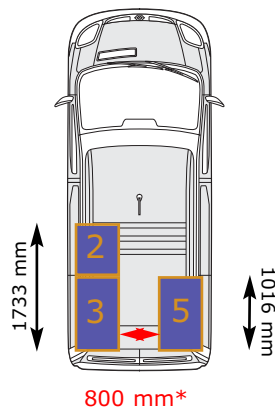

Suitable to be installed in the zone: **3 5**

**Order no. MDL 016**

Dimensions: **1016x365x1200 mm** (WxDxH)

Weight: **33,2 Kg**

Module complete with:

- 4 trays with rubber and 12 adjustable dividers

Technical features, see page 5  
Accessories see page 9



Layout example of LH side



Layout example of RH side

SFM 250



MODULES 1016 mm



Suitable to be installed in the zone: **3 5**

**Order no. MDL 161**

Dimensions: **1016x365x1700 mm** (WxDxH)

Weight: **61,38 Kg**

Module complete with:

- 4 trays with rubber and 12 adjustable dividers
- 2 drawers
- 1 shelf with door
- 1 hinged door

Suitable to be installed in the zone: **3 5**

**Order no. MDL 162**

Dimensions: **1016x365x1700 mm** (WxDxH)

Weight: **58,07 Kg**

Module complete with:

- 5 trays with rubber and 15 adjustable dividers
- 1 drawer
- 1 retractable shelf for tool cases complete with tool cases and boxes

Suitable to be installed in the zone: **3 5**

**Order no. MDL 163**

Dimensions: **1016x365x1700 mm** (WxDxH)

Weight: **40,20 Kg**

Module complete with:

- 6 trays with rubber and 18 adjustable dividers

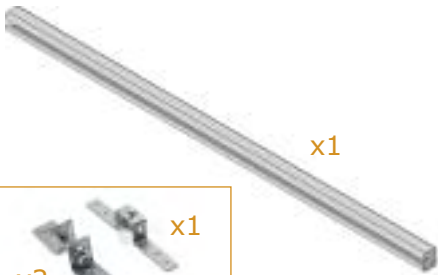

x1

x1

x2

**Order no. SFM 250**

Fixing bar: **2500x30x35 mm** (WxDxH)

Weight: **2,2 Kg**

Fixing bar for modules, complete with brackets, bolts and screws.

**The bar is necessary to fix the modules to the vehicle.**

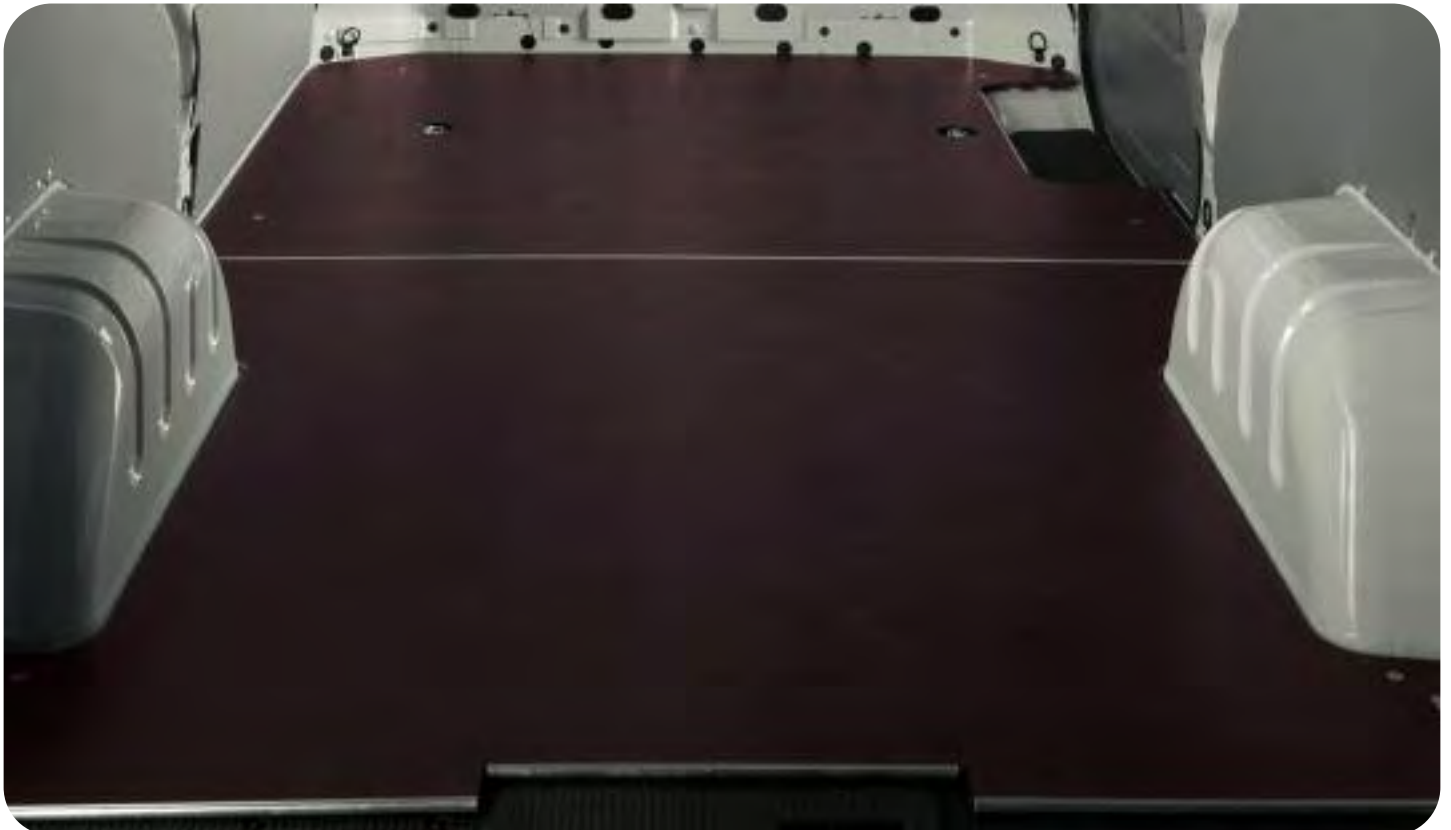



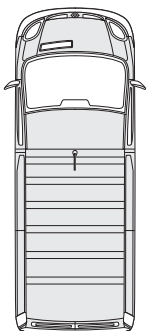
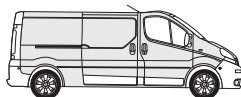

### FLOORINGS AND LININGS

for VIVARO with RH side sliding door and rear leaf doors, sheet metal side walls

Technical features, see page 5

#### A Polypropylene linings

Order no. PAN 204

Weight: 9,61 Kg

Polypropylene linings for:

- LH side wall
- RH side wall and sliding door

#### C Polypropylene linings

Order no. PAR 202

Weight: 1,33 Kg

Polypropylene linings for:

- upper section of rear leaf doors

#### D Flooring

Order no. PIL 207

Weight: 34,85 Kg

12 mm thick wooden flooring phenolic coated and predrilling for lashing hook supports.

#### F Bulkhead

Order no. PIR 201

Weight: 10,60 Kg

12 mm wooden phenolic coated bulkhead panel.

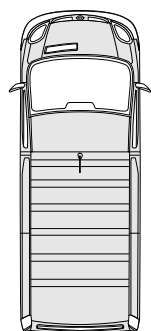
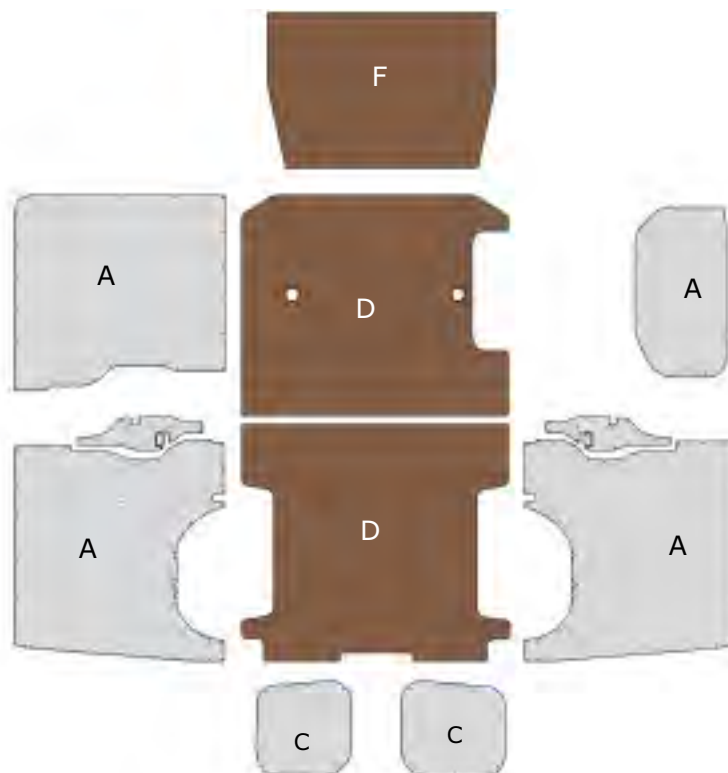

### FLOORINGS AND LININGS

for VIVARO with RH side sliding door and lower lift door, sheet metal side walls

Technical features, see page 5

#### A Polypropylene linings

Order no. PAN 204

Weight: 9,61 Kg

Polypropylene linings for:

- LH side wall
- RH side wall and sliding door

#### C Polypropylene linings

Order no. PAR 203

Weight: 1,42 Kg

Polypropylene linings for:

- upper part of sheet metal lift door

#### D Flooring

Order no. PIL 208

Weight: 34,85 Kg

12 mm thick wooden flooring phenolic coated and predrilling for lashing hook supports.

#### F Bulkhead

Order no. PIR 201

Weight: 10,60 Kg

12 mm wooden phenolic coated bulkhead panel.

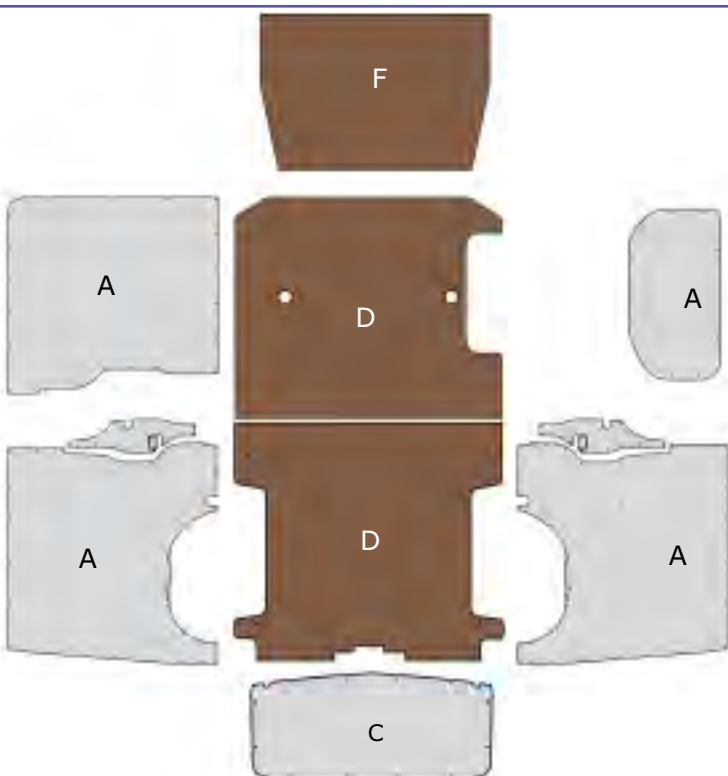

5,9 m<sup>3</sup>  
L2 H1 wheelbase 3498 mm

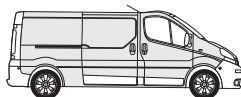

VIVARO Panel Van LWB  
Standard roof

### ROOF RACK only for VIVARO with rear leaf doors

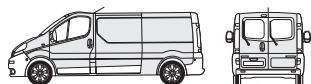

### Order no. POT 205

Dimensions: **3000x1700 mm** (WxD)  
Weight: **32,26 Kg**

**Roof rack** complete with:

- 4 aluminium crossmembers with fixing connectors and rubber profile
- 2 3000 mm long aluminium side upstands
- 1 aluminium loading roller

Supplied with **stainless steel** screws for fixing.

**Load capacity: 168 Kg (p.u.d.)**

Technical  
features,  
see page 7

### LADDER RACK only for VIVARO with rear leaf doors



The ladder rack rail can be mounted on the right or on the left hand side of the vehicle



### Order no. POS 205

Dimensions: **3240x1680 mm** (WxD)  
Weight: **58,35 Kg**

**Ladder rack** complete with:

- 4 aluminium crossmembers with fixing connectors and rubber profile
- 2 3000 mm long aluminium side upstand
- 1 aluminium loading roller
- 1 ladder rack rail made from stainless steel and aluminium **TALENTO** series, length 3240 mm

Supplied with **stainless steel** screws for fixing.

**Load capacity: 141 Kg (p.u.d.)**

## READY SOLUTIONS



### Order no. MDL S02

Dimensions: **2032x365x1200 mm** (WxDxH). Weight: **46,35 Kg**

Module complete with:

- 3 trays with rubber and 15 adjustable dividers
- 1 fixing bar length 3000 mm



### Order no. MDL 008

Dimensions: **1016x365x900 mm** (WxDxH). Weight: **41,7 Kg**

Module complete with:

- 1 tray with rubber and 3 adjustable dividers
- 3 drawers
- 1 shelf with door
- 1 hinged door

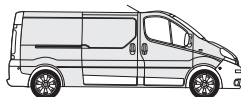

MODULES 717 MM



Suitable to be installed in the zone: **5**

**Order no. MDL 007**

Dimensions: **717x365x900 mm** (WxDxH)

Weight: **42,7 Kg**

Module complete with:

- 3 trays with rubber and 6 adjustable dividers
- 1 retractable vice workbench complete with steel vice with 100 mm jaws and 1/2" to 1 1/2" pipe clamp

MODULES 1016 MM



Suitable to be installed in the zone: **2 3 5**

**Order no. MDL 008**

Dimensions: **1016x365x900 mm** (WxDxH)

Weight: **41,7 Kg**

Module complete with:

- 1 tray with rubber and 3 adjustable dividers
- 2 drawers
- 1 shelf with door
- 1 hinged door



Suitable to be installed in the zone: **2 3 5**

**Order no. MDL 009**

Dimensions: **1016x365x900 mm** (WxDxH)

Weight: **25,4 Kg**

Module complete with:

- 3 trays with rubber and 9 adjustable dividers

\*approximate measurement

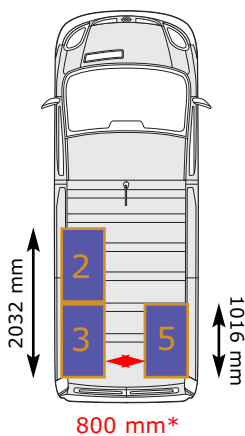

Suitable to be installed in the zone: **2 3 5**

**Order no. MDL 010**

Dimensions: **1016x365x900 mm** (WxDxH)

Weight: **60,1 Kg**

Module complete with:

- 1 tray with rubber and 3 adjustable dividers
- 3 drawers
- 3 retractable shelves for tool cases complete with tool cases and boxes



Suitable to be installed in the zone: **2**

**Order no. MDL 012**

Dimensions: **1016x365x900 mm** (WxDxH)

Weight: **25,2 Kg**

Module complete with:

- 1 tray with rubber and 3 adjustable dividers
- 1 shelf with door
- 1 connection bar with fixing belts for tool cases

Technical features, see page 5

Accessories see page 9

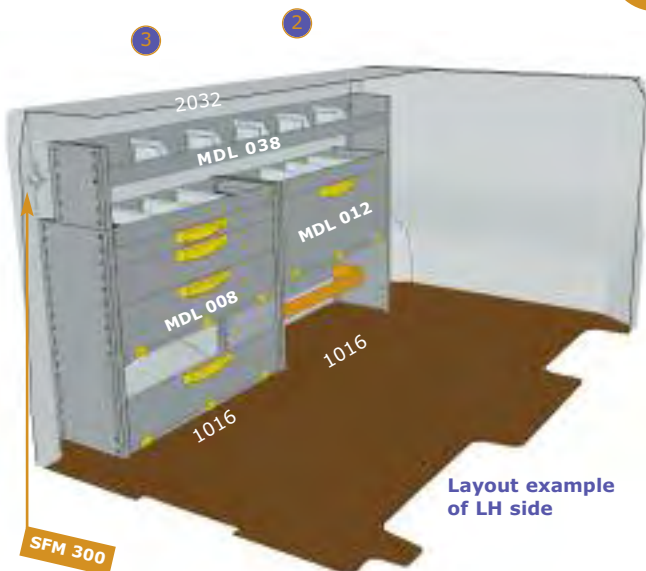

Layout example of LH side

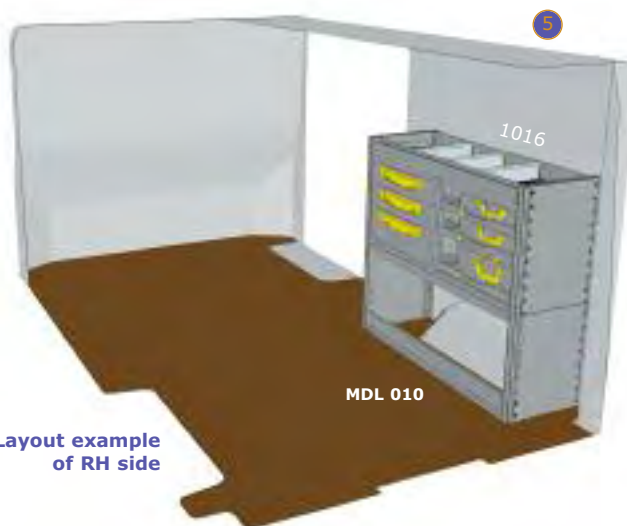

Layout example of RH side

SFM 300



5,9 m<sup>3</sup>  
L2 H1 wheelbase 3498 mm

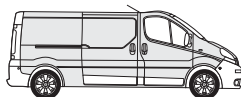

VIVARO Panel Van LWB  
Standard roof

### ADD-ON MODULE 2032 MM



Suitable to be installed in the zone: **2** + **3**

#### Order no. MDL 038

Dimensions: **2032x265x300 mm** (WxDxH)

Weight: **11,20 Kg**

Module complete with:

1 tray with rubber and 5 adjustable dividers



#### Order no. SFM 300

Fixing bar: **3000x30x35 mm** (WxDxH)

Weight: **2,60 Kg**

Fixing bar for upper modules, complete with brackets, bolts and screws.

**The bar is necessary to fix the additional MDL 038 module to the vehicle.**



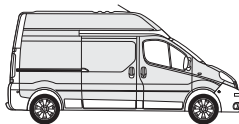

### FLOORINGS AND LININGS

for VIVARO with RH side sliding door and rear leaf doors, sheet metal side walls

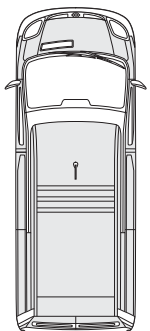

#### A Polypropylene linings

Order no. PAN 204

Weight: **9,61 Kg**

#### Polypropylene linings for:

- LH side wall
- RH side wall and sliding door

Technical features, see page 5

#### C Polypropylene linings

Order no. PAR 204

Weight: **2,45 Kg**

#### Polypropylene linings for:

- upper section of rear leaf doors

#### D Flooring

Order no. PIL 207

Weight: **34,85 Kg**

#### 12 mm thick wooden flooring phenolic coated and predrilling for lashing hook supports.

#### F Bulkhead

Order no. PIR 201

Weight: **10,60 Kg**

#### 12 mm wooden phenolic coated bulkhead panel.

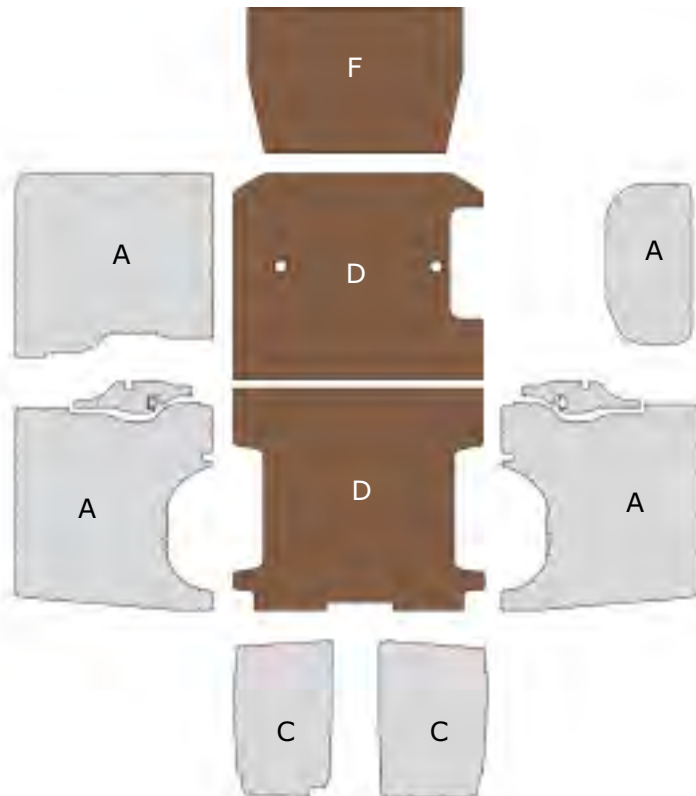

## ROOF RACK



### Order no. POT 206

Dimensions: **2750x1600 mm** (WxD)

Weight: **29,58 Kg**

#### Roof rack complete with:

- 4 aluminium crossmembers with fixing connectors and rubber profile
- 2 2750 mm long aluminium side upstands
- 1 aluminium loading roller

Supplied with **stainless steel** screws for fixing.

**Load capacity: 170 Kg (p.u.d.)**

Technical features, see page 7

## LADDER RACK

The ladder rack rail can be mounted on the right or on the left hand side of the vehicle



### Order no. POS 206

Dimensions: **2750x1580 mm** (WxD)

Weight: **58,36 Kg**

#### Ladder rack complete with:

- 4 aluminium crossmembers with fixing connectors and rubber profile
- 1 2750 mm long aluminium side upstand
- 1 aluminium loading roller
- 1 ladder rack rail made from stainless steel and aluminium ALADIN series, length 2650 mm
- 1 aluminium connection crossmember

Supplied with **stainless steel** screws for fixing.

**Load capacity: 141 Kg (p.u.d.)**

8,4 m<sup>3</sup>  
L2 H2 wheelbase 3498 mm



VIVARO Panel Van LWB  
High roof

36

## READY SOLUTIONS



### Order no. MDL 030

Dimensions: **2032x365x1200 mm** (WxDxH). Weight: **45,15 Kg**

Module complete with:

- 3 trays with rubber and 15 adjustable dividers



### Order no. MDL 014

Dimensions: **1016x365x1200 mm** (WxDxH). Weight: **49,4 Kg**

Module complete with:

- 2 trays with rubber and 6 adjustable dividers
- 2 drawers
- 1 shelf with door
- 1 hinged door







MODULES 1016 MM



Suitable to be installed in the zone: **3** **5**

**Order no. MDL 161**

Dimensions: **1016x365x1700 mm** (WxDxH)

Weight: **61,38 Kg**

Module complete with:

- 4 trays with rubber and 12 adjustable dividers
- 2 drawers
- 1 shelf with door
- 1 hinged door

Suitable to be installed in the zone: **3** **5**

**Order no. MDL 162**

Dimensions: **1016x365x1700 mm** (WxDxH)

Weight: **58,07 Kg**

Module complete with:

- 5 trays with rubber and 15 adjustable dividers
- 1 drawer
- 1 retractable shelf for tool cases complete with tool cases and boxes

Suitable to be installed in the zone: **3** **5**

**Order no. MDL 163**

Dimensions: **1016x365x1700 mm** (WxDxH)

Weight: **40,20 Kg**

Module complete with:

- 6 trays with rubber and 18 adjustable dividers

\*approximate measurement

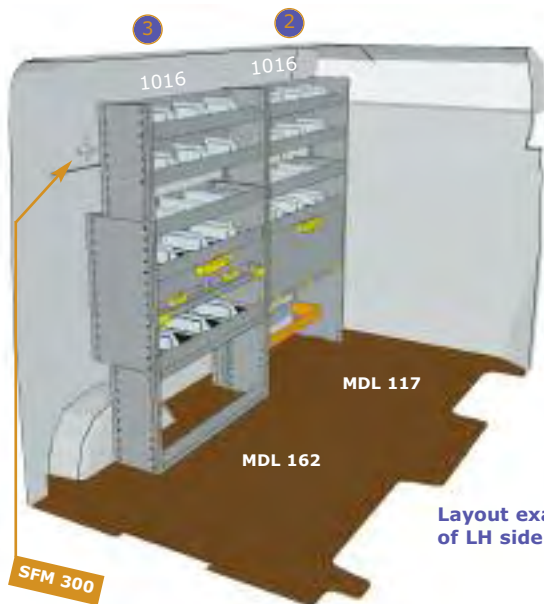
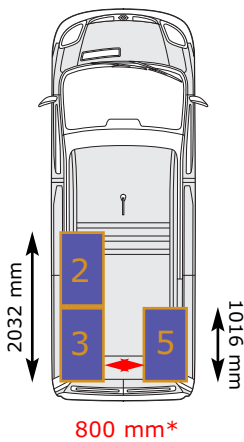

Layout example of LH side



Layout example of RH side



MODULES 1016 MM



Suitable to be installed in the zone: **5**

**Order no. MDL 164**

Dimensions: **1016x365x1700 mm** (WxDxH)

Weight: **64,40 Kg**

Module complete with:

- 6 trays with rubber and 18 adjustable dividers
- 1 retractable vice workbench complete with steel vice with 100 mm jaws and 1/2" to 1½" pipe clamp



Suitable to be installed in the zone: **2**

**Order no. MDL 114**

Dimensions: **1016x365x1700 mm** (WxDxH)

Weight: **62,90 Kg**

Module complete with:

- 4 trays with rubber and 12 adjustable dividers
- 2 drawers
- 1 shelf with door
- 1 hinged door



Suitable to be installed in the zone: **2**

**Order no. MDL 115**

Dimensions: **1016x365x1700 mm** (WxDxH)

Weight: **61,80 Kg**

Module complete with:

- 5 trays with rubber and 15 adjustable dividers
- 1 drawer
- 1 retractable shelf for tool cases complete with tool cases and boxes



Suitable to be installed in the zone: **2**

**Order no. MDL 116**

Dimensions: **1016x365x1700 mm** (WxDxH)

Weight: **46,70 Kg**

Module complete with:

- 6 trays with rubber and 18 adjustable dividers



Suitable to be installed in the zone: **2**

**Order no. MDL 117**

Dimensions: **1016x365x1700 mm** (WxDxH)

Weight: **46,50 Kg**

Module complete with:

- 4 trays with rubber and 12 adjustable dividers
- 1 shelf with door
- 1 connection bar with fixing belts for tool cases

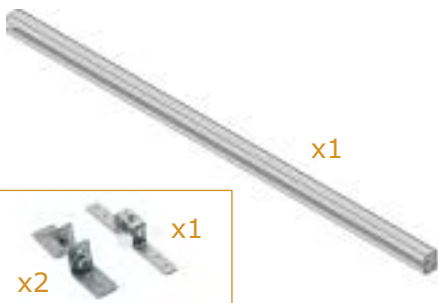

**Order no. SFM 300**

Fixing bar: **3000x30x35 mm** (WxDxH)

Weight: **2,60 Kg**

Fixing bar for modules, complete with brackets, bolts and screws.

**The bar is necessary to fix the modules to the vehicle.**

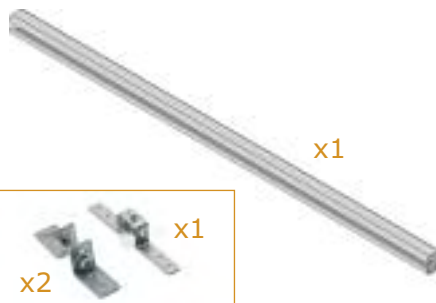

**Order no. SFM 150**

Fixing bar: **1500x30x35 mm** (WxDxH)

Weight: **1,55 Kg**

Fixing bar for modules, complete with brackets, bolts and screws.

**The bar is necessary to fix the modules to the vehicle.**

# Strategically strong



## Movano L2 H2 - 10,8 m<sup>3</sup>

### Vehicle equipped with:

1	ord. no. POS 209	ladder rack (ladder not supplied)
1	ord. no. PIL 210	wooden flooring
1	ord. no. PAN 207	polypropylene linings
1	ord. no. MDL 161	module
1	ord. no. MDL 121	module
2	ord. no. MDL 147	module
1	ord. no. MDL 164	module
1	ord. no. SFM 300	fixing bar
1	ord. no. SFM 200	fixing bar
1	ord. no. ACS 004	first aid kit
2	ord. no. ACS 007	spray cans holder
1	ord. no. ACS 005	paper roll holder with paper roll
1	ord. no. ACS 003	support with belt for gas cylinders and extinguishers (extinguisher not supplied)

- › **FAST ASSEMBLY**
- › **TOTAL MODULARITY**
- › **SAFETY SOUND ABSORBING ELEMENTS BETWEEN THE VARIOUS METAL COMPONENTS**
- › **ERGONOMETRIC SHAPES**
- › **HEIGHT ADJUSTMENT IN PITCH OF 25 mm OF THE VARIOUS ELEMENTS**





# MOVIANO









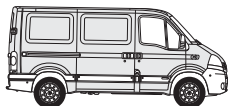

### FLOORINGS AND LININGS

for MASTER with RH side sliding door and rear leaf doors, sheet metal side walls

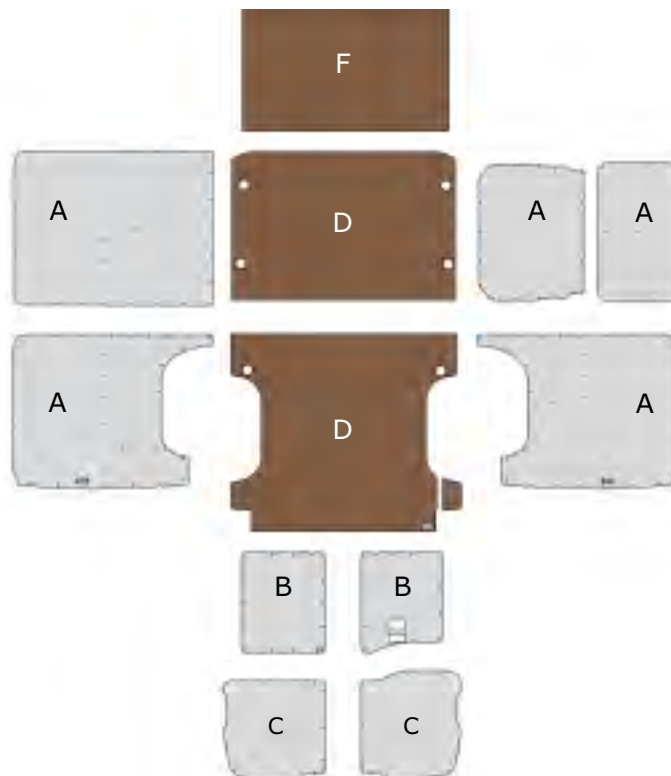
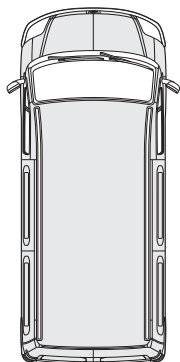

#### **A + B** Polypropylene linings Order no. PAN 205

Weight: **13,55 Kg**

**Polypropylene linings for:**

- LH side wall
- RH side wall and sliding door
- lower section of rear leaf doors

Technical features,  
see page 5

#### **C** Polypropylene linings Order no. PAR 205

Weight: **2,40 Kg**

**Polypropylene linings for:**

- upper section of rear leaf doors

#### **D** Flooring Order no. PIL 209

Weight: **36,45 Kg**

**12 mm thick wooden flooring phenolic coated** and predrilling for lashing hook supports.

#### **F** Bulkhead Art. PIR 202

Weight: **12,55 Kg**

**12 mm wooden phenolic coated bulkhead panel.**

### ROOF RACK



#### Order no. POT 207

Dimensions: **2500x1700 mm (WxD)**

Weight: **29,60 Kg**

**Roof rack complete with:**

- 3 aluminium crossmembers with fixing connectors and rubber profile
- 1 additional crossmember with supports
- 2 2500 mm long aluminium side upstands
- 1 aluminium loading roller

Supplied with **stainless steel** screws for fixing.

**Load capacity: 120 Kg (p.u.d.)**

Technical features,  
see page 7

### LADDER RACK

The ladder rack rail can be mounted on the right or on the left hand side of the vehicle



#### Order no. POS 207

Dimensions: **2650x1680 mm (WxD)**

Weight: **54,90 Kg**

**Ladder rack complete with:**

- 3 aluminium crossmembers with fixing connectors and rubber profile
- 1 2500 mm long aluminium side upstand
- 1 aluminium loading roller
- 1 ladder rack rail made from stainless steel and aluminium **TALENTO** series, length 2650 mm

Supplied with **stainless steel** screws for fixing.

**Load capacity: 95 Kg (p.u.d.)**

8 m<sup>3</sup>  
L1 H1 wheelbase 3078 mm



**MOVANO Panel Van SWB**  
**Standard roof**

## LOADING RAMP

### Order no. RAM 201

Dimensions: **1250x2500 mm** (WxD)

Weight: **118,85 Kg**

**Swivel loading ramp.**

**Load capacity: 1000 Kg (p.u.d.)**



Technical  
features,  
see page 8

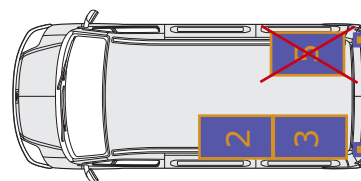

**RAM**  
**201**

The swivel loading ramp can be installed also when the modules are fitted.

If the loading ramp is fitted, the MDL modules for the areas **2** and **3** must not be longer than 1016 mm. MDL series modules for the area **5** cannot be installed.

It is advisable to ask your nearest STORE VAN distributor for a project feasibility study.



**MODULES 1016 MM**

 Suitable to be installed in the zone: **3 5**
**Art. MDL 061**

 Dimensions: **1016x365x1200 mm** (WxDxH)

 Weight: **47,88 Kg**

Module complete with:

- 2 trays with rubber and 6 adjustable dividers
- 2 drawers
- 1 shelf with door
- 1 hinged door

 Suitable to be installed in the zone: **3 5**
**Art. MDL 062**

 Dimensions: **1016x365x1200 mm** (WxDxH)

 Weight: **44,57 Kg**

Module complete with:

- 3 trays with rubber and 9 adjustable dividers
- 1 drawer
- 1 retractable shelf for tool cases complete with tool cases and boxes



 Suitable to be installed in the zone: **3 5**
**Art. MDL 063**

 Dimensions: **1016x365x1200 mm** (WxDxH)

 Weight: **26,7 Kg**

Module complete with:

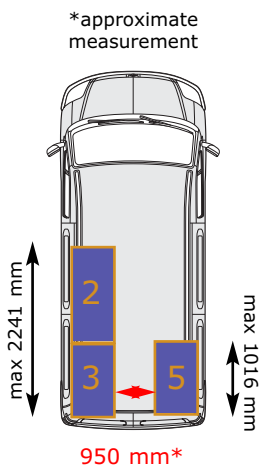
- 4 trays with rubber and 12 adjustable dividers



 Suitable to be installed in the zone: **5**
**Art. MDL 064**

 Dimensions: **1016x365x1200 mm** (WxDxH)

 Weight: **50,90 Kg**

Module complete with:

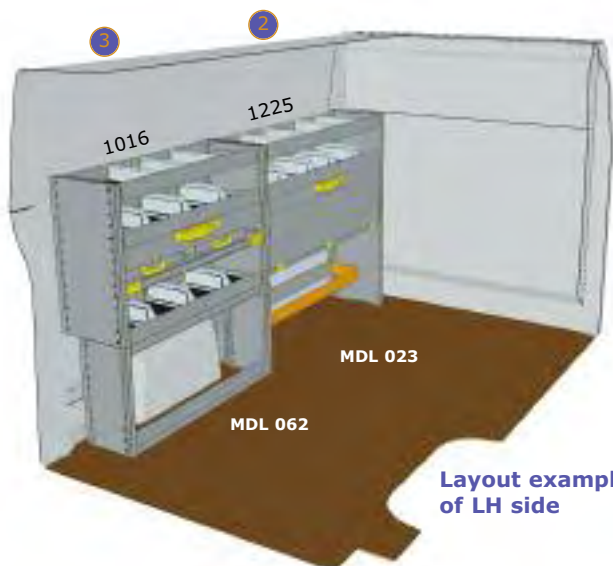
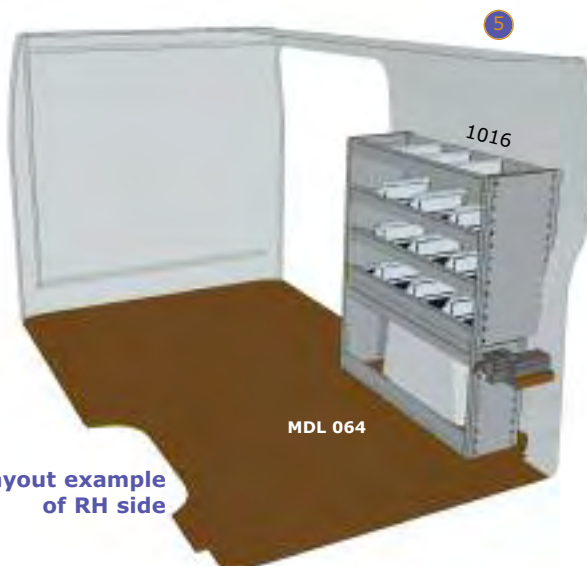
- 4 trays with rubber and 12 adjustable dividers
- 1 retractable vice workbench complete with steel vice with 100 mm jaws and 1/2" to 1 1/2" pipe clamp

 Layout example  
 of LH side

 Layout example  
 of RH side



8 m<sup>3</sup>  
L1 H1 wheelbase 3078 mm



MOVANO Panel Van SWB  
Standard roof

## MODULES 1225 MM



Suitable to be installed in the zone: **2**

### Order no. MDL 020

Dimensions: **1225x365x1200 mm** (WxDxH)

Weight: **57,35 Kg**

Module complete with:

- 2 trays with rubber and 8 adjustable dividers
- 2 drawers
- 1 shelf with door
- 1 hinged door



Suitable to be installed in the zone: **2**

### Order no. MDL 021

Dimensions: **1225x365x1200 mm** (WxDxH)

Weight: **55,35 Kg**

Module complete with:

- 3 trays with rubber and 12 adjustable dividers
- 1 drawer
- 1 retractable shelf for tool cases complete with tool cases and boxes



Suitable to be installed in the zone: **2**

### Order no. MDL 022

Dimensions: **1225x365x1200 mm** (WxDxH)

Weight: **39,40 Kg**

Module complete with:

- 4 trays with rubber and 16 adjustable dividers



Suitable to be installed in the zone: **2**

### Order no. MDL 023

Dimensions: **1225x365x1200 mm** (WxDxH)

Weight: **39,05 Kg**

Module complete with:

- 2 trays with rubber and 8 adjustable dividers
- 1 shelf with door
- 1 connection bar with fixing belts for tool cases

Technical  
features,  
see page 5

Accessories  
see page 9



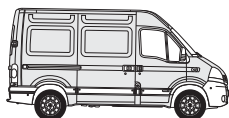

## FLOORINGS AND LININGS

for MASTER with RH side sliding door and rear leaf doors, sheet metal side walls

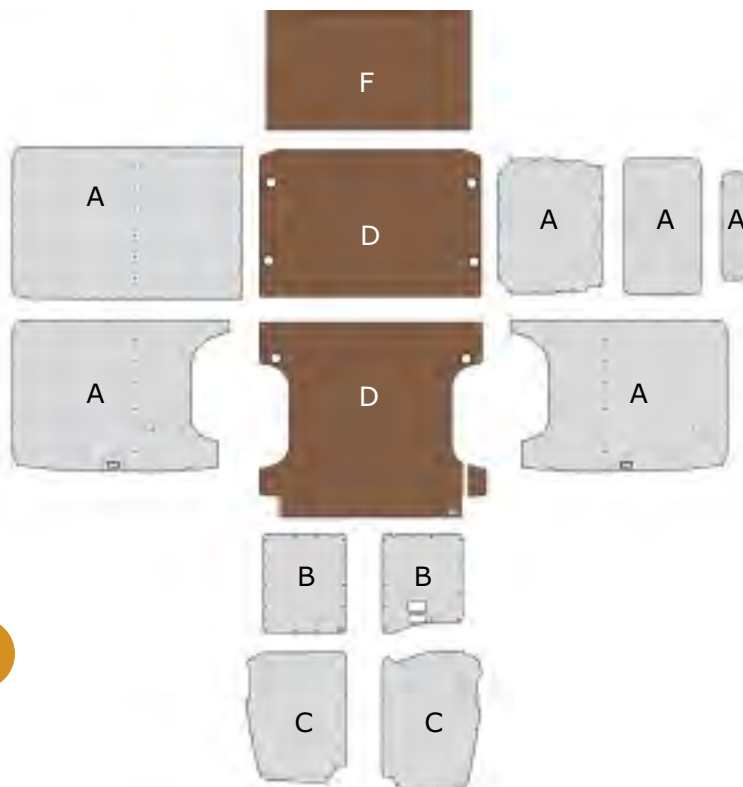
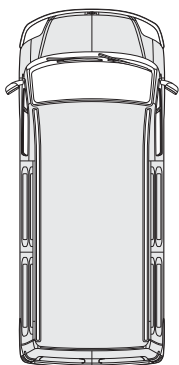

### **A + B** Polypropylene linings

**Art. PAN 206**

Weight : **15,57 Kg**

**Polypropylene linings for:**

- LH side wall
- RH side wall and sliding door
- lower section of rear leaf doors

Technical features,  
see page 5

### **C** Polypropylene linings

**Art. PAR 206**

Weight : **2,85 Kg**

**Polypropylene linings for:**

- upper section of rear leaf doors

### **D** Flooring

**Art. PIL 209**

Weight : **36,45 Kg**

**12 mm thick wooden flooring phenolic coated** and predrilling for lashing hook supports.

### **F** Bulkhead

**Art. PIR 202**

Weight : **12,55 Kg**

**12 mm wooden phenolic coated bulkhead panel.**

## ROOF RACK



### **Art. POT 208**

Dimensions: **2500x1600 mm (WxD)**

Weight: **28,70 Kg**

**Roof rack complete with:**

- 3 aluminium crossmembers with fixing connectors and rubber profile
- 1 additional crossmember with supports
- 2 2500 mm long aluminium side upstands
- 1 aluminium loading roller

Supplied with **stainless steel** screws for fixing.

**Load capacity: 121 Kg (p.u.d.)**

Technical features,  
see page 7

## LADDER RACK

The ladder rack rail can be mounted on the right or on the left hand side of the vehicle



### **Art. POS 208**

Dimensions: **2650x1580 mm (WxD)**

Weight: **54,35 Kg**

**Ladder rack complete with:**

- 3 aluminium crossmembers with fixing connectors and rubber profile
- 1 2500 mm long aluminium side upstand
- 1 aluminium loading roller
- 1 ladder rack rail made from stainless steel and aluminium **ALADIN** series, length 2650 mm

Supplied with **stainless steel** screws for fixing.

**Load capacity: 95 Kg (p.u.d.)**

9,1 m<sup>3</sup>  
L1 H2 wheelbase 3078 mm



MOVANO Panel Van SWB  
High roof

## LOADING RAMP

### Order no. RAM 202

Dimensions: **1250x2500 mm** (WxD)

Weight: **118,85 Kg**

Swivel loading ramp.

Load capacity: **1000 Kg** (p.u.d.)



Technical  
features,  
see page 8

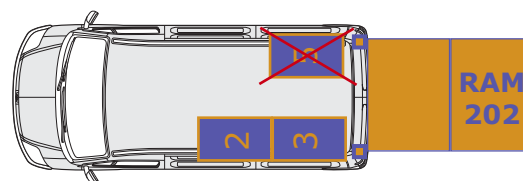

RAM  
202

The swivel loading ramp can be installed also when the modules are fitted.

If the loading ramp is fitted, the MDL modules for the areas **2** and **3** must not be longer than 1016 mm. MDL series modules for the area **5** cannot be installed.

It is advisable to ask your nearest STORE VAN distributor for a project feasibility study.







MODULES 1016 MM



Suitable to be installed in the zone: **3 5**

**Order no. MDL 161**

Dimensions: **1016x365x1700 mm** (WxDxH)

Weight: **61,38 Kg**

Module complete with:

- 4 trays with rubber and 12 adjustable dividers
- 2 drawers
- 1 shelf with door
- 1 hinged door

Suitable to be installed in the zone: **3 5**

**Order no. MDL 162**

Dimensions: **1016x365x1700 mm** (WxDxH)

Weight: **58,07 Kg**

Module complete with:

- 5 trays with rubber and 15 adjustable dividers
- 1 drawer
- 1 retractable shelf for tool cases complete with tool cases and boxes

Suitable to be installed in the zone: **3 5**

**Order no. MDL 163**

Dimensions: **1016x365x1700 mm** (WxDxH)

Weight: **40,20 Kg**

Module complete with:

- 6 trays with rubber and 18 adjustable dividers

\*approximate measurement

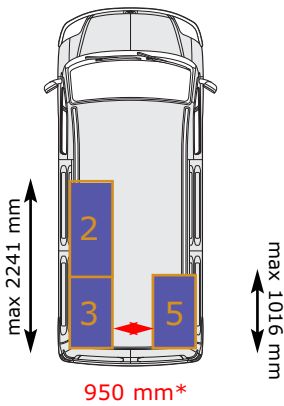

Technical features, see page 5

Accessories see page 9



Suitable to be installed in the zone: **5**

**Order no. MDL 164**

Dimensions: **1016x365x1700 mm** (WxDxH)

Weight: **64,40 Kg**

Module complete with:

- 6 trays with rubber and 18 adjustable dividers
- 1 retractable vice workbench complete with steel vice with 100 mm jaws and 1/2" to 1 1/2" pipe clamp



Layout example of LH side



Layout example of RH side

9,1 m<sup>3</sup>  
L1 H2 wheelbase 3078 mm



MODULES 1225 MM



Suitable to be installed in the zone: **2**

**Order no. MDL 120**

Dimensions: **1225x365x1700 mm** (WxDxH)  
Weight: **72,95 Kg**

Module complete with:

- 4 trays with rubber and 16 adjustable dividers
- 2 drawers
- 1 shelf with door
- 1 hinged door

Suitable to be installed in the zone: **2**

**Order no. MDL 121**

Dimensions: **1225x365x1700 mm** (WxDxH)  
Weight: **70,95 Kg**

Module complete with:

- 5 trays with rubber and 20 adjustable dividers
- 1 drawer
- 1 retractable shelf for tool cases complete with tool cases and boxes



Suitable to be installed in the zone: **2**

**Order no. MDL 122**

Dimensions: **1225x365x1700 mm** (WxDxH)  
Weight: **55,00 Kg**

Module complete with:

- 6 trays with rubber and 24 adjustable dividers

Suitable to be installed in the zone: **2**

**Order no. MDL 123**

Dimensions: **1225x365x1700 mm** (WxDxH)  
Weight: **54,65 Kg**

Module complete with:

- 4 trays with rubber and 16 adjustable dividers
- 1 shelf with door
- 1 connection bar with fixing belts for tool cases

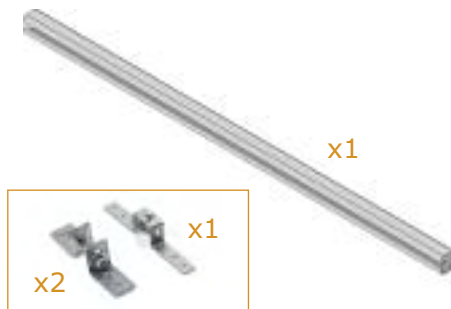

**Order no. SFM 150**

Fixing bar: **1500x30x35 mm** (WxDxH)

Weight: **1,55 Kg**

Fixing bar for modules, complete with brackets, bolts and screws.

**The bar is necessary to fix the modules to the vehicle.**

**Order no. SFM 250**

Fixing bar: **2500x30x35 mm** (WxDxH)

Weight: **2,2 Kg**

Fixing bar for modules, complete with brackets, bolts and screws.

**The bar is necessary to fix the modules to the vehicle.**

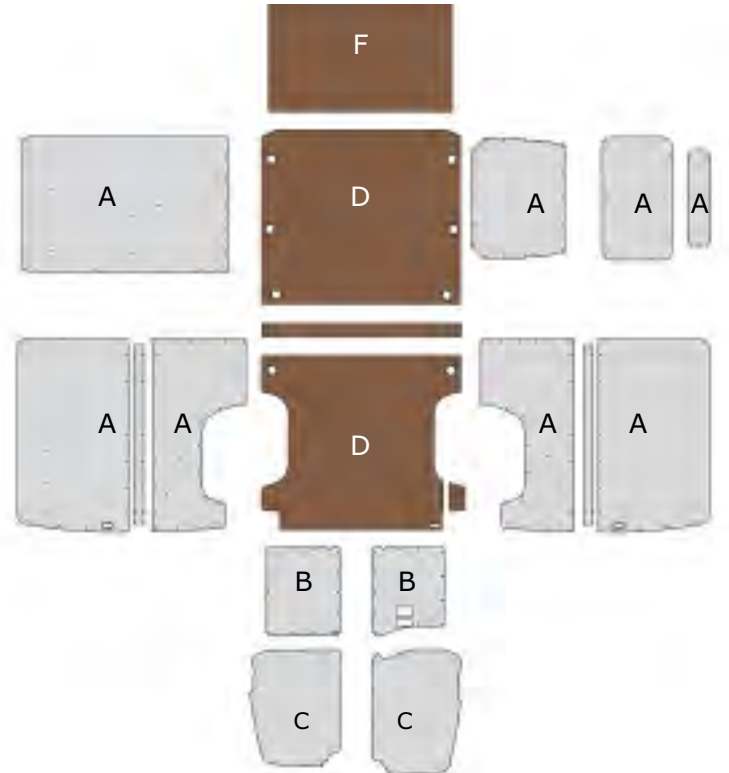
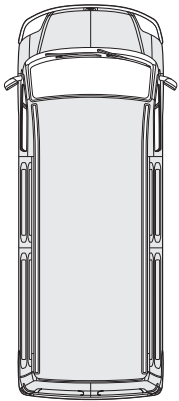

**FLOORINGS AND LININGS**
**for MASTER with RH side sliding door and rear leaf doors, sheet metal side walls**

**A + B Polypropylene linings**  
**Art. PAN 207**

 Weight : **21,05 Kg**
**Polypropylene linings for:**

- LH side wall
- RH side wall and sliding door
- lower section of rear leaf doors

 Technical  
 features,  
 see page 5

**C Polypropylene linings**  
**Art. PAR 206**

 Weight : **2,85 Kg**
**Polypropylene linings for:**

- upper section of rear leaf doors

**D Flooring**  
**Art. PIL 210**

 Weight : **44,25 Kg**
**12 mm thick wooden flooring phenolic coated** and predrilling for lashing hook supports.

**F Bulkhead**  
**Art. PIR 202**

 Weight : **12,55 Kg**
**12 mm wooden phenolic coated bulkhead panel.**
**ROOF RACK**

**Order no. POT 209**

 Dimensions: **3000x1600 mm** (WxD)

 Weight: **30,88 Kg**
**Roof rack complete with:**

- 4 aluminium crossmembers with fixing connectors and rubber profile
- 2 3000 mm long aluminium side upstands
- 1 aluminium loading roller

 Supplied with **stainless steel** screws for fixing.

**Load capacity: 169 Kg (p.u.d.)**

 Technical  
 features,  
 see page 7

**LADDER RACK**

The ladder rack rail can be mounted on the right or on the left hand side of the vehicle

**Order no. POS 209**

 Dimensions: **3240x1580 mm** (WxD)

 Weight: **62,00 Kg**
**Ladder rack complete with:**

- 4 aluminium crossmembers with fixing connectors and rubber profile
- 2 3000 mm long aluminium side upstand
- 1 aluminium loading roller
- 1 ladder rack rail made from stainless steel and aluminium **ALADIN** series, length 3240 mm

 Supplied with **stainless steel** screws for fixing.

**Load capacity: 138 Kg (p.u.d.)**



10,8 m<sup>3</sup>  
L2 H2 wheelbase 3578 mm



MOVANO Panel Van MWB  
High roof

## LOADING RAMP

### Order no. RAM 202

Dimensions: **1250x2500 mm** (WxD)  
Weight: **118,85 Kg**

Swivel loading ramp.

Load capacity: **1000 Kg** (p.u.d.)



Technical  
features,  
see page 8

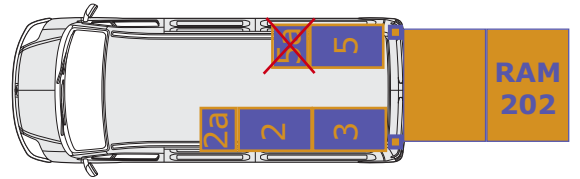

The swivel loading ramp can be installed also when the modules are fitted.  
If the loading ramp is fitted, the MDL modules for the areas **2** and **3** must not be longer than 1016 mm.  
If the loading ramp is installed the article **MDL 164 cannot be installed** in area **5**.  
MDL series modules for the area **5a** cannot be installed.  
It is advisable to ask your nearest STORE VAN distributor for a project feasibility study.

## READY SOLUTIONS



### Order no. MDL S24

Dimensions: **2749x365x1700 mm** (WxDxH). Weight: **96,85 Kg**

Set of 2 modules complete with:

- 10 trays with rubber and 38 adjustable dividers
- 1 shelf with door
- 1 fixing bar length 3000 mm



### Order no. MDL S25

Dimensions: **1016x365x1700 mm** (WxDxH). Weight: **63,25 Kg**

Module complete with:

- 4 trays with rubber and 12 adjustable dividers
- 2 drawers
- 1 shelf with door
- 1 hinged door
- 1 fixing bar length 2000 mm

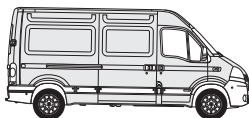

MODULES 1016 MM



Suitable to be installed in the zone: **3 5**

**Order no. MDL 161**

Dimensions: **1016x365x1700 mm** (WxDxH)  
Weight: **61,38 Kg**

Module complete with:

- 4 trays with rubber and 12 adjustable dividers
- 2 drawers
- 1 shelf with door
- 1 hinged door

Suitable to be installed in the zone: **3 5**

**Order no. MDL 162**

Dimensions: **1016x365x1700 mm** (WxDxH)  
Weight: **58,07 Kg**

Module complete with:

- 5 trays with rubber and 15 adjustable dividers
- 1 drawer
- 1 retractable shelf for tool cases complete with tool cases and boxes

Suitable to be installed in the zone: **3 5**

**Order no. MDL 163**

Dimensions: **1016x365x1700 mm** (WxDxH)  
Weight: **40,20 Kg**

Module complete with:

- 6 trays with rubber and 18 adjustable dividers

\*approximate measurement

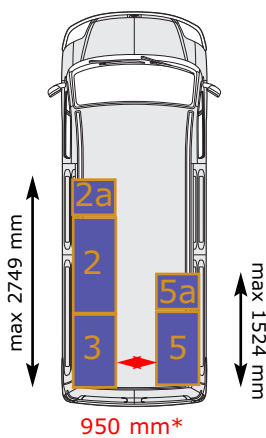

Technical features, see page 5

Accessories see page 9



Suitable to be installed in the zone: **5**

**Order no. MDL 164**

Dimensions: **1016x365x1700 mm** (WxDxH)  
Weight: **64,40 Kg**

Module complete with:

- 6 trays with rubber and 18 adjustable dividers
- 1 retractable vice workbench complete with steel vice with 100 mm jaws and 1/2" to 1 1/2" pipe clamp

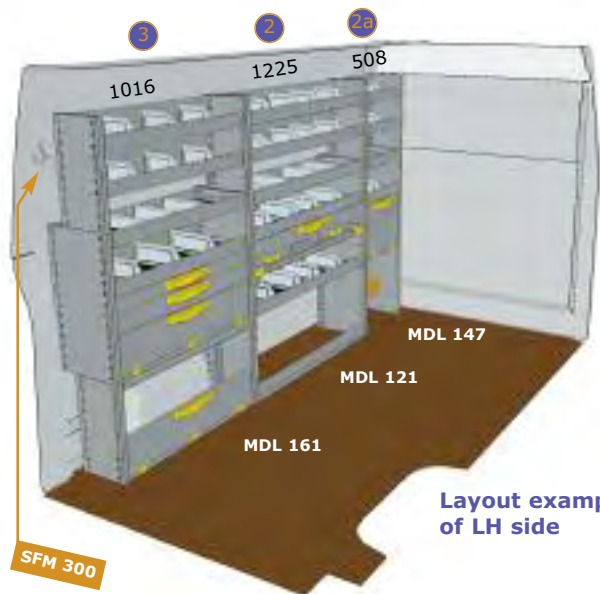

Layout example of LH side



Layout example of RH side

10,8 m<sup>3</sup>  
L2 H2 wheelbase 3578 mm



MOVANO Panel Van MWB  
High roof

### MODULES 1225 MM



Suitable to be installed in the zone: **2**

#### Order no. MDL 120

Dimensions: **1225x365x1700 mm** (WxDxH)

Weight: **72,95 Kg**

Module complete with:

- 4 trays with rubber and 16 adjustable dividers
- 2 drawers
- 1 shelf with door
- 1 hinged door



Suitable to be installed in the zone: **2**

#### Order no. MDL 121

Dimensions: **1225x365x1700 mm** (WxDxH)

Weight: **70,95 Kg**

Module complete with:

- 5 trays with rubber and 20 adjustable dividers
- 1 drawer
- 1 retractable shelf for tool cases complete with tool cases and boxes



Suitable to be installed in the zone: **2**

#### Order no. MDL 122

Dimensions: **1225x365x1700 mm** (WxDxH)

Weight: **55,00 Kg**

Module complete with:

- 6 trays with rubber and 24 adjustable dividers



Suitable to be installed in the zone: **2**

#### Order no. MDL 123

Dimensions: **1225x365x1700 mm** (WxDxH)

Weight: **54,65 Kg**

Module complete with:

- 4 trays with rubber and 16 adjustable dividers
- 1 shelf with door
- 1 connection bar with fixing belts for tool cases

### MODULI 508 mm



Suitable to be installed in the zone: **2a 5a**

#### Order no. MDL 146

Dimensions: **508x365x1700 mm** (WxDxH)

Weight: **30,80 Kg**

Module complete with:

- 6 trays with rubber and 6 adjustable dividers



Suitable to be installed in the zone: **2a 5a**

#### Order no. MDL 147

Dimensions: **508x365x1700 mm** (WxDxH)

Weight: **32,70 Kg**

Module complete with:

- 4 trays with rubber and 4 adjustable dividers
- 1 shelf with door
- 1 connection bar with fixing belts for tool cases

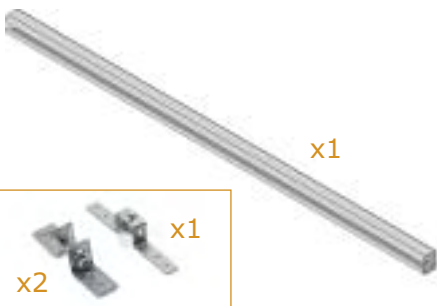

#### Order no. SFM 200

Fixing bar: **2000x30x35 mm** (WxDxH)

Weight: **1,88 Kg**

Fixing bar for modules, complete with brackets, bolts and screws.

**The bar is necessary to fix the modules to the vehicle.**

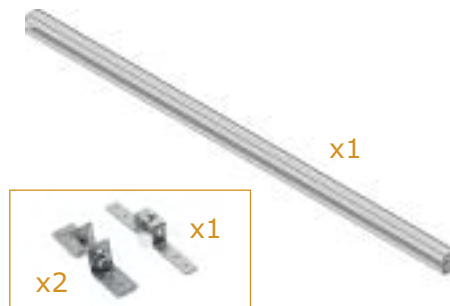

#### Order no. SFM 300

Fixing bar: **3000x30x35 mm** (WxDxH)

Weight: **2,60 Kg**

Fixing bar for modules, complete with brackets, bolts and screws.

**The bar is necessary to fix the modules to the vehicle.**



**FLOORINGS AND LININGS**

for MASTER with RH side sliding door and rear leaf doors, sheet metal side walls

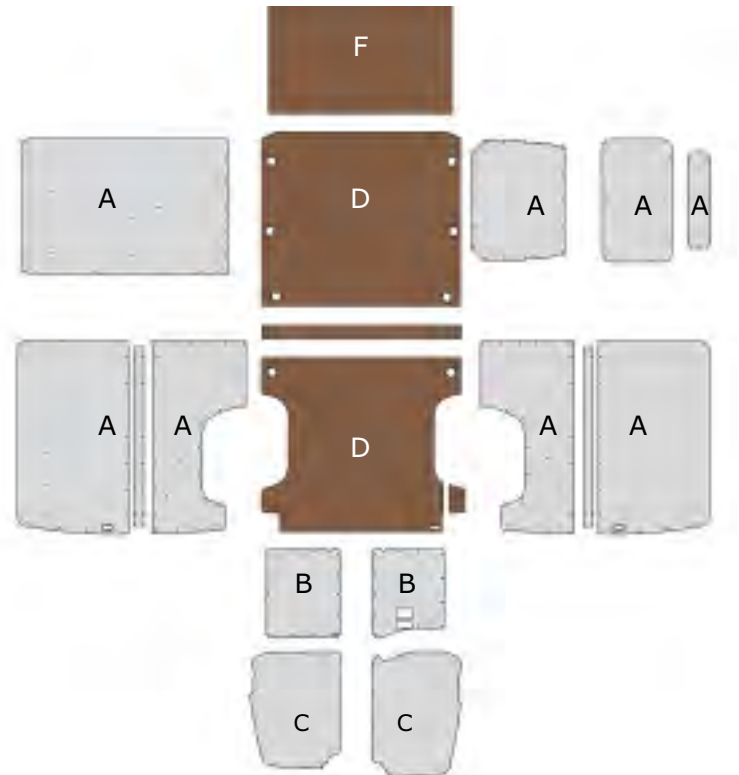
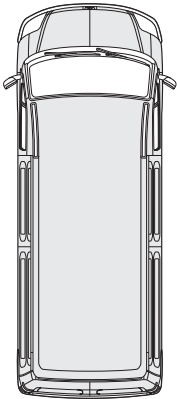
**A + B Polypropylene linings**  
**Order no. PAN 207**

Weight: **21,05 Kg**

**Polypropylene linings for:**

- LH side wall
- RH side wall and sliding door
- lower section of rear leaf doors

Technical  
features,  
see page 5

**C Polypropylene linings**  
**Order no. PAR 206**

Weight: **2,85 Kg**

**Polypropylene linings for:**

- upper section of rear leaf doors

**D Flooring**  
**Order no. PIL 210**

Weight: **44,25 Kg**

**12 mm thick wooden flooring phenolic coated** and predrilling for lashing hook supports.

**F Bulkhead**  
**Order no. PIR 202**

Weight: **12,55 Kg**

**12 mm wooden phenolic coated bulkhead panel.**



12 m<sup>3</sup>  
L2 H3 wheelbase 3578 mm



MOVANO Panel Van MWB  
Maxi roof

56

## LOADING RAMP

### Order no. RAM 202

Dimensions: **1250x2500 mm** (WxD)  
Weight: **118,85 Kg**

Swivel loading ramp.

Load capacity: **1000 Kg** (p.u.d.)



Technical  
features,  
see page 8

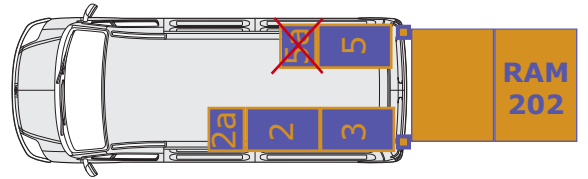

The swivel loading ramp can be installed also when the modules are fitted.  
If the loading ramp is fitted, the MDL modules for the areas **2** and **3** must not be longer than 1016 mm.  
If the loading ramp is installed the article **MDL 164 cannot be installed** in area **5**.  
MDL series modules for the area **5a** cannot be installed.  
It is advisable to ask your nearest STORE VAN distributor for a project feasibility study.

## READY SOLUTIONS



### Order no. MDL S24

Dimensions: **2749x365x1700 mm** (WxDxH). Weight: **96,85 Kg**

Set of 2 modules complete with:

- 10 trays with rubber and 38 adjustable dividers
- 1 shelf with door
- 1 fixing bar length 3000 mm



### Order no. MDL S25

Dimensions: **1016x365x1700 mm** (WxDxH). Weight: **63,25 Kg**

Module complete with:

- 4 trays with rubber and 12 adjustable dividers
- 2 drawers
- 1 shelf with door
- 1 hinged door
- 1 fixing bar length 2000 mm



**MODULES 1016 MM**



Suitable to be installed in the zone: **3 5**

**Order no. MDL 161**

Dimensions: **1016x365x1700 mm** (WxDxH)

Weight: **61,38 Kg**

Module complete with:

- 4 trays with rubber and 12 adjustable dividers
- 2 drawers
- 1 shelf with door
- 1 hinged door

Suitable to be installed in the zone: **3 5**

**Order no. MDL 162**

Dimensions: **1016x365x1700 mm** (WxDxH)

Weight: **58,07 Kg**

Module complete with:

- 5 trays with rubber and 15 adjustable dividers
- 1 drawer
- 1 retractable shelf for tool cases complete with tool cases and boxes

Suitable to be installed in the zone: **3 5**

**Order no. MDL 163**

Dimensions: **1016x365x1700 mm** (WxDxH)

Weight: **40,20 Kg**

Module complete with:

- 6 trays with rubber and 18 adjustable dividers

\*approximate measurement

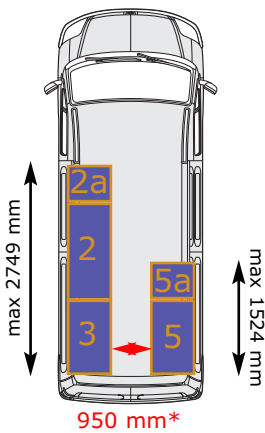

**Technical features, see page 5**  
**Accessories see page 9**



Suitable to be installed in the zone: **5**

**Order no. MDL 164**

Dimensions: **1016x365x1700 mm** (WxDxH)

Weight: **64,40 Kg**

Module complete with:

- 6 trays with rubber and 18 adjustable dividers
- 1 retractable vice workbench complete with steel vice with 100 mm jaws and 1/2" to 1 1/2" pipe clamp

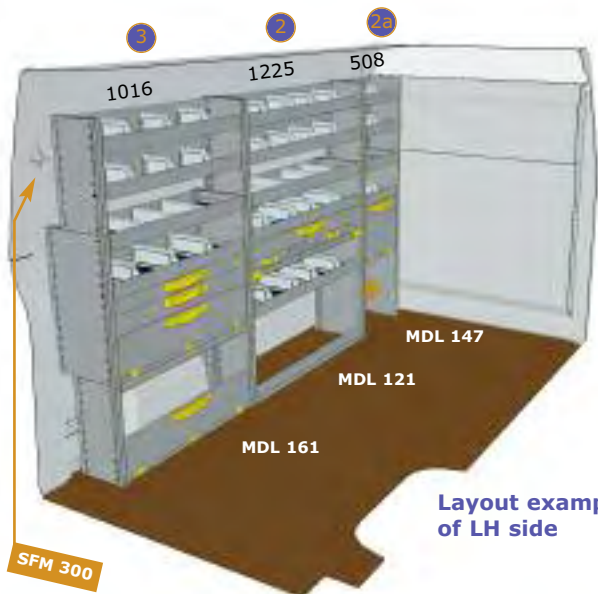

**Layout example of LH side**



**Layout example of RH side**





**MODULES 1225 MM**

**MODULES 508 mm**



Suitable to be installed in the zone: **2**

**Order no. MDL 120**

Dimensions: **1225x365x1700 mm** (WxDxH)

Weight: **72,95 Kg**

Module complete with:

- 4 trays with rubber and 16 adjustable dividers
- 2 drawers
- 1 shelf with door
- 1 hinged door

Suitable to be installed in the zone: **2**

**Order no. MDL 121**

Dimensions: **1225x365x1700 mm** (WxDxH)

Weight: **70,95 Kg**

Module complete with:

- 5 trays with rubber and 20 adjustable dividers
- 1 drawer
- 1 retractable shelf for tool cases complete with tool cases and boxes

Suitable to be installed in the zone: **2a 5a**

**Order no. MDL 146**

Dimensions: **508x365x1700 mm** (WxDxH)

Peso: **30,80 Kg**

Module complete with:

- 6 trays with rubber and 6 adjustable dividers



Suitable to be installed in the zone: **2**

**Order no. MDL 122**

Dimensions: **1225x365x1700 mm** (WxDxH)

Weight: **55,00 Kg**

Module complete with:

- 6 trays with rubber and 24 adjustable dividers

Suitable to be installed in the zone: **2**

**Order no. MDL 123**

Dimensions: **1225x365x1700 mm** (WxDxH)

Weight: **54,65 Kg**

Module complete with:

- 4 trays with rubber and 16 adjustable dividers
- 1 shelf with door
- 1 connection bar with fixing belts for tool cases

Suitable to be installed in the zone: **2a 5a**

**Order no. MDL 147**

Dimensioni: **508x365x1700 mm** (WxDxH)

Weight: **32,70 Kg**

Module complete with:

- 4 trays with rubber and 4 adjustable dividers
- 1 shelf with door
- 1 connection bar with fixing belts for tool cases

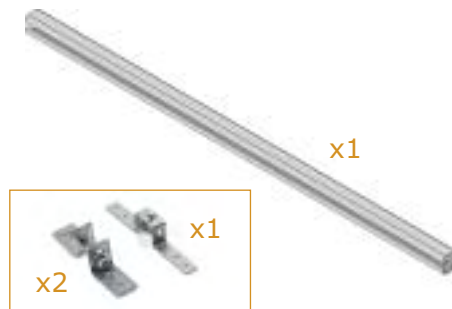
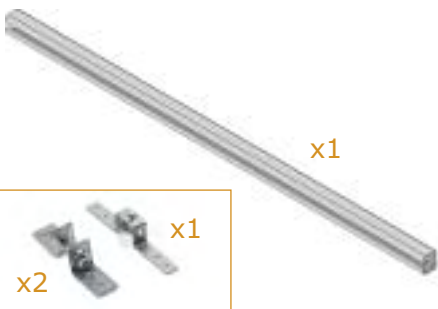

**Order no. SFM 200**

Fixing bar: **2000x30x35 mm** (WxDxH)

Weight: **1,88 Kg**

Fixing bar for modules, complete with brackets, bolts and screws.

**The bar is necessary to fix the modules to the vehicle.**

**Order no. SFM 300**

Fixing bar: **3000x30x35 mm** (WxDxH)

Weight: **2,60 Kg**

Fixing bar for modules, complete with brackets, bolts and screws.

**The bar is necessary to fix the modules to the vehicle.**

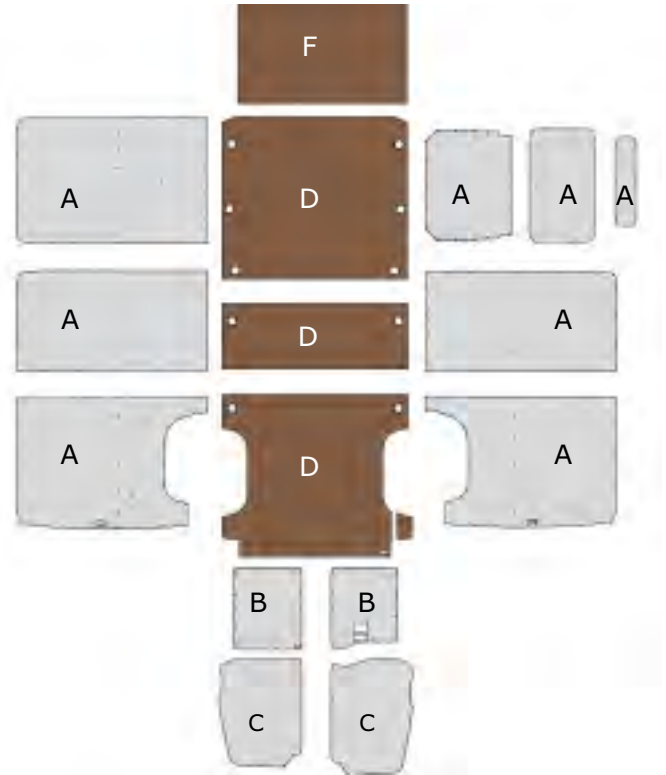
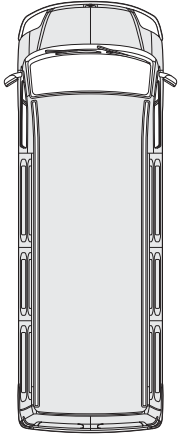
**FLOORINGS AND LININGS**
**for MASTER with RH side sliding door and rear leaf doors, sheet metal side walls**

**A + B Polypropylene linings**  
**Order no. PAN 208**

 Weight: **22,80 Kg**
**Polypropylene linings for:**

- LH side wall
- RH side wall and sliding door
- lower section of rear leaf doors

 Technical  
 features,  
 see page 5

**C Polypropylene linings**  
**Order no. PAR 206**

 Weight: **2,85 Kg**
**Polypropylene linings for:**

- upper section of rear leaf doors

**D Flooring**  
**Order no. PIL 211**

 Weight: **51,40 Kg**
**12 mm thick wooden flooring phenolic coated** and predrilling for lashing hook supports.

**E Bulkhead**  
**Order no. PIR 202**

 Weight: **12,55 Kg**
**12 mm wooden phenolic coated bulkhead panel.**
**ROOF RACK**

**Order no. POT 210**

 Dimensions: **3400x1600 mm** (WxD)

 Weight: **36,50 Kg**
**Roof rack complete with:**

- 5 aluminium crossmembers with fixing connectors and rubber profile
- 2 3400 mm long aluminium side upstands
- 1 aluminium loading roller

 Supplied with **stainless steel** screws for fixing.

**Load capacity: 163 Kg (p.u.d.)**

 Technical  
 features,  
 see page 7

**LADDER RACK**

The ladder rack rail can be mounted on the right or on the left hand side of the vehicle

**Order no. POS 210**

 Dimensions: **3400x1580 mm** (WxD)

 Weight: **69,00 Kg**
**Ladder rack complete with:**

- 5 aluminium crossmembers with fixing connectors and rubber profile
- 1 3400 mm long aluminium side upstand
- 1 aluminium loading roller
- 1 ladder rack rail made from stainless steel and aluminium **ALADIN** series, length 3240 mm

 Supplied with **stainless steel** screws for fixing.

**Load capacity: 131 Kg (p.u.d.)**

12,6 m<sup>3</sup>  
L3 H2 wheelbase 4078 mm



MOVANO Panel Van LWB  
High roof

## LOADING RAMP

### Order no. RAM 202

Dimensions: **1250x2500 mm** (WxD)  
Weight: **118,85 Kg**

Swivel loading ramp.

Load capacity: **1000 Kg** (p.u.d.)



Technical  
features,  
see page 8

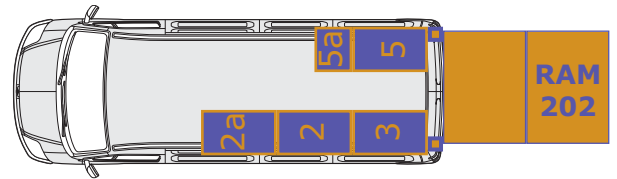

The swivel loading ramp can be installed also when the modules are fitted.  
If the loading ramp is fitted, the MDL modules for the areas **2, 2a** and **3** must not be longer than 1016 mm.  
If the loading ramp is fitted, the MDL modules for the areas **5a** must not be longer than 508 mm.  
If the loading ramp is installed the article **MDL 164 cannot be installed** in area **5**.  
It is advisable to ask your nearest STORE VAN distributor for a project feasibility study.

## READY SOLUTIONS



### Order no. MDL S26

Dimensions: **3048x365x1700 mm** (WxDxH). Weight: **100,68 Kg**  
Set of 2 modules complete with:  
10 trays with rubber and 38 adjustable dividers  
1 fixing bar length 3500 mm



### Order no. MDL S27

Dimensions: **2032x365x1700 mm** (WxDxH). Weight: **105,30 Kg**  
Module complete with:  
10 trays with rubber and 30 adjustable dividers  
2 drawers  
1 shelf with door  
1 hinged door  
1 fixing bar length 2500 mm





MODULES 1016 MM



Suitable to be installed in the zone: **3 5**

**Order no. MDL 161**

Dimensions: **1016x365x1700 mm** (WxDxH)

Weight: **61,38 Kg**

Module complete with:

- 4 trays with rubber and 12 adjustable dividers
- 2 drawers
- 1 shelf with door
- 1 hinged door

Suitable to be installed in the zone: **3 5**

**Order no. MDL 162**

Dimensions: **1016x365x1700 mm** (WxDxH)

Weight: **58,07 Kg**

Module complete with:

- 5 trays with rubber and 15 adjustable dividers
- 1 drawer
- 1 retractable shelf for tool cases complete with tool cases and boxes

Suitable to be installed in the zone: **3 5**

**Order no. MDL 163**

Dimensions: **1016x365x1700 mm** (WxDxH)

Weight: **40,20 Kg**

Module complete with:

- 6 trays with rubber and 18 adjustable dividers



Suitable to be installed in the zone: **2 2a 5a**

**Order no. MDL 114**

Dimensions: **1016x365x1700 mm** (WxDxH)

Weight: **62,90 Kg**

Module complete with:

- 4 trays with rubber and 12 adjustable dividers
- 2 drawers
- 1 shelf with door
- 1 hinged door

Suitable to be installed in the zone: **5**

**Order no. MDL 164**

Dimensions: **1016x365x1700 mm** (WxDxH)

Weight: **64,40 Kg**

Module complete with:

- 6 trays with rubber and 18 adjustable dividers
- 1 retractable vice workbench complete with steel vice with 100 mm jaws and 1/2" to 1 1/2" pipe clamp

Suitable to be installed in the zone: **2 2a 5a**

**Order no. MDL 116**

Dimensions: **1016x365x1700 mm** (WxDxH)

Weight: **46,70 Kg**

Module complete with:

- 6 trays with rubber and 18 adjustable dividers

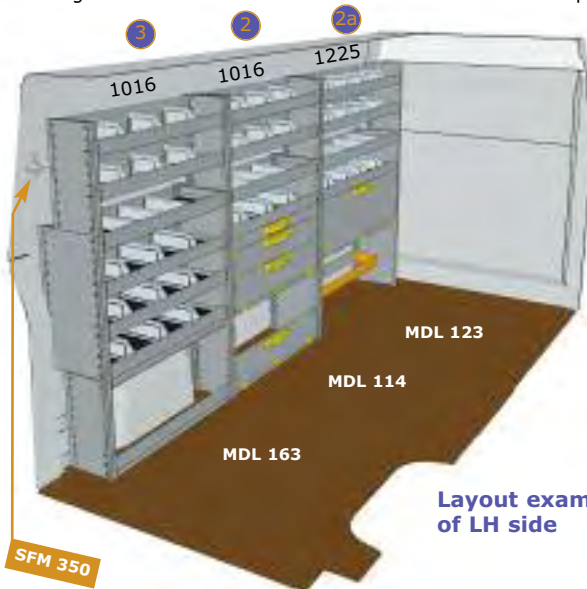

Layout example of LH side



Layout example of RH side

SFM 350

SFM 250



**MODULES 1016 MM**



Suitable to be installed in the zone: **2 2a 5a**

**Order no. MDL 115**

Dimensions: **1016x365x1700 mm** (WxDxH)

Weight: **61,80 Kg**

Module complete with:

- 5 trays with rubber and 15 adjustable dividers
- 1 drawer
- 1 retractable shelf for tool cases complete with tool cases and boxes



Suitable to be installed in the zone: **2 2a 5a**

**Order no. MDL 117**

Dimensions: **1016x365x1700 mm** (WxDxH)

Weight: **46,50 Kg**

Module complete with:

- 4 trays with rubber and 12 adjustable dividers
- 1 shelf with door
- 1 connection bar with fixing belts for tool cases

**MODULES 1225 MM**



Suitable to be installed in the zone: **2a**

**Order no. MDL 120**

Dimensions: **1225x365x1700 mm** (WxDxH)

Weight: **72,95 Kg**

Module complete with:

- 4 trays with rubber and 16 adjustable dividers
- 2 drawers
- 1 shelf with door
- 1 hinged door



Suitable to be installed in the zone: **2a**

**Order no. MDL 122**

Dimensions: **1225x365x1700 mm** (WxDxH)

Weight: **55,00 Kg**

Module complete with:

- 6 trays with rubber and 24 adjustable dividers



Suitable to be installed in the zone: **2a**

**Order no. MDL 121**

Dimensions: **1225x365x1700 mm** (WxDxH)

Weight: **70,95 Kg**

Module complete with:

- 5 trays with rubber and 20 adjustable dividers
- 1 drawer
- 1 retractable shelf for tool cases complete with tool cases and boxes



Suitable to be installed in the zone: **2a**

**Order no. MDL 123**

Dimensions: **1225x365x1700 mm** (WxDxH)

Weight: **54,65 Kg**

Module complete with:

- 4 trays with rubber and 16 adjustable dividers
- 1 shelf with door
- 1 connection bar with fixing belts for tool cases

\*approximate measurement

**Technical features, see page 5**  
**Accessories see page 9**

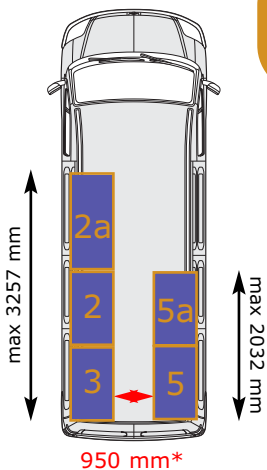

**Order no. SFM 250**

Fixing bar: **2500x30x35 mm** (WxDxH)

Weight: **2,2 Kg**

Fixing bar for modules, complete with brackets, bolts and screws.

**The bar is necessary to fix the modules to the vehicle.**

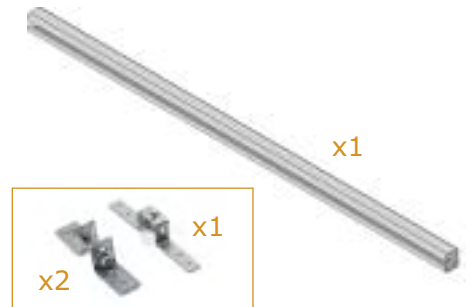

**Order no. SFM 350**

Fixing bar: **3500x30x35 mm** (WxDxH)

Weight: **2,93 Kg**

Fixing bar for modules, complete with brackets, bolts and screws.

**The bar is necessary to fix the modules to the vehicle.**

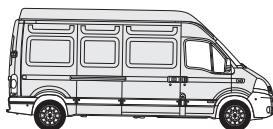
**FLOORINGS AND LININGS**

for MASTER with RH side sliding door and rear leaf doors, sheet metal side walls

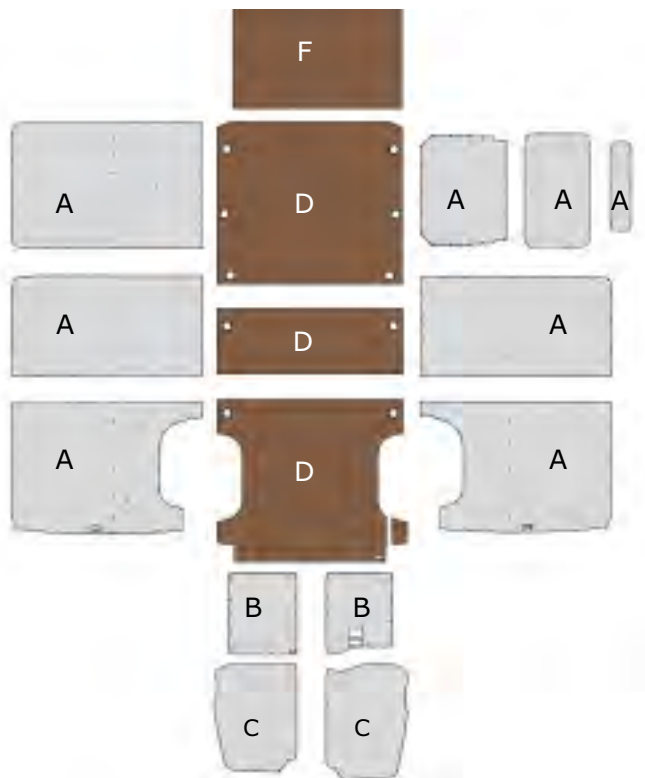
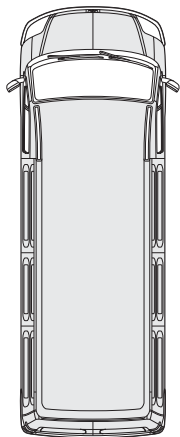
**A + B Polypropylene linings**  
**Art. PAN 208**

 Weight : **22,80 Kg**
**Polypropylene linings for:**

- LH side wall
- RH side wall and sliding door
- lower section of rear leaf doors

 Technical  
 features,  
 see page 5

**C Polypropylene linings**  
**Art. PAR 206**

 Weight : **2,85 Kg**
**Polypropylene linings for:**

- upper section of rear leaf doors

**D Flooring**  
**Art. PIL 211**

 Weight : **51,40 Kg**
**12 mm thick wooden flooring phenolic coated** and predrilling for lashing hook supports.

**E Bulkhead**  
**Art. PIR 202**

 Weight : **12,55 Kg**
**12 mm wooden phenolic coated bulkhead panel.**



13,9 m<sup>3</sup>  
L3 H3 wheelbase 4078 mm



MOVANO Panel Van LWB  
Maxi roof

## LOADING RAMP

### Order no. RAM 202

Dimensions: **1250x2500 mm** (WxD)  
Weight: **118,85 Kg**

Swivel loading ramp.

Load capacity: **1000 Kg** (p.u.d.)



Technical  
features,  
see page 8

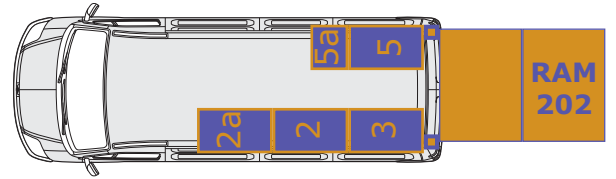

The swivel loading ramp can be installed also when the modules are fitted.

If the loading ramp is fitted, the MDL modules for the areas **2, 2a** and **3** must not be longer than 1016 mm.

If the loading ramp is fitted, the MDL modules for the areas **5a** must not be longer than 508 mm.

If the loading ramp is installed the article **MDL 164 cannot be installed** in area **5**.

It is advisable to ask your nearest STORE VAN distributor for a project feasibility study.

## READY SOLUTIONS



### Order no. MDL S26

Dimensions: **3048x365x1700 mm** (WxDxH). Weight: **100,68 Kg**

Set of 2 modules complete with:

- 10 trays with rubber and 38 adjustable dividers
- 1 fixing bar length 3500 mm



### Order no. MDL S27

Dimensions: **2032x365x1700 mm** (WxDxH). Weight: **105,30 Kg**

Module complete with:

- 10 trays with rubber and 30 adjustable dividers
- 2 drawers
- 1 shelf with door
- 1 hinged door
- 1 fixing bar length 2500 mm

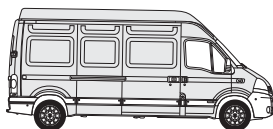

## MODULES 1016 MM

Suitable to be installed in the zone: **3** **5****Order no. MDL 161**Dimensions: **1016x365x1700 mm** (WxDxH)Weight: **61,38 Kg**

Module complete with:

- 4 trays with rubber and 12 adjustable dividers
- 2 drawers
- 1 shelf with door
- 1 hinged door

Suitable to be installed in the zone: **3** **5****Order no. MDL 162**Dimensions: **1016x365x1700 mm** (WxDxH)Weight: **58,07 Kg**

Module complete with:

- 5 trays with rubber and 15 adjustable dividers
- 1 drawer
- 1 retractable shelf for tool cases complete with tool cases and boxes

Suitable to be installed in the zone: **3** **5****Order no. MDL 163**Dimensions: **1016x365x1700 mm** (WxDxH)Weight: **40,20 Kg**

Module complete with:

- 6 trays with rubber and 18 adjustable dividers

Suitable to be installed in the zone: **2** **2a** **5a****Order no. MDL 114**Dimensions: **1016x365x1700 mm** (WxDxH)Weight: **62,90 Kg**

Module complete with:

- 4 trays with rubber and 12 adjustable dividers
- 2 drawers
- 1 shelf with door
- 1 hinged door

Suitable to be installed in the zone: **5****Order no. MDL 164**Dimensions: **1016x365x1700 mm** (WxDxH)Weight: **64,40 Kg**

Module complete with:

- 6 trays with rubber and 18 adjustable dividers
- 1 retractable vice workbench complete with steel vice with 100 mm jaws and 1/2" to 1 1/2" pipe clamp

Suitable to be installed in the zone: **2** **2a** **5a****Order no. MDL 116**Dimensions: **1016x365x1700 mm** (WxDxH)Weight: **46,70 Kg**

Module complete with:

- 6 trays with rubber and 18 adjustable dividers

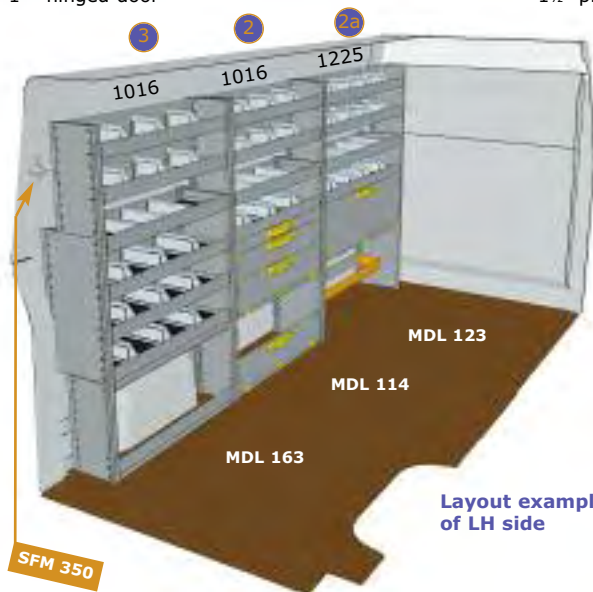
Layout example  
of LH sideLayout example  
of RH side

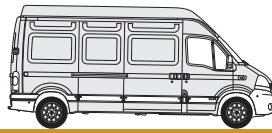

**MODULES 1016 MM**



Suitable to be installed in the zone: **2 2a 5a**

**Order no. MDL 115**

Dimensions: **1016x365x1700 mm** (WxDxH)

Weight: **61,80 Kg**

Module complete with:

- 5 trays with rubber and 15 adjustable dividers
- 1 drawer
- 1 retractable shelf for tool cases complete with tool cases and boxes



Suitable to be installed in the zone: **2 2a 5a**

**Order no. MDL 117**

Dimensions: **1016x365x1700 mm** (WxDxH)

Weight: **46,50 Kg**

Module complete with:

- 4 trays with rubber and 12 adjustable dividers
- 1 shelf with door
- 1 connection bar with fixing belts for tool cases

**MODULES 1225 MM**



Suitable to be installed in the zone: **2a**

**Order no. MDL 120**

Dimensions: **1225x365x1700 mm** (WxDxH)

Weight: **72,95 Kg**

Module complete with:

- 4 trays with rubber and 16 adjustable dividers
- 2 drawers
- 1 shelf with door
- 1 hinged door



Suitable to be installed in the zone: **2a**

**Order no. MDL 122**

Dimensions: **1225x365x1700 mm** (WxDxH)

Weight: **55,00 Kg**

Module complete with:

- 6 trays with rubber and 24 adjustable dividers



Suitable to be installed in the zone: **2a**

**Order no. MDL 121**

Dimensions: **1225x365x1700 mm** (WxDxH)

Weight: **70,95 Kg**

Module complete with:

- 5 trays with rubber and 20 adjustable dividers
- 1 drawer
- 1 retractable shelf for tool cases complete with tool cases and boxes



Suitable to be installed in the zone: **2a**

**Order no. MDL 123**

Dimensions: **1225x365x1700 mm** (WxDxH)

Weight: **54,65 Kg**

Module complete with:

- 4 trays with rubber and 16 adjustable dividers
- 1 shelf with door
- 1 connection bar with fixing belts for tool cases

\*approximate measurement

Technical features, see page 5

Accessories see page 9

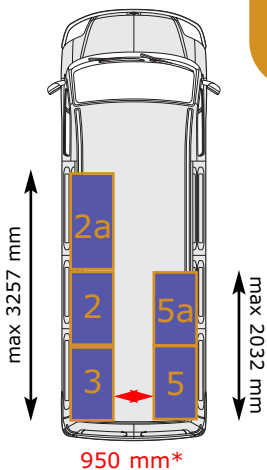

**Order no. SFM 250**

Fixing bar: **2500x30x35 mm** (WxDxH)

Weight: **2,2 Kg**

Fixing bar for modules, complete with brackets, bolts and screws.

**The bar is necessary to fix the modules to the vehicle.**

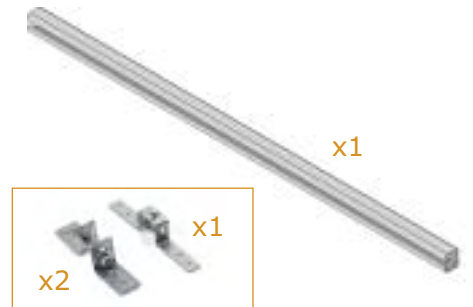

**Order no. SFM 350**

Fixing bar: **3500x30x35 mm** (WxDxH)

Weight: **2,93 Kg**

Fixing bar for modules, complete with brackets, bolts and screws.

**The bar is necessary to fix the modules to the vehicle.**



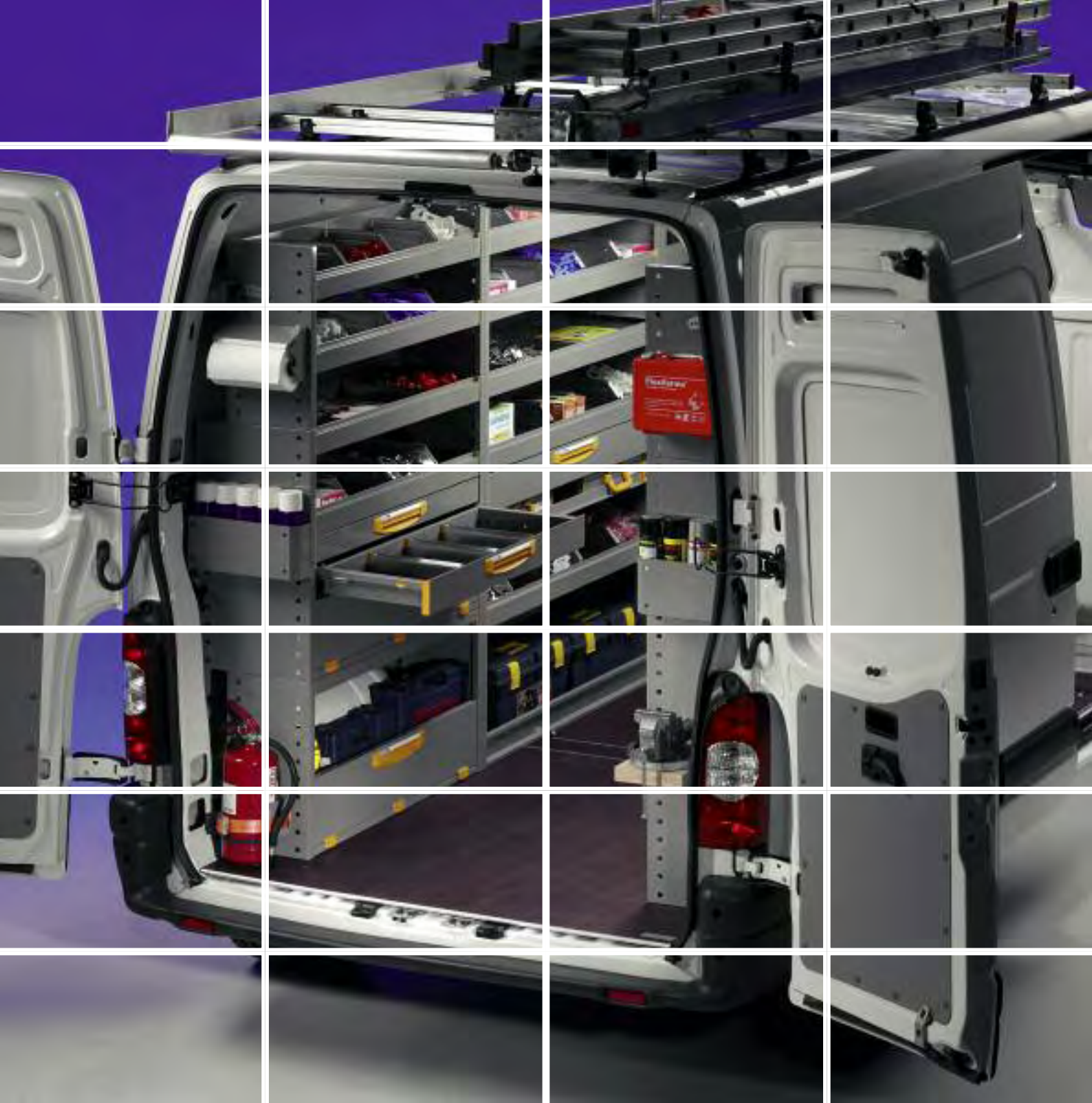

**FAMI S.r.l.**  
 Via Stazione Rossano, 13  
 36027 Rosà, Vicenza ITALY  
 Tel. +39 0424 585554  
 Fax +39 0424 585482  
 www.storevan.com  
 info@storevan.com

YOUR STOREVAN PARTNER



**PROFESSIONALITY  
 IN MOVEMENT**