

Fittings for commercial vehicles

Peugeot



PROFESSIONALITY IN MOVEMENT

TERMS OF SUPPLY

- Floorings and linings supplied in several parts.
- Floorings, linings, roof racks and ladder racks are supplied **unassembled**.
- Modules are supplied **pre-assembled** complete with fixing material to the vehicle.
- For **product installation** we suggest to contact the expert assistance of our network of **authorised installation centers** (see back cover).
- The products are supplied including **packing**.
- Our products are covered by a **3-years warranty**.
- **Load capacity** data refer to **uniformly distributed loads** (p.u.d.)

CERTIFIED PRODUCTION

Successfully certified, Quality Assurance Certification since over ten years.



CRASH TEST STORE VAN



Passed the **CRASH TEST** carried out according to the recent European regulations. **ECE-R17** with impact at **50 Km/h**.

TESTED AND CERTIFIED SAFETY



STORE VAN has obtained the prestigious **GS** certification for its loading ramps and interior fittings.



STORE VAN also boasts the rare **GS** certification for the universal ladder rack.

Store Van

A TRADEMARK OF FAMI'S GROUP

Fami's constant focus on the market trends, combined with studies for customized products, has been the winning strategy also for the last born brand name – STORE VAN - which offers fittings for commercial vehicles of all types. The accurate designed modules and the perfect adaptability for the most different personalised projects, confirmed the quality and supremacy of Store Van's components.

The achieved success allowed Store Van to become one of the most reliable and popular supplier among the international commercial vehicles producers.



PROFESSIONALITY IN MOVEMENT

Store Van first introduced an innovative installation system without drilling the van bodyworks to fix the equipments, guaranteeing functionality, quality, steadiness and aesthetic features, both for estate cars and for large vans and fleets.

LOGISTIC QUALITY SYSTEMS









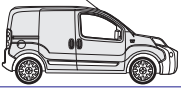
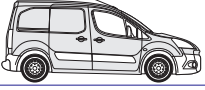

Fami's strategy develops through products versatility, while each project becomes exclusive and customised. This strategy, along with advanced industrial processes, originates fitting systems suitable to meet all customers' requirements.

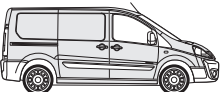
Fami, one of the leading Company in the field of industrial storage systems, gives priority to the technological features but also considers the design and the "soul" of the product, signing each article with a perfect balance of technology and "heart".

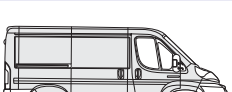

Fami stands out for its high technology and original solutions, like industrial storage, work stations and conductive systems for the electronic industry. All Company's advanced solutions can be employed and diversified in different applications, becoming Fami the leading Company in its field as far competence and competitiveness.

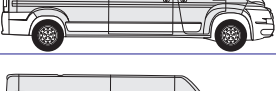
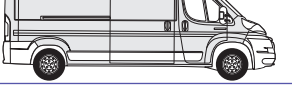

	MODEL	VEHICLE DATA	PAGE
	Bipper panel van	2,5 m³ L1 H1 wheelbase 2513 mm height 1721 mm	15-22
	Partner panel van L1 2008	3,3/3,7 m³ L1 H1 wheelbase 2728 mm height 1812-1834 mm	27-34
	Partner panel van L2 2008	3,7/4,1 m³ L1L H1 wheelbase 2728 mm height 1832 mm	35-36
	Expert - L1 H1 panel van Short low van	5 m³ L1 H1 wheelbase 3000 mm height 1980 mm	41-44
	Expert - L2 H1 panel van Long low van	6 m³ L2 H1 wheelbase 3122 mm height 1980 mm	45-48
	Expert - L2 H2 panel van Long tall van	7 m³ L2 H2 wheelbase 3122 mm height 2290 mm	49-50
	Boxer - L1 H1 panel van	8 m³ L1 H1 wheelbase 3000 mm height 2254 mm	55-58
	Boxer - L2 H1 panel van	10 m³ L2 H1 wheelbase 3450 mm height 2254 mm	59-62
	Boxer - L2 H2 panel van	11,5 m³ L2 H2 wheelbase 3450 mm height 2524 mm	63-66
	Boxer - L3 H2 panel van	13 m³ L3 H2 wheelbase 4035 mm height 2524 mm	67-70
	Boxer - L3 H3 panel van	15 m³ L3 H3 wheelbase 4035 mm height 2764 mm	71-74
	Boxer - L4 H2 panel van	15 m³ L3L H2 wheelbase 4035 mm height 2524 mm	75-78
	Boxer - L4 H3 panel van	17 m³ L3L H3 wheelbase 4035 mm height 2764 mm	79-82

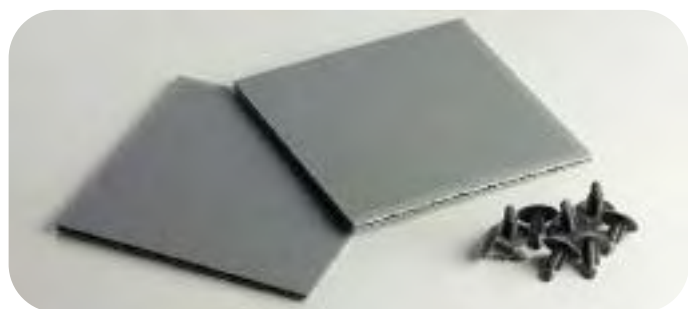

LININGS

4 mm thick polypropylene honeycomb linings with scratchproof surface. Lightweight and robust.



FLOORINGS

Pre-shaped loading floors in one or more jointed pieces with extruded aluminium inserts. Made of 12 mm thick birch and conifer phenolic multi-ply, resin-bonded on both faces and a wear-resistant and slip-proof surface treatment.



DRAWERS

Easy and intuitive one hand opening with handle operated opening and closing safety stop. Wide range of dividing options of the drawers by means of plastic or metal accessories.

Load capacity: 50 Kg



RETRACTABLE SHELVES

Retractable shelves for one or two tool cases with the possibility of introducing tool cases with different heights and depths.

Load capacity: 50 Kg



VICE WORKBENCHES

Retractable vice workbench complete with steel vice, swivel base, jaws width 100 mm.

Technical features

TALENTO ladder rack rails
with **lowering system** with brake for ladders weight up to 60 kg.



ALADIN ladder rack rails
with **servo-assisted lowering and lifting system** for ladders weight up to 60 kg.



LOADING RAMPS



Servo assisted loading ramps with tubular steel structure and knurled slip-proof aluminium platform. Connection to the vehicle by means of a telescopic column and self-positioning feet.

Load capacity from: 600 to 1500 Kg.

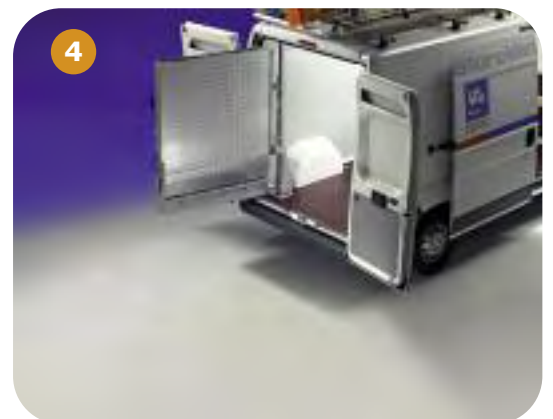
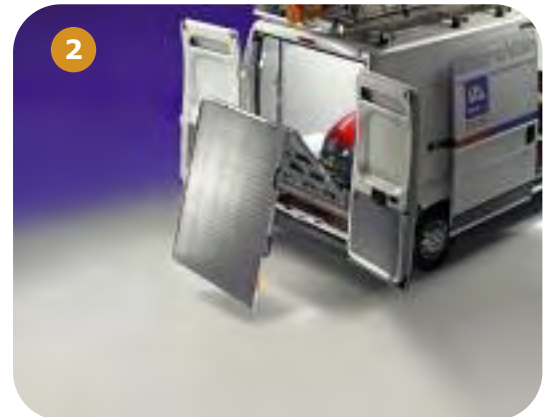

292 mm DEEP TOOL CASES

**Order no. VAL 001****Case with boxes**

Dim. 438x292x67 mm (WxDxH)
Internal solutions with:
2 green, 2 blue, 5 yellow,
10 red boxes.

**Order no. VAL 002****Case with boxes**

Dim. 438x292x67 mm (WxDxH)
Internal solutions with: 8 blue,
8 red boxes.

**Order no. VAL 003****Case with boxes**

Dim. 438x292x102 mm (WxDxH)
Internal solutions with: 2 blue,
2 green, 5 yellow, 10 red boxes.
Upper tray with 20 red and
10 yellow boxes.

**Order no. VAL 004****Case with boxes**

Dim. 438x292x102 mm (WxDxH)
Internal solutions with:
4 green, 4 blue boxes.
Upper tray with 20 red and 10 yellow boxes.

343 mm DEEP TOOL CASES

**Order no. VAL 005****Case with boxes**

Dim. 438x343x67 mm (WxDxH)
Internal solutions with:
2 green, 3 blue, 6 yellow,
12 red boxes.

**Order no. VAL 006****Case with boxes**

Dim. 438x343x67 mm (WxDxH)
Internal solutions with:
8 green boxes.

**Order no. VAL 007****Case with boxes**

Dim. 438x343x102 mm (WxDxH)
Internal solutions with:
2 green, 3 blue, 6 yellow, 12 red
boxes. Upper tray with 24 red and
12 yellow boxes.

**Order no. VAL 008****Case with boxes**

Dim. 438x343x102 mm (WxDxH)
Internal solutions with:
12 blue boxes.
Upper tray with 24 red and 12 yellow boxes.

ACCESSORIES FOR MODULES



Order no. ACS 001
Hand washing kit



Order no. ACS 002
Can holder kit with 20
litres capacity metal can



Order no. ACS 003
Supports with belt
strap for gas cylinders
and extinguishers



Order no. ACS 004
First aid kit



Order no. ACS 005
Paper towel holder kit
with paper towel
Ø 140 mm



Order no. ACS 006
DIN A4 document
holder



Order no. ACS 007
Spray-can holder kit



Order no. ACS 008
Painted aluminium
cable saddles

LOAD RETAINING BARS AND BELTS



Load retaining bar kit available in 3 dimensions:

Order no. ACS 009
Load retaining bar length 1000 mm
Pair of polyester belts length 3260 mm

Order no. ACS 010
Load retaining bar length 1500 mm
Pair of polyester belts length 3260 mm

Order no. ACS 011
Load retaining bar length 2000 mm
Pair of polyester belts length 3260 mm

CRANES



Revolving crane with positioning brake and folding arm. Including 12 V motor and lifting hook sliding on an aluminium guide and electric limit switch, equipped with remote control with cable.

Load capacity from: 150 to 190 Kg.

OPTIONAL ACCESSORY NOT AVAILABLE FOR ALL VEHICLES MODELS

COMPRESSORS AND RETRACTABLE HORIZONTAL SYSTEMS



Retractable horizontal aluminium frames. Mechanical stop of the frame in opening and closing.

Possibility of blocking the shelf in any opening position.

Load capacity: 300 Kg

Extraction: 60%

Vertical compressors 220V - 380V.

Capacity: 50 - 100 LT



COLLAPSIBLE VICE WORKBENCHES



Collapsible vice workbenches with floor support.
Work bench height adjustable.

Top width: 240 / 340 mm

Depth: 1150 mm



LIFTING DOORS



Lifting doors with assisted opening.

Width: 508 / 717 / 1016 / 1225 / 1524 mm

Useful height: 350 / 400 mm



SHELVES



Shelves available for modules:

Length: 508 / 717 / 1016 / 1225 / 1524 mm

Depth: 265 / 365 mm

Front height: 35 mm

Back height: 100 mm

Available with or without polypropylene containers

Strategically strong



Bipper L1 H1 - 2,8 m³

Vehicle equipped with:

1	ord. no. POS 009	roof rack
1	ord. no. PIL 010	wooden flooring
1	ord. no. PAN 013	polypropylene lining
1	ord. no. PAR 006	polypropylene lining
1	ord. no. MDL 053	module
1	ord. no. MDL 054	module
1	ord. no. ACS 007	spray cans holder kit
1	ord. no. ACS 004	first aid kit
1	ord. no. ACS 008	painted aluminium cable saddles

- › **FAST ASSEMBLY**
- › **TOTAL MODULARITY**
- › **SAFETY SOUND ABSORBING ELEMENTS BETWEEN THE VARIOUS METAL COMPONENTS**
- › **ERGONOMETRIC SHAPES**
- › **HEIGHT ADJUSTMENT IN PITCH OF 25 mm OF THE VARIOUS ELEMENTS**



BIPPER



FLOORINGS AND LININGS

for BIPPER with RH side sliding door and rear leaf doors, sheet metal side walls

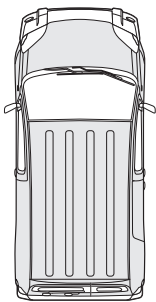

Technical features, see page 5

A Polypropylene linings
Order no. PAN 013

Weight: 1,88 Kg

Polypropylene linings for:

- LH side wall
- RH side wall and sliding door

C Polypropylene linings
Order no. PAR 006

Weight: 0,88 Kg

Polypropylene linings for:

- upper section of rear leaf doors

D Flooring for sheet steel bulkhead (1)
Order no. PIL 009

Weight: 14,90 Kg

12 mm thick wooden flooring phenolic coated and predrilling for lashing hook supports.

F Bulkhead for sheet steel bulkhead (1)
Order no. PIR 004

Weight: 3,40 Kg

12 mm wooden phenolic coated bulkhead panel.

E Flooring for closing mesh bulkhead (2)
Order no. PIL 010

Weight: 17,54 Kg

12 mm thick wooden flooring phenolic coated and predrilling for lashing hook supports.

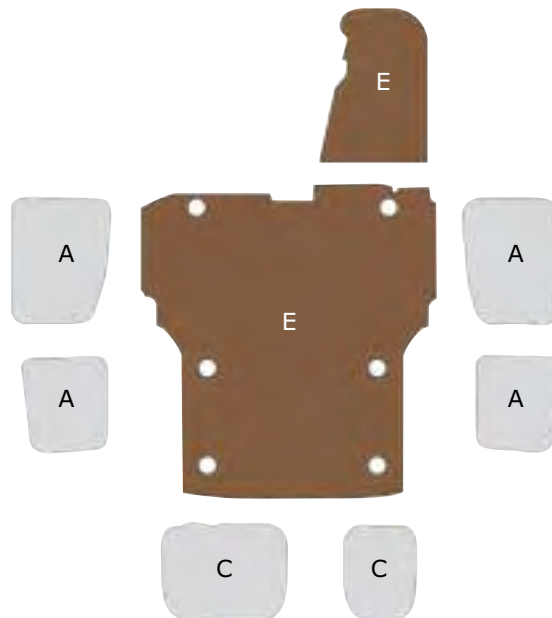
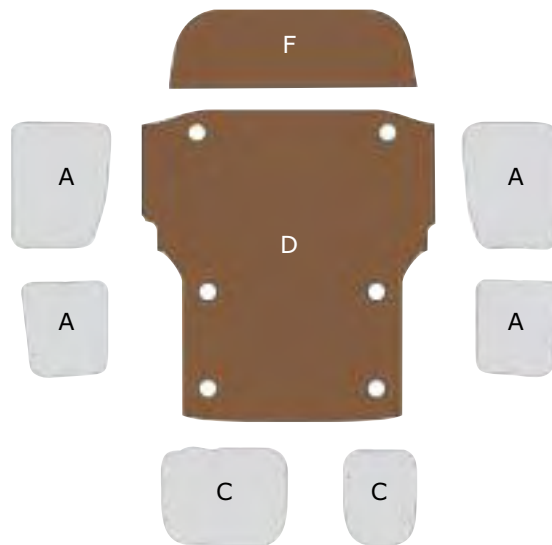

ROOF RACK



ROOF RACK only for Bipper with rear leaf doors

LADDER RACK

The ladder rack rail can be mounted on the right or on the left hand side of the vehicle



LADDER RACK only for Bipper with rear leaf doors

Technical features, see page 7

Order no. POT 009

Dimensions: 2000x1400 mm (WxD)

Weight: 20,20 Kg

Roof rack complete with:

- 3 aluminium crossmembers with fixing connectors and rubber profile
- 2 2000 mm long aluminium side upstands
- 1 aluminium loading roller

Supplied with stainless steel screws for fixing.

Load capacity: 80 Kg (p.u.d.)

Order no. POS 012

Dimensions: 2110x1380 mm (WxD)

Weight: 42,40 Kg

Ladder rack complete with:

- 3 aluminium crossmembers with fixing connectors and rubber profile
- 1 2000 mm long aluminium side upstand
- 1 aluminium loading roller
- 1 ladder rack rail made from stainless steel and aluminium TALENTO series, length 2110 mm

Supplied with stainless steel screws for fixing.

Load capacity: 58 Kg (p.u.d.)



Technical features, see page 5
Accessories see page 9

*approximate measurement

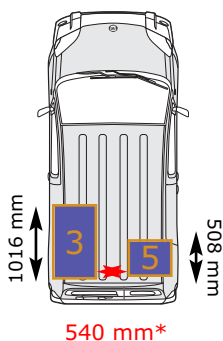

Layout example of LH side



Layout example of RH side



Suitable to be installed in the zone: 3

Order no. MDL 051

Dimensions: **1016x365x900 mm** (WxDxH)
Weight: **45,50 Kg**

Module complete with:

- 3 trays with rubber and 5 adjustable dividers
- 3 drawers
- 1 hinged door



Suitable to be installed in the zone: 3

Order no. MDL 052

Dimensions: **1016x365x900 mm** (WxDxH)
Weight: **27,70 Kg**

Module complete with:

- 3 trays with rubber and 9 adjustable dividers



Suitable to be installed in the zone: 3

Order no. MDL 053

Dimensions: **1016x365x900 mm** (WxDxH)
Weight: **44,30 Kg**

Module complete with:

- 3 trays with rubber and 5 adjustable dividers
- 3 shelves for tool cases complete with tool cases and boxes
- 1 hinged door



Suitable to be installed in the zone: 5

Order no. MDL 054

Dimensions: **508x365x900 mm** (WxDxH)
Weight: **32,30 Kg**

Module complete with:

- 1 tray with rubber and 1 adjustable divider
- 3 drawers
- 1 hinged door



Suitable to be installed in the zone: 5

Order no. MDL 055

Dimensions: **508x365x900 mm** (WxDxH)
Weight: **18,30 Kg**

Module complete with:

- 3 trays with rubber and 3 adjustable dividers



Suitable to be installed in the zone: 5

Order no. MDL 056

Dimensions: **508x365x900 mm** (WxDxH)
Weight: **29,95 Kg**

Module complete with:

- 1 tray with rubber and 1 adjustable divider
- 3 shelves for tool cases complete with tool cases and boxes
- 1 hinged door



DOUBLE LEVEL FLOOR

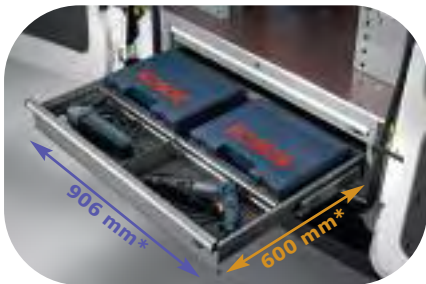

Detail of the two fully-extending telescopic drawers complete with separation material.

*Useful interior dimensions

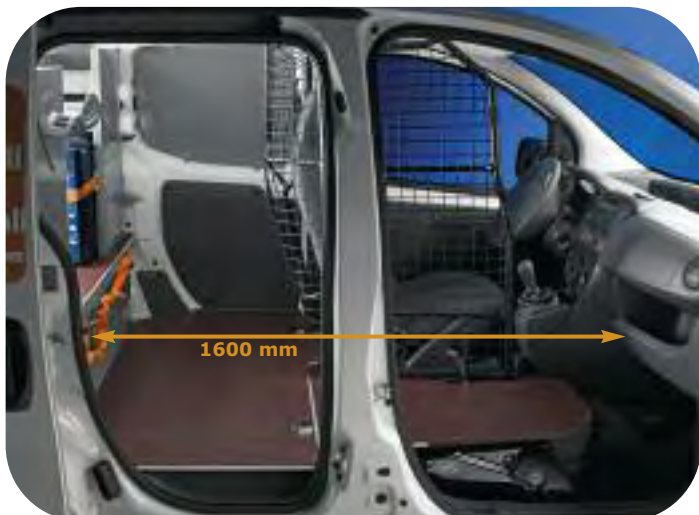
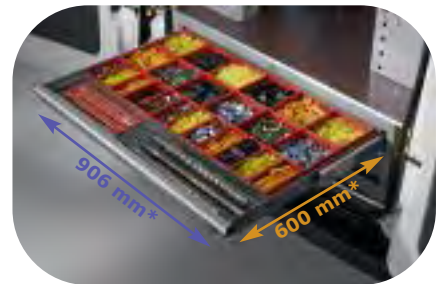

Detail of the double level floor kit with two rear modules

2,5 m³
L1 H1 wheelbase 2513 mm



*Useful interior dimensions

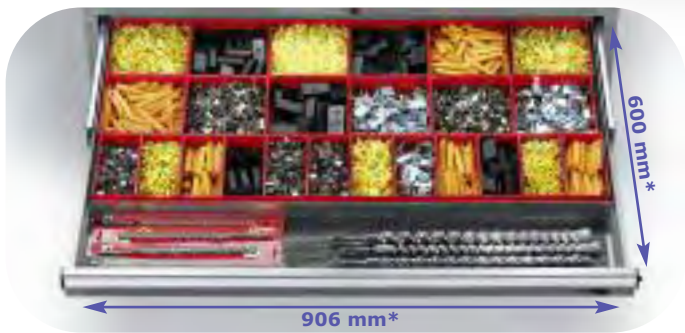

Detail of the drawer with a useful height of 54 mm supplied as standard with: 2 dividers, 24 divider trays. Tools not included.



Detail of the drawer with a useful height of 104 mm supplied as standard with: 2 dividers. Tools not included



Detail of the strap with load fastening hooks supplied as standard with the double level floor kit.

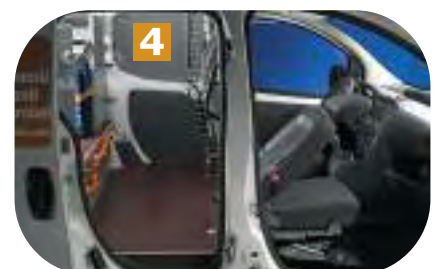
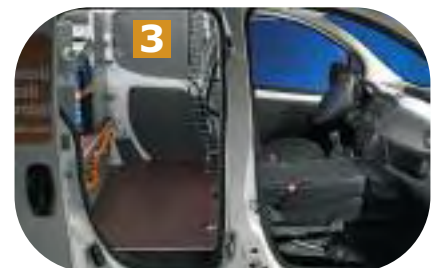
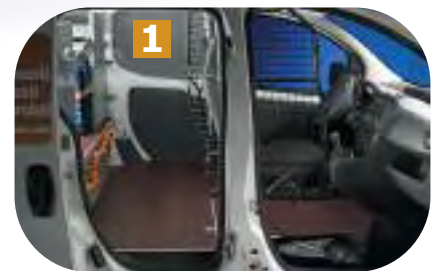

Detail of the closing mesh bulkhead and the removable floor for bucket seats



1 Double level floor kit for closing mesh bulkhead (2)

Order no. MPR 001

Dimensions: **1482x1395x324 mm** (WxDxH)

Weight: **100,00 Kg**

Kit complete with:

- 1 **lower** wooden floor with a 12 mm thickness with phenolic coating **for closing mesh bulkhead**
- 1 **upper** wooden floor with a 12 mm thickness with phenolic coating
- 1 drawer unit with 2 drawers complete with separation material. Internal dimensions of the drawer 906x600x54/104 mm h



2 Module

Order no. MDL 057

Dimensions: **508x365x700 mm** (WxDxH)

Weight: **15,40 Kg**

Module complete with:

- 1 tray with rubber and 1 adjustable divider
- 1 shelf for tool case complete with tool case and boxes
- 1 connection bar with fixing belts for tool cases

3 Module

Order no. MDL 058

Dimensions: **508x365x650 mm** (WxDxH)

Weight: **21,60 Kg**

Module complete with:

- 1 tray with rubber and 1 adjustable divider
- 2 shelves for tool cases complete with tool cases and boxes
- 1 hinged door



Drawers,
see page 18



4 Module

Order no. MDL 059

Dimensions: **508x365x700 mm** (WxDxH)

Weight: **13,35 Kg**

Module complete with:

- 2 trays with rubber and 2 adjustable dividers
- 1 connection bar with fixing belts for tool cases



5 Module

Order no. MDL 060

Dimensions: **508x365x650 mm** (WxDxH)

Weight: **13,60 Kg**

Module complete with:

- 2 trays with rubber and 2 adjustable dividers
- 1 hinged door



6 Double level floor kit for sheet steel bulkhead (1)

Order no. MPR 002

Dimensions: **1482x1395x324 mm** (WxDxH)

Weight: **97,30 Kg**

Kit complete with:

- 1 **lower** wooden floor with a 12 mm thickness with phenolic coating **for sheet steel bulkhead**
- 1 **upper** wooden floor with a 12 mm thickness with phenolic coating
- 1 drawer unit with 2 drawers complete with separation material. Internal dimensions of the drawer 906x600x54/104 mm h

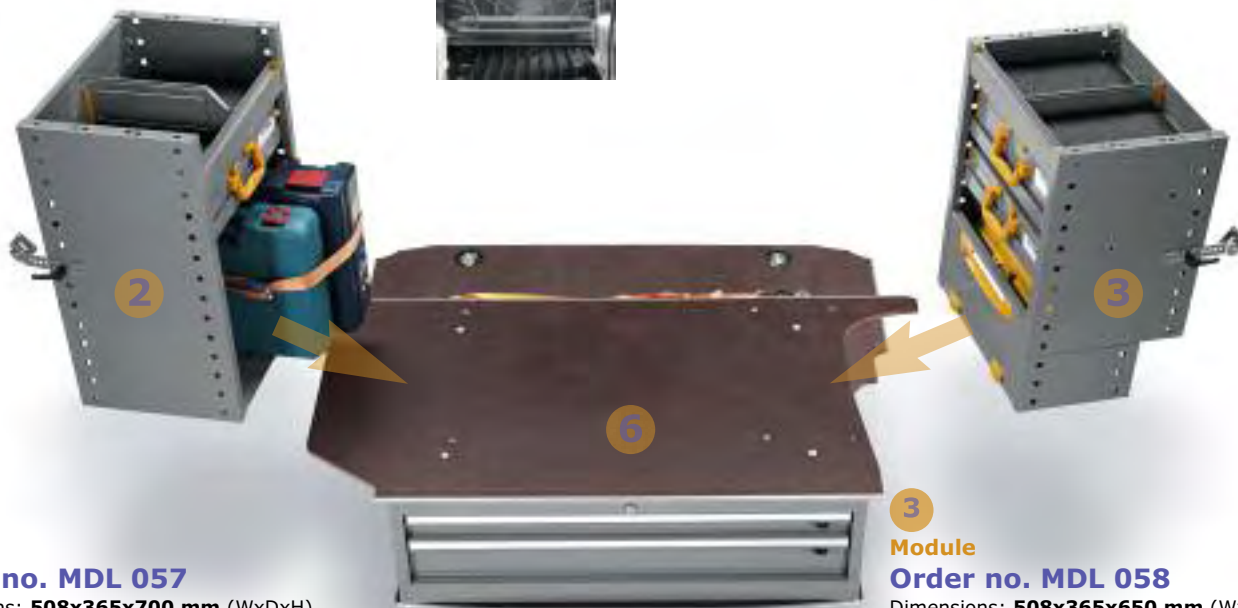

2 Module

Order no. MDL 057

Dimensions: **508x365x700 mm** (WxDxH)

Weight: **15,40 Kg**

Module complete with:

- 1 tray with rubber and 1 adjustable divider
- 1 shelf for tool case complete with tool case and boxes
- 1 connection bar with fixing belts for tool cases

3 Module

Order no. MDL 058

Dimensions: **508x365x650 mm** (WxDxH)

Weight: **21,60 Kg**

Module complete with:

- 1 tray with rubber and 1 adjustable divider
- 2 shelves for tool cases complete with tool cases and boxes
- 1 hinged door



Drawers, see page 18



4 Module

Order no. MDL 059

Dimensions: **508x365x700 mm** (WxDxH)

Weight: **13,35 Kg**

Module complete with:

- 2 trays with rubber and 2 adjustable dividers
- 1 connection bar with fixing belts for tool cases

5 Module

Order no. MDL 060

Dimensions: **508x365x650 mm** (WxDxH)

Weight: **13,60 Kg**

Module complete with:

- 2 trays with rubber and 2 adjustable dividers
- 1 hinged door



HORIZONTAL RETRACTABLE SYSTEMS



940 mm

Horizontal retractable system for sheet steel bulkhead (1)

Order no. PEO 002

Dimensions: **1225x890x80 mm** (WxDxH)

Weight: **53,80 Kg**

System complete with:

- 1 wooden flooring phenolic coated with holes for fixing the extractable frame
- 1 horizontal extractable frame extension 60% load capacity 300 Kg complete with a shelf in phenolic wooden top and rubber protection
- 8 lashing hooks supports for load retaining belt
- 2 load retaining belts



Horizontal retractable system for closing mesh bulkhead (2)

Order no. PEO 001

Dimensions: **1225x890x80 mm** (WxDxH)

Weight: **56,40 Kg**

System complete with:

- 1 wooden flooring phenolic coated with holes for fixing the extractable frame
- 1 horizontal extractable frame extension 60% load capacity 300 Kg complete with a shelf in phenolic wooden top and rubber protection
- 8 lashing hooks supports for load retaining belt
- 2 load retaining belts



The horizontal retractable system makes it easier to anchor the material transported and makes loading, unloading operations simpler



Strategically strong



Partner L1 H1 - 3,3/3,7 m³

- › **FAST ASSEMBLY**
- › **TOTAL MODULARITY**
- › **SAFETY SOUND ABSORBING ELEMENTS BETWEEN THE VARIOUS METAL COMPONENTS**
- › **ERGONOMIC SHAPES**
- › **HEIGHT ADJUSTMENT IN PITCH OF 25 mm OF THE VARIOUS ELEMENTS**

Vehicle equipped with:

- 1 ord. no. POS 011 roof rack
- 1 ord. no. PIL 011 wooden flooring
- 1 ord. no. PAN 014 polypropylene linings
- 1 ord. no. MDL 003 module
- 1 ord. no. MDL 007 module
- 1 ord. no. ACS 004 first aid kit
- 1 ord. no. ACS 007 spray cans holder kit
- 1 ord. no. ACS 003 support with belt for gas cylinders and extinguishers (extinguisher not supplied)



PARTNER





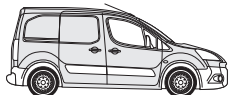

FLOORINGS AND LININGS

for PARTNER with RH side sliding door
and rear leaf doors, sheet metal side
walls

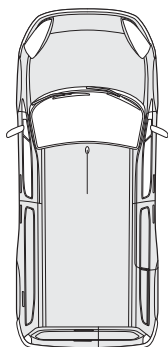

Technical
features,
see page 5

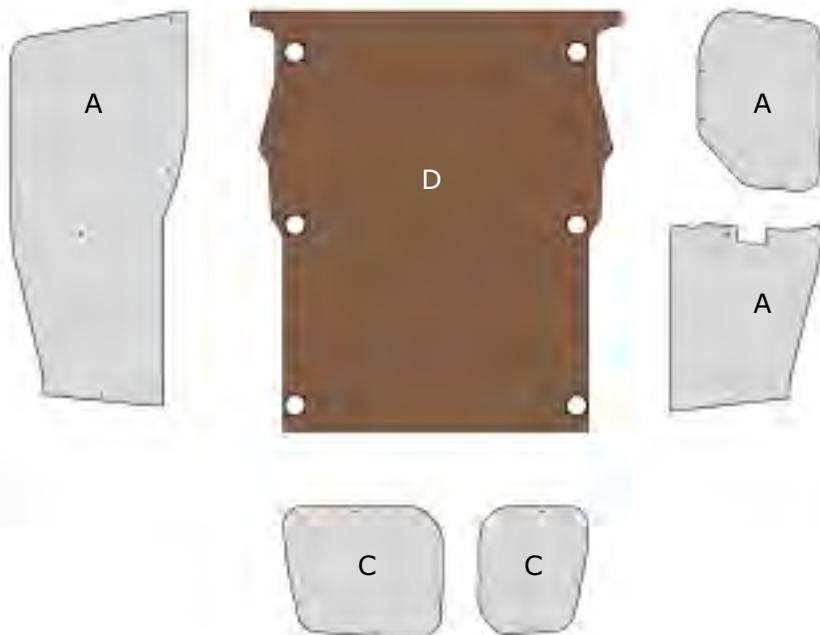

A Polypropylene linings
Order no. PAN 014

Weight: 3,05 Kg

Polypropylene linings for:

- LH side wall
- RH side wall and sliding door

B Polypropylene linings
Order no. PAR 007

Weight: 1,02 Kg

Polypropylene linings for:

- upper section of rear leaf doors

D Flooring
Order no. PIL 011

Weight: 17,65 Kg

12 mm thick wooden flooring phenolic
coated and predrilling for lashing hook sup-
ports.

ROOF RACK



Order no. POT 011

Dimensions: 2000x1400 mm (WxD)

Weight: 22,00 Kg

Roof rack complete with:

- 3 aluminium crossmembers with fixing connectors and rubber profile
- 2 2000 mm long aluminium side upstands
- 1 aluminium loading roller

Supplied with stainless steel screws for fixing.

Load capacity: 78 Kg (p.u.d.)

ROOF RACK only for Partner with rear leaf doors

LADDER RACK

The ladder rack rail can be mounted on the
right or on the left hand side of the vehicle



Technical
features,
see page 5

Order no. POS 013

Dimensions: 2110x1380 mm (WxD)

Weight: 43,55 Kg

Ladder rack complete with:

- 3 aluminium crossmembers with fixing connectors and rubber profile
- 1 2000 mm long aluminium side upstand
- 1 aluminium loading roller
- 1 ladder rack rail made from stainless steel and aluminium TALENTO series, length 2110 mm

Supplied with stainless steel screws for fixing.

Load capacity: 57 Kg (p.u.d.)

LADDER RACK only for Partner with rear leaf doors



Technical features, see page 5
Accessories see page 9



*approximate measurement



Layout example of LH side

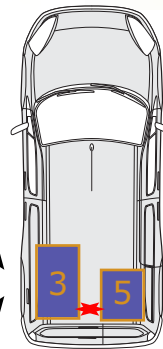

Layout example of RH side

Suitable to be installed in the zone: **3**

Order no. MDL 001

Dimensions: **1016x365x900 mm** (WxDxH)

Weight: **61 Kg**

Module complete with:

- 1 tray with rubber and 3 adjustable dividers
- 3 drawers
- 3 retractable shelves for tool cases complete with tool cases and boxes



Suitable to be installed in the zone: **3**

Order no. MDL 002

Dimensions: **1016x365x900 mm** (WxDxH)

Weight: **43,8 Kg**

Module complete with:

- 1 tray with rubber and 3 adjustable dividers
- 2 drawers
- 1 shelf with door
- 1 hinged door



Suitable to be installed in the zone: **3**

Order no. MDL 003

Dimensions: **1016x365x900 mm** (WxDxH)

Weight: **52,2 Kg**

Module complete with:

- 2 trays with rubber and 4 adjustable dividers
- 1 drawer
- 3 retractable shelves for tool cases complete with tool cases and boxes



Suitable to be installed in the zone: **3**

Order no. MDL 004

Dimensions: **1016x365x900 mm** (WxDxH)

Weight: **28,8 Kg**

Module complete with:

- 3 trays with rubber and 9 adjustable dividers



Suitable to be installed in the zone: **3 5**

Order no. MDL 005

Dimensions: **717x365x900 mm** (WxDxH)

Weight: **32,9 Kg**

Module complete with:

- 1 tray with rubber and 2 adjustable dividers
- 2 drawers
- 1 shelf with door



Suitable to be installed in the zone: **3 5**

Order no. MDL 006

Dimensions: **717x365x900 mm** (WxDxH)

Weight: **22,7 Kg**

Module complete with:

- 3 trays with rubber and 6 adjustable dividers



Suitable to be installed in the zone: **5**

Order no. MDL 007

Dimensions: **717x365x900 mm** (WxDxH)

Weight: **42,7 Kg**

Module complete with:

- 3 trays with rubber and 6 adjustable dividers
- 1 retractable vice workbench complete with steel vice with 100 mm jaws and 1/2" to 1 1/2" pipe clamp

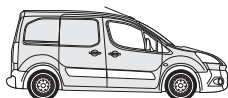

HORIZONTAL RETRACTABLE SYSTEMS DOUBLE LEVEL FLOOR WITH TRAPDOORS





The raised level with trapdoor allows for maximizing vehicle load volume by approx. 95% (1,2,3)



The space in the rear cab can be organised using a module with 2 trays (4,5)



An extractable horizontal system (6) complete with a module can be installed in the upper part of the level. This system still allows for use of the trapdoor adjacent to the sliding door (7)

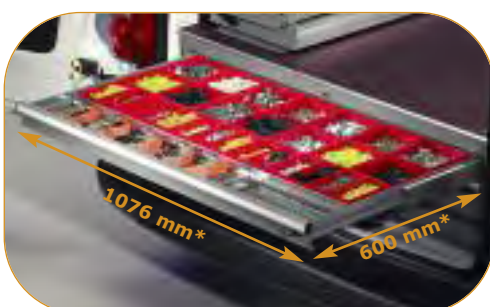

Detail of two full telescopic extension drawers complete of partitioning material (tools excluded).
Load capacity of each drawer:
150 Kg

*Useful interior dimensions

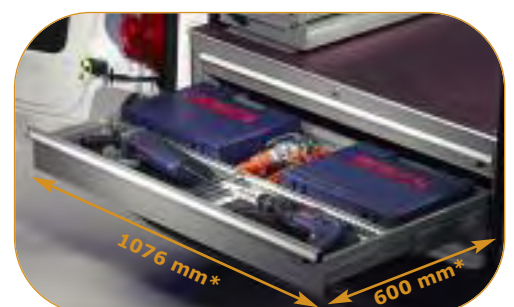

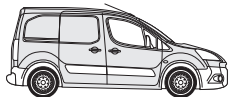

1 Double level floor kit

Order no. MPR 003

Dimensions: **1669x1470x328 mm** (WxDxH)

Weight: **109,30 Kg**

Kit complete with:

- 1 12 mm thick **lower** wooden flooring phenolic coated
- 1 12 mm thick **upper** wooden flooring phenolic coated
- 1 drawer cabinet with 2 drawers (load capacity 150 Kg each) complete of partitioning material, internal dimensions of the drawers 1076x600x54/104 mm h



2 Front frame for trapdoors

Order no. MPR 999

Dimensions: **1193x30x300 mm** (WxDxH)

Weight: **4,08 Kg**

Support for trapdoors in square tube 30x30 mm.



3 Trapdoor kit for vehicle with RH side door

Order no. MPR 004

Dimensions: **787x1356x12 mm** (WxDxH)

Weight: **11,50 Kg**

Kit complete with:

- 2 wooden trapdoors thickness 12 mm with phenolic coating and 6 hinges

Double level floor load capacity + trapdoor kit: **500 Kg (p.u.d.)**



4 Horizontal retractable system

Order no. PEO 202

Horizontal retractable system with module

Dimensions: **1225x365x740 mm** (WxDxH)

Weight: **39,00 Kg**

System complete with:

- 1 horizontal frame, extraction 60% load capacity 160 Kg
- 1 module with 3 trays with rubber and 12 adjustable partitions

THE HORIZONTAL RETRACTABLE SYSTEM

can only be mounted together with:

double level floor kit (1) + frame kit (2) + trapdoor kit (3).



Detail of extracted module





LAYOUT EXAMPLE No. 1

Complete with:

- 1 order no. **MPR 003** (1)
- 1 order no. **MPR 999** (2)
- 1 order no. **MPR 004** (3)



LAYOUT EXAMPLE No. 2

Complete with:

- 1 order no. **MPR 003** (1)
- 1 order no. **MPR 999** (2)
- 1 order no. **MPR 004** (3)
- 1 order no. **PEO 202** (4)



1 Double level floor kit

Order no. **MPR 003**

Dimensions: **1669x1470x328 mm** (WxDxH)

Weight: **109,30 Kg**

Kit complete with:

- 1 12 mm thick **lower** wooden flooring phenolic coated
- 1 12 mm thick **upper** wooden flooring phenolic coated
- 1 drawer cabinet with 2 drawers (load capacity 150 Kg each) complete of partitioning material, internal dimensions of the drawers 1076x600x54/104 mm h

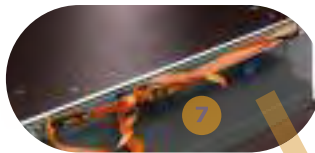

7 Kit load retaining belt

Order no. **MPR 997**

Dimensions: **4500x25 mm** (WxD)

Weight: **0,68 Kg**

Kit load retaining belt for double level floor without trapdoors.



5

Module

Order no. **MDL 059**

Dimensions: **508x365x700 mm** (WxDxH)

Weight: **13,35 Kg**

Module complete with:

- 2 trays with rubber and 2 adjustable dividers
- 1 connection bar with fixing belts for tool cases

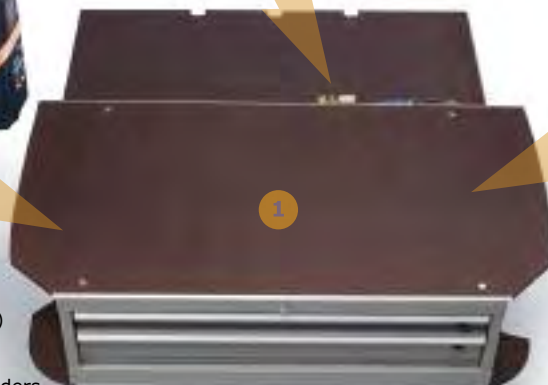

1



6

Module

Order no. **MDL 060**

Dimensions: **508x365x650 mm** (WxDxH)

Weight: **13,60 Kg**

Module complete with:

- 2 trays with rubber and 2 adjustable dividers
- 1 hinged door

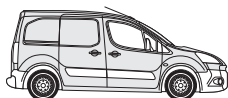

VERTICAL RETRACTABLE SYSTEMS



Vertical retractable system

Order no. PEV 001

Vertical retractable system with module

Dimensions: 1234x355x1110 mm (WxDxH)

Weight: 57,60 Kg

Panel complete with:

- 1 vertical frame, extraction 50% load capacity 100 Kg, extraction 70% load capacity 75 Kg
- 1 module with 4 trays with rubber and 16 adjustable dividers

THE VERTICAL RETRACTABLE SYSTEM can only be mounted together with the wooden flooring order no. PIL 011.



The vertical retractable system makes it easier to take out the stored material



Module

Order no. MDL 007

Dimensions: 717x365x900 mm (WxDxH)

Weight: 42,7 Kg

Module complete with:

- 3 trays with rubber and 6 adjustable dividers
- 1 retractable vice workbench complete with steel vice with 100 mm jaws and 1/2" to 1 1/2" pipe clamp



HORIZONTAL RETRACTABLE SYSTEMS



1000 mm

Horizontal retractable system

Order no. PEO 003

Dimensions: **1080x1524x80 mm** (WxDxH)

Weight: **70,80 Kg**

System complete with:

- 1 wooden flooring phenolic coated with holes for fixing the extractable frame
- 1 horizontal extractable frame extension 60% load capacity 300 Kg complete with a shelf in phenolic wooden top and rubber protection
- 8 lashing hooks supports for load retaining belt
- 2 load retaining belts



The horizontal retractable system makes it easier to anchor the material transported and makes loading, unloading operations simpler

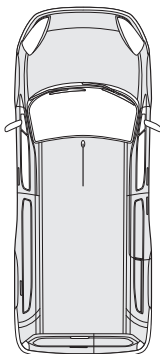

FLOORINGS AND LININGS

for PARTNER with RH side sliding door
and rear leaf doors, sheet metal side
walls

Technical
features,
see page 5

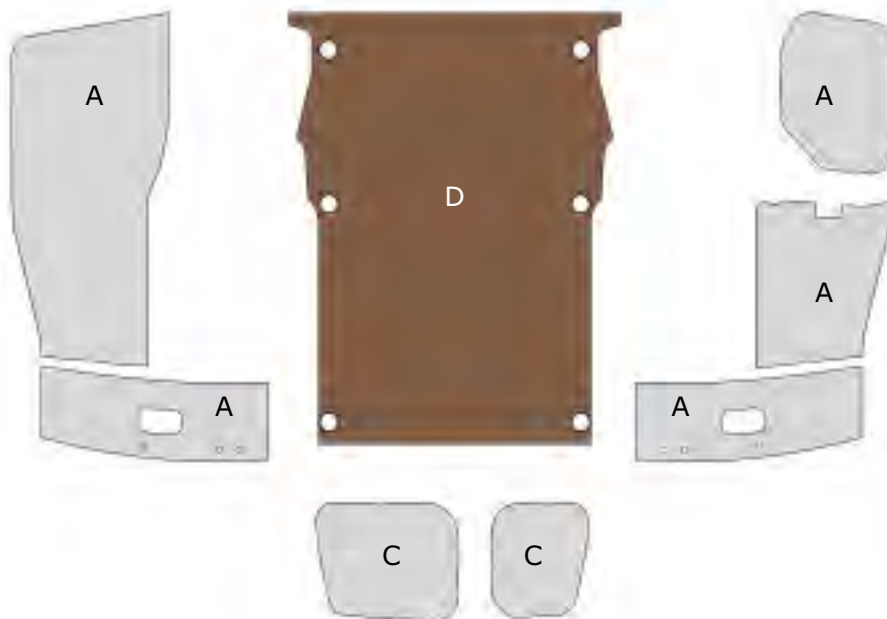

A Polypropylene linings Order no. PAN 015

Weight: **4,30 Kg**

Polypropylene linings for:

- LH side wall
- RH side wall and sliding door

C Polypropylene linings Order no. PAR 007

Weight: **1,02 Kg**

Polypropylene linings for:

- upper section of rear leaf doors

D Flooring Order no. PIL 012

Weight: **20,20 Kg**

12 mm thick wooden flooring phenolic coated and predrilling for lashing hook supports.

ROOF RACK



Order no. POT 012

Dimensions: **2500x1400 mm** (WxD)

Weight: **23,92 Kg**

Roof rack complete with:

- 3 aluminium crossmembers with fixing connectors and rubber profile
- 2 2500 mm long aluminium side upstands
- 1 aluminium loading roller

Supplied with **stainless steel** screws for fixing.

Load capacity: 76 Kg (p.u.d.)

ROOF RACK only for Partner with rear leaf doors

LADDER RACK

The ladder rack rail can be mounted on the right or on the left hand side of the vehicle



Technical
features,
see page 7

Order no. POS 014

Dimensions: **2650x1380 mm** (WxD)

Weight: **48,69 Kg**

Ladder rack complete with:

- 3 aluminium crossmembers with fixing connectors and rubber profile
- 1 2500 mm long aluminium side upstand
- 1 aluminium loading roller
- 1 ladder rack rail made from stainless steel and aluminium **TALENTO** series, length 2650 mm

Supplied with **stainless steel** screws for fixing.

Load capacity: 52 Kg (p.u.d.)

LADDER RACK only for Partner with rear leaf doors



Technical features, see page 5
Accessories see page 9

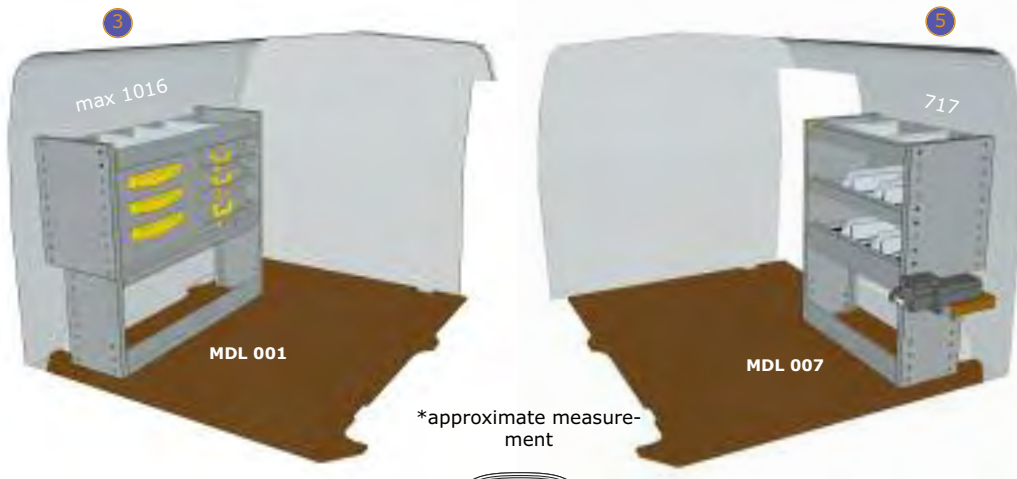

Layout example of LH side

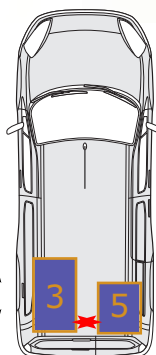

Layout example of RH side

Suitable to be installed in the zone: **3**

Order no. MDL 001

Dimensions: **1016x365x900 mm** (WxDxH)

Weight: **61 Kg**

Module complete with:

- 1 tray with rubber and 3 adjustable dividers
- 3 drawers
- 3 retractable shelves for tool cases complete with tool cases and boxes



Suitable to be installed in the zone: **3**

Order no. MDL 002

Dimensions: **1016x365x900 mm** (WxDxH)

Weight: **43,8 Kg**

Module complete with:

- 1 tray with rubber and 3 adjustable dividers
- 2 drawers
- 1 shelf with door
- 1 hinged door



Suitable to be installed in the zone: **3**

Order no. MDL 003

Dimensions: **1016x365x900 mm** (WxDxH)

Weight: **52,2 Kg**

Module complete with:

- 2 trays with rubber and 4 adjustable dividers
- 1 drawer
- 3 retractable shelves for tool cases complete with tool cases and boxes



Suitable to be installed in the zone: **3**

Order no. MDL 004

Dimensions: **1016x365x900 mm** (WxDxH)

Weight: **28,8 Kg**

Module complete with:

- 3 trays with rubber and 9 adjustable dividers

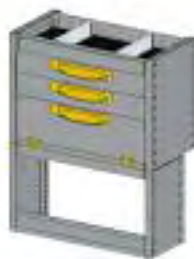

Suitable to be installed in the zone: **3 5**

Order no. MDL 005

Dimensions: **717x365x900 mm** (WxDxH)

Weight: **32,9 Kg**

Module complete with:

- 1 tray with rubber and 2 adjustable dividers
- 2 drawers
- 1 shelf with door



Suitable to be installed in the zone: **3 5**

Order no. MDL 006

Dimensions: **717x365x900 mm** (WxDxH)

Weight: **22,7 Kg**

Module complete with:

- 3 trays with rubber and 6 adjustable dividers



Suitable to be installed in the zone: **5**

Order no. MDL 007

Dimensions: **717x365x900 mm** (WxDxH)

Weight: **42,7 Kg**

Module complete with:

- 3 trays with rubber and 6 adjustable dividers
- 1 retractable vice workbench complete with steel vice with 100 mm jaws and 1/2" to 1 1/2" pipe clamp

Strategically strong



Expert L1 H1 - 5 m³

- > **FAST ASSEMBLY**
- > **TOTAL MODULARITY**
- > **SAFETY SOUND ABSORBING ELEMENTS BETWEEN THE VARIOUS METAL COMPONENTS**
- > **ERGONOMIC SHAPES**
- > **HEIGHT ADJUSTMENT IN PITCH OF 25 mm OF THE VARIOUS ELEMENTS**

Vehicle equipped with:

- | | | |
|---|------------------|---|
| 1 | ord. no. POS 003 | ladder rack (ladder not supplied) |
| 1 | ord. no. PIL 003 | wooden flooring |
| 1 | ord. no. PAN 003 | polypropylene linings |
| 1 | ord. no. PAR 002 | polypropylene linings (upper section of rear leaf doors) |
| 1 | ord. no. MDL 007 | module |
| 1 | ord. no. MDL 008 | module |
| 1 | ord. no. MDL 011 | module |
| 1 | ord. no. ACS 004 | first aid kit |
| 1 | ord. no. ACS 007 | spray cans holder kit |
| 1 | ord. no. ACS 005 | paper roll holder with paper roll |
| 1 | ord. no. ACS 003 | support with belt for gas cylinders and extinguishers (extinguisher not supplied) |



EXPERT



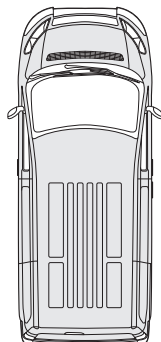
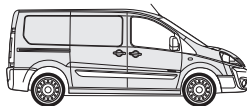
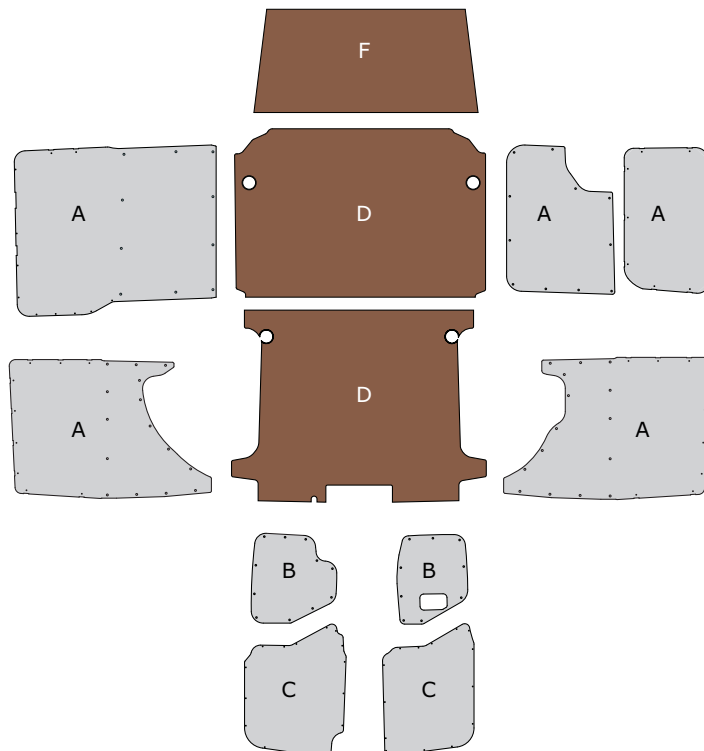

FLOORINGS AND LININGS
for EXPERT with RH side sliding door and rear leaf doors, sheet metal side walls

A + B Polypropylene linings
Order no. PAN 003

 Weight: **8,23 Kg**
Polypropylene linings for:

- LH side wall
- RH side wall and sliding door
- lower section of rear leaf doors

 Technical
 features,
 see page 5

C Polypropylene linings
Order no. PAR 002

 Weight: **1,51 Kg**
Polypropylene linings for:

- upper section of rear leaf doors

D Flooring
Order no. PIL 003

 Weight: **25,88 Kg**
12 mm thick wooden flooring phenolic coated and predrilling for lashing hook supports.

F Bulkhead
Order no. PIR 002

 Weight: **7,15 Kg**
12 mm wooden phenolic coated bulkhead panel.
ROOF RACK only for EXPERT with rear leaf doors

Order no. POT 003

 Dimensions: **2500x1600 mm** (WxD)

 Weight: **23,00 Kg**
Roof rack complete with:

- 3 aluminium crossmembers with fixing connectors and rubber profile
- 2 2500 mm long aluminium side upstands
- 1 aluminium loading roller

 Supplied with **stainless steel** screws for fixing.

Load capacity: 79 Kg (p.u.d.)

 Technical
 features,
 see page 7

LADDER RACK only for EXPERT with rear leaf doors

The ladder rack rail can be mounted on the right or on the left hand side of the vehicle

Order no. POS 003

 Dimensions: **2650x1580 mm** (WxD)

 Weight: **52,40 Kg**
Ladder rack complete with:

- 4 aluminium crossmembers with fixing connectors and rubber profile
- 1 2500 mm long aluminium side upstand
- 1 aluminium loading roller
- 1 ladder rack rail made from stainless steel and aluminium **TALENTO** series, length 2650 mm

 Supplied with **stainless steel** screws for fixing.

Load capacity: 84 Kg (p.u.d.)

5 m³
L1 H1 wheelbase 3000 mm



EXPERT L1 H1 panel van
Short low van

READY SOLUTIONS



Order no. MDL S01

Dimensions: **1733x365x1200 mm** (WxDxH). Weight: **43,25 Kg**

Module complete with:

- 3 trays with rubber and 15 adjustable dividers
- 1 fixing bar length 2500 mm



Order no. MDL 008

Dimensions: **1016x365x900 mm** (WxDxH). Weight: **41,7 Kg**

Module complete with:

- 1 tray with rubber and 3 adjustable dividers
- 2 drawers
- 1 shelf with door
- 1 hinged door



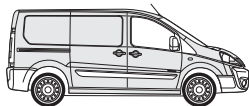

MODULES 717 MM

Technical features, see page 5
Accessories see page 9



Suitable to be installed in the zone: **2 5**

Order no. MDL 005

Dimensions: **717x365x900 mm** (WxDxH)

Weight: **32,9 Kg**

Module complete with:

- 1 tray with rubber and 2 adjustable dividers
- 2 drawers
- 1 shelf with door



Suitable to be installed in the zone: **2 5**

Order no. MDL 006

Dimensions: **717x365x900 mm** (WxDxH)

Weight: **22,7 Kg**

Module complete with:

- 3 trays with rubber and 6 adjustable dividers

*approximate measurement

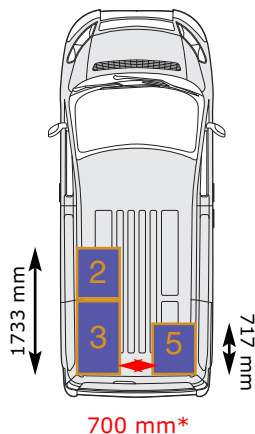

Suitable to be installed in the zone: **5**

Order no. MDL 007

Dimensions: **717x365x900 mm** (WxDxH)

Weight: **42,7 Kg**

Module complete with:

- 3 trays with rubber and 6 adjustable dividers
- 1 retractable vice workbench complete with steel vice with 100 mm jaws and 1/2" to 1 1/2" pipe clamp



Suitable to be installed in the zone: **2**

Order no. MDL 011

Dimensions: **717x365x900 mm** (WxDxH)

Weight: **20 Kg**

Module complete with:

- 1 tray with rubber and 2 adjustable dividers
- 1 shelf with door
- 1 connection bar with fixing belts for tool cases

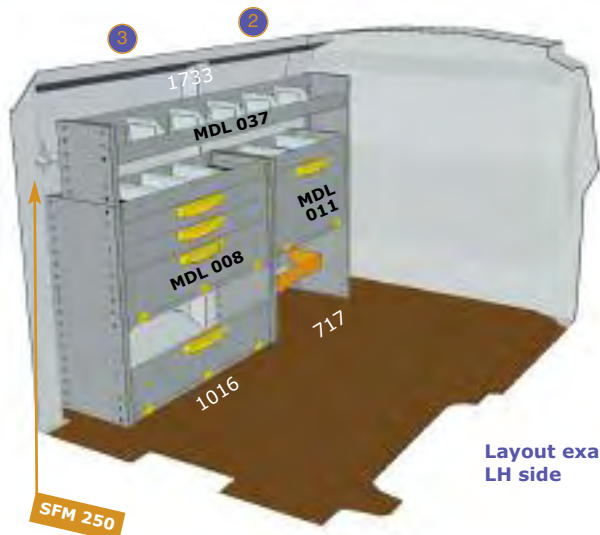

Layout example of LH side



Layout example of RH side

5 m³
L1 H1 wheelbase 3000 mm



EXPERT L1 H1 panel van
Short low van

MODULES 1016 MM



Suitable to be installed in the zone: **3**

Order no. MDL 008

Dimensions: **1016x365x900 mm** (WxDxH)

Weight: **41,7 Kg**

Module complete with:

- 1 tray with rubber and 3 adjustable dividers
- 2 drawers
- 1 shelf with door
- 1 hinged door



Suitable to be installed in the zone: **3**

Order no. MDL 009

Dimensions: **1016x365x900 mm** (WxDxH)

Weight: **25,4 Kg**

Module complete with:

- 3 trays with rubber and 9 adjustable dividers



Suitable to be installed in the zone: **3**

Order no. MDL 010

Dimensions: **1016x365x900 mm** (WxDxH)

Weight: **60,1 Kg**

Module complete with:

- 1 tray with rubber and 3 adjustable dividers
- 3 drawers
- 3 retractable shelves for tool cases complete with tool cases and boxes

ADD-ON MODULE 1733 MM



Suitable to be installed in the zone: **2 + 3**

Order no. MDL 037

Dimensions: **1733x265x300 mm** (WxDxH)

Weight: **10,80 Kg**

Module complete with:

- 1 tray with rubber and 5 adjustable dividers

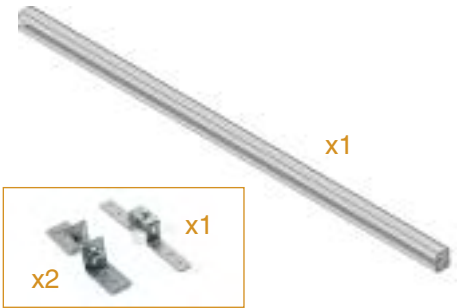

Order no. SFM 250

Fixing bar: **2500x30x35 mm** (WxDxH)

Weight: **2,2 Kg**

Fixing bar for upper modules, complete with brackets, bolts and screws.

The bar is necessary to fix the additional MDL 037 module to the vehicle.

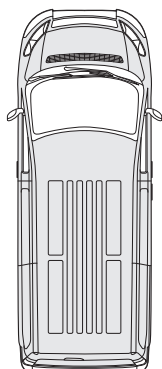
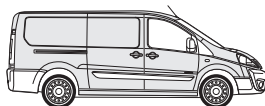

FLOORINGS AND LININGS

for EXPERT with RH side sliding door and rear leaf doors, sheet metal side walls

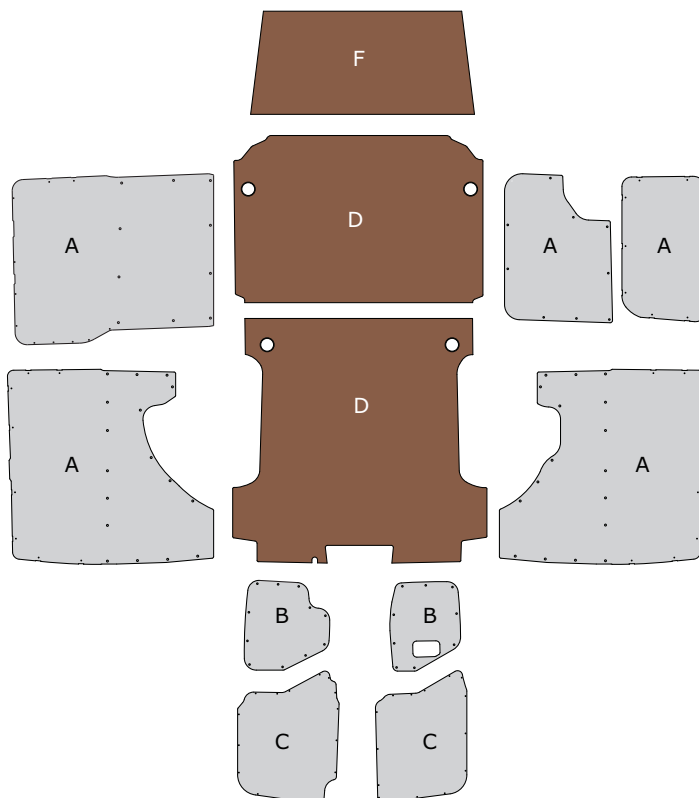
A + B Polypropylene linings
Order no. PAN 004

 Weight: **9,71 Kg**
Polypropylene linings for:

- LH side wall
- RH side wall and sliding door
- lower section of rear leaf doors

 Technical features,
 see page 5

C Polypropylene linings
Order no. PAR 002

 Weight: **1,51 Kg**
Polypropylene linings for:

- upper section of rear leaf doors

D Flooring
Order no. PIL 004

 Weight: **30,00 Kg**
12 mm thick wooden flooring phenolic coated and predrilling for lashing hook supports.

F Bulkhead
Order no. PIR 002

 Weight: **7,15 Kg**
12 mm wooden phenolic coated bulkhead panel.
ROOF RACK only for EXPERT with rear leaf doors

Order no. POT 004

 Dimensions: **2500x1600 mm (WxD)**

 Weight: **27 Kg**
Roof rack complete with:

- 4 aluminium crossmembers with fixing connectors and rubber profile
- 2 2500 mm long aluminium side upstands
- 1 aluminium loading roller

 Supplied with **stainless steel** screws for fixing.

Load capacity: 86 Kg (p.u.d.)

 Technical features,
 see page 7

LADDER RACK only for EXPERT with rear leaf doors

The ladder rack rail can be mounted on the right or on the left hand side of the vehicle

Order no. POS 004

 Dimensions: **2650x1580 mm (WxD)**

 Weight: **56,3 Kg**
Ladder rack complete with:

- 5 aluminium crossmembers with fixing connectors and rubber profile
- 1 2500 mm long aluminium side upstand
- 1 aluminium loading roller
- 1 ladder rack rail made from stainless steel and aluminium **TALENTO** series, length 2650 mm

 Supplied with **stainless steel** screws for fixing.

Load capacity: 85 Kg (p.u.d.)

6 m³
L2 H1 wheelbase 3122 mm

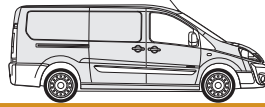

EXPERT L2 H1 panel van
Long low van

READY SOLUTIONS



Order no. MDL S02

Dimensions: **2032x365x1200 mm** (WxDxH). Weight: **46,35 Kg**

Module complete with:

- 3 trays with rubber and 15 adjustable dividers
- 1 fixing bar length 3000 mm



Order no. MDL 010

Dimensions: **1016x365x900 mm** (WxDxH). Weight: **60,1 Kg**

Module complete with:

- 1 tray with rubber and 3 adjustable dividers
- 3 drawers
- 3 retractable shelves for tool cases complete with tool cases and boxes



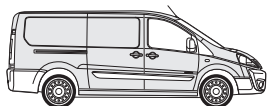

MODULES 1016 MM



Suitable to be installed in the zone: **2 3 5**

Order no. MDL 002

Dimensions: **1016x365x900 mm** (WxDxH)

Weight: **43,80 Kg**

Module complete with:

- 1 tray with rubber and 3 adjustable dividers
- 2 drawers
- 1 shelf with door
- 1 hinged door



Suitable to be installed in the zone: **2 3 5**

Order no. MDL 004

Dimensions: **1016x365x900 mm** (WxDxH)

Weight: **28,80 Kg**

Module complete with:

- 3 trays with rubber and 9 adjustable dividers



Suitable to be installed in the zone: **2 3 5**

Order no. MDL 001

Dimensions: **1016x365x900 mm** (WxDxH)

Weight: **61,00 Kg**

Module complete with:

- 1 tray with rubber and 3 adjustable dividers
- 3 drawers
- 3 retractable shelves for tool cases complete with tool cases and boxes



Suitable to be installed in the zone: **2**

Order no. MDL 012

Dimensions: **1016x365x900 mm** (WxDxH)

Weight: **25,2 Kg**

Module complete with:

- 1 tray with rubber and 3 adjustable dividers
- 1 shelf with door
- 1 connection bar with fixing belts for tool cases



Suitable to be installed in the zone: **5**

Order no. MDL 013

Dimensions: **1016x365x900 mm** (WxDxH)

Weight: **49,7 Kg**

Module complete with:

- 3 trays with rubber and 9 adjustable dividers
- 1 retractable vice workbench complete with steel vice with 100 mm jaws and 1/2" to 1 1/2" pipe clamp

Technical features, see page 5
Accessories see page 9

*approximate measurement

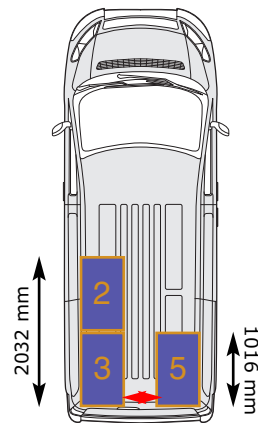

700 mm*

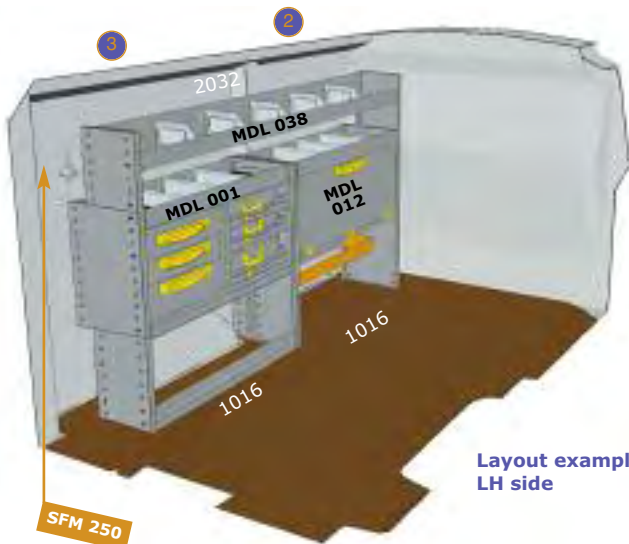

Layout example of LH side

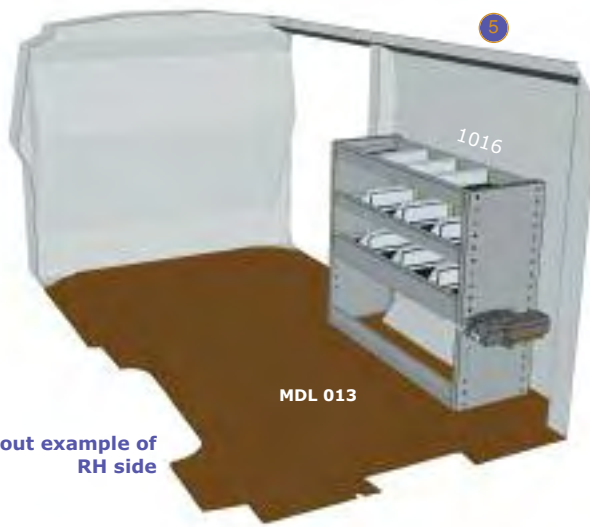

Layout example of RH side

SFM 250

6 m³
L2 H1 wheelbase 3122 mm

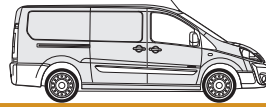

EXPERT L2 H1 panel van
Long low van

ADD-ON MODULE 2032 MM



Suitable to be installed in the zone: **2** + **3**

Order no. MDL 038

Dimensions: **2032x265x300 mm** (WxDxH)

Weight: **11,20 Kg**

Module complete with:

1 tray with rubber and 5 adjustable dividers



Order no. SFM 250

Fixing bar: **2500x30x35 mm** (WxDxH)

Weight: **2,2 Kg**

Fixing bar for upper modules, complete with brackets, bolts and screws.

The bar is necessary to fix the additional MDL 038 module to the vehicle.



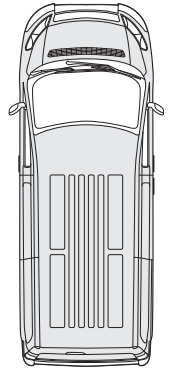

FLOORINGS AND LININGS

for EXPERT with RH side sliding door and rear leaf doors, sheet metal side walls

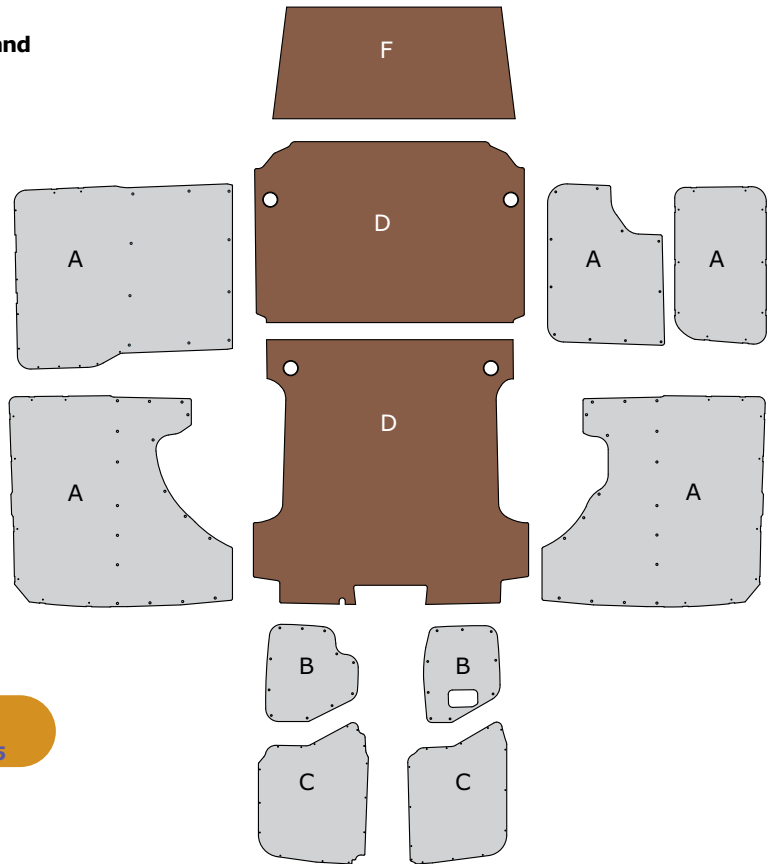

A + **B** Polypropylene linings Order no. PAN 005

Weight: **9,68 Kg**

Polypropylene linings for:

- LH side wall
- RH side wall and sliding door
- lower section of rear leaf doors

Technical
features,
see page 5

C Polypropylene linings Order no. PAR 008

Weight: **1,51 Kg**

Polypropylene linings for:

- upper section of rear leaf doors

D Flooring Order no. PIL 004

Weight: **30,00 Kg**

12 mm thick wooden flooring phenolic coated and predrilling for lashing hook supports.

F Bulkhead Order no. PIR 002

Weight: **7,15 Kg**

12 mm wooden phenolic coated bulkhead panel.

READY SOLUTIONS



Order no. MDL S02

Dimensions: **2032x365x1200 mm** (WxDxH). Weight: **46,35 Kg**

Module complete with:

- 3 trays with rubber and 15 adjustable dividers
- 1 fixing bar length 3000 mm



Order no. MDL 010

Dimensions: **1016x365x900 mm** (WxDxH). Weight: **60,1 Kg**

Module complete with:

- 1 tray with rubber and 3 adjustable dividers
- 3 drawers
- 3 retractable shelves for tool cases complete with tool cases and boxes



MODULES 1016 MM



Suitable to be installed in the zone: **2 3 5**

Order no. MDL 002

Dimensions: **1016x365x900 mm** (WxDxH)

Weight: **43,80 Kg**

Module complete with:

- 1 tray with rubber and 3 adjustable dividers
- 2 drawers
- 1 shelf with door
- 1 hinged door



Suitable to be installed in the zone: **2 3 5**

Order no. MDL 004

Dimensions: **1016x365x900 mm** (WxDxH)

Weight: **28,80 Kg**

Module complete with:

- 3 trays with rubber and 9 adjustable dividers



Suitable to be installed in the zone: **2 3 5**

Order no. MDL 001

Dimensions: **1016x365x900 mm** (WxDxH)

Weight: **61,00 Kg**

Module complete with:

- 1 tray with rubber and 3 adjustable dividers
- 3 drawers
- 3 retractable shelves for tool cases complete with tool cases and boxes



Suitable to be installed in the zone: **2**

Order no. MDL 012

Dimensions: **1016x365x900 mm** (WxDxH)

Weight: **25,2 Kg**

Module complete with:

- 1 tray with rubber and 3 adjustable dividers
- 1 shelf with door
- 1 connection bar with fixing belts for tool cases

ADD-ON MODULE 2032 MM



Suitable to be installed in the zone: **2 + 3**

Order no. MDL 038

Dimensions: **2032x265x300 mm** (WxDxH)

Weight: **11,20 Kg**

Module complete with:

- 1 tray with rubber and 5 adjustable dividers



Order no. SFM 250

Fixing bar: **2500x30x35 mm** (WxDxH)

Weight: **2,2 Kg**

Fixing bar for upper modules, complete with brackets, bolts and screws.

The bar is necessary to fix the additional MDL 038 module to the vehicle.

Technical features, see page 5

Accessories see page 9



Suitable to be installed in the zone: **5**

Order no. MDL 013

Dimensions: **1016x365x900 mm** (WxDxH)

Weight: **49,7 Kg**

Module complete with:

- 3 trays with rubber and 9 adjustable dividers
- 1 retractable vice workbench complete with steel vice with 100 mm jaws and 1/2" to 1 1/2" pipe clamp

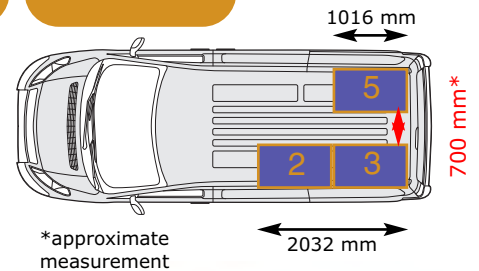

*approximate measurement

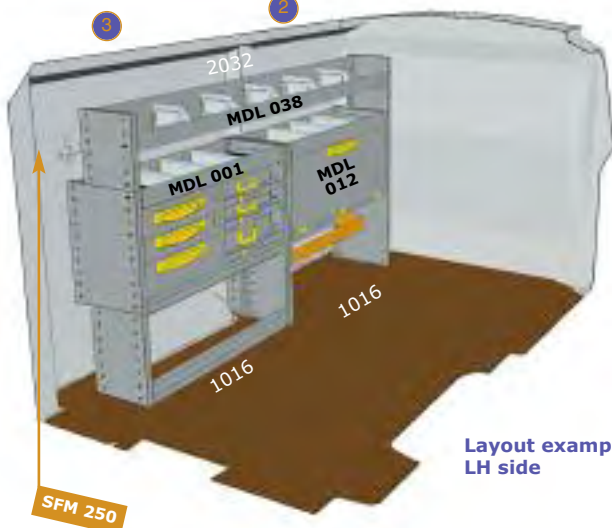

Layout example of LH side



Layout example of RH side

Strategically strong



Boxer L3 H2 - 13 m³

Vehicle equipped with:

- > **FAST ASSEMBLY**
- > **TOTAL MODULARITY**
- > **SAFETY SOUND ABSORBING ELEMENTS BETWEEN THE VARIOUS METAL COMPONENTS**
- > **ERGONOMIC SHAPES**
- > **HEIGHT ADJUSTMENT IN PITCH OF 25 mm OF THE VARIOUS ELEMENTS**

- 1 ord. no. POS 008 ladder rack (ladder not supplied)
- 1 ord. no. PIL 007 wooden flooring
- 1 ord. no. PAN 009 polypropylene linings
- 1 ord. no. PIR 003 wooden phenolic coated bulkhead panel
- 1 ord. no. MDL 014 module
- 1 ord. no. MDL 015 module
- 1 ord. no. MDL 017 module
- 1 ord. no. MDL 018 module
- 1 ord. no. ACS 003 support with belt for gas cylinders and extinguishers (extinguisher not supplied)
- 1 ord. no. ACS 004 first aid kit
- 1 ord. no. ACS 007 spray cans holder kit
- 1 ord. no. ACS 009 load retaining bar and belts



BOXER







FLOORINGS AND LININGS

for BOXER with RH side sliding door and rear leaf doors, sheet metal side walls

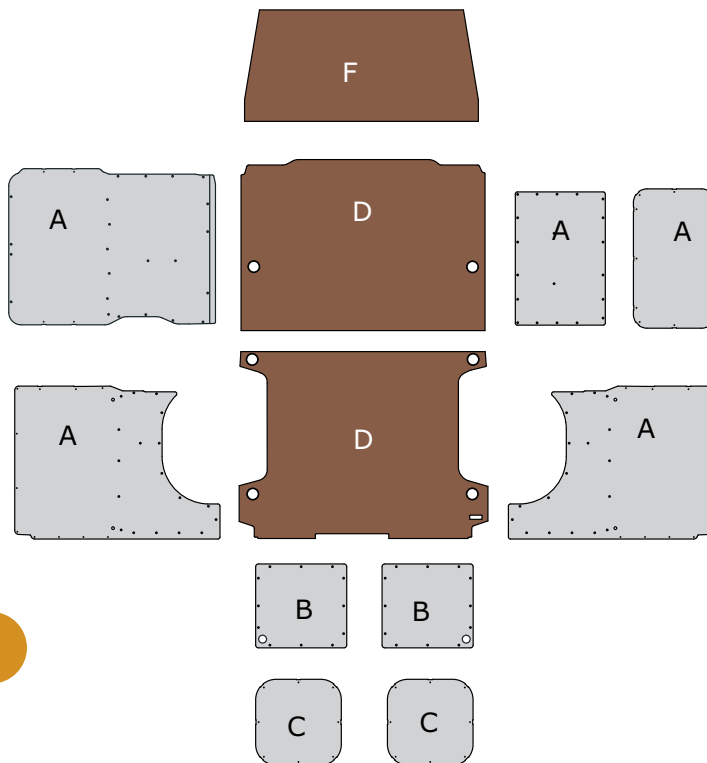
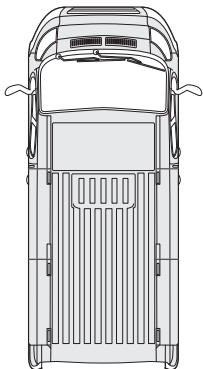

A + B Polypropylene linings Order no. PAN 006

Weight: **11,82 Kg**

Polypropylene linings for:

- LH side wall
- RH side wall and sliding door
- lower section of rear leaf doors

Technical
features,
see page 5

C Polypropylene linings Order no. PAR 003

Weight: **1,41 Kg**

Polypropylene linings for:

- upper section of rear leaf doors

D Flooring Order no. PIL 005

Weight: **36,71 Kg**

12 mm thick wooden flooring phenolic coated and predrilling for lashing hook supports.

F Bulkhead Order no. PIR 003

Weight: **11,24 Kg**

12 mm wooden phenolic coated bulkhead panel.

ROOF RACK



Order no. POT 005

Dimensions: **3000x1800 mm** (WxD)

Weight: **28,20 Kg**

Roof rack complete with:

- 3 aluminium crossmembers with fixing connectors and rubber profile
- 2 3000 mm long aluminium side upstands
- 1 aluminium loading roller

Supplied with **stainless steel** screws for fixing.

Load capacity: 124 Kg (p.u.d.)

Technical
features,
see page 7

LADDER RACK

The ladder rack rail can be mounted on the right or on the left hand side of the vehicle



Order no. POS 005

Dimensions: **3000x1780 mm** (WxD)

Weight: **55,20 Kg**

Ladder rack complete with:

- 3 aluminium crossmembers with fixing connectors and rubber profile
- 1 3000 mm long aluminium side upstand
- 1 aluminium loading roller
- 1 ladder rack rail made from stainless steel and aluminium **ALADIN** series, length 2650 mm

Supplied with **stainless steel** screws for fixing.

Load capacity: 96 Kg (p.u.d.)

8 m³
L1 H1 wheelbase 3000 mm



LOADING RAMP

Order no. RAM 001

Dimensions: **1250x2500 mm** (WxD)
Weight: **116,55 Kg**

Swivel loading ramp.

Load capacity: **1000 Kg**
(p.u.d.)



Technical
features,
see page 8

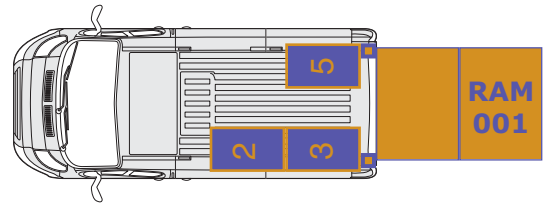

The swivel loading ramp can be installed also when the modules are fitted.

If the loading ramp is fitted, the MDL modules for the areas **3** and **5** must not be longer than 1016 mm.

If the loading ramp is installed the article **MDL 018 cannot be installed** in area **5**.

It is advisable to ask your nearest STORE VAN distributor for a project feasibility study.

READY SOLUTIONS



Order no. MDL 030

Dimensions: **2032x365x1200 mm** (WxDxH). Weight: **45,15 Kg**

Module complete with:

3 trays with rubber and 15 adjustable dividers



Order no. MDL 015

Dimensions: **1016x365x1200 mm** (WxDxH). Weight: **48,3 Kg**

Module complete with:

3 trays with rubber and 9 adjustable dividers

1 drawer

1 retractable shelf for tool cases complete with tool cases and boxes



MODULES 1016 mm



Suitable to be installed in the zone: **2 3 5**

Order no. MDL 014

Dimensions: **1016x365x1200 mm** (WxDxH)

Weight: **49,4 Kg**

Module complete with:

- 2 trays with rubber and 6 adjustable dividers
- 2 drawers
- 1 shelf with door
- 1 hinged door

Suitable to be installed in the zone: **2 3 5**

Order no. MDL 015

Dimensions: **1016x365x1200 mm** (WxDxH)

Weight: **48,3 Kg**

Module complete with:

- 3 trays with rubber and 9 adjustable dividers
- 1 drawer
- 1 retractable shelf for tool cases complete with tool cases and boxes

Suitable to be installed in the zone: **2 3 5**

Order no. MDL 016

Dimensions: **1016x365x1200 mm** (WxDxH)

Weight: **33,2 Kg**

Module complete with:

- 4 trays with rubber and 12 adjustable dividers

Technical features, see page 5
Accessories see page 9

*approximate measurement

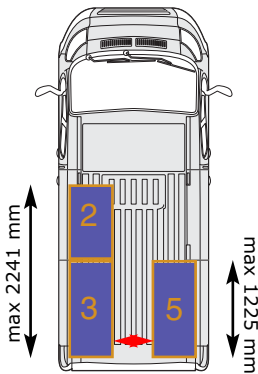

Suitable to be installed in the zone: **2**

Order no. MDL 017

Dimensions: **1016x365x1200 mm** (WxDxH)

Weight: **33 Kg**

Module complete with:

- 2 trays with rubber and 6 adjustable dividers
- 1 shelf with door
- 1 connection bar with fixing belts for tool cases

Suitable to be installed in the zone: **5**

Order no. MDL 018

Dimensions: **1016x365x1200 mm** (WxDxH)

Weight: **57,5 Kg**

Module complete with:

- 4 trays with rubber and 12 adjustable dividers
- 1 retractable vice workbench complete with steel vice with 100 mm jaws and 1/2" to 1 1/2" pipe clamp

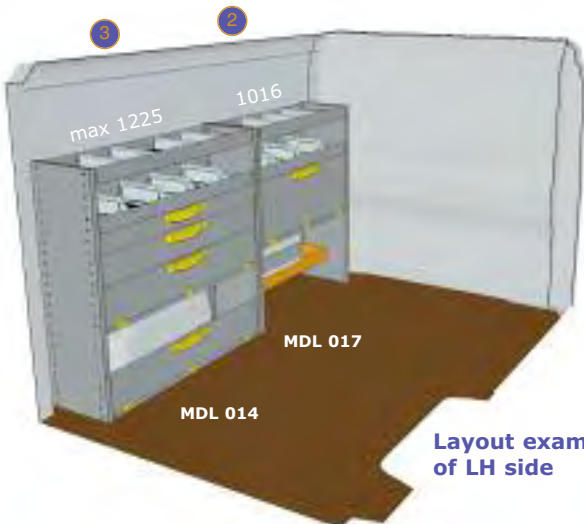

Layout example of LH side



Layout example of RH side

8 m³
L1 H1 wheelbase 3000 mm



MODULES 1225 mm



Suitable to be installed in the zone: **3 5**

Order no. MDL 020

Dimensions: **1225x365x1200 mm** (WxDxH)

Weight: **57,35 Kg**

Module complete with:

- 2 trays with rubber and 8 adjustable dividers
- 2 drawers
- 1 shelf with door
- 1 hinged door



Suitable to be installed in the zone: **3 5**

Order no. MDL 021

Dimensions: **1225x365x1200 mm** (WxDxH)

Weight: **55,35 Kg**

Module complete with:

- 3 trays with rubber and 12 adjustable dividers
- 1 drawer
- 1 retractable shelf for tool cases complete with tool cases and boxes



Suitable to be installed in the zone: **3 5**

Order no. MDL 022

Dimensions: **1225x365x1200 mm** (WxDxH)

Weight: **39,40 Kg**

Module complete with:

- 4 trays with rubber and 16 adjustable dividers



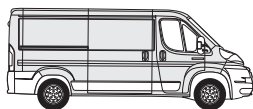

FLOORINGS AND LININGS

for BOXER with RH and LH sliding doors, rear leaf doors, sheet metal side walls

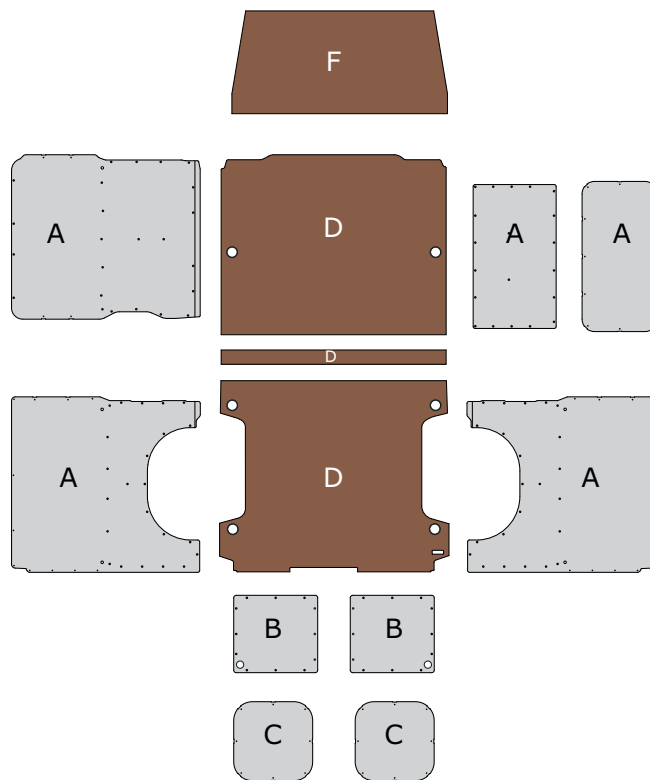
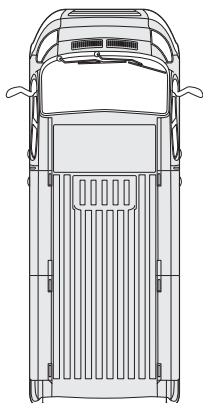

A + B Polypropylene linings Order no. PAN 007

Weight: **14,27 Kg**

Polypropylene linings for:

- LH side wall
- RH side wall and sliding door
- lower section of rear leaf doors

Technical
features,
see page 5

C Polypropylene linings Order no. PAR 003

Weight: **1,41 Kg**

Polypropylene linings for:

- upper section of rear leaf doors

D Flooring Order no. PIL 006

Weight: **43,26 Kg**

12 mm thick wooden flooring phenolic coated and predrilling for lashing hook supports.

F Bulkhead Order no. PIR 003

Weight: **11,24 Kg**

12 mm wooden phenolic coated bulkhead panel.

ROOF RACK



Order no. POT 006

Dimensions: **3400x1800 mm** (WxD)

Weight: **29,80 Kg**

Roof rack complete with:

- 3 aluminium crossmembers with fixing connectors and rubber profile
- 2 3400 mm long aluminium side upstands
- 1 aluminium loading roller

Supplied with **stainless steel** screws for fixing.

Load capacity: 123 Kg (p.u.d.)

Technical
features,
see page 7

LADDER RACK

The ladder rack slide can be mounted on the right or on the left hand side of the vehicle



Order no. POS 006

Dimensions: **3400x1780 mm** (WxD)

Weight: **60,15 Kg**

Ladder rack complete with:

- 3 aluminium crossmembers with fixing connectors and rubber profile
- 1 3400 mm long aluminium side upstand
- 1 aluminium loading roller
- 1 ladder rack rail made from stainless steel and aluminium **ALADIN** series, length 3240 mm

Supplied with **stainless steel** screws for fixing.

Load capacity: 91 Kg (p.u.d.)

10 m³
L2 H1 wheelbase 3450 mm

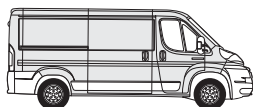

60

BOXER L2 H1
panel van

LOADING RAMP

Order no. RAM 001

Dimensions: **1250x2500 mm** (WxD)

Weight: **116,55 Kg**

Swivel loading ramp.

Load capacity: **1000 Kg**
(p.u.d.)



Technical
features,
see page 8

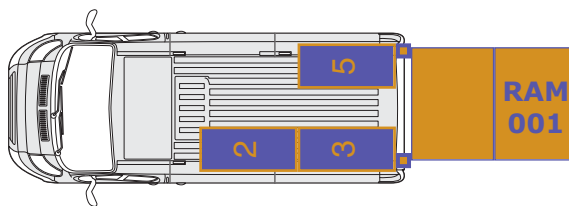

The swivel loading ramp can be installed also when the modules are fitted.

If the loading ramp is fitted, the MDL modules for the areas **3** and **5** must not be longer than 1225 mm.

If the loading ramp is installed the article **MDL 024 cannot be installed** in area **5**.

It is advisable to ask your nearest STORE VAN distributor for a project feasibility study.

READY SOLUTIONS



MDL S22

Order no. MDL S22

Dimensions: **2450x365x1200 mm** (WxDxH). Weight: **69,00 Kg**

Set of 2 modules complete with:

- 5 trays with rubber and 19 adjustable dividers
- 1 shelf with door
- 1 connection bar with fixing belts for tool cases



MDL 020

Order no. MDL 020

Dimensions: **1225x365x1200 mm** (WxDxH). Weight: **57,35 Kg**

Module complete with:

- 2 trays with rubber and 8 adjustable dividers
- 2 drawers
- 1 shelf with door
- 1 hinged door

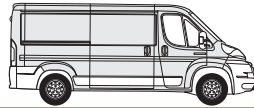

MODULES 1016 mm



Suitable to be installed in the zone: **2 3 5**

Order no. MDL 014

Dimensions: **1016x365x1200 mm** (WxDxH)

Weight: **49,4 Kg**

Module complete with:

- 2 trays with rubber and 6 adjustable dividers
- 2 drawers
- 1 shelf with door
- 1 hinged door

Suitable to be installed in the zone: **2 3 5**

Order no. MDL 015

Dimensions: **1016x365x1200 mm** (WxDxH)

Weight: **48,3 Kg**

Module complete with:

- 3 trays with rubber and 9 adjustable dividers
- 1 drawer
- 1 retractable shelf for tool cases complete with tool cases and boxes

Suitable to be installed in the zone: **2 3 5**

Order no. MDL 016

Dimensions: **1016x365x1200 mm** (WxDxH)

Weight: **33,2 Kg**

Module complete with:

- 4 trays with rubber and 12 adjustable dividers

*approximate measurement

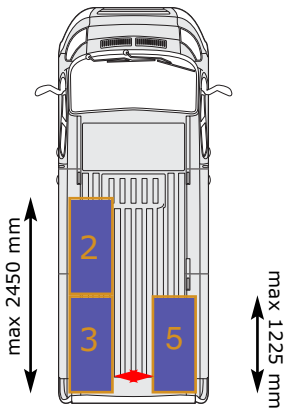

Technical features, see page 5

Accessories see page 9



Suitable to be installed in the zone: **2**

Order no. MDL 017

Dimensions: **1016x365x1200 mm** (WxDxH)

Weight: **33 Kg**

Module complete with:

- 2 trays with rubber and 6 adjustable dividers
- 1 shelf with door
- 1 connection bar with fixing belts for tool cases

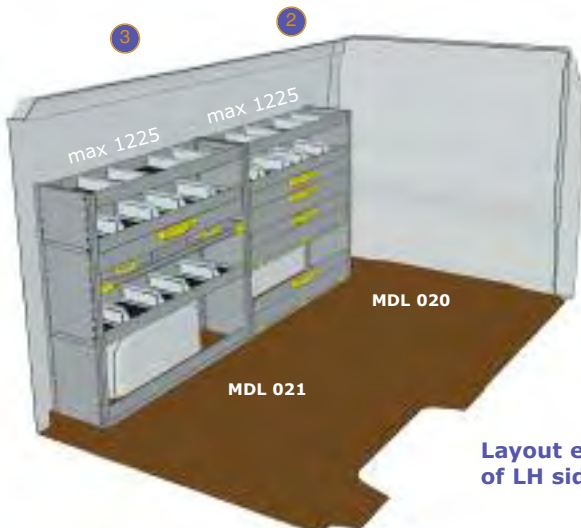

Layout example of LH side

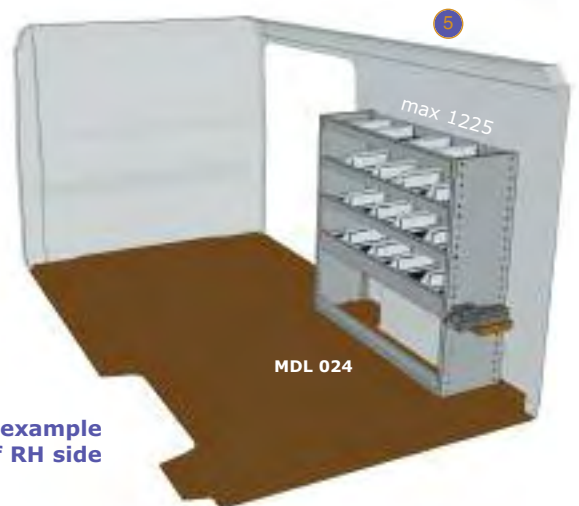

Layout example of RH side

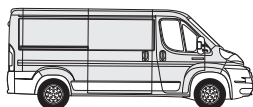

MODULES 1225 mm



Suitable to be installed in the zone: **2 3 5**

Order no. MDL 020

Dimensions: **1225x365x1200 mm** (WxDxH)

Weight: **57,35 Kg**

Module complete with:

- 2 trays with rubber and 8 adjustable dividers
- 2 drawers
- 1 shelf with door
- 1 hinged door



Suitable to be installed in the zone: **2 3 5**

Order no. MDL 021

Dimensions: **1225x365x1200 mm** (WxDxH)

Weight: **55,35 Kg**

Module complete with:

- 3 trays with rubber and 12 adjustable dividers
- 1 drawer
- 1 retractable shelf for tool cases complete with tool cases and boxes



Suitable to be installed in the zone: **2 3 5**

Order no. MDL 022

Dimensions: **1225x365x1200 mm** (WxDxH)

Weight: **39,40 Kg**

Module complete with:

- 4 trays with rubber and 16 adjustable dividers



Suitable to be installed in the zone: **2**

Order no. MDL 023

Dimensions: **1225x365x1200 mm** (WxDxH)

Weight: **39,05 Kg**

Module complete with:

- 2 trays with rubber and 8 adjustable dividers
- 1 shelf with door
- 1 connection bar with fixing belts for tool cases



Suitable to be installed in the zone: **5**

Order no. MDL 024

Dimensions: **1225x365x1200 mm** (WxDxH)

Weight: **66,45 Kg**

Module complete with:

- 4 trays with rubber and 16 adjustable dividers
- 1 retractable vice workbench complete with steel vice with 100 mm jaws and 1/2" to 1 1/2" pipe clamp

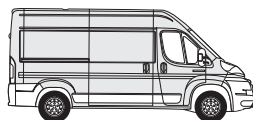

FLOORINGS AND LININGS

for BOXER with RH lateral sliding door and rear leaf doors, sheet metal clad walls

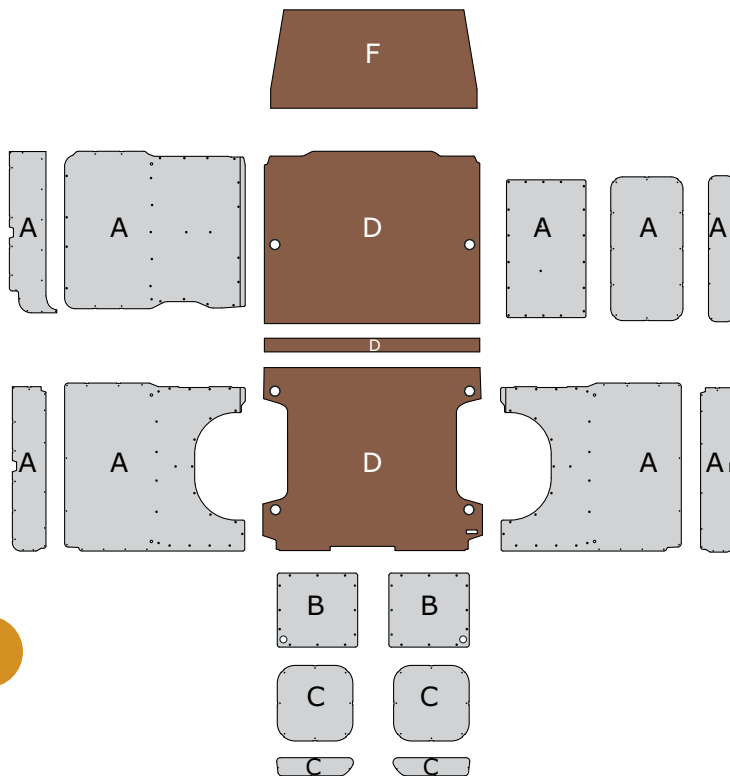
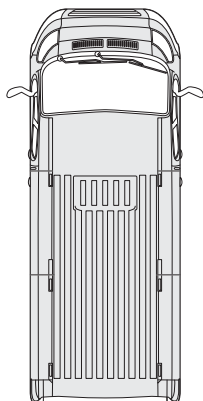

A + B Polypropylene linings Order no. PAN 008

Weight: **16,88 Kg**

Polypropylene linings for:

- LH side wall
- RH side wall and sliding door
- lower section of rear leaf doors

Technical
features,
see page 5

C Polypropylene linings Order no. PAR 004

Weight: **1,75 Kg**

Polypropylene linings for:

- upper section of rear leaf doors

D Flooring Order no. PIL 006

Weight: **43,26 Kg**

12 mm thick wooden flooring phenolic coated and predrilling for lashing hook supports.

F Bulkhead Order no. PIR 003

Weight: **11,24 Kg**

12 mm wooden phenolic coated bulkhead panel.

ROOF RACK



Order no. POT 010

Dimensions: **3400x1700 mm** (WxD)

Weight: **29,00 Kg**

Roof rack complete with:

- 3 aluminium crossmembers with fixing connectors and rubber profile
- 2 3400 mm long aluminium side upstands
- 1 aluminium loading roller

Supplied with **stainless steel** screws for fixing.

Load capacity: 124 Kg (p.u.d.)

Technical
features,
see page 7

LADDER RACK

The ladder rack slide can be mounted on the right or on the left hand side of the vehicle



Order no. POS 007

Dimensions: **3400x1680 mm** (WxD)

Weight: **58,56 Kg**

Ladder rack complete with:

- 3 aluminium crossmembers with fixing connectors and rubber profile
- 1 3400 mm long aluminium side upstand
- 1 aluminium loading roller
- 1 ladder rack rail made from stainless steel and aluminium **ALADIN** series, length 3240 mm

Supplied with **stainless steel** screws for fixing.

Load capacity: 93 Kg (p.u.d.)

11,5 m³
L2 H2 wheelbase 3450 mm

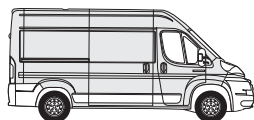

64

BOXER L2 H2
panel van

LOADING RAMP

Order no. RAM 002

Dimensions: **1250x2500 mm** (WxD)

Weight: **116,55 Kg**

Swivel loading ramp.

Load capacity: **1000 Kg**
(p.u.d.)



Technical
features,
see page 8

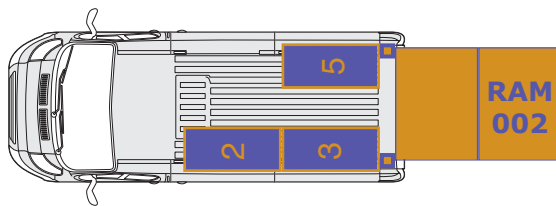

The swivel loading ramp can be installed also when the modules are fitted.

If the loading ramp is fitted, the MDL modules for the areas **3** and **5** must not be longer than 1225 mm.

If the loading ramp is installed the article **MDL 124 cannot be installed** in area **5**.

It is advisable to ask your nearest STORE VAN distributor for a project feasibility study.

READY SOLUTIONS



MDL S23

Order no. MDL S23

Dimensions: **2450x365x1700 mm** (WxDxH). Weight: **94,75 Kg**

Set of 2 modules complete with:

- 8 trays with rubber and 28 adjustable dividers
- 1 shelf with door
- 1 connection bar with fixing belts for tool cases
- 1 fixing bar length 3000 mm



MDL S21

Order no. MDL S21

Dimensions: **1225x365x1700 mm** (WxDxH). Weight: **74,85 Kg**

Module complete with:

- 4 trays with rubber and 16 adjustable dividers
- 2 drawers
- 1 shelf with door
- 1 hinged door
- 1 fixing bar length 2000 mm



MODULES 1016 MM



Suitable to be installed in the zone: **2 3 5**

Order no. MDL 114

Dimensions: **1016x365x1700 mm** (WxDxH)

Weight: **62,90 Kg**

Module complete with:

- 4 trays with rubber and 12 adjustable dividers
- 2 drawers
- 1 shelf with door
- 1 hinged door



Suitable to be installed in the zone: **2 3 5**

Order no. MDL 115

Dimensions: **1016x365x1700 mm** (WxDxH)

Weight: **61,80 Kg**

Module complete with:

- 5 trays with rubber and 15 adjustable dividers
- 1 drawer
- 1 retractable shelf for tool cases complete with tool cases and boxes



Suitable to be installed in the zone: **2 3 5**

Order no. MDL 116

Dimensions: **1016x365x1700 mm** (WxDxH)

Weight: **46,70 Kg**

Module complete with:

- 6 trays with rubber and 18 adjustable dividers

*approximate measurement

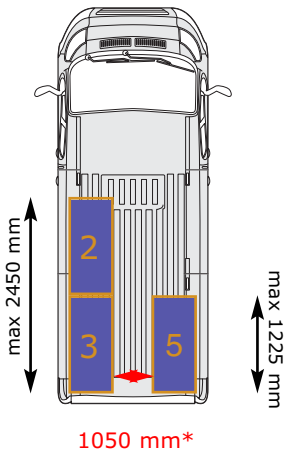

Technical features, see page 5

Accessories see page 9



Suitable to be installed in the zone: **2**

Order no. MDL 117

Dimensions: **1016x365x1700 mm** (WxDxH)

Weight: **46,50 Kg**

Module complete with:

- 4 trays with rubber and 12 adjustable dividers
- 1 shelf with door
- 1 connection bar with fixing belts for tool cases



Layout example of LH side



Layout example of RH side



MODULES 1225 MM



Suitable to be installed in the zone: **2 3 5**

Order no. MDL 120

Dimensions: **1225x365x1700 mm** (WxDxH)

Weight: **72,95 Kg**

Module complete with:

- 4 trays with rubber and 16 adjustable dividers
- 2 drawers
- 1 shelf with door
- 1 hinged door



Suitable to be installed in the zone: **2 3 5**

Order no. MDL 121

Dimensions: **1225x365x1700 mm** (WxDxH)

Weight: **70,95 Kg**

Module complete with:

- 5 trays with rubber and 20 adjustable dividers
- 1 drawer
- 1 retractable shelf for tool cases complete with tool cases and boxes



Suitable to be installed in the zone: **2 3 5**

Order no. MDL 122

Dimensions: **1225x365x1700 mm** (WxDxH)

Weight: **55,00 Kg**

Module complete with:

- 6 trays with rubber and 24 adjustable dividers



Suitable to be installed in the zone: **2**

Order no. MDL 123

Dimensions: **1225x365x1700 mm** (WxDxH)

Weight: **54,65 Kg**

Module complete with:

- 4 trays with rubber and 16 adjustable dividers
- 1 shelf with door
- 1 connection bar with fixing belts for tool cases



Suitable to be installed in the zone: **5**

Order no. MDL 124

Dimensions: **1225x365x1700 mm** (WxDxH)

Weight: **82,05 Kg**

Module complete with:

- 6 trays with rubber and 24 adjustable dividers
- 1 retractable vice workbench complete with steel vice with 100 mm jaws and 1/2" to 1 1/2" pipe clamp



Order no. SFM 300

Fixing bar: **3000x30x35 mm** (WxDxH)

Weight: **2,60 Kg**

Fixing bar for modules, complete with brackets, bolts and screws.

The bar is necessary to fix the modules to the vehicle.



Order no. SFM 200

Fixing bar: **2000x30x35 mm** (WxDxH)

Weight: **1,88 Kg**

Fixing bar for modules, complete with brackets, bolts and screws.

The bar is necessary to fix the modules to the vehicle.

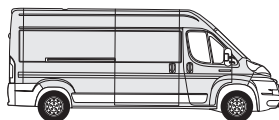

FLOORINGS AND LININGS

for BOXER with RH side sliding door and rear leaf doors, sheet metal side walls

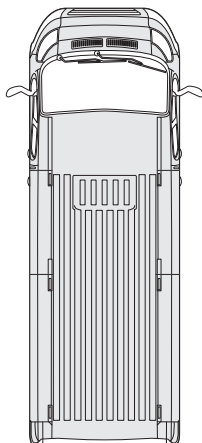

A + B Polypropylene linings Order no. PAN 009

Weight: **21,10 Kg**

Polypropylene linings for:

- LH side wall
- RH side wall and sliding door
- lower section of rear leaf doors

Technical
features,
see page 5

C Polypropylene linings Order no. PAR 004

Weight: **1,75 Kg**

Polypropylene linings for:

- upper section of rear leaf doors

D Flooring Order no. PIL 007

Weight: **52,08 Kg**

12 mm thick wooden flooring phenolic coated and predrilling for lashing hook supports.

F Bulkhead Order no. PIR 003

Weight: **11,24 Kg**

12 mm wooden phenolic coated bulkhead panel.

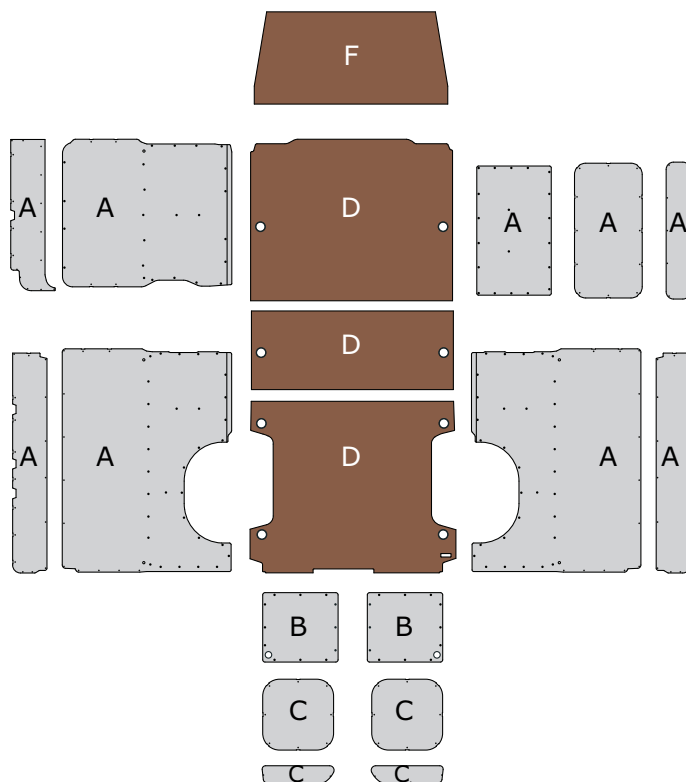

ROOF RACK



Order no. POT 007

Dimensions: **3700x1700 mm (WxD)**

Weight: **34,25 Kg**

Roof rack complete with:

- 4 aluminium crossmembers with fixing connectors and rubber profile
- 2 3700 mm long aluminium side upstands
- 1 aluminium loading roller

Supplied with **stainless steel** screws for fixing.

Load capacity: 114 Kg (p.u.d.)

Technical
features,
see page 7

LADDER RACK

The ladder rack slide can be mounted on the right or on the left hand side of the vehicle



Order no. POS 008

Dimensions: **3700x1680 mm (WxD)**

Weight: **65,90 Kg**

Ladder rack complete with:

- 4 aluminium crossmembers with fixing connectors and rubber profile
- 1 3700 mm long aluminium side upstand
- 1 aluminium loading roller
- 1 ladder rack rail made from stainless steel and aluminium **ALADIN** series, length 3240 mm
- 1 aluminium connection crossmember

Supplied with **stainless steel** screws for fixing.

Load capacity: 83 Kg (p.u.d.)

13 m³
L3 H2 wheelbase 4035 mm

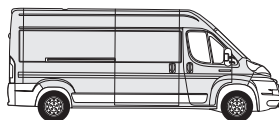

68

BOXER L3 H2
panel van

LOADING RAMP

Order no. RAM 002

Dimensions: **1250x2500 mm** (WxD)

Weight: **116,55 Kg**

Swivel loading ramp.

Load capacity: **1000 Kg**
(p.u.d.)



Technical
features,
see page 8

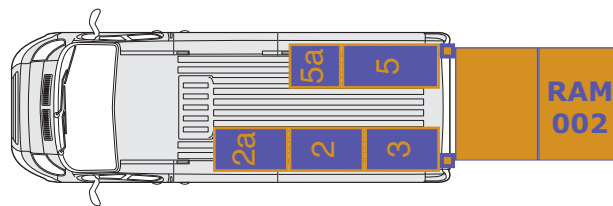

The swivel loading ramp can be installed also when the modules are fitted.

If the loading ramp is fitted, the MDL modules for the area **3** must not be longer than 1016 mm.

If the loading ramp is installed the article **MDL 124 cannot be installed** in area **5**.

It is advisable to ask your nearest STORE VAN distributor for a project feasibility study.

READY SOLUTIONS



Order no. MDL S19

Dimensions: **3257x365x1700 mm** (WxDxH). Weight: **133,95 Kg**

Set of 2 modules complete with:

- 8 trays with rubber and 36 adjustable dividers
- 2 drawers
- 1 shelf with door
- 1 hinged door
- 1 fixing bar length 4000 mm



Order no. MDL S20

Dimensions: **2032x365x1700 mm** (WxDxH). Weight: **60,15 Kg**

Module complete with:

- 4 trays with rubber and 20 adjustable dividers
- 1 fixing bar length 3000 mm

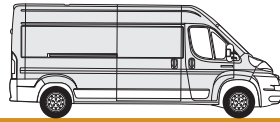

MODULES 717 mm



Suitable to be installed in the zone: **5a**

Order no. MDL 119

Dimensions: **717x365x1700 mm** (WxDxH)

Weight: **38,10 Kg**

Module complete with:

- 4 trays with rubber and 8 adjustable dividers
- 1 shelf with door
- 1 connection bar with fixing belts for tool cases

MODULES 1016 MM



Suitable to be installed in the zone: **2 2a 3 5**

Order no. MDL 114

Dimensions: **1016x365x1700 mm** (WxDxH)

Weight: **62,90 Kg**

Module complete with:

- 4 trays with rubber and 12 adjustable dividers
- 2 drawers
- 1 shelf with door
- 1 hinged door



Suitable to be installed in the zone: **2 2a 3 5**

Order no. MDL 115

Dimensions: **1016x365x1700 mm** (WxDxH)

Weight: **61,80 Kg**

Module complete with:

- 5 trays with rubber and 15 adjustable dividers
- 1 drawer
- 1 retractable shelf for tool cases complete with tool cases and boxes

*approximate measurement

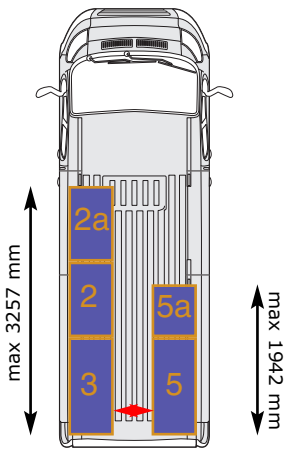

1050 mm*

Suitable to be installed in the zone: **2 2a 3 5**

Order no. MDL 116

Dimensions: **1016x365x1700 mm** (WxDxH)

Weight: **46,70 Kg**

Module complete with:

- 6 trays with rubber and 18 adjustable dividers



Suitable to be installed in the zone: **2 2a**

Order no. MDL 117

Dimensions: **1016x365x1700 mm** (WxDxH)

Weight: **46,50 Kg**

Module complete with:

- 4 trays with rubber and 12 adjustable dividers
- 1 shelf with door
- 1 connection bar with fixing belts for tool cases

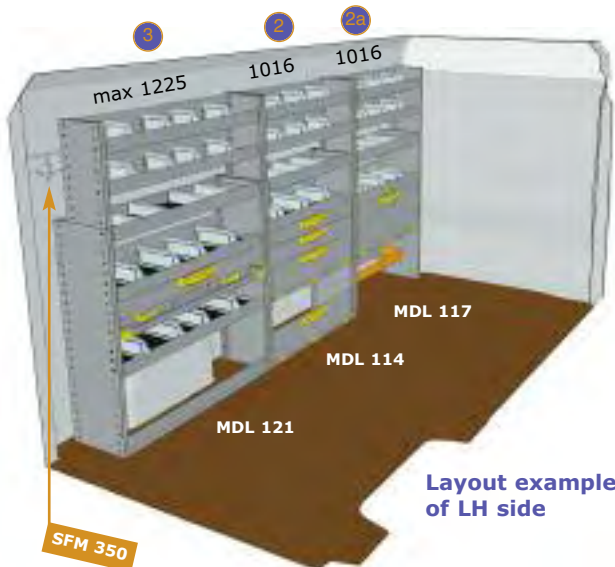

Layout example of LH side



Layout example of RH side

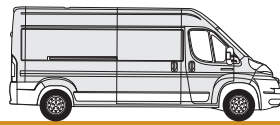

MODULES 1225 MM



Suitable to be installed in the zone: **3 5**

Order no. MDL 120

Dimensions: **1225x365x1700 mm** (WxDxH)

Weight: **72,95 Kg**

Module complete with:

- 4 trays with rubber and 16 adjustable dividers
- 2 drawers
- 1 shelf with door
- 1 hinged door

Suitable to be installed in the zone: **3 5**

Order no. MDL 121

Dimensions: **1225x365x1700 mm** (WxDxH)

Weight: **70,95 Kg**

Module complete with:

- 5 trays with rubber and 20 adjustable dividers
- 1 drawer
- 1 retractable shelf for tool cases complete with tool cases and boxes



Suitable to be installed in the zone: **3 5**

Order no. MDL 122

Dimensions: **1225x365x1700 mm** (WxDxH)

Weight: **55,00 Kg**

Module complete with:

- 6 trays with rubber and 24 adjustable dividers

Suitable to be installed in the zone: **5**

Order no. MDL 124

Dimensions: **1225x365x1700 mm** (WxDxH)

Weight: **82,05 Kg**

Module complete with:

- 6 trays with rubber and 24 adjustable dividers
- 1 retractable vice workbench complete with steel vice with 100 mm jaws and 1/2" to 1 1/2" pipe clamp

Technical features, see page 5

Accessories see page 9



x1



x2

x1

Order no. SFM 350

Fixing bar: **3500x30x35 mm** (WxDxH)

Weight: **2,93 Kg**

Fixing bar for modules, complete with brackets, bolts and screws.

The bar is necessary to fix the modules to the vehicle.



x1



x2

x1

Order no. SFM 250

Fixing bar: **2500x30x35 mm** (WxDxH)

Weight: **2,2 Kg**

Fixing bar for modules, complete with brackets, bolts and screws.

The bar is necessary to fix the modules to the vehicle.



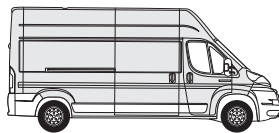

FLOORINGS AND LININGS

for BOXER with RH side sliding door and rear leaf doors, sheet metal side walls

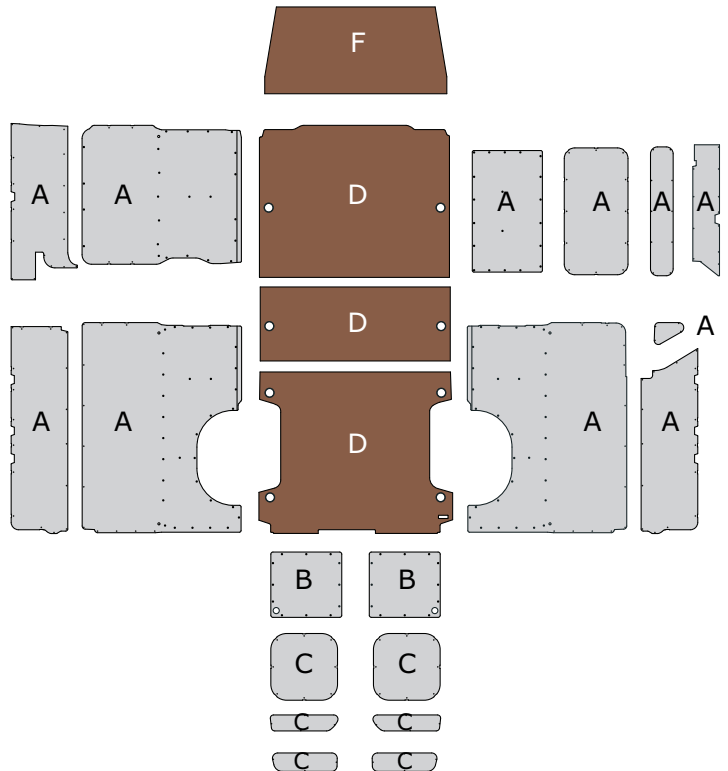
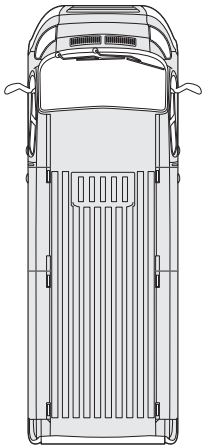

A + B Polypropylene linings Order no. PAN 010

Weight: 23,62 Kg

Polypropylene linings for:

- LH side wall
- RH side wall and sliding door
- lower section of rear leaf doors

Technical
features,
see page 5

C Polypropylene linings Order no. PAR 005

Weight: 2,12 Kg

Polypropylene linings for:

- upper section of rear leaf doors

D Flooring Order no. PIL 007

Weight: 52,08 Kg

12 mm thick wooden flooring phenolic coated and predrilling for lashing hook supports.

F Bulkhead Order no. PIR 003

Weight: 11,24 Kg

12 mm wooden phenolic coated bulkhead panel.



15 m³
L3 H3 wheelbase 4035 mm

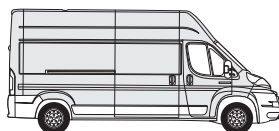

72
BOXER L3 H3
panel van

LOADING RAMP

Order no. RAM 003

Dimensions: **1250x2500 mm** (WxD)
Weight: **116,55 Kg**

Swivel loading ramp.

Load capacity: **1000 Kg**
(p.u.d.)



Technical
features,
see page 8

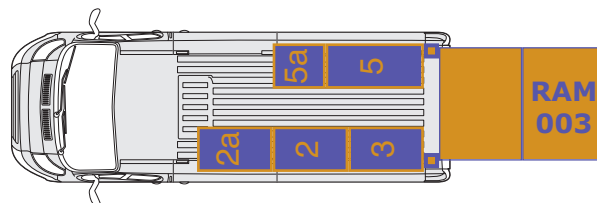

The swivel loading ramp can be installed also when the modules are fitted.

If the loading ramp is fitted, the MDL modules for the area **3** must not be longer than 1016 mm.

If the loading ramp is installed the article **MDL 124 cannot be installed** in area **5**.

It is advisable to ask your nearest STORE VAN distributor for a project feasibility study.

READY SOLUTIONS



Order no. MDL S19

Dimensions: **3257x365x1700 mm** (WxDxH). Weight: **133,95 Kg**

Set of 2 modules complete with:

- 8 trays with rubber and 36 adjustable dividers
- 2 drawers
- 1 shelf with door
- 1 hinged door
- 1 fixing bar length 4000 mm



Order no. MDL S20

Dimensions: **2032x365x1700 mm** (WxDxH). Weight: **60,15 Kg**

Module complete with:

- 4 trays with rubber and 20 adjustable dividers
- 1 fixing bar length 3000 mm

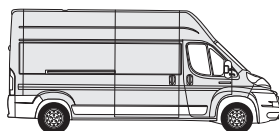

MODULES 717 mm



Suitable to be installed in the zone: **5a**

Order no. MDL 119

Dimensions: **717x365x1700 mm** (WxDxH)

Weight: **38,10 Kg**

Module complete with:

- 4 trays with rubber and 8 adjustable dividers
- 1 shelf with door
- 1 connection bar with fixing belts for tool cases

MODULES 1016 MM



Suitable to be installed in the zone: **2 2a 3 5**

Order no. MDL 114

Dimensions: **1016x365x1700 mm** (WxDxH)

Weight: **62,90 Kg**

Module complete with:

- 4 trays with rubber and 12 adjustable dividers
- 2 drawers
- 1 shelf with door
- 1 hinged door



Suitable to be installed in the zone: **2 2a 3 5**

Order no. MDL 115

Dimensions: **1016x365x1700 mm** (WxDxH)

Weight: **61,80 Kg**

Module complete with:

- 5 trays with rubber and 15 adjustable dividers
- 1 drawer
- 1 retractable shelf for tool cases complete with tool cases and boxes

*approximate measurement

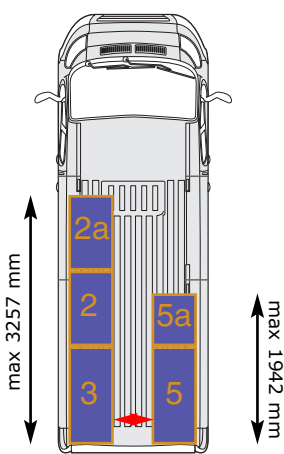

1050 mm*

Suitable to be installed in the zone: **2 2a 3 5**

Order no. MDL 116

Dimensions: **1016x365x1700 mm** (WxDxH)

Weight: **46,70 Kg**

Module complete with:

- 6 trays with rubber and 18 adjustable dividers



Suitable to be installed in the zone: **2 2a**

Order no. MDL 117

Dimensions: **1016x365x1700 mm** (WxDxH)

Weight: **46,50 Kg**

Module complete with:

- 4 trays with rubber and 12 adjustable dividers
- 1 shelf with door
- 1 connection bar with fixing belts for tool cases



Layout example of LH side



Layout example of RH side

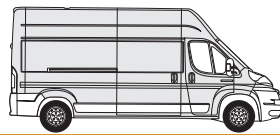

MODULES 1225 MM



Suitable to be installed in the zone: **3 5**

Order no. MDL 120

Dimensions: **1225x365x1700 mm** (WxDxH)

Weight: **72,95 Kg**

Module complete with:

- 4 trays with rubber and 16 adjustable dividers
- 2 drawers
- 1 shelf with door
- 1 hinged door

Suitable to be installed in the zone: **3 5**

Order no. MDL 121

Dimensions: **1225x365x1700 mm** (WxDxH)

Weight: **70,95 Kg**

Module complete with:

- 5 trays with rubber and 20 adjustable dividers
- 1 drawer
- 1 retractable shelf for tool cases complete with tool cases and boxes



Suitable to be installed in the zone: **3 5**

Order no. MDL 122

Dimensions: **1225x365x1700 mm** (WxDxH)

Weight: **55,00 Kg**

Module complete with:

- 6 trays with rubber and 24 adjustable dividers

Suitable to be installed in the zone: **5**

Order no. MDL 124

Dimensions: **1225x365x1700 mm** (WxDxH)

Weight: **82,05 Kg**

Module complete with:

- 6 trays with rubber and 24 adjustable dividers
- 1 retractable vice workbench complete with steel vice with 100 mm jaws and 1/2" to 1 1/2" pipe clamp

Technical features, see page 5

Accessories see page 9



x1

x2

x1

Order no. SFM 350

Fixing bar: **3500x30x35 mm** (WxDxH)

Weight: **2,93 Kg**

Fixing bar for modules, complete with brackets, bolts and screws.

The bar is necessary to fix the modules to the vehicle.

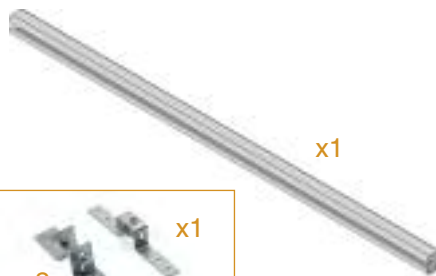

x1

x2

x1

Order no. SFM 250

Fixing bar: **2500x30x35 mm** (WxDxH)

Weight: **2,2 Kg**

Fixing bar for modules, complete with brackets, bolts and screws.

The bar is necessary to fix the modules to the vehicle.



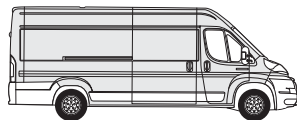

FLOORINGS AND LININGS

for BOXER with RH side sliding door and rear leaf doors, sheet metal side walls

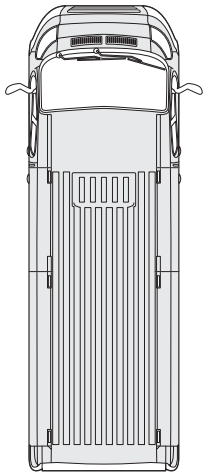

A + B Polypropylene linings Order no. PAN 011

Weight: **23,19 Kg**

Polypropylene linings for:

- LH side wall
- RH side wall and sliding door
- lower section of rear leaf doors

Technical
features,
see page 5

C Polypropylene linings Order no. PAR 004

Weight: **1,75 Kg**

Polypropylene linings for:

- upper section of rear leaf doors

D Flooring Order no. PIL 008

Weight: **57,54 Kg**

12 mm thick wooden flooring phenolic coated and predrilling for lashing hook supports.

F Bulkhead Order no. PIR 003

Weight: **11,24 Kg**

12 mm wooden phenolic coated bulkhead panel.

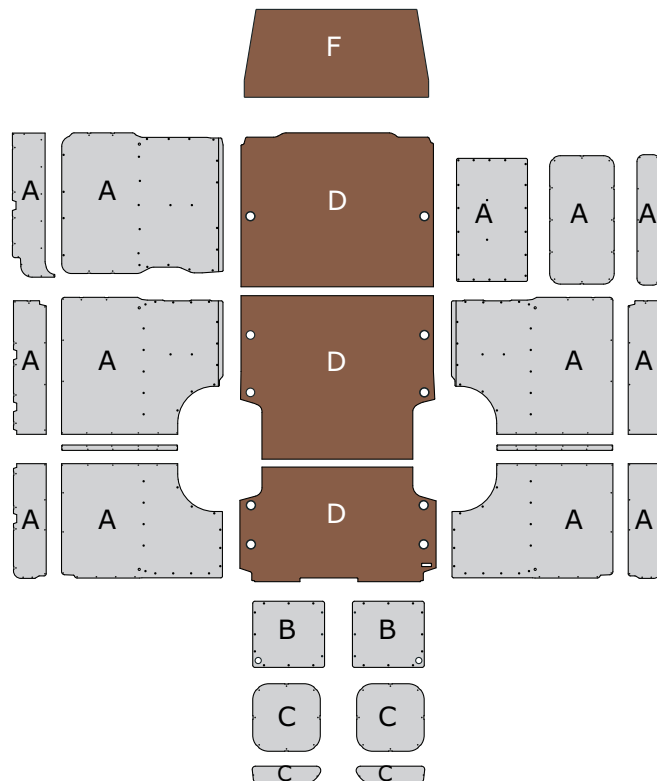

ROOF RACK



Order no. POT 008

Dimensions: **4000x1700 mm** (WxD)

Weight: **39,45 Kg**

Roof rack complete with:

- 5 aluminium crossmembers with fixing connectors and rubber profile
- 2 4000 mm long long aluminium side upstands
- 1 aluminium loading roller

Supplied with **stainless steel** screws for fixing.

Load capacity: 114 Kg (p.u.d.)

Technical
features,
see page 7

LADDER RACK

The ladder rack slide can be mounted on the right or on the left hand side of the vehicle



Order no. POS 010

Dimensions: **4000x1680 mm** (WxD)

Weight: **70,60 Kg**

Ladder rack complete with:

- 5 aluminium crossmembers with fixing connectors and rubber profile
- 1 4000 mm long aluminium side upstand
- 1 aluminium loading roller
- 1 ladder rack rail made from stainless steel and aluminium **ALADIN** series, length 3240 mm
- 1 aluminium connection crossmember

Supplied with **stainless steel** screws for fixing.

Load capacity: 79 Kg (p.u.d.)

15 m³
L3L H2 wheelbase 4035 mm

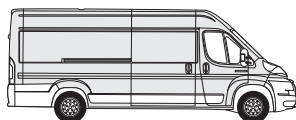

76
BOXER L4 H2
panel van

LOADING RAMP

Order no. RAM 002

Dimensions: **1250x2500 mm** (WxD)

Weight: **116,55 Kg**

Swivel loading ramp.

Load capacity: **1000 Kg**
(p.u.d.)



Technical
features,
see page 8

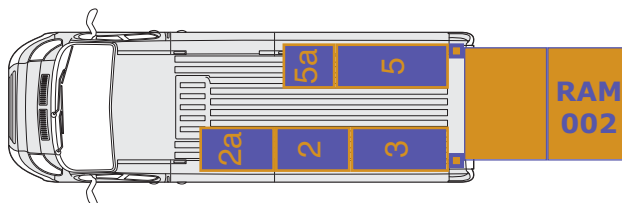

The swivel loading ramp can be installed also when the modules are fitted.

If the loading ramp is fitted, the MDL modules for the area **3** must not be longer than 1225 mm.

If the loading ramp is installed the article **MDL 126 cannot be installed** in area **5**.

It is advisable to ask your nearest STORE VAN distributor for a project feasibility study.

READY SOLUTIONS



MDL S06

Order no. MDL S06

Dimensions: **3765x365x1700 mm** (WxDxH)

Weight: **115,38 Kg**

Set of 2 modules complete with:

- 8 trays with rubber and 40 adjustable dividers,
- 1 fixing bar length 4500 mm



MDL S07

Order no. MDL S07

Dimensions: **1942x365x1700 mm** (WxDxH). Weight: **113,65 Kg**

Set of 2 modules complete with:

- 8 trays with rubber and 24 adjustable dividers, 2 shelves with doors,
- 1 connection bar with fixing belts for tool cases, 2 drawers, 1 hinged door, 1 fixing bar length 3000 mm

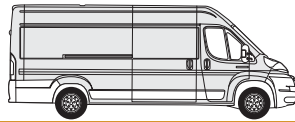

MODULES 717 mm



Suitable to be installed in the zone: **5a**

Order no. MDL 119

Dimensions: **717x365x1700 mm** (WxDxH)

Weight: **38,10 Kg**

Module complete with:

- 4 trays with rubber and 8 adjustable dividers
- 1 shelf with door
- 1 connection bar with fixing belts for tool cases

MODULES 1016 MM



Suitable to be installed in the zone: **2 2a 3 5**

Order no. MDL 114

Dimensions: **1016x365x1700 mm** (WxDxH)

Weight: **62,90 Kg**

Module complete with:

- 4 trays with rubber and 12 adjustable dividers
- 2 drawers
- 1 shelf with door
- 1 hinged door



Suitable to be installed in the zone: **2 2a 3 5**

Order no. MDL 115

Dimensions: **1016x365x1700 mm** (WxDxH)

Weight: **61,80 Kg**

Module complete with:

- 5 trays with rubber and 15 adjustable dividers
- 1 drawer
- 1 retractable shelf for tool cases complete with tool cases and boxes

*approximate measurement

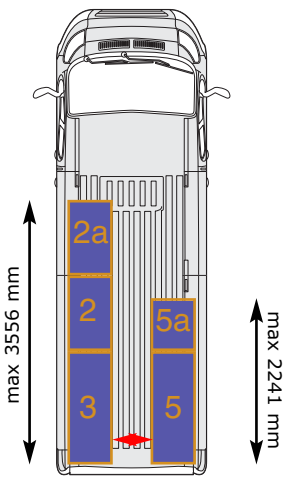

Suitable to be installed in the zone: **2 2a 3 5**

Order no. MDL 116

Dimensions: **1016x365x1700 mm** (WxDxH)

Weight: **46,70 Kg**

Module complete with:

- 6 trays with rubber and 18 adjustable dividers



Suitable to be installed in the zone: **2 2a**

Order no. MDL 117

Dimensions: **1016x365x1700 mm** (WxDxH)

Weight: **46,50 Kg**

Module complete with:

- 4 trays with rubber and 12 adjustable dividers
- 1 shelf with door
- 1 connection bar with fixing belts for tool cases

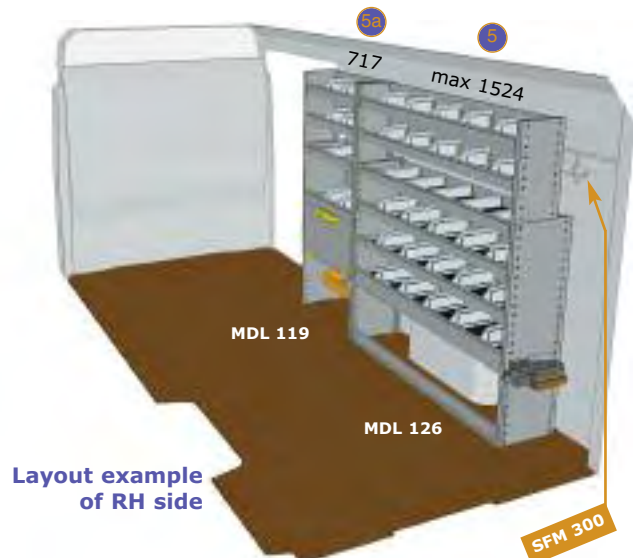
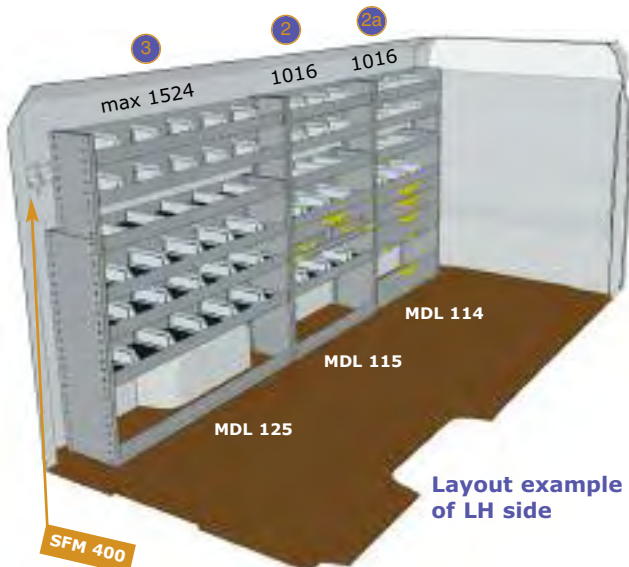

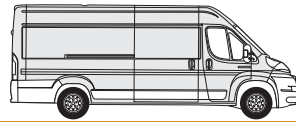

MODULES 1225 MM



Suitable to be installed in the zone: **3 5**

Order no. MDL 120

Dimensions: **1225x365x1700 mm** (WxDxH)

Weight: **72,95 Kg**

Module complete with:

- 4 trays with rubber and 16 adjustable dividers
- 2 drawers
- 1 shelf with door
- 1 hinged door

Suitable to be installed in the zone: **3 5**

Order no. MDL 121

Dimensions: **1225x365x1700 mm** (WxDxH)

Weight: **70,95 Kg**

Module complete with:

- 5 trays with rubber and 20 adjustable dividers
- 1 drawer
- 1 retractable shelf for tool cases complete with tool cases and boxes



Suitable to be installed in the zone: **3 5**

Order no. MDL 122

Dimensions: **1225x365x1700 mm** (WxDxH)

Weight: **55,00 Kg**

Module complete with:

- 6 trays with rubber and 24 adjustable dividers

MODULES 1524 MM



Suitable to be installed in the zone: **3 5**

Order no. MDL 125

Dimensions: **1524x365x1700 mm** (WxDxH)

Weight: **65,35 Kg**

Module complete with:

- 6 trays with rubber and 30 adjustable dividers



Suitable to be installed in the zone: **5**

Order no. MDL 126

Dimensions: **1524x365x1700 mm** (WxDxH)

Weight: **104,80 Kg**

Module complete with:

- 6 trays with rubber and 30 adjustable dividers
- 1 retractable vice workbench complete with steel vice with 100 mm jaws and 1/2" to 1 1/2" pipe clamp

Technical features, see page 5

Accessories see page 9



x1



x2

x2

Order no. SFM 400

Fixing bar: **4000x30x35 mm** (WxDxH)

Weight: **3,45 Kg**

Fixing bar for modules, complete with brackets, bolts and screws.

The bar is necessary to fix the modules to the vehicle.



x1



x2

x1

Order no. SFM 300

Fixing bar: **3000x30x35 mm** (WxDxH)

Weight: **2,60 Kg**

Fixing bar for modules, complete with brackets, bolts and screws.

The bar is necessary to fix the modules to the vehicle.

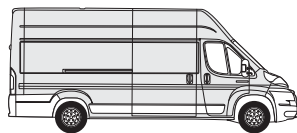

FLOORINGS AND LININGS

for BOXER with RH side sliding door and rear leaf doors, sheet metal side walls

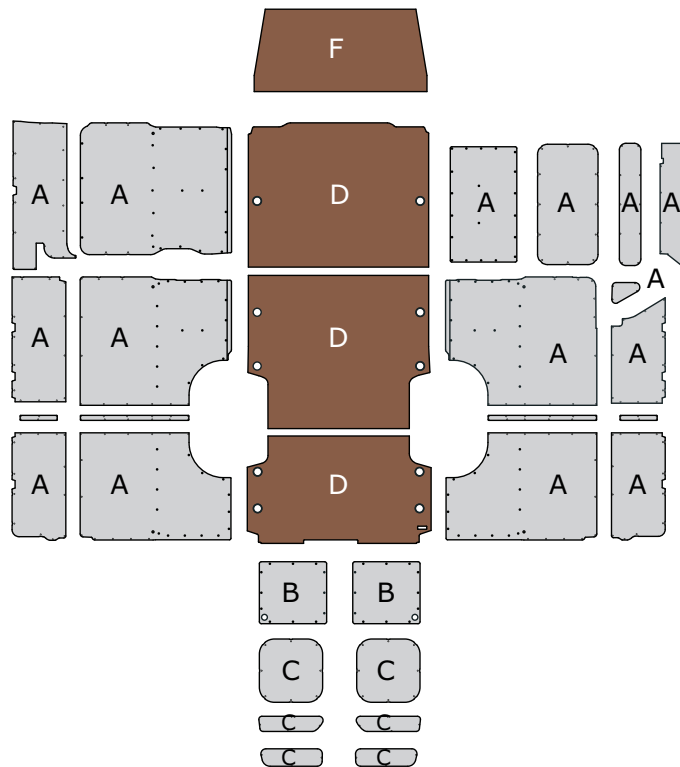
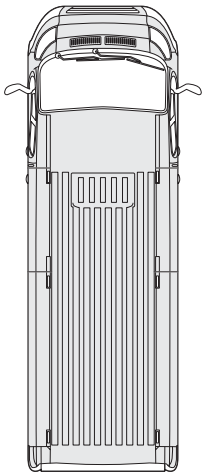

A + B Polypropylene linings Order no. PAN 012

Weight: 25,92 Kg

Polypropylene linings for:

- LH side wall
- RH side wall and sliding door
- lower section of rear leaf doors

Technical
features,
see page 5

C Polypropylene linings Order no. PAR 005

Weight: 2,12 Kg

Polypropylene linings for:

- upper section of rear leaf doors

D Flooring Order no. PIL 008

Weight: 57,54 Kg

12 mm thick wooden flooring phenolic coated and predrilling for lashing hook supports.

F Bulkhead Order no. PIR 003

Weight: 11,24 Kg

12 mm wooden phenolic coated bulkhead panel.



17 m³
L3L H3 wheelbase 4035 mm



80
BOXER L4 H3
panel van

LOADING RAMP

Order no. RAM 003

Dimensions: **1250x2500 mm** (WxD)
Weight: **116,55 Kg**

Swivel loading ramp.

Load capacity: 1000 Kg
(p.u.d.)



Technical
features,
see page 8

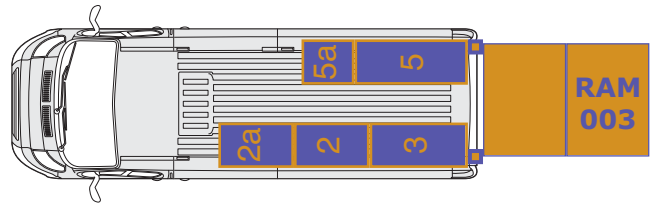

The swivel loading ramp can be installed also when the modules are fitted.

If the loading ramp is fitted, the MDL modules for the area **3** must not be longer than 1225 mm.

If the loading ramp is installed the article **MDL 126 cannot be installed** in area **5**.

It is advisable to ask your nearest STORE VAN distributor for a project feasibility study.

READY SOLUTIONS



Order no. MDL S06

Dimensions: **3765x365x1700 mm** (WxDxH)
Weight: **115,38 Kg**

Set of 2 modules complete with:

- 8 trays with rubber and 40 adjustable dividers,
- 1 fixing bar length 4500 mm



Order no. MDL S07

Dimensions: **1942x365x1700 mm** (WxDxH). Weight: **113,65 Kg**

Set of 2 modules complete with:

- 8 trays with rubber and 24 adjustable dividers, 2 shelves with doors,
- 1 connection bar with fixing belts for tool cases, 2 drawers, 1 hinged door, 1 fixing bar length 3000 mm



MODULES 717 mm



Suitable to be installed in the zone: **5a**

Order no. MDL 119

Dimensions: **717x365x1700 mm** (WxDxH)

Weight: **38,10 Kg**

Module complete with:

- 4 trays with rubber and 8 adjustable dividers
- 1 shelf with door
- 1 connection bar with fixing belts for tool cases

MODULES 1016 MM



Suitable to be installed in the zone: **2 2a 3 5**

Order no. MDL 114

Dimensions: **1016x365x1700 mm** (WxDxH)

Weight: **62,90 Kg**

Module complete with:

- 4 trays with rubber and 12 adjustable dividers
- 2 drawers
- 1 shelf with door
- 1 hinged door



Suitable to be installed in the zone: **2 2a 3 5**

Order no. MDL 115

Dimensions: **1016x365x1700 mm** (WxDxH)

Weight: **61,80 Kg**

Module complete with:

- 5 trays with rubber and 15 adjustable dividers
- 1 drawer
- 1 retractable shelf for tool cases complete with tool cases and boxes

*approximate measurement

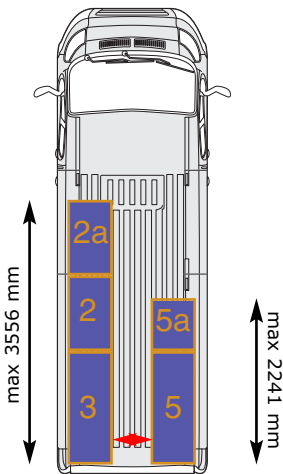

1050 mm*



Suitable to be installed in the zone: **2 2a 3 5**

Order no. MDL 116

Dimensions: **1016x365x1700 mm** (WxDxH)

Weight: **46,70 Kg**

Module complete with:

- 6 trays with rubber and 18 adjustable dividers



Suitable to be installed in the zone: **2 2a**

Order no. MDL 117

Dimensions: **1016x365x1700 mm** (WxDxH)

Weight: **46,50 Kg**

Module complete with:

- 4 trays with rubber and 12 adjustable dividers
- 1 shelf with door
- 1 connection bar with fixing belts for tool cases

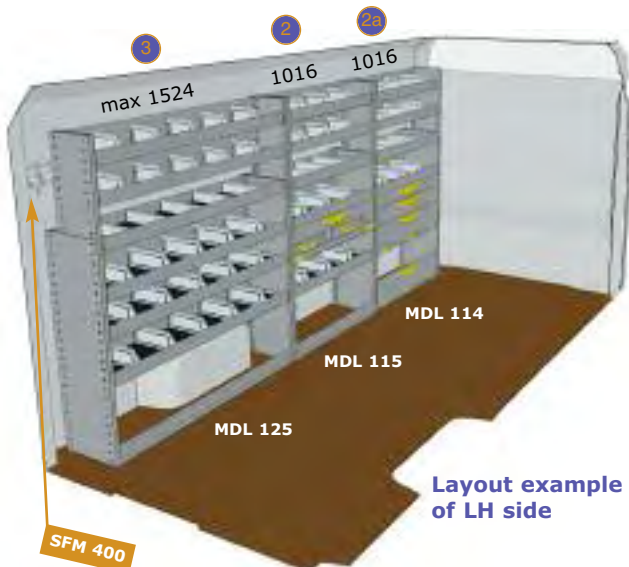

Layout example of LH side

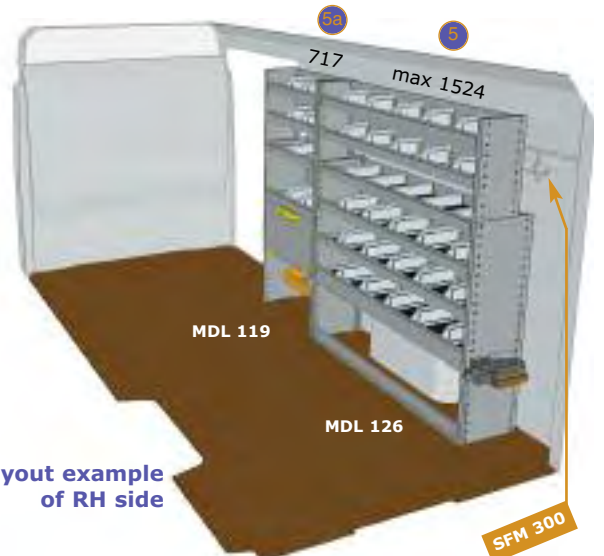

Layout example of RH side



MODULES 1225 MM

MODULES 1524 MM



Suitable to be installed in the zone: **3 5**

Order no. MDL 120

Dimensions: **1225x365x1700 mm** (WxDxH)

Weight: **72,95 Kg**

Module complete with:

- 4 trays with rubber and 16 adjustable dividers
- 2 drawers
- 1 shelf with door
- 1 hinged door

Suitable to be installed in the zone: **3 5**

Order no. MDL 121

Dimensions: **1225x365x1700 mm** (WxDxH)

Weight: **70,95 Kg**

Module complete with:

- 5 trays with rubber and 20 adjustable dividers
- 1 drawer
- 1 retractable shelf for tool cases complete with tool cases and boxes

Suitable to be installed in the zone: **3 5**

Order no. MDL 125

Dimensions: **1524x365x1700 mm** (WxDxH)

Weight: **65,35 Kg**

Module complete with:

- 6 trays with rubber and 30 adjustable dividers



Suitable to be installed in the zone: **3 5**

Order no. MDL 122

Dimensions: **1225x365x1700 mm** (WxDxH)

Weight: **55,00 Kg**

Module complete with:

- 6 trays with rubber and 24 adjustable dividers

Suitable to be installed in the zone: **5**

Order no. MDL 126

Dimensions: **1524x365x1700 mm** (WxDxH)

Weight: **104,80 Kg**

Module complete with:

- 6 trays with rubber and 30 adjustable dividers
- 1 retractable vice workbench complete with steel vice with 100 mm jaws and 1/2" to 1 1/2" pipe clamp

Technical features, see page 5

Accessories see page 9



x1



x2

x2

Order no. SFM 400

Fixing bar: **4000x30x35 mm** (WxDxH)

Weight: **3,45 Kg**

Fixing bar for modules, complete with brackets, bolts and screws.

The bar is necessary to fix the modules to the vehicle.



x1



x2

x1

Order no. SFM 300

Fixing bar: **3000x30x35 mm** (WxDxH)

Weight: **2,60 Kg**

Fixing bar for modules, complete with brackets, bolts and screws.

The bar is necessary to fix the modules to the vehicle.



FAMI S.r.l.
 Via Stazione Rossano 13
 36027 Rosà, Vicenza ITALY
 Tel. +39 0424 585455
 fax +39 0424 585482
www.storevan.com
info@storevan.com

YOUR STORE VAN PARTNER



**PROFESSIONALITY
 IN MOVEMENT**