

# Fittings for commercial vehicles

# Volkswagen

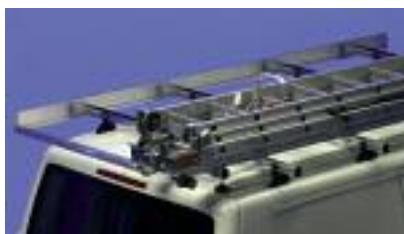

PROFESSIONALITY IN MOVEMENT

## TERMS OF SUPPLY

- Floorings and linings supplied in several parts.
- Floorings, linings, roof racks and ladder racks are supplied **unassembled**.
- Modules are supplied **pre-assembled** complete with fixing material to the vehicle.
- For **product installation** we suggest to contact the expert assistance of our network of **authorised installation centers** (see back cover).
- The products are supplied including **packing**.
- Our products are covered by a **3-years warranty**.
- **Load capacity** data refer to **uniformly distributed loads** (p.u.d.)

## CERTIFIED PRODUCTION

Successfully certified, Quality Assurance Certification since over ten years.



## CRASH TEST STORE VAN



Passed the **CRASH TEST** carried out according to the recent European regulations. **ECE-R17** with impact at **50 Km/h**.



## TESTED AND CERTIFIED SAFETY



**S**TORE VAN has obtained the prestigious **GS** certification for its loading ramps and interior fittings.



**S**TORE VAN also boasts the rare **GS** certification for the universal ladder rack.

## Store Van

A TRADEMARK OF FAMI'S GROUP

Fami's constant focus on the market trends, combined with studies for customized products, has been the winning strategy also for the last born brand name – STORE VAN - which offers fittings for commercial vehicles of all types. The accurate designed modules and the perfect adaptability for the most different personalised projects, confirmed the quality and supremacy of Store Van's components.

The achieved success allowed Store Van to become one of the most reliable and popular supplier among the international commercial vehicles producers.



PROFESSIONALITY IN MOVEMENT

Store Van first introduced an innovative installation system without drilling the van bodyworks to fix the equipments, guaranteeing functionality, quality, steadiness and aesthetic features, both for estate cars and for large vans and fleets.

## LOGISTIC QUALITY SYSTEMS

Fami's strategy develops through products versatility, while each project becomes exclusive and customised. This strategy, along with advanced industrial processes, originates fitting systems suitable to meet all customers' requirements.

Fami, one of the leading Company in the field of industrial storage systems, gives priority to the technological features but also considers the design and the "soul" of the product, signing each article with a perfect balance of technology and "heart".

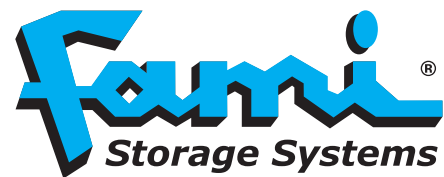

Fami stands out for its high technology and original solutions, like industrial storage, work stations and conductive systems for the electronic industry. All Company's advanced solutions can be employed and diversified in different applications, becoming Fami the leading Company in its field as far competence and competitiveness.



	MODEL	VEHICLE DATA	PAGE
	Caddy Caddy Maxi		15-22
	Transporter short wheelbase low roof	5,8 m <sup>3</sup> L1 H1 wheelbase 3000 mm height 1959 mm	27-30
	Transporter short wheelbase medium roof	6,7 m <sup>3</sup> L1 H2 wheelbase 3000 mm height 2160 mm	27-30
	Transporter long wheelbase low roof	6,7 m <sup>3</sup> L2 H1 wheelbase 3400 mm height 1959 mm	31-34
	Transporter long wheelbase medium roof	7,8 m <sup>3</sup> L2 H2 wheelbase 3400 mm height 2160 mm	31-34
	Crafter 30/35 short wheelbase low roof	7,5 m <sup>3</sup> L1 H1 wheelbase 3250 mm height 2415 mm	39-42
	Crafter 30/35/50 medium wheelbase low roof	9 m <sup>3</sup> L2 H1 wheelbase 3665 mm height 2415-2470 mm	43-46
	Crafter 30/35/50 medium wheelbase high roof	11 m <sup>3</sup> L2 H2 wheelbase 3665 mm height 2705-2755 mm	47-50
	Crafter 35/50 medium wheelbase extra high roof	11,5 m <sup>3</sup> L2 H3 wheelbase 3665 mm height 2940-2990 mm	51-54
	Crafter 35/50 long wheelbase high roof	14 m <sup>3</sup> L3 H2 wheelbase 4325 mm height 2705-2755 mm	55-58
	Crafter 35/50 long wheelbase extra high roof	15 m <sup>3</sup> L3 H3 wheelbase 4325 mm height 2940-2990 mm	59-62
	Crafter 35/50 long wheelbase extended rear overhang high roof	15,5 m <sup>3</sup> L3L H2 wheelbase 4325 mm height 2705-2755 mm	63-66
	Crafter 35/50 long wheelbase extended rear overhang extra high roof	17 m <sup>3</sup> L3L H3 wheelbase 4325 mm height 2940-2990 mm	67-70





## LININGS

**4** mm thick polypropylene honeycomb linings with scratchproof surface. Lightweight and robust.



## FLOORINGS

**P**re-shaped loading floors in one or more jointed pieces with extruded aluminium inserts. Made of 12 mm thick birch and conifer phenolic multi-ply, resin-bonded on both faces and a wear-resistant and slip-proof surface treatment.



## DRAWERS

**E**asy and intuitive one hand opening with handle operated opening and closing safety stop. Wide range of dividing options of the drawers by means of plastic or metal accessories.

**Load capacity:** 50 Kg



## RETRACTABLE SHELVES

**R**etractable shelves for one or two tool cases with the possibility of introducing tool cases with different heights and depths.

**Load capacity:** 50 Kg



## VICE WORKBENCH

**R**etractable vice workbench complete with steel vice, swivel base, jaws width 100 mm.



## Technical features

**TALENTO** ladder rack rails with **lowering system** with brake for ladders weight up to 60 kg.



**ALADIN** ladder rack rails with **servo-assisted lowering and lifting system** for ladders weight up to 60 kg.





## LOADING RAMPS



Servo assisted loading ramps with tubular steel structure and knurled slip-proof aluminium platform. Connection to the vehicle by means of a telescopic column and self-positioning feet.

**Load capacity from:** 600 to 1500 Kg.



## 292 mm DEEP TOOL CASES

**Order no. VAL 001****Case with boxes**

Dim. 438x292x67 mm (WxDxH)  
Internal solutions with:  
2 green, 2 blue, 5 yellow,  
10 red boxes.

**Order no. VAL 002****Case with boxes**

Dim. 438x292x67 mm (WxDxH)  
Internal solutions with: 8 blue,  
8 red boxes.

**Order no. VAL 003****Case with boxes**

Dim. 438x292x102 mm (WxDxH)  
Internal solutions with: 2 blue,  
2 green, 5 yellow, 10 red boxes.  
Upper tray with 20 red and 10  
yellow boxes.

**Order no. VAL 004****Case with boxes**

Dim. 438x292x102 mm (WxDxH)  
Internal solutions with:  
4 green, 4 blue boxes.  
Upper tray with 20 red and  
10 yellow boxes.

## 343 mm DEEP TOOL CASES

**Order no. VAL 005****Case with boxes**

Dim. 438x343x67 mm (WxDxH)  
Internal solutions with:  
2 green, 3 blue, 6 yellow,  
12 red boxes.

**Order no. VAL 006****Case with boxes**

Dim. 438x343x67 mm (WxDxH)  
Internal solutions with:  
8 green boxes.

**Order no. VAL 007****Case with boxes**

Dim. 438x343x102 mm (WxDxH)  
Internal solutions with:  
2 green, 3 blue, 6 yellow, 12 red  
boxes.  
Upper tray with 24 red and 12  
yellow boxes.

**Order no. VAL 008****Case with boxes**

Dim. 438x343x102 mm (WxDxH)  
Internal solutions with:  
12 blue boxes.  
Upper tray with 24 red and 12  
yellow boxes.

## ACCESSORIES FOR MODULES



**Order no. ACS 001**  
Hand washing kit



**Order no. ACS 002**  
Can holder kit with 20  
litres capacity metal can



**Order no. ACS 003**  
Supports with belt  
strap for gas cylinders  
and extinguishers



**Order no. ACS 004**  
First aid kit



**Order no. ACS 005**  
Paper towel holder kit  
with paper towel  
Ø 140 mm



**Order no. ACS 006**  
DIN A4 document  
holder



**Order no. ACS 007**  
Spray-can holder kit



**Order no. ACS 008**  
Painted aluminium  
cable saddles

## LOAD RETAINING BARS AND BELTS



Load retaining bar kit available in 3 dimensions:

**Order no. ACS 009**  
Load retaining bar length 1000 mm  
Pair of polyester belts length 3260 mm

**Order no. ACS 010**  
Load retaining bar length 1500 mm  
Pair of polyester belts length 3260 mm

**Order no. ACS 011**  
Load retaining bar length 2000 mm  
Pair of polyester belts length 3260 mm



## CRANES



**R**evolving crane with positioning brake and folding arm. Including 12 V motor and lifting hook sliding on an aluminium guide and electric limit switch, equipped with remote control with cable.

**Load capacity from:** 150 to 190 Kg.

**OPTIONAL ACCESSORY NOT AVAILABLE FOR ALL VEHICLES MODELS**

## COMPRESSORS AND RETRACTABLE HORIZONTAL SYSTEMS



**R**etractable horizontal aluminium frames. Mechanical stop of the frame in opening and closing.

Possibility of blocking the shelf in any opening position.

**Load capacity:** 300 Kg.

**Extraction:** 60 %

**V**ertical compressors 220V - 380V.

**Capacity:** 50 - 100 LT



## COLLAPSIBLE VICE WORKBENCHES



**C**ollapsible vice workbenches with floor support.

Work bench height adjustable.

**Top width:** 240 / 340 mm

**Depth:** 1150 mm



## LIFTING DOORS



**L**ifting doors with assisted opening.

**Length:** 508 / 717 / 1016 / 1225 / 1524 mm

**Useful height:** 350 / 400 mm



## SHELVES



**S**helves available for modules:

**Length:** 508 / 717 / 1016 / 1225 / 1524 mm

**Depth:** 265 / 365 mm

**Front height:** 35 mm

**Back height:** 100 mm

Available with or without polypropylene containers

# Strategically strong



## Caddy - 3,2 m<sup>3</sup>

### Vehicle equipped with:

1	ord. no. POS 101	ladder rack (ladder not supplied)
1	ord. no. PIL 101	wooden flooring
1	ord. no. PAN 101	polypropylene lining
1	ord. no. MDL 003	module
1	ord. no. MDL 007	module
1	ord. no. ACS 007	spray cans holder kit
1	ord. no. ACS 003	support with belt for gas cylinders and extinguishers (extinguisher not supplied)

- › **FAST ASSEMBLY**
- › **TOTAL MODULARITY**
- › **SAFETY SOUND ABSORBING ELEMENTS BETWEEN THE VARIOUS METAL COMPONENTS**
- › **ERGONOMETRIC SHAPES**
- › **HEIGHT ADJUSTMENT IN PITCH OF 25 mm OF THE VARIOUS ELEMENTS**





# Caddy



## FLOORINGS AND LININGS

for Caddy with RH side sliding door and rear leaf doors, sheet metal side walls, remote control lock\*

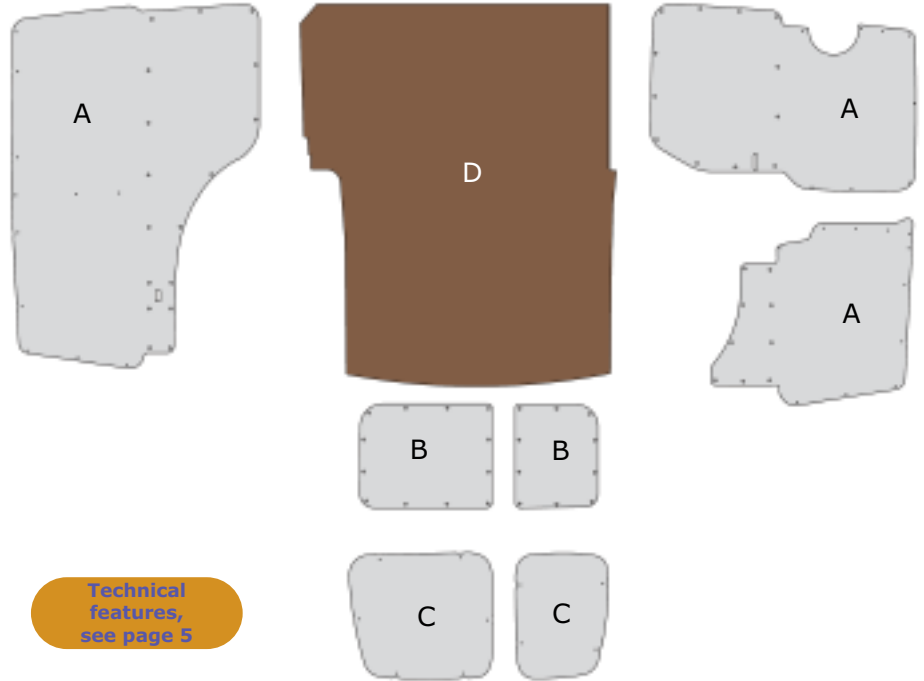
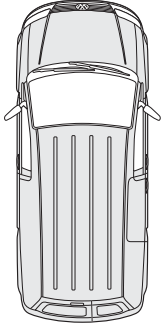

### A + B Polypropylene linings Order no. PAN 101

Weight: **5,73 Kg**

**Polypropylene linings for:**

- LH side wall
- RH side wall and sliding door
- lower section of rear leaf doors

Technical features,  
see page 5

### C Polypropylene linings Order no. PAR 101

Weight: **0,96 Kg**

**Polypropylene linings for:**

- upper section of rear leaf doors

### D Flooring Order no. PIL 101

Weight: **17,26 Kg**

**12 mm thick wooden load flooring phenolic coated.**

\*For versions **without remote control lock** contact your nearest STORE VAN distributor.

## ROOF RACK



### Order no. POT 101

Dimensions: **2000x1400 mm** (WxD)

Weight: **19,70 Kg**

**Roof rack** complete with:

- 2 aluminium crossmembers with fixing connectors and rubber profile
- 1 additional crossmember with supports
- 2 2000 mm long aluminium side upstands
- 1 aluminium loading roller

Supplied with **stainless steel** screws for fixing.

**Load capacity: 81 Kg (p.u.d.)**

**ROOF RACK** only for Caddy with rear leaf doors

Technical features,  
see page 5

## LADDER RACK

The ladder rack rail can be mounted on the right or on the left hand side of the vehicle.



### Order no. POS 101

Dimensions: **2110x1380 mm** (WxD)

Weight: **41,40 Kg**

**Ladder rack** complete with:

- 2 aluminium crossmembers with fixing connectors and rubber profile
- 1 additional crossmember with supports
- 1 2000 mm long aluminium side upstand
- 1 aluminium loading roller
- 1 ladder rack rail made from stainless steel and aluminium **TALENTO** series, length 2110 mm

Supplied with **stainless steel** screws for fixing.

**Load capacity: 59 Kg (p.u.d.)**

**LADDER RACK** only for Caddy with rear leaf doors



Technical features,  
see page 5

Accessories  
see page 9

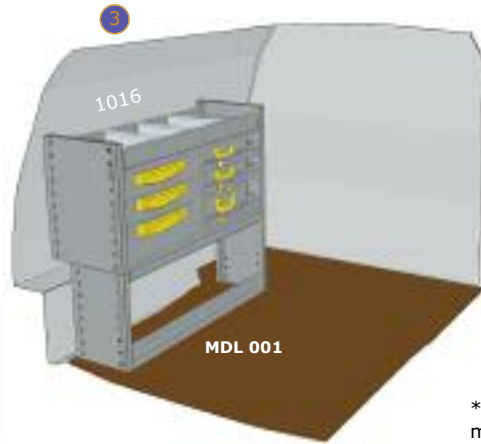

Layout example of LH side

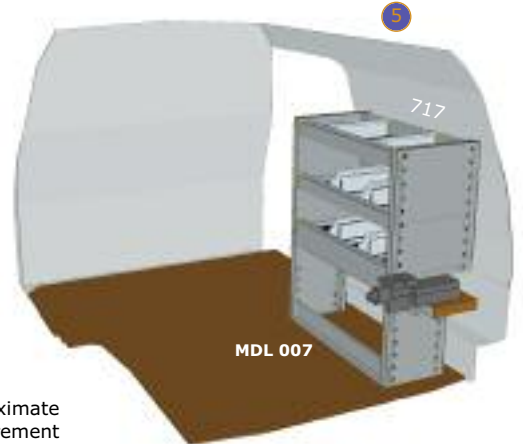

Layout example of RH side

\*approximate  
measurement



Suitable to be installed in the zone: **3**

**Order no. MDL 001**

Dimensions: **1016x365x900 mm** (WxDxH)

Weight: **61 Kg**

Module complete with:

- 1 tray with rubber and 3 adjustable dividers
- 3 drawers
- 3 retractable shelves for tool cases complete with tool cases and boxes

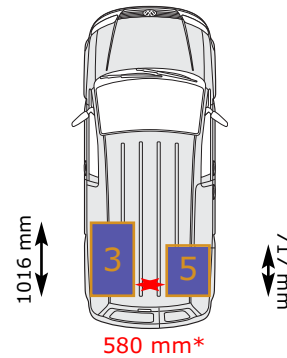

Suitable to be installed in the zone: **3**

**Order no. MDL 002**

Dimensions: **1016x365x900 mm** (WxDxH)

Weight: **43,8 Kg**

Module complete with:

- 1 tray with rubber and 3 adjustable dividers
- 2 drawers
- 1 shelf with door
- 1 hinged door



Suitable to be installed in the zone: **3**

**Order no. MDL 003**

Dimensions: **1016x365x900 mm** (WxDxH)

Weight: **52,2 Kg**

Module complete with:

- 2 trays with rubber and 4 adjustable dividers
- 1 drawer
- 3 retractable shelves for tool cases complete with tool cases and boxes



Suitable to be installed in the zone: **3**

**Order no. MDL 004**

Dimensions: **1016x365x900 mm** (WxDxH)

Weight: **28,8 Kg**

Module complete with:

- 3 trays with rubber and 9 adjustable dividers



Suitable to be installed in the zone: **5**

**Order no. MDL 005**

Dimensions: **717x365x900 mm** (WxDxH)

Weight: **32,9 Kg**

Module complete with:

- 1 tray with rubber and 2 adjustable dividers
- 2 drawers
- 1 shelf with door



Suitable to be installed in the zone: **5**

**Order no. MDL 006**

Dimensions: **717x365x900 mm** (WxDxH)

Weight: **22,7 Kg**

Module complete with:

- 3 trays with rubber and 6 adjustable dividers



Suitable to be installed in the zone: **5**

**Order no. MDL 007**

Dimensions: **717x365x900 mm** (WxDxH)

Weight: **42,7 Kg**

Module complete with:

- 3 trays with rubber and 6 adjustable dividers
- 1 retractable vice workbench complete with steel vice with 100 mm jaws and 1/2" to 1 1/2" pipe clamp





## VERTICAL RETRACTABLE SYSTEMS DOUBLE LEVEL FLOOR



The vertical retractable systems and drawers placed under the loading floor make it easier to take out the stored material

Detail of the drawer installed by the right hand side door



3,2 m<sup>3</sup>  
L1 H1 wheelbase 2682 mm



### Vertical retractable system

#### Order no. PEV 101

Vertical retractable systems with module for double level floor kit

Dimensions: **1234x455x860 mm** (WxDxH)

Weight: **49 Kg**

System complete with:

- 1 vertical frame, extraction 50% load capacity 100 Kg, extraction 70% load capacity 75 Kg
- 1 module with 3 trays with rubber and 12 adjustable dividers

### THE VERTICAL RETRACTABLE SYSTEM

can only be mounted together with the double level floor kit.

### Double level floor kit

#### Order no. MPR 101

Dimensions: **1482x1638x267 mm** (WxDxH)

Weight: **100,35 Kg**

Kit complete with:

- 1 12 mm thick wooden flooring phenolic coated
- 2 drawer cabinets with 4 drawers complete of partitioning material, internal dimensions of the drawers: 447x600x86 mm h
- 1 drawer cabinet with 1 drawer complete of partitioning material, internal dimensions of the drawer: 447x600x186 mm h

### DOUBLE LEVEL FLOOR KIT

only for Caddy with rear leaf doors and right hand side sliding door.



Detail of 2 drawers with useful height 86 mm, standard supplied with:  
12 plastic boxes 150x150x71 mm h  
24 plastic boxes 75x150x71 mm h



Detail of 2 drawers with useful height 86 mm, standard supplied with:  
5 multi-purpose supports

Detail of drawer with useful height 186 mm, standard supplied with:  
1 longitudinal divider  
2 adjustable transversal dividers







## VERTICAL RETRACTABLE SYSTEMS



### Vertical retractable system

#### Order no. PEV 102

#### Vertical retractable system with module

Dimensions: 1234x355x1110 mm (WxDxH)

Weight: 55,9 Kg

Panel complete with:

- 1 vertical frame, extraction 50% load capacity 100 Kg, extraction 70% load capacity 75 Kg
- 1 module with 4 trays with rubber and 16 adjustable dividers

**THE VERTICAL RETRACTABLE SYSTEM can only be mounted together with the wooden flooring order no. PIL 101**



**The vertical retractable system makes it easier to take out the stored material**



### Module

#### Order no. MDL 006

Dimensions: 717x365x900 mm (WxDxH)

Weight: 22,7 Kg

Module complete with:

- 3 trays with rubber and 6 adjustable dividers



3,2 m<sup>3</sup>  
L1 H1 wheelbase 2682 mm



## HORIZONTAL RETRACTABLE SYSTEMS



990 mm

### Horizontal retractable system

#### Order no. PEO 101

Dimensions: **1080x1524x80 mm** (WxDxH)

Weight: **71,25 Kg**

System complete with:

- 1 wooden flooring phenolic coated with holes for fixing the extractable frame
- 1 horizontal extractable frame extension 60% load capacity 300 Kg complete with a phenolic wooden top and rubber cover
- 8 lashing hooks supports for load retaining belt
- 2 load retaining belts



The horizontal retractable systems makes it easier to anchor the material transported and makes loading, unloading operations simpler



## FLOORINGS AND LININGS

for Caddy with RH side sliding door and rear leaf doors, sheet metal side walls, remote control lock\*

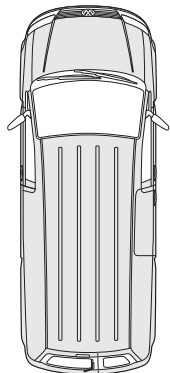

Technical features, see page 5

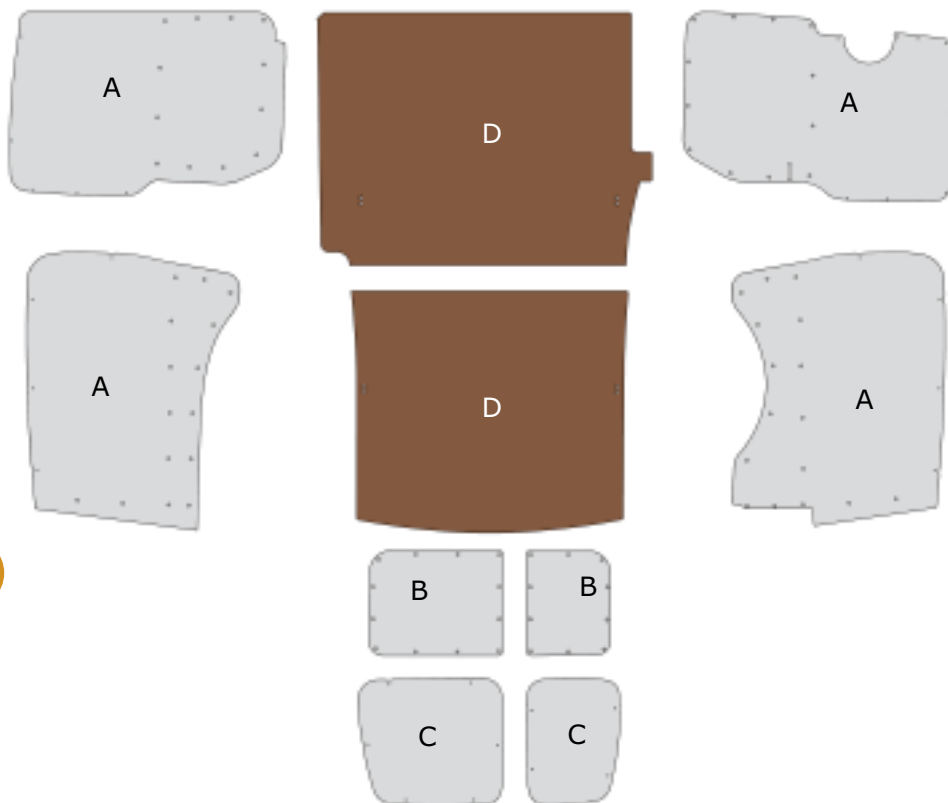

### A + B Polypropylene linings

Order no. PAN 118

Weight: 7,50 Kg

Polypropylene linings for:

- LH side wall
- RH side wall and sliding door
- lower section of rear leaf doors

### C Polypropylene linings

Order no. PAR 101

Weight: 0,96 Kg

Polypropylene linings for:

- upper section of rear leaf doors

### D Flooring

Order no. PIL 114

Weight: 22,15 Kg

12 mm thick wooden load flooring phenolic coated.

\*For versions **without remote control lock** contact your nearest STORE VAN distributor.

## ROOF RACK



ROOF RACK only for Caddy with rear leaf doors

### Order no. POT 112

Dimensions: 2500x1400 mm (WxD)

Weight: 24,80 Kg

Roof rack complete with:

- 3 aluminium crossmembers with fixing connectors and rubber profile
- 1 additional crossmember with supports
- 2 2500 mm long aluminium side upstands
- 1 aluminium loading roller

Supplied with **stainless steel** screws for fixing.

Load capacity: 76 Kg (p.u.d.)

## LADDER RACK

The ladder rack rail can be mounted on the right or on the left hand side of the vehicle.



LADDER RACK only for Caddy with rear leaf doors

Technical features, see page 7

### Order no. POS 112

Dimensions: 2650x1380 mm (WxD)

Weight: 49 Kg

Ladder rack complete with:

- 3 aluminium crossmembers with fixing connectors and rubber profile
- 1 additional crossmember with supports
- 1 2500 mm long aluminium side upstand
- 1 aluminium loading roller
- 1 ladder rack rail made from stainless steel and aluminium TALENTO series, length 2650 mm

Supplied with **stainless steel** screws for fixing.

Load capacity: 51 Kg (p.u.d.)

4,2 m<sup>3</sup>  
L2 H1 wheelbase 3002 mm



Technical features,  
see page 5

Accessories  
see page 9

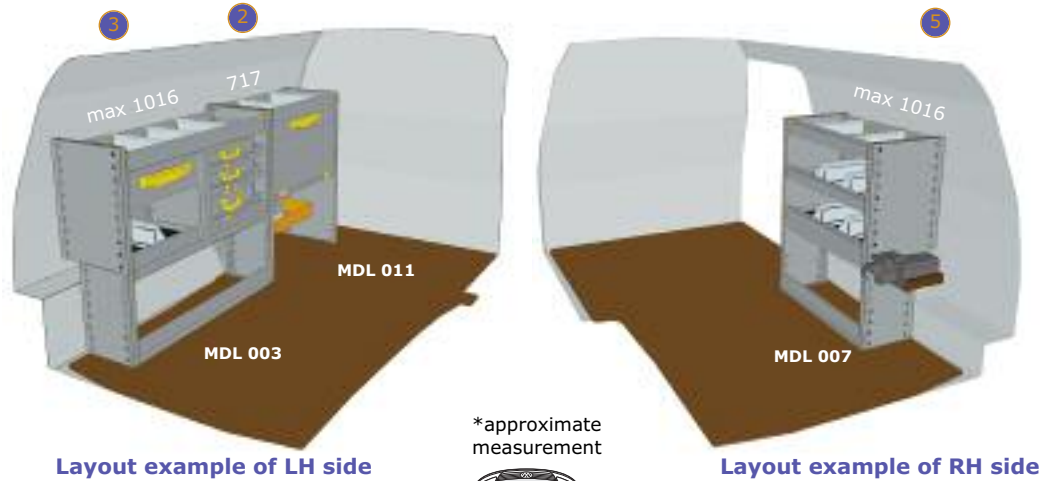

Layout example of LH side

Layout example of RH side



Suitable to be installed in the zone: **2**

### Order no. MDL 011

Dimensions: **717x365x900 mm** (WxDxH)

Weight: **20 Kg**

Module complete with:

- 1 tray with rubber and 2 adjustable dividers
- 1 shelf with door
- 1 connection bar with fixing belts for tool cases



Suitable to be installed in the zone: **3 5**

### Order no. MDL 002

Dimensions: **1016x365x900 mm** (WxDxH)

Weight: **43,8 Kg**

Module complete with:

- 1 tray with rubber and 3 adjustable dividers
- 2 drawers
- 1 shelf with door
- 1 hinged door



Suitable to be installed in the zone: **3 5**

### Order no. MDL 003

Dimensions: **1016x365x900 mm** (WxDxH)

Weight: **52,2 Kg**

Module complete with:

- 2 trays with rubber and 4 adjustable dividers
- 1 drawer
- 3 retractable shelves for tool cases complete with tool cases and boxes



Suitable to be installed in the zone: **3 5**

### Order no. MDL 004

Dimensions: **1016x365x900 mm** (WxDxH)

Weight: **28,8 Kg**

Module complete with:

- 3 trays with rubber and 9 adjustable dividers



Suitable to be installed in the zone: **3 5**

### Order no. MDL 005

Dimensions: **717x365x900 mm** (WxDxH)

Weight: **32,9 Kg**

Module complete with:

- 1 tray with rubber and 2 adjustable dividers
- 2 drawers
- 1 shelf with door



Suitable to be installed in the zone: **3 5**

### Order no. MDL 006

Dimensions: **717x365x900 mm** (WxDxH)

Weight: **22,7 Kg**

Module complete with:

- 3 trays with rubber and 6 adjustable dividers



Suitable to be installed in the zone: **5**

### Order no. MDL 007

Dimensions: **717x365x900 mm** (WxDxH)

Weight: **42,7 Kg**

Module complete with:

- 3 trays with rubber and 6 adjustable dividers
- 1 retractable vice workbench complete with steel vice with 100 mm jaws and 1/2" to 1 1/2" pipe clamp



# Strategically strong



## Transporter L1 H1 - 5,8 m<sup>3</sup>

### Vehicle equipped with:

- 1 ord. no. POS 102 ladder rack (ladder not supplied)
- 1 ord. no. PIL 102 wooden flooring
- 1 ord. no. PAN 102 polypropylene linings
- 1 ord. no. MDL 008 module
- 1 ord. no. MDL 011 module
- 1 ord. no. MDL 013 module
- 1 ord. no. MDL 037 module
- 1 ord. no. SFM 250 fixing bars
- 1 ord. no. ACS 004 first aid kit
- 1 ord. no. ACS 007 spray cans holder
- 1 ord. no. ACS 005 paper roll holder with paper roll
- 1 ord. no. ACS 003 support with belt for gas cylinders and extinguishers (extinguisher not supplied)

- > **FAST ASSEMBLY**
- > **TOTAL MODULARITY**
- > **SAFETY SOUND ABSORBING ELEMENTS BETWEEN THE VARIOUS METAL COMPONENTS**
- > **ERGONOMETRIC SHAPES**
- > **HEIGHT ADJUSTMENT IN PITCH OF 25 mm OF THE VARIOUS ELEMENTS**



# Transporter







T5 short wheelbase 3000 mm  
low roof / medium roof

L1 H1 5,8 m<sup>3</sup>

L1 H2 6,7 m<sup>3</sup>

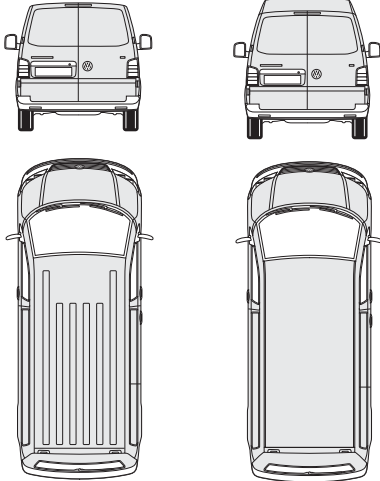

**FLOORINGS AND LININGS**

with RH side sliding door and rear leaf doors, sheet metal side walls

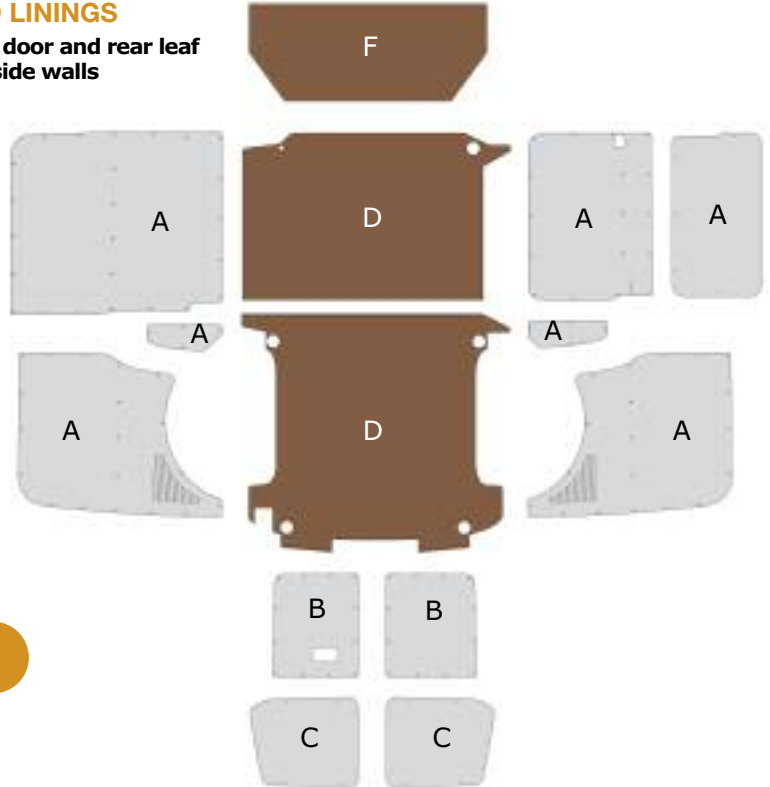

**A + B Polypropylene linings**  
Order no. PAN 102

- Weight: 10,1 Kg  
Polypropylene linings for:
- LH side wall
  - RH side wall and sliding door
  - lower section of rear leaf doors

Technical features, see page 5

**C Polypropylene linings**  
Order no. PAR 102

- Weight: 1,25 Kg  
Polypropylene linings for:
- upper section of rear leaf doors

**D Flooring**  
Order no. PIL 102  
Weight: 28,56 Kg  
12 mm thick wooden flooring phenolic coated and predrilling for lashing hook supports

**F Bulkhead**  
Order no. PIR 101  
Weight: 6,85 Kg  
12 mm wooden phenolic coated bulkhead panel

**FLOORINGS AND LININGS**

with RH side sliding door and lower lift door, sheet metal side walls

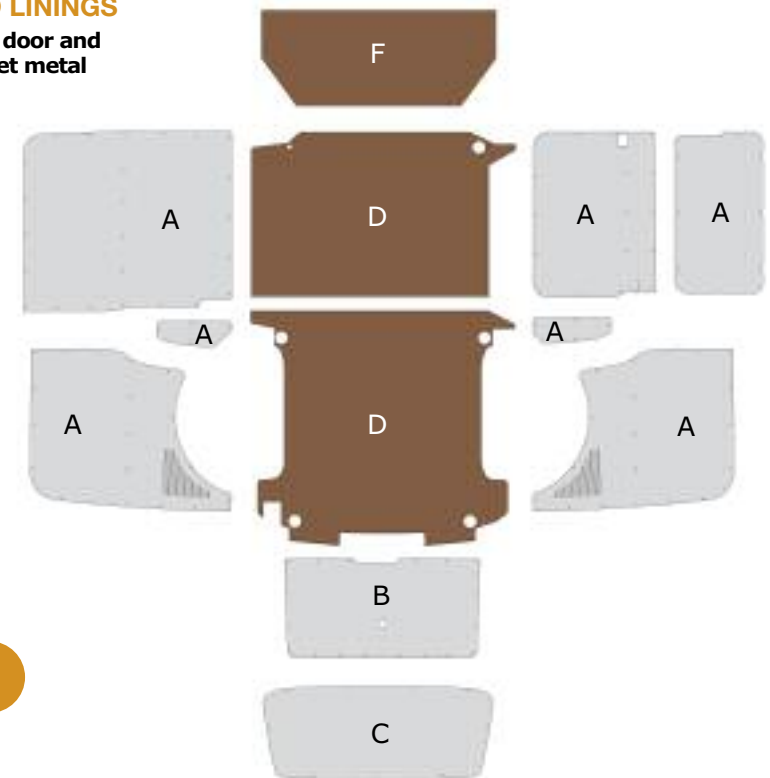
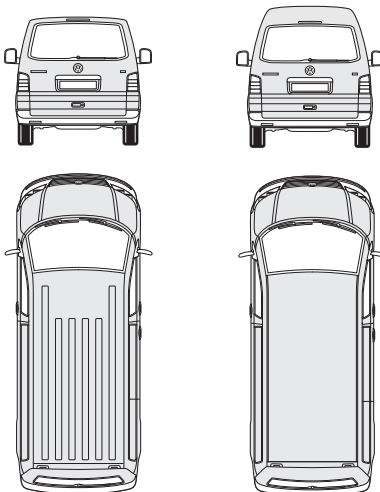

**A + B Polypropylene linings**  
Order no. PAN 103

- Weight: 10,22 Kg  
Polypropylene linings for:
- LH side wall
  - RH side wall and sliding door
  - lower part of lift door

Technical features, see page 5

**C Polypropylene linings**  
Order no. PAR 103

- Weight: 1,44 Kg  
Polypropylene linings for:
- upper part of sheet metal lift door

**D Flooring**  
Order no. PIL 102  
Weight: 28,56 Kg  
12 mm thick wooden flooring phenolic coated and predrilling for lashing hook supports

**F Cab rear panel**  
Order no. PIR 101  
Weight: 6,85 Kg  
12 mm wooden phenolic coated bulkhead panel

L1 H1 5,8 m<sup>3</sup>

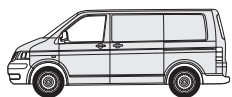

L1 H2 6,7 m<sup>3</sup>



28

T5 short wheelbase 3000 mm  
low roof / medium roof

**ROOF RACK** only for T5 low roof L1 H1 with rear leaf doors



**Order no. POT 102**

Dimensions: **2750x1600 mm** (WxD)  
Weight: **25,80 Kg**

**Roof rack** complete with:

- 4 aluminium crossmembers with fixing connectors and rubber profile
- 2 2750 mm long aluminium side upstands
- 1 aluminium loading roller

Supplied with **stainless steel** screws for fixing.

**Load capacity: 125 Kg (p.u.d.)**

**LADDER RACK** only for T5 low roof L1 H1 with rear leaf doors



The ladder rack rail can be mounted on the right or on the left hand side of the vehicle



**Order no. POS 102**

Dimensions: **2750x1580 mm** (WxD)  
Weight: **51,80 Kg**

**Ladder rack** complete with:

- 4 aluminium crossmembers with fixing connectors and rubber profile
- 1 2750 mm long aluminium side upstand
- 1 aluminium loading roller
- 1 ladder rack rail made from stainless steel and aluminium **TALENTO** series, length 2650 mm

Supplied with **stainless steel** screws for fixing.

**Load capacity: 98 Kg (p.u.d.)**

Technical features, see page 7

**READY SOLUTIONS**



MDL S01

**Order no. MDL S01**

Dimensions: **1733x365x1200 mm** (WxDxH). Weight: **43,25 Kg**

Module complete with:

- 3 trays with rubber and 15 adjustable dividers
- 1 fixing bar length 2500 mm



MDL 010

**Order no. MDL 010**

Dimensions: **1016x365x900 mm** (WxDxH). Weight: **60,1 Kg**

Module complete with:

- 1 tray with rubber and 3 adjustable dividers
- 3 drawers
- 3 retractable shelves for tool cases complete with tool cases and boxes





MODULES 717 mm



Suitable to be installed in the zone: **2**

**Order no. MDL 011**

Dimensions: **717x365x900 mm** (WxDxH)

Weight: **20 Kg**

Module complete with:

- 1 tray with rubber and 2 adjustable dividers
- 1 shelf with door
- 1 connection bar with fixing belts for tool cases

MODULES 1016 mm



Suitable to be installed in the zone: **3 5**

**Order no. MDL 008**

Dimensions: **1016x365x900 mm** (WxDxH)

Weight: **41,7 Kg**

Module complete with:

- 1 tray with rubber and 3 adjustable dividers
- 2 drawers
- 1 shelf with door
- 1 hinged door



Suitable to be installed in the zone: **3 5**

**Order no. MDL 009**

Dimensions: **1016x365x900 mm** (WxDxH)

Weight: **25,4 Kg**

Module complete with:

- 3 trays with rubber and 9 adjustable dividers

Technical features, see page 5  
Accessories see page 9



Suitable to be installed in the zone: **3 5**

**Order no. MDL 010**

Dimensions: **1016x365x900 mm** (WxDxH)

Weight: **60,1 Kg**

Module complete with:

- 1 tray with rubber and 3 adjustable dividers
- 3 drawers
- 3 retractable shelves for tool cases complete with tool cases and boxes



Suitable to be installed in the zone: **5**

**Order no. MDL 013**

Dimensions: **1016x365x900 mm** (WxDxH)

Weight: **49,7 Kg**

Module complete with:

- 3 trays with rubber and 9 adjustable partitions
- 1 retractable vice workbench complete with steel vice with 100 mm jaws and 1/2" to 1 1/2" pipe clamp

\*approximate measurement

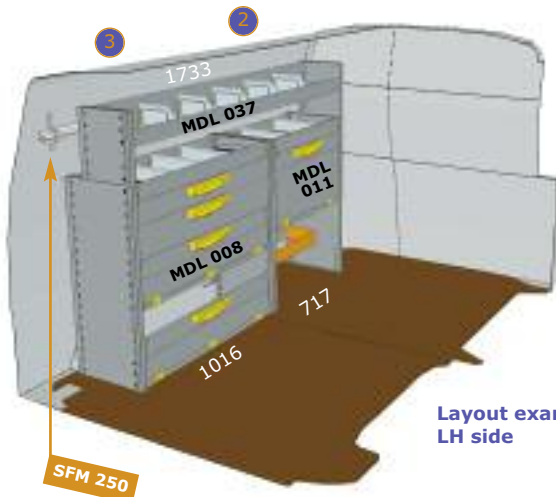
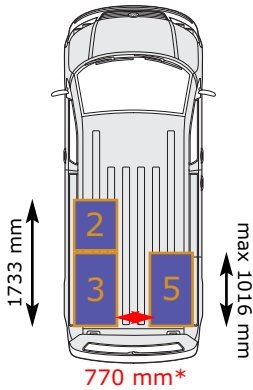

Layout example of LH side

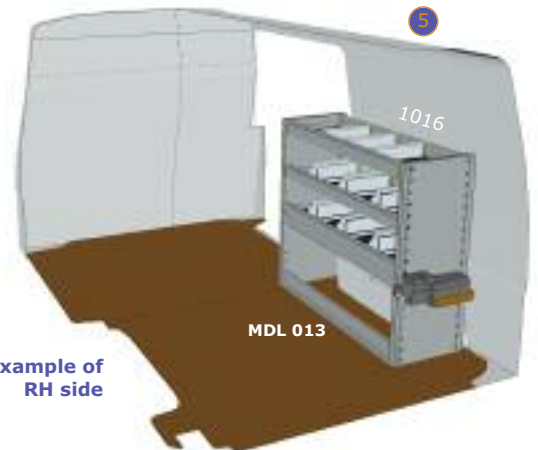

Layout example of RH side

L1 H1 5,8 m<sup>3</sup>

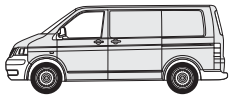

L1 H2 6,7 m<sup>3</sup>

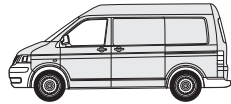

30

T5 short wheelbase 3000 mm  
low roof / medium roof

**ADD-ON MODULE 1733 mm**

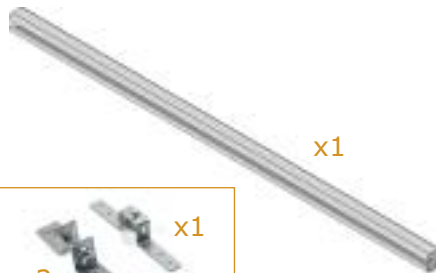

x1



x2

x1

Suitable to be installed in the zone: **2** + **3**

**Order no. MDL 037**

Dimensions: **1733x265x300 mm** (WxDxH)

Weight: **10,80 Kg**

Module complete with:

1 tray with rubber and 5 adjustable dividers

**Order no. SFM 250**

Fixing bar: **2500x30x35 mm** (WxDxH)

Weight: **2,2 Kg**

Fixing bar for upper modules, complete with brackets, bolts and screws.

**The bar is necessary to fix the additional MDL 037 module to the vehicle.**



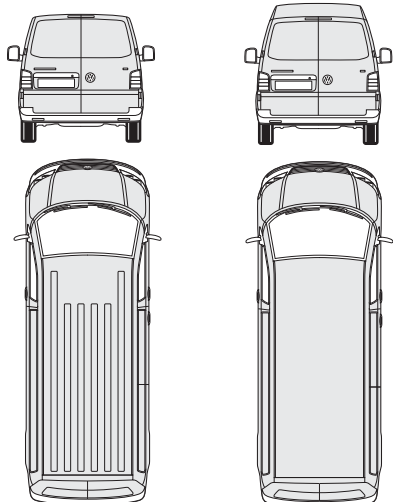
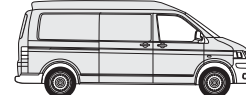
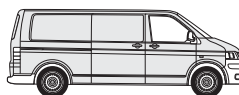

**FLOORINGS AND LININGS**

with RH side sliding door and rear leaf doors, sheet metal side walls

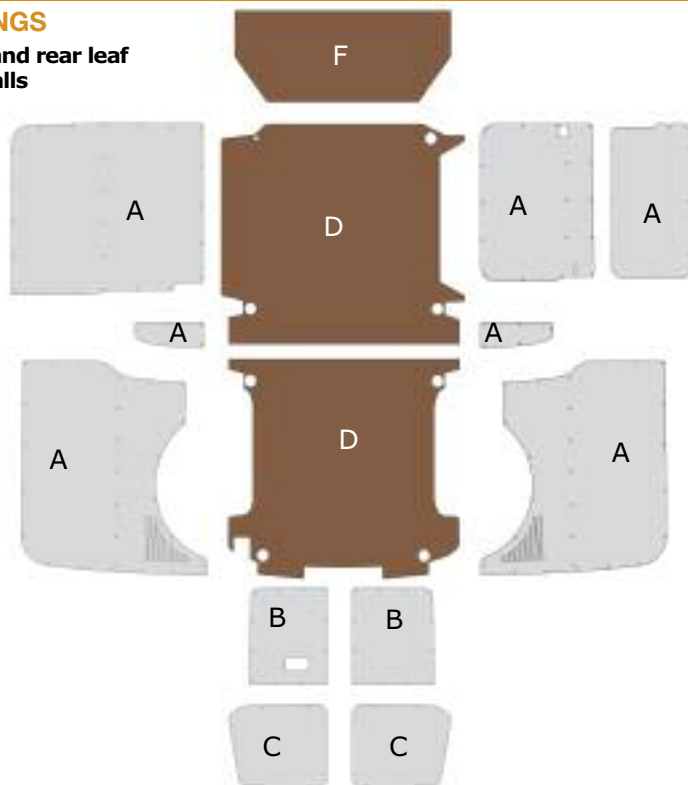

**A + B Polypropylene linings**

Order no. PAN 104

Weight: 11,69 Kg

Polypropylene linings for:

- LH side wall
- RH side wall and sliding door
- lower section of rear leaf doors

Technical features, see page 5

**C Polypropylene linings**

Order no. PAR 102

Weight: 1,25 Kg

Polypropylene linings for:

- upper section of rear leaf doors

**D Flooring**

Order no. PIL 103

Weight: 33,76 Kg

12 mm thick wooden flooring phenolic coated and predrilling for lashing hook supports.

**F Bulkhead**

Order no. PIR 101

Weight: 6,85 Kg

12 mm wooden phenolic coated bulkhead panel.

**FLOORINGS AND LININGS**

with RH side sliding door and lower lift door, sheet metal side walls

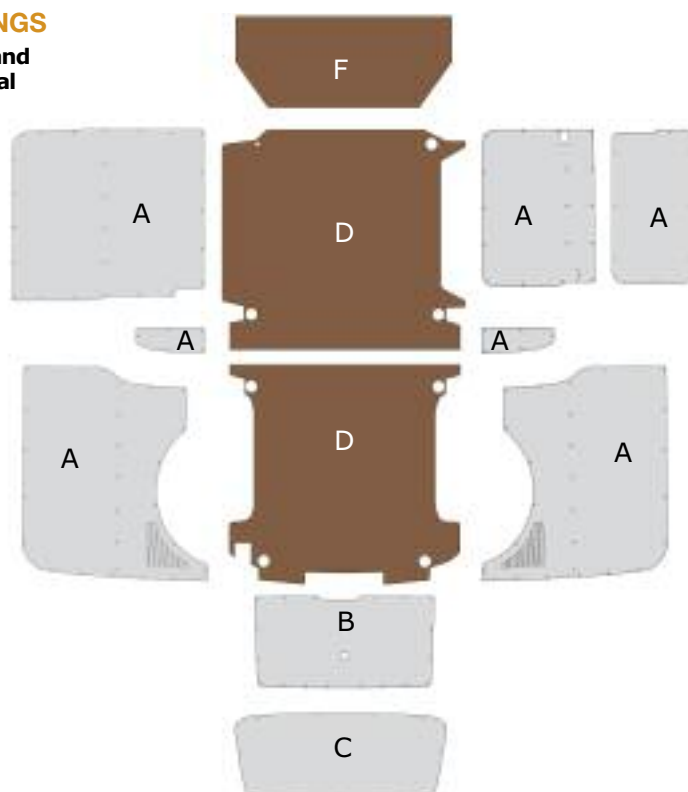
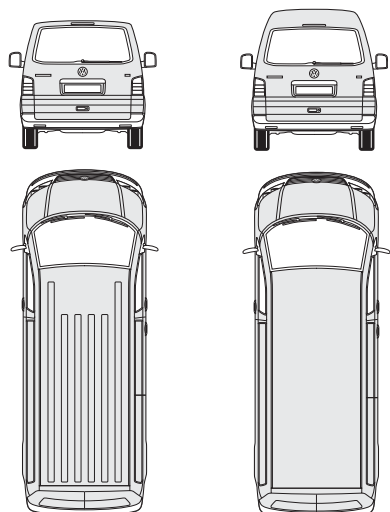

**A + B Polypropylene linings**

Order no. PAN 105

Weight: 11,81 Kg

Polypropylene linings for:

- LH side wall
- RH side wall and sliding door
- lower part of lift door

Technical features, see page 5

**C Polypropylene linings**

Order no. PAR 103

Weight: 1,44 Kg

Polypropylene linings for:

- upper part of sheet metal lift door

**D Flooring**

Order no. PIL 103

Weight: 33,76 Kg

12 mm thick wooden flooring phenolic coated and predrilling for lashing hook supports.

**F Bulkhead**

Order no. PIR 101

Weight: 6,85 Kg

12 mm wooden phenolic coated bulkhead panel.



L2 H1 6,7 m<sup>3</sup>

L2 H2 7,8 m<sup>3</sup>

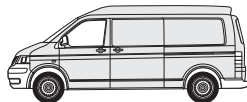
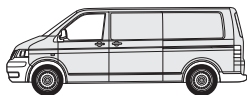

T5 long wheelbase 3400 mm  
low roof / medium roof

**ROOF RACK** only for T5 low roof L2 H1 with rear leaf doors



**Order no. POT 103**

Dimensions: **3400x1600 mm** (WxD)  
Weight: **33,60 Kg**

**Roof rack** complete with:

- 5 aluminium crossmembers with fixing connectors and rubber profile
- 2 3400 mm long aluminium side upstands
- 1 aluminium loading roller

Supplied with **stainless steel** screws for fixing.

**Load capacity: 117 Kg (p.u.d.)**

**LADDER RACK** only for T5 low roof L2 H1 with rear leaf doors



The ladder rack rail can be mounted on the right or on the left hand side of the vehicle



**Order no. POS 103**

Dimensions: **3400x1580 mm** (WxD)  
Weight: **56,90 Kg**

**Ladder rack** complete with:

- 4 aluminium crossmembers with fixing connectors and rubber profile
- 1 3400 mm long aluminium side upstand
- 1 aluminium loading roller
- 1 ladder rack rail made from stainless steel and aluminium **TALENTO** series, lenght 3240 mm

Supplied with **stainless steel** screws for fixing.

**Load capacity: 93 Kg (p.u.d.)**

Technical features, see page 7

**READY SOLUTIONS**



MDL S02

**Order no. MDL S02**

Dimensions: **2032x365x1200 mm** (WxDxH). Weight: **46,35 Kg**

Module complete with:

- 3 trays with rubber and 15 adjustable dividers
- 1 fixing bar length 3000 mm

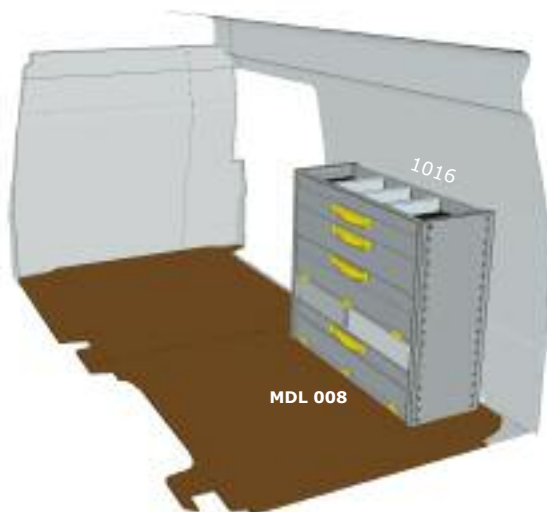

MDL 008

**Order no. MDL 008**

Dimensions: **1016x365x900 mm** (WxDxH). Weight: **41,7 Kg**

Module complete with:

- 1 tray with rubber and 3 adjustable dividers
- 2 drawers
- 1 shelf with door
- 1 hinged door

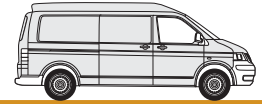
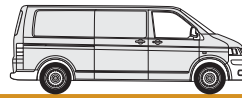

MODULES 1016 mm



Suitable to be installed in the zone: **2 3 5**

**Order no. MDL 008**

Dimensions: **1016x365x900 mm** (WxDxH)

Weight: **41,7 Kg**

Module complete with:

- 1 tray with rubber and 3 adjustable dividers
- 2 drawers
- 1 shelf with door
- 1 hinged door

Suitable to be installed in the zone: **2 3 5**

**Order no. MDL 009**

Dimensions: **1016x365x900 mm** (WxDxH)

Weight: **25,4 Kg**

Module complete with:

- 3 trays with rubber and 9 adjustable dividers

Suitable to be installed in the zone: **2 3 5**

**Order no. MDL 010**

Dimensions: **1016x365x900 mm** (WxDxH)

Weight: **60,1 Kg**

Module complete with:

- 1 tray with rubber and 3 adjustable dividers
- 3 drawers
- 3 retractable shelves for tool cases complete with tool cases and boxes



Technical features, see page 5  
Accessories see page 9

Suitable to be installed in the zone: **2**

**Order no. MDL 012**

Dimensions: **1016x365x900 mm** (WxDxH)

Weight: **25,2 Kg**

Module complete with:

- 1 tray with rubber and 3 adjustable dividers
- 1 shelf with door
- 1 connection bar with fixing belts for tool cases

Suitable to be installed in the zone: **5**

**Order no. MDL 013**

Dimensions: **1016x365x900 mm** (WxDxH)

Weight: **49,7 Kg**

Module complete with:

- 3 trays with rubber and 9 adjustable dividers
- 1 retractable vice workbench complete with steel vice with 100 mm jaws and 1/2" to 1½" pipe clamp

\*approximate measurement

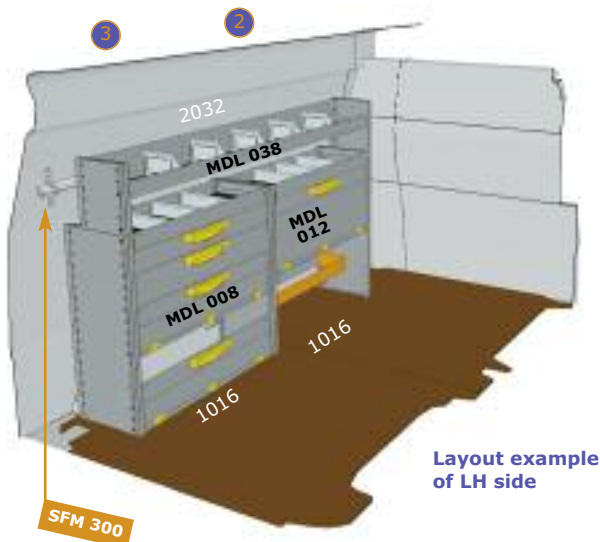
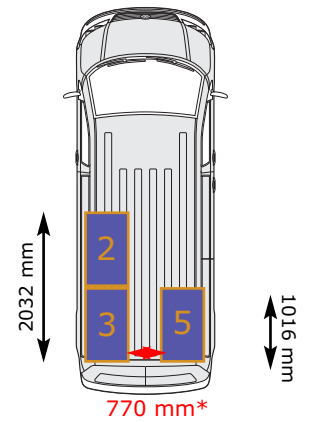

Layout example of LH side

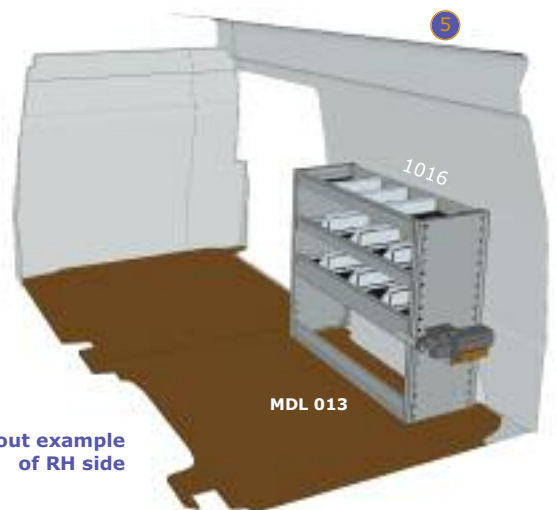

Layout example of RH side

L2 H1 6,7 m<sup>3</sup>

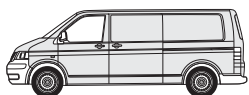

L2 H2 7,8 m<sup>3</sup>

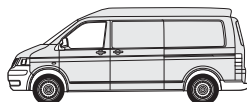

T5 long wheelbase 3400 mm  
low roof / medium roof

**ADD-ON MODULE 2032 mm**

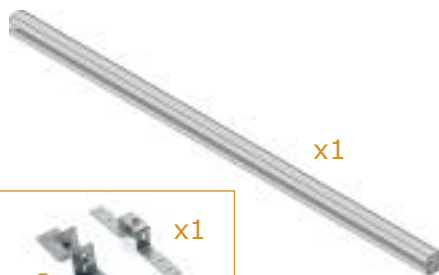

Suitable to be installed in the zone: **2** + **3**

**Order no. MDL 038**

Dimensions: **2032x265x300 mm** (WxDxH)

Weight: **11,20 Kg**

Module complete with:

1 tray with rubber and 5 adjustable dividers

**Order no. SFM 300**

Fixing bar: **3000x30x35 mm** (WxDxH)

Weight: **2,6 Kg**

Fixing bar for upper modules, complete with brackets, bolts and screws.

**The bar is necessary to fix the additional MDL 038 module to the vehicle.**





# Strategically strong



**Crafter L2 H2 - 11 m<sup>3</sup>**

- › **FAST ASSEMBLY**
- › **TOTAL MODULARITY**
- › **SAFETY SOUND ABSORBING ELEMENTS BETWEEN THE VARIOUS METAL COMPONENTS**
- › **ERGONOMIC SHAPES**
- › **HEIGHT ADJUSTMENT IN PITCH OF 25 mm OF THE VARIOUS ELEMENTS**

**Vehicle equipped with:**

- |                     |   |
|---------------------|---|
| 1 order no. POS 109 | ladder rack (ladder not supplied)   |
| 1 order no. PIL 108 | wooden floorings  |
| 1 order no. PAN 115 | polypropylene linings   |
| 1 order no. PAR 108 | polypropylene linings   |
| 1 order no. MDL 120 | module  |
| 1 order no. MDL 125 | module  |
| 1 order no. MDL 121 | module  |
| 1 order no. SFM 350 | Fixing bar  |
| 1 order no. SFM 200 | Fixing bar  |
| 1 order no. ACS 001 | hand washing kit  |
| 1 order no. ACS 004 | first aid kit   |
| 1 order no. ACS 005 | paper roll holder Ø 140 mm  |
| 1 order no. ACS 007 | spray cans holder   |
| 2 order no. ACS 003 | support with belt for gas cylinders and extinguishers (extinguisher not supplied) |



# Crafter









## FLOORINGS AND LININGS

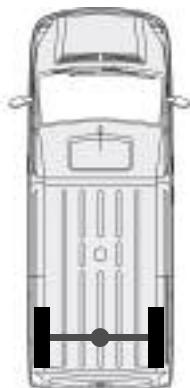

**Crafter 30 35**  
with RH side sliding door and  
rear leaf doors,  
sheet metal side walls

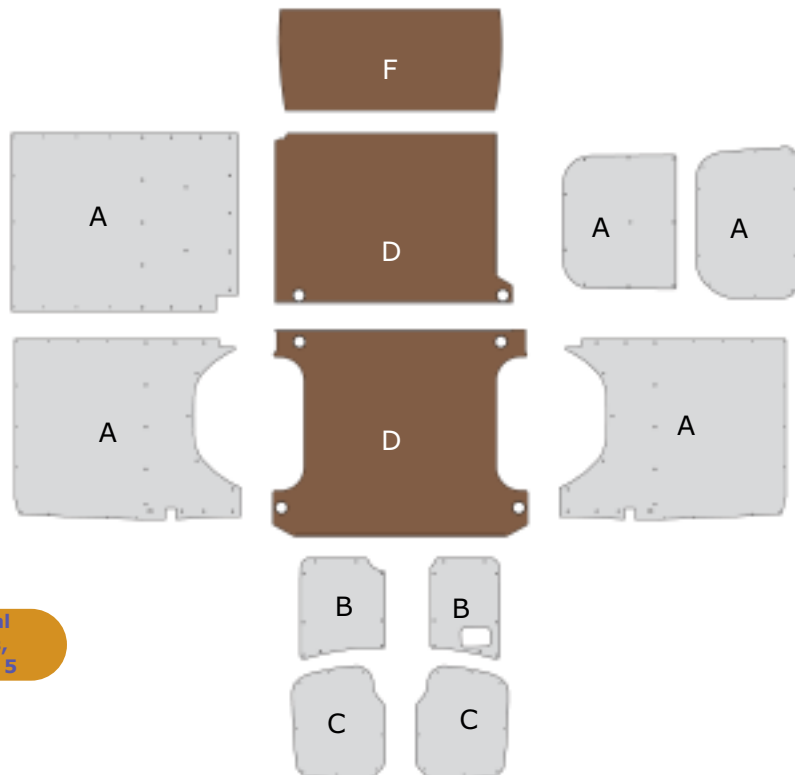

**A + B Polypropylene linings**  
Order no. PAN 113

Weight: **13,61 Kg**

**Polypropylene linings for:**

- LH side wall
- RH side wall and sliding door
- lower section of rear leaf doors

Technical  
features,  
see page 5

**C Polypropylene linings**  
Order no. PAR 107

Weight: **1,63 Kg**

**Polypropylene linings for:**

- upper section of rear leaf doors

**D Flooring**  
Order no. PIL 107

Weight: **33,26 Kg**

**12 mm thick wooden flooring phenolic coated** and predrilling for lashing hook supports.

**F Bulkhead**  
Order no. PIR 103

Weight: **8,95 Kg**

**12 mm wooden phenolic coated bulkhead panel.**

## ROOF RACK



Order no. POT 107

Dimensions: **2750x1700 mm (WxD)**

Weight: **26,70 Kg**

**Roof rack complete with:**

- 4 aluminium crossmembers with fixing connectors and rubber profile
- 2 2750 mm long aluminium side upstands
- 1 aluminium loading roller

Supplied with **stainless steel** screws for fixing.

**Load capacity: 174 Kg (p.u.d.)**

Technical  
features,  
see page 7

## LADDER RACK

The ladder rack rail can be mounted on the right or on the left hand side of the vehicle



Order no. POS 107

Dimensions: **2750x1680 mm (WxD)**

Weight: **57 Kg**

**Ladder rack complete with:**

- 4 aluminium crossmembers with fixing connectors and rubber profile
- 1 2750 mm long aluminium side upstand
- 1 aluminium loading roller
- 1 ladder rack rail made from stainless steel and aluminium **ALADIN** series, length 2650 mm

Supplied with **stainless steel** screws for fixing.

**Load capacity: 143 Kg (p.u.d.)**

7,5 m<sup>3</sup>  
L1 H1 wheelbase 3250 mm



**CRAFTER 30 35** short wheelbase  
low roof

## LOADING RAMP

### Order no. RAM 101

Dimensions: **1150x2500 mm** (WxD)  
Weight: **114,65 Kg**

Swivel loading ramp.

Load capacity: **1000 Kg** (p.u.d.)



If the loading ramp is fitted, the MDL modules for the areas **3** and **5** cannot be installed.

If you wish to install modules in areas **3** and **5**, you need to ask your nearest STORE VAN distributor for a project feasibility study.

Technical  
features,  
see page 8

## READY SOLUTIONS



### Order no. MDL 030

Dimensions: **2032x365x1200 mm** (WxDxH). Weight: **45,15 Kg**  
Module complete with:  
3 trays with rubber and 15 adjustable dividers



### Order no. MDL 014

Dimensions: **1016x365x1200 mm** (WxDxH). Weight: **49,4 Kg**  
Module complete with:  
2 trays with rubber and 6 adjustable dividers  
2 drawers  
1 shelf with door  
1 hinged door





**MODULES 1016 mm**

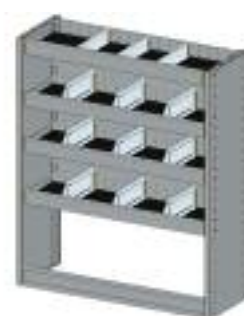
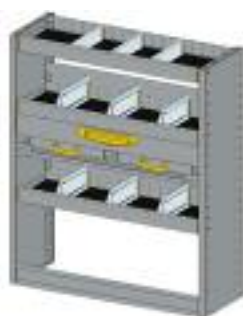

Suitable to be installed in the zone: **2 3 5**

**Order no. MDL 014**

Dimensions: **1016x365x1200 mm** (WxDxH)

Weight: **49,4 Kg**

Module complete with:

- 2 trays with rubber and 6 adjustable dividers
- 2 drawers
- 1 shelf with door
- 1 hinged door

Suitable to be installed in the zone: **2 3 5**

**Order no. MDL 015**

Dimensions: **1016x365x1200 mm** (WxDxH)

Weight: **48,3 Kg**

Module complete with:

- 3 trays with rubber and 9 adjustable dividers
- 1 drawer
- 1 retractable shelf for tool cases complete with tool cases and boxes

Suitable to be installed in the zone: **2 3 5**

**Order no. MDL 016**

Dimensions: **1016x365x1200 mm** (WxDxH)

Weight: **33,2 Kg**

Module complete with:

- 4 trays with rubber and 12 adjustable dividers

Technical features, see page 5  
Accessories see page 9

\*approximate measurement

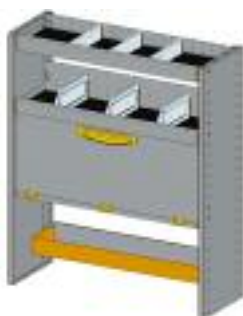
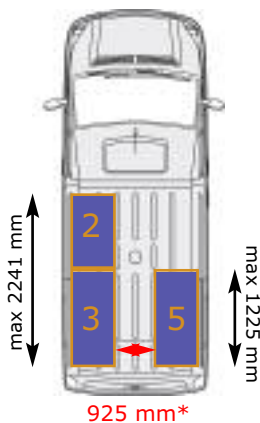

Suitable to be installed in the zone: **2**

**Order no. MDL 017**

Dimensions: **1016x365x1200 mm** (WxDxH)

Weight: **33 Kg**

Module complete with:

- 2 trays with rubber and 6 adjustable dividers
- 1 shelf with door
- 1 connection bar with fixing belts for tool cases

Suitable to be installed in the zone: **5**

**Order no. MDL 018**

Dimensions: **1016x365x1200 mm** (WxDxH)

Weight: **57,5 Kg**

Module complete with:

- 4 trays with rubber and 12 adjustable dividers
- 1 retractable vice workbench complete with steel vice with 100 mm jaws and 1/2" to 1 1/2" pipe clamp

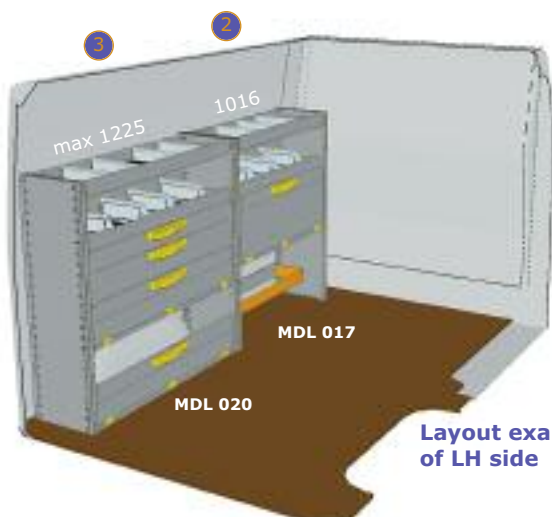

Layout example of LH side

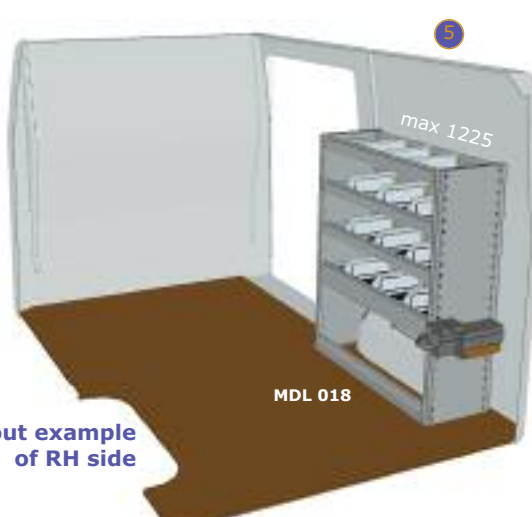

Layout example of RH side

7,5 m<sup>3</sup>  
L1 H1 wheelbase 3250 mm



CRAFTER 30 35 short wheelbase  
low roof

### MODULES 1225 mm



Suitable to be installed in the zone: **3 5**

#### Order no. MDL 020

Dimensions: **1225x365x1200 mm** (WxDxH)

Weight: **57,35 Kg**

Module complete with:

- 2 trays with rubber and 8 adjustable dividers
- 2 drawers
- 1 shelf with door
- 1 hinged door



Suitable to be installed in the zone: **3 5**

#### Order no. MDL 021

Dimensions: **1225x365x1200 mm** (WxDxH)

Weight: **55,35 Kg**

Module complete with:

- 3 trays with rubber and 12 adjustable dividers
- 1 drawer
- 1 retractable shelf for tool cases complete with tool cases and boxes



Suitable to be installed in the zone: **3 5**

#### Order no. MDL 022

Dimensions: **1225x365x1200 mm** (WxDxH)

Weight: **39,40 Kg**

Module complete with:

- 4 trays with rubber and 16 adjustable dividers





## FLOORINGS AND LININGS

**Crafter 30 35 50**

with RH side sliding door and rear leaf doors, sheet metal side walls

Technical features, see page 5

**A + B Polypropylene linings**  
**Order no. PAN 114**

Weight: **16,71 Kg**

**Polypropylene linings for:**

- LH side wall
- RH side wall and sliding door
- lower section of rear leaf doors

**C Polypropylene linings**  
**Order no. PAR 107**

Weight: **1,63 Kg**

**Polypropylene linings for:**

- upper section of rear leaf doors

**D Flooring**  
**Order no. PIL 108**

Weight: **41,92 Kg**

**12 mm thick wooden flooring phenolic coated** and predrilling for lashing hook supports.

**F Bulkhead**  
**Order no. PIR 103**

Weight: **8,95 Kg**

**12 mm wooden phenolic coated bulkhead panel.**

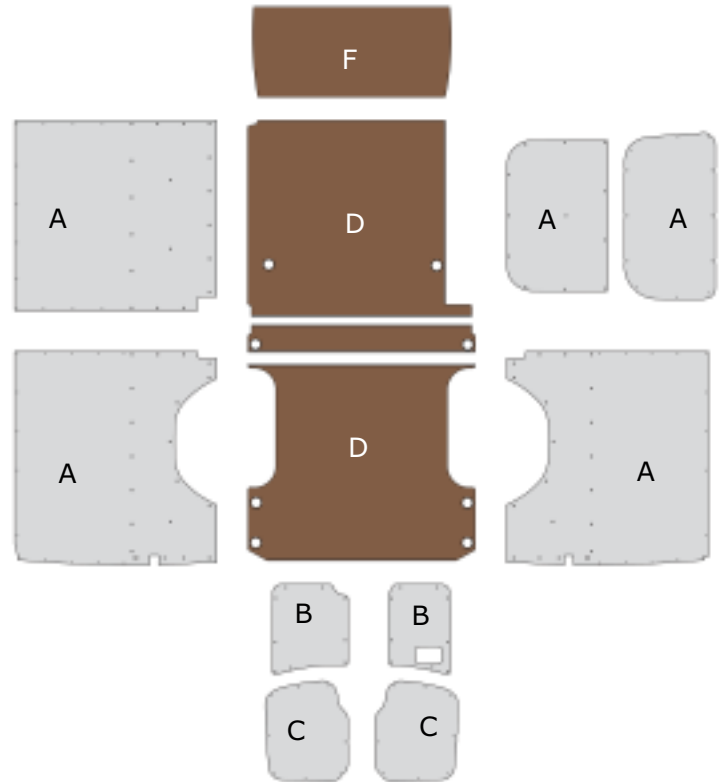

## FLOORINGS AND LININGS

**Crafter 50**

with RH lateral sliding door and hinged rear doors, sheet metal clad walls

Technical features, see page 5

**A + B Polypropylene linings**  
**Order no. PAN 114**

Weight: **16,71 Kg**

**Polypropylene linings for:**

- LH side wall
- RH side wall and sliding door
- lower section of rear leaf doors

**C Polypropylene linings**  
**Order no. PAR 107**

Weight: **1,63 Kg**

**Polypropylene linings for:**

- upper section of rear leaf doors

**D Flooring**  
**Order no. PIL 109**

Weight: **38,98 Kg**

**12 mm thick wooden flooring phenolic coated** and predrilling for lashing hook supports.

**F Bulkhead**  
**Order no. PIR 103**

Weight: **8,95 Kg**

**12 mm wooden phenolic coated bulkhead panel.**

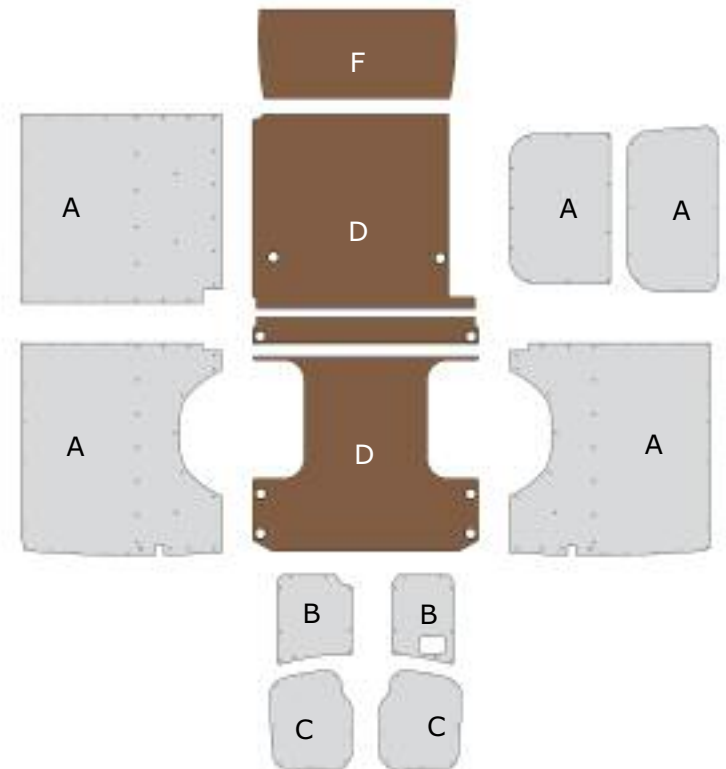



9 m<sup>3</sup>  
L2 H1 wheelbase 3665 mm



**CRAFTER 30 35 50** medium wheelbase  
low roof

## ROOF RACK



### Order no. POT 108

Dimensions: **3400x1700 mm** (WxD)  
Weight: **30,6 Kg**

**Roof rack** complete with:

- 4 aluminium crossmembers with fixing connectors and rubber profile
- 2 3400 mm long aluminium side upstands
- 1 aluminium loading roller

Supplied with **stainless steel** screws for fixing.

**Load capacity: 170 Kg (p.u.d.)**

Technical features,  
see page 7

## LADDER RACK

The ladder rack rail can be mounted on the right or on the left hand side of the vehicle



### Order no. POS 108

Dimensions: **3400x1680 mm** (WxD)  
Weight: **61,90 Kg**

**Ladder rack** complete with:

- 4 aluminium crossmembers with fixing connectors and rubber profile
- 1 3400 mm long aluminium side upstand
- 1 aluminium loading roller
- 1 ladder rack rail made from stainless steel and aluminium **ALADIN series**, length 3240 mm

Supplied with **stainless steel** screws for fixing.

**Load capacity: 138 Kg (p.u.d.)**

## LOADING RAMP

### Order no. RAM 101

Dimensions: **1150x2500 mm** (WxD)  
Weight: **114,65 Kg**

**Swivel loading ramp.**

**Load capacity: 1000 Kg (p.u.d.)**

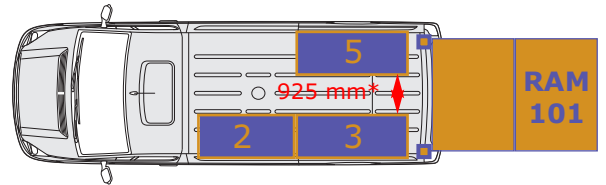

The swivel loading ramp can be installed also when the modules are fitted.

If the loading ramp is fitted, the MDL modules for the areas **3** and **5** must not be longer than 1225 mm. It is advisable to ask your nearest STORE VAN distributor for a project feasibility study.

Technical features,  
see page 8

## READY SOLUTIONS



### Order no. MDL S03

Dimensions: **2749x365x1200 mm** (WxDxH). Weight: **75,25 Kg**  
Set of 2 modules complete with:

- 7 trays with rubber and 27 adjustable dividers

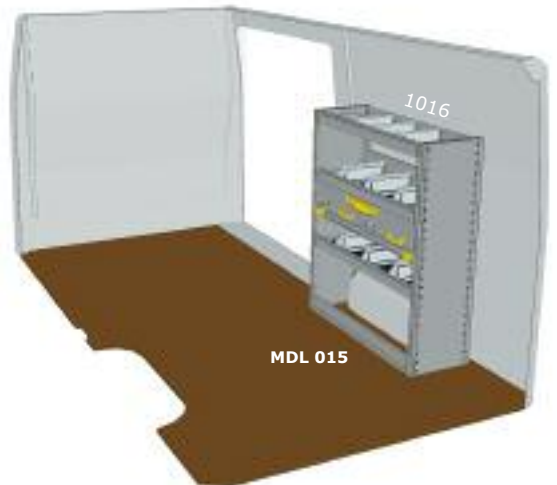

### Order no. MDL 015

Dimensions: **1016x365x1200 mm** (WxDxH). Weight: **48,3 Kg**  
Module complete with:

- 3 trays with rubber and 9 adjustable dividers
- 1 drawer
- 1 retractable shelf for tool cases complete with tool cases and boxes



MODULES 1016 mm



Suitable to be installed in the zone: **2 3 5**

**Order no. MDL 014**

Dimensions: **1016x365x1200 mm** (WxDxH)

Weight: **49,4 Kg**

Module complete with:

- 2 trays with rubber and 6 adjustable dividers
- 2 drawers
- 1 shelf with door
- 1 hinged door



Suitable to be installed in the zone: **2 3 5**

**Order no. MDL 015**

Dimensions: **1016x365x1200 mm** (WxDxH)

Weight: **48,3 Kg**

Module complete with:

- 3 trays with rubber and 9 adjustable dividers
- 1 drawer
- 1 retractable shelf for tool cases complete with tool cases and boxes

\*approximate measurement

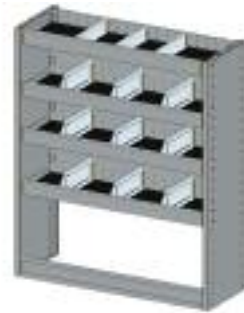
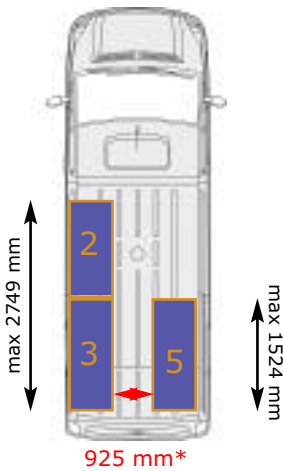

Suitable to be installed in the zone: **2 3 5**

**Order no. MDL 016**

Dimensions: **1016x365x1200 mm** (WxDxH)

Weight: **33,2 Kg**

Module complete with:

- 4 trays with rubber and 12 adjustable dividers



Suitable to be installed in the zone: **2**

**Order no. MDL 017**

Dimensions: **1016x365x1200 mm** (WxDxH)

Weight: **33 Kg**

Module complete with:

- 2 trays with rubber and 6 adjustable dividers
- 1 shelf with door
- 1 connection bar with fixing belts for tool cases

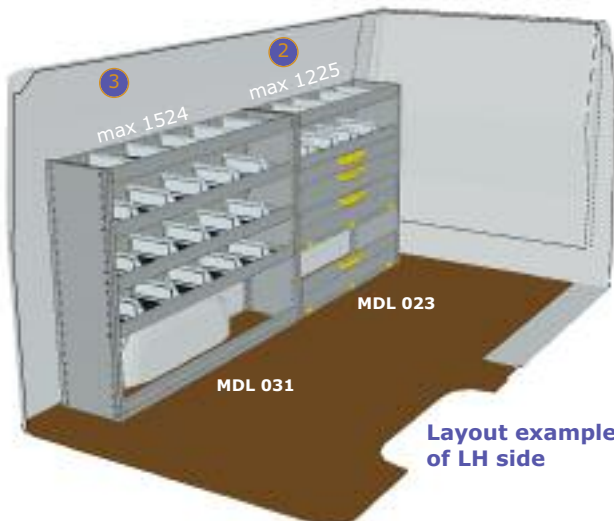

Layout example of LH side

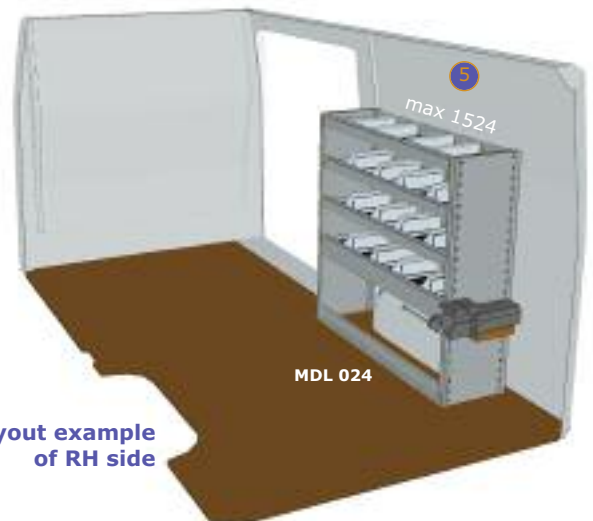

Layout example of RH side



MODULES 1225 mm

MODULES 1524 mm



Suitable to be installed in the zone: **2 3 5**

**Order no. MDL 020**

Dimensions: **1225x365x1200 mm** (WxDxH)

Weight: **57,35 Kg**

Module complete with:

- 2 trays with rubber and 8 adjustable dividers
- 2 drawers
- 1 shelf with door
- 1 hinged door

Suitable to be installed in the zone: **2 3 5**

**Order no. MDL 021**

Dimensions: **1225x365x1200 mm** (WxDxH)

Weight: **55,35 Kg**

Module complete with:

- 3 trays with rubber and 12 adjustable dividers
- 1 drawer
- 1 retractable shelf for tool cases complete with tool cases and boxes

Suitable to be installed in the zone: **3 5**

**Order no. MDL 025**

Dimensions: **1524x365x1200 mm** (WxDxH)

Weight: **47,45 Kg**

Module complete with:

- 4 trays with rubber and 20 adjustable dividers



Suitable to be installed in the zone: **2 3 5**

**Order no. MDL 022**

Dimensions: **1225x365x1200 mm** (WxDxH)

Weight: **39,40 Kg**

Module complete with:

- 4 trays with rubber and 16 adjustable dividers

Suitable to be installed in the zone: **2**

**Order no. MDL 023**

Dimensions: **1225x365x1200 mm** (WxDxH)

Weight: **39,05 Kg**

Module complete with:

- 2 trays with rubber and 8 adjustable dividers
- 1 shelf with door
- 1 connection bar with fixing belts for tool cases



Suitable to be installed in the zone: **5**

**Order no. MDL 024**

Dimensions: **1225x365x1200 mm** (WxDxH)

Weight: **66,45 Kg**

Module complete with:

- 4 trays with rubber and 16 adjustable dividers
- 1 retractable vice workbench complete with steel vice with 100 mm jaws and 1/2" to 1 1/2" pipe clamp

Technical features,  
see page 5

Accessories  
see page 9





## FLOORINGS AND LININGS

**Crafter 30 35 50**

with RH side sliding door and rear leaf doors, sheet metal side walls

Technical features, see page 5

**A + B Polypropylene linings**

Order no. PAN 115

Weight: 19,98 Kg

**Polypropylene linings for:**

- LH side wall
- RH side wall and sliding door
- lower section of rear leaf doors

**C Polypropylene linings**

Order no. PAR 108

Weight: 1,98 Kg

**Polypropylene linings for:**

- upper section of rear leaf doors

**D Flooring**

Order no. PIL 108

Weight: 41,92 Kg

**12 mm thick wooden flooring phenolic coated** and predrilling for lashing hook supports

**F Bulkhead**

Order no. PIR 103

Weight: 8,95 Kg

**12 mm wooden phenolic coated bulkhead panel.**

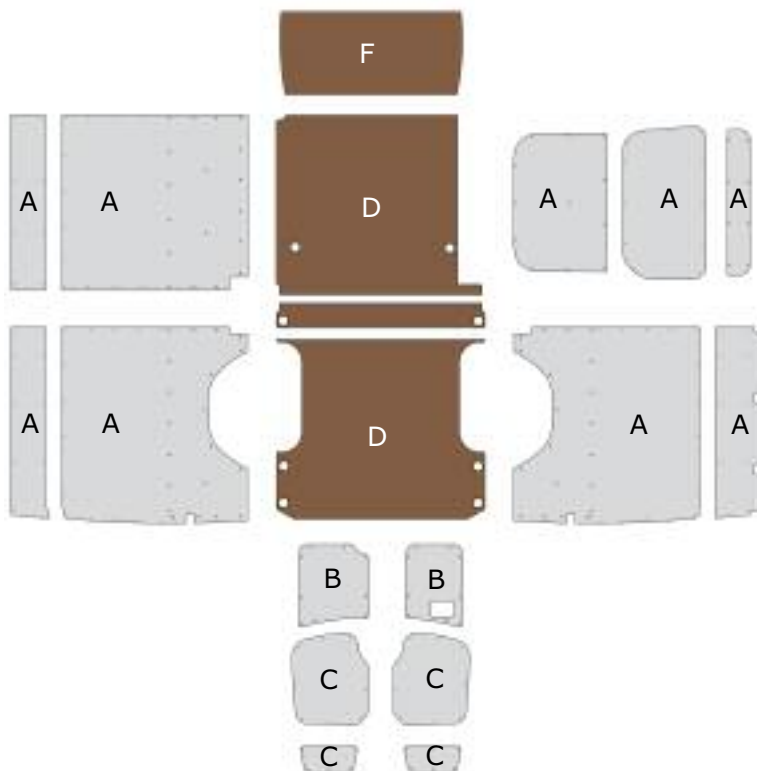

## FLOORINGS AND LININGS

**Crafter 50**

with RH side sliding door and rear leaf doors, sheet metal side walls

Technical features, see page 5

**A + B Polypropylene linings**

Order no. PAN 115

Weight: 19,98 Kg

**Polypropylene linings for:**

- LH side wall
- RH side wall and sliding door
- lower section of rear leaf doors

**C Polypropylene linings**

Order no. PAR 108

Weight: 1,98 Kg

**Polypropylene linings for:**

- upper section of rear leaf doors

**D Flooring**

Order no. PIL 109

Weight: 38,98 Kg

**12 mm thick wooden flooring phenolic coated** and predrilling for lashing hook supports.

**F Bulkhead**

Order no. PIR 103

Weight: 8,95 Kg

**12 mm wooden phenolic coated bulkhead panel.**

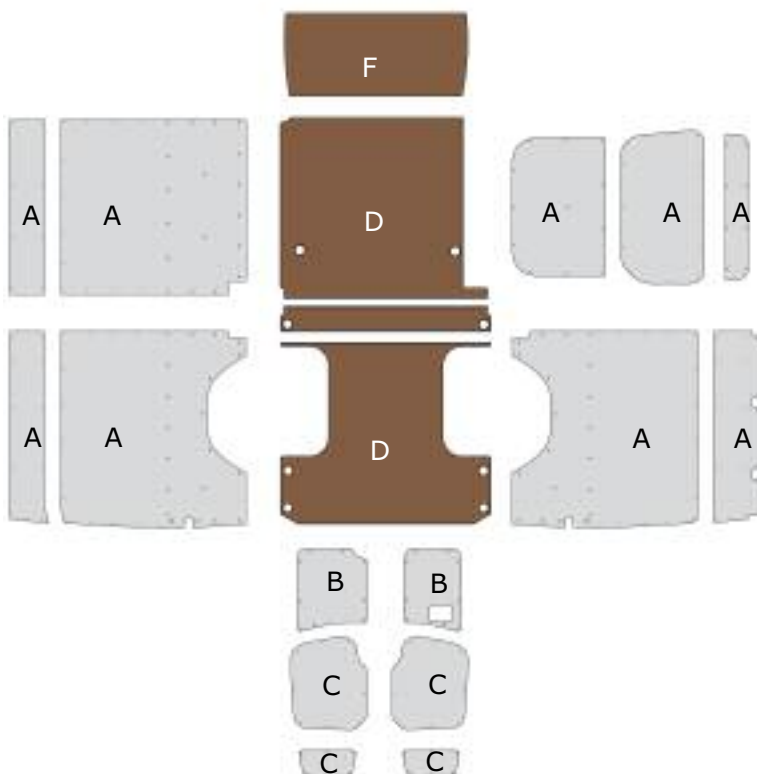

11 m<sup>3</sup>  
L2 H2 wheelbase 3665 mm



**CRAFTER 30 35 50** medium wheelbase  
high roof

## ROOF RACK



### Order no. POT 109

Dimensions: **3400x1700 mm** (WxD)  
Weight: **30,6 Kg**

#### Roof rack complete with:

- 4 aluminium crossmembers with fixing connectors and rubber profile
- 2 3400 mm long aluminium side upstands
- 1 aluminium loading roller

Supplied with **stainless steel** screws for fixing.

**Load capacity: 120 Kg (p.u.d.)**

Technical  
features,  
see page 7

## LADDER RACK

The ladder rack rail can be mounted on the right or on the left hand side of the vehicle



### Order no. POS 109

Dimensions: **3400x1680 mm** (WxD)  
Weight: **61,90 Kg**

#### Ladder rack complete with:

- 4 aluminium crossmembers with fixing connectors and rubber profile
- 1 3400 mm long aluminium side upstand
- 1 aluminium loading roller
- 1 ladder rack rail made from stainless steel and aluminium **ALADIN** series, length 3240 mm

Supplied with **stainless steel** screws for fixing.

**Load capacity: 88 Kg (p.u.d.)**

## LOADING RAMP

### Order no. RAM 102

Dimensions: **1150x3000 mm** (WxD)  
Weight: **141,65 Kg**

**Swivel loading ramp.**

**Load capacity: 1500 Kg (p.u.d.)**

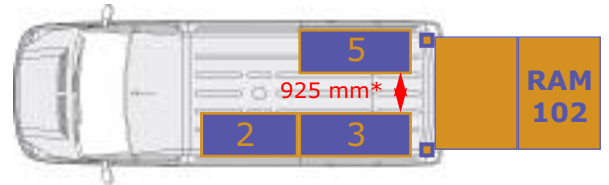

The swivel loading ramp can be installed also when the modules are fitted.  
If the loading ramp is fitted, the MDL modules for the areas **3** and **5** must not be longer than 1225 mm. It is advisable to ask your nearest STORE VAN distributor for a project feasibility study.

Technical  
features,  
see page 8

## READY SOLUTIONS



### Order no. MDL S04

Dimensions: **2749x365x1700 mm** (WxDxH)  
Weight: **103,68 Kg**

Set of 2 modules complete with:

- 10 trays with rubber and 38 adjustable dividers
- 1 fixing bar length 3500 mm



### Order no. MDL S05

Dimensions: **1016x365x1700 mm** (WxDxH). Weight: **63,68 Kg**

Module complete with:

- 5 trays with rubber and 15 adjustable dividers
- 1 drawer
- 1 retractable shelf for tool cases complete with tool cases and boxes
- 1 fixing bar length 2000 mm



**MODULES 1016 MM**



Suitable to be installed in the zone: **2 3 5**

**Order no. MDL 114**

Dimensions: **1016x365x1700 mm** (WxDxH)

Weight: **62,90 Kg**

Module complete with:

- 4 trays with rubber and 12 adjustable dividers
- 2 drawers
- 1 shelf with door
- 1 hinged door



Suitable to be installed in the zone: **2 3 5**

**Order no. MDL 115**

Dimensions: **1016x365x1700 mm** (WxDxH)

Weight: **61,80 Kg**

Module complete with:

- 5 trays with rubber and 15 adjustable dividers
- 1 drawer
- 1 retractable shelf for tool cases complete with tool cases and boxes

\*approximate measurement

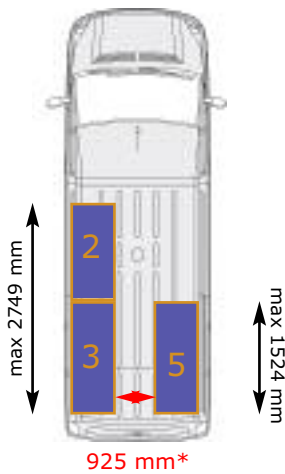

Suitable to be installed in the zone: **2 3 5**

**Order no. MDL 116**

Dimensions: **1016x365x1700 mm** (WxDxH)

Weight: **46,70 Kg**

Module complete with:

- 6 trays with rubber and 18 adjustable dividers



Suitable to be installed in the zone: **2**

**Order no. MDL 117**

Dimensions: **1016x365x1700 mm** (WxDxH)

Weight: **46,50 Kg**

Module complete with:

- 4 trays with rubber and 12 adjustable dividers
- 1 shelf with door
- 1 connection bar with fixing belts for tool cases

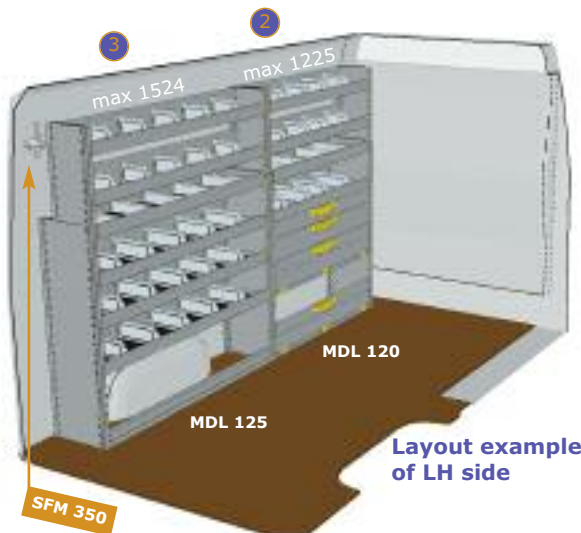

**Layout example of LH side**



**Layout example of RH side**





MODULES 1225 MM



Suitable to be installed in the zone: **2 3 5**

**Order no. MDL 120**

Dimensions: **1225x365x1700 mm** (WxDxH)  
Weight: **72,95 Kg**

Module complete with:

- 4 trays with rubber and 16 adjustable dividers
- 2 drawers
- 1 shelf with door
- 1 hinged door

Suitable to be installed in the zone: **2 3 5**

**Order no. MDL 121**

Dimensions: **1225x365x1700 mm** (WxDxH)  
Weight: **70,95 Kg**

Module complete with:

- 5 trays with rubber and 20 adjustable dividers
- 1 drawer
- 1 retractable shelf for tool cases complete with tool cases and boxes



Suitable to be installed in the zone: **2 3 5**

**Order no. MDL 122**

Dimensions: **1225x365x1700 mm** (WxDxH)  
Weight: **55,00 Kg**

Module complete with:

- 6 trays with rubber and 24 adjustable dividers

Suitable to be installed in the zone: **2**

**Order no. MDL 123**

Dimensions: **1225x365x1700 mm** (WxDxH)  
Weight: **54,65 Kg**

Module complete with:

- 4 trays with rubber and 16 adjustable dividers
- 1 shelf with door
- 1 connection bar with fixing belts for tool cases



Suitable to be installed in the zone: **5**

**Order no. MDL 124**

Dimensions: **1225x365x1700 mm** (WxDxH)  
Weight: **82,05 Kg**

Module complete with:

- 6 trays with rubber and 24 adjustable dividers
- 1 retractable vice workbench complete with steel vice with 100 mm jaws and 1/2" to 1 1/2" pipe clamp

MODULES 1524 MM



Suitable to be installed in the zone: **3 5**

**Order no. MDL 125**

Dimensions: **1524x365x1700 mm** (WxDxH)  
Weight: **65,35 Kg**

Module complete with:

- 6 trays with rubber and 30 adjustable dividers

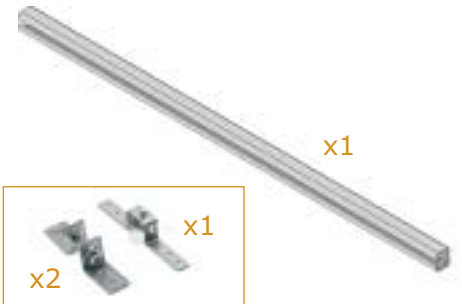

**Order no. SFM 350**

Fixing bar: **3500x30x35 mm** (WxDxH)  
Weight: **2,93 Kg**

Fixing bar for modules, complete with brackets, bolts and screws.

**The bar is necessary to fix the modules to the vehicle.**

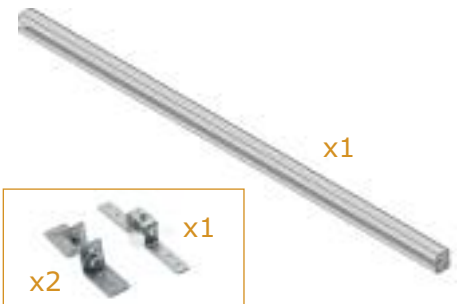

**Order no. SFM 200**

Fixing bar: **2000x30x35 mm** (WxDxH)  
Weight: **1,88 Kg**

Fixing bar for modules, complete with brackets, bolts and screws.

**The bar is necessary to fix the modules to the vehicle.**

Technical features, see page 5

Accessories see page 9

**FLOORINGS AND LININGS**

**Crafter 35 50**

with RH side sliding door and rear leaf doors, sheet metal side walls

Technical features, see page 5

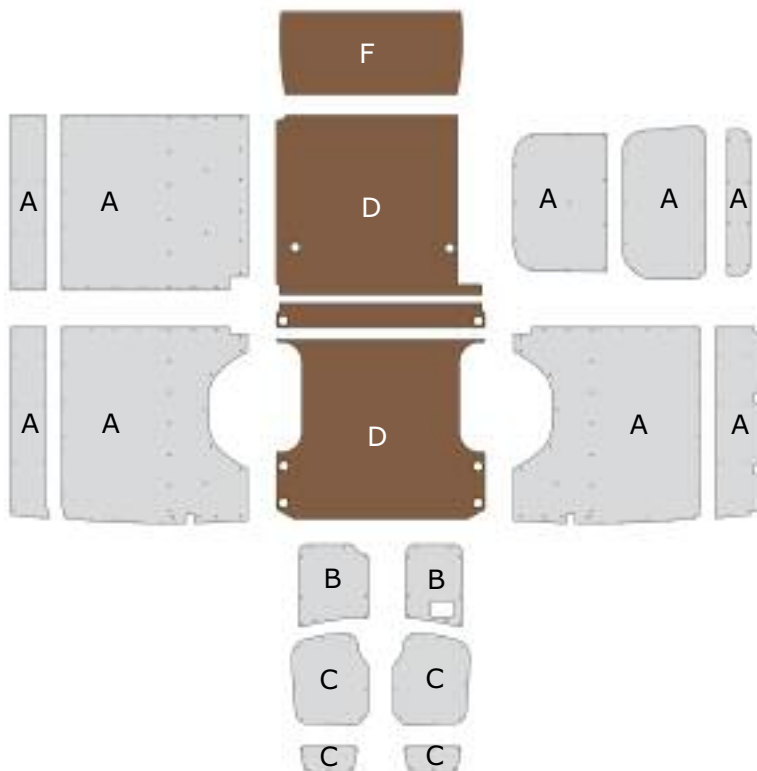
**A + B Polypropylene linings**  
**Order no. PAN 115**

 Weight: **19,98 Kg**
**Polypropylene linings for:**

- LH side wall
- RH side wall and sliding door
- lower section of rear leaf doors

**C Polypropylene linings**  
**Order no. PAR 108**

 Weight: **1,98 Kg**
**Polypropylene linings for:**

- upper section of rear leaf doors

**D Flooring**  
**Order no. PIL 108**

 Weight: **41,92 Kg**
**12 mm thick wooden flooring phenolic coated** and predrilling for lashing hook supports.

**F Bulkhead**  
**Order no. PIR 103**

 Weight: **8,95 Kg**
**12 mm wooden phenolic coated bulkhead panel.**
**FLOORINGS AND LININGS**

**Crafter 50**

with RH side sliding door and rear leaf doors, sheet metal side walls

Technical features, see page 5

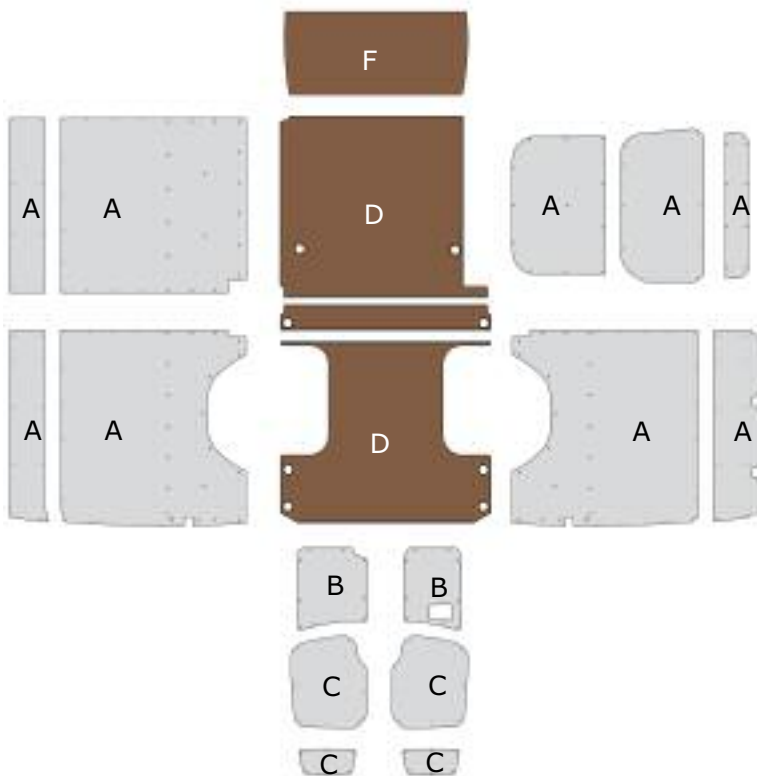
**A + B Polypropylene linings**  
**Order no. PAN 115**

 Weight: **19,98 Kg**
**Polypropylene linings for:**

- LH side wall
- RH side wall and sliding door
- lower section of rear leaf doors

**C Polypropylene linings**  
**Order no. PAR 108**

 Weight: **1,98 Kg**
**Polypropylene linings for:**

- upper section of rear leaf doors

**D Flooring**  
**Order no. PIL 109**

 Weight: **38,98 Kg**
**12 mm thick wooden flooring phenolic coated** and predrilling for lashing hook supports.

**F Bulkhead**  
**Order no. PIR 103**

 Weight: **8,95 Kg**
**12 mm wooden phenolic coated bulkhead panel.**

11,5 m<sup>3</sup>  
L2 H3 wheelbase 3665 mm



CRAFTER 35 50 medium wheelbase  
extra high roof

52

## LOADING RAMP

### Order no. RAM 102

Dimensions: **1150x3000 mm** (WxD)  
Weight: **141,65 Kg**

Swivel loading ramp.

Load capacity: **1500 Kg** (p.u.d.)



The swivel loading ramp can be installed also when the modules are fitted.  
If the loading ramp is fitted, the MDL modules for the areas **3** and **5** must not be longer than 1225 mm.  
It is advisable to ask your nearest STORE VAN distributor for a project feasibility study.

Technical features,  
see page 8

## READY SOLUTIONS



### Order no. MDL S04

Dimensions: **2749x365x1700 mm** (WxDxH)

Weight: **103,68 Kg**

Set of 2 modules complete with:

- 10 trays with rubber and 38 adjustable dividers
- 1 fixing bar length 3500 mm



### Order no. MDL S05

Dimensions: **1016x365x1700 mm** (WxDxH). Weight: **63,68 Kg**

Module complete with:

- 5 trays with rubber and 15 adjustable dividers
- 1 drawer
- 1 retractable shelf for tool cases complete with tool cases and boxes
- 1 fixing bar length 2000 mm





**MODULES 1016 mm**



Suitable to be installed in the zone: **2 3 5**

**Order no. MDL 114**

Dimensions: **1016x365x1700 mm** (WxDxH)

Weight: **62,90 Kg**

Module complete with:

- 4 trays with rubber and 12 adjustable dividers
- 2 drawers
- 1 shelf with door
- 1 hinged door



Suitable to be installed in the zone: **2 3 5**

**Order no. MDL 115**

Dimensions: **1016x365x1700 mm** (WxDxH)

Weight: **61,80 Kg**

Module complete with:

- 5 trays with rubber and 15 adjustable dividers
- 1 drawer
- 1 retractable shelf for tool cases complete with tool cases and boxes

\*approximate measurement

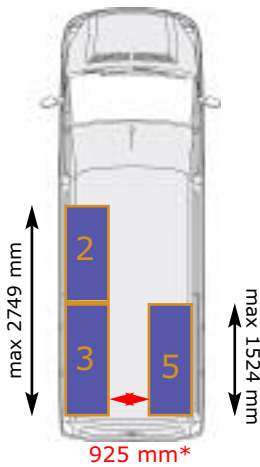

Suitable to be installed in the zone: **2 3 5**

**Order no. MDL 116**

Dimensions: **1016x365x1700 mm** (WxDxH)

Weight: **46,70 Kg**

Module complete with:

- 6 trays with rubber and 18 adjustable dividers



Suitable to be installed in the zone: **2**

**Order no. MDL 117**

Dimensions: **1016x365x1700 mm** (WxDxH)

Weight: **46,50 Kg**

Module complete with:

- 4 trays with rubber and 12 adjustable dividers
- 1 shelf with door
- 1 connection bar with fixing belts for tool cases

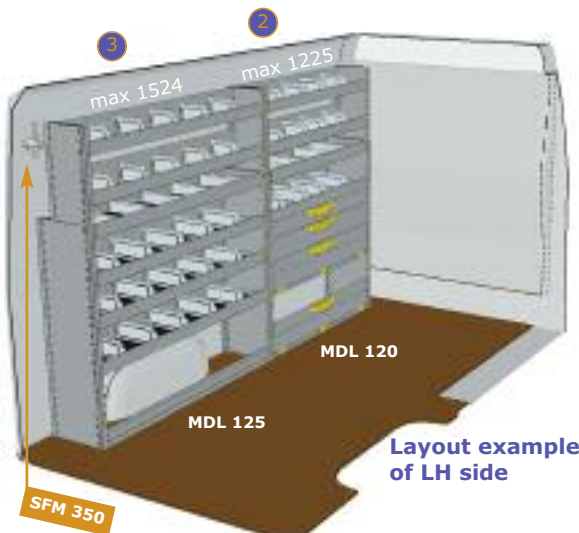

Layout example of LH side



Layout example of RH side



**MODULES 1225 mm**



Suitable to be installed in the zone: **2 3 5**

**Order no. MDL 120**

Dimensions: **1225x365x1700 mm** (WxDxH)  
Weight: **72,95 Kg**

Module complete with:

- 4 trays with rubber and 16 adjustable dividers
- 2 drawers
- 1 shelf with door
- 1 hinged door

Suitable to be installed in the zone: **2 3 5**

**Order no. MDL 121**

Dimensions: **1225x365x1700 mm** (WxDxH)  
Weight: **70,95 Kg**

Module complete with:

- 5 trays with rubber and 20 adjustable dividers
- 1 drawer
- 1 retractable shelf for tool cases complete with tool cases and boxes



Suitable to be installed in the zone: **2 3 5**

**Order no. MDL 122**

Dimensions: **1225x365x1700 mm** (WxDxH)  
Weight: **55,00 Kg**

Module complete with:

- 6 trays with rubber and 24 adjustable dividers

Suitable to be installed in the zone: **2**

**Order no. MDL 123**

Dimensions: **1225x365x1700 mm** (WxDxH)  
Weight: **54,65 Kg**

Module complete with:

- 4 trays with rubber and 16 adjustable dividers
- 1 shelf with door
- 1 connection bar with fixing belts for tool cases



Suitable to be installed in the zone: **5**

**Order no. MDL 124**

Dimensions: **1225x365x1700 mm** (WxDxH)  
Weight: **82,05 Kg**

Module complete with:

- 6 trays with rubber and 24 adjustable dividers
- 1 retractable vice workbench complete with steel vice with 100 mm jaws and 1/2" to 1 1/2" pipe clamp

**MODULES 1524 mm**



Suitable to be installed in the zone: **3 5**

**Order no. MDL 125**

Dimensions: **1524x365x1700 mm** (WxDxH)  
Weight: **65,35 Kg**

Module complete with:

- 6 trays with rubber and 30 adjustable dividers

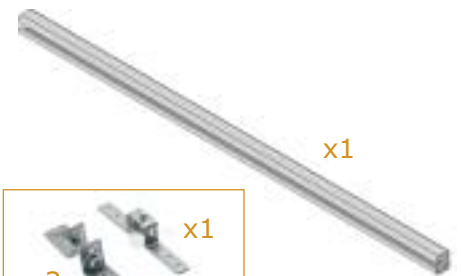

**Order no. SFM 350**

Fixing bar: **3500x30x35 mm** (WxDxH)  
Weight: **2,93 Kg**

Fixing bar for modules, complete with brackets, bolts and screws.

**The bar is necessary to fix the modules to the vehicle.**

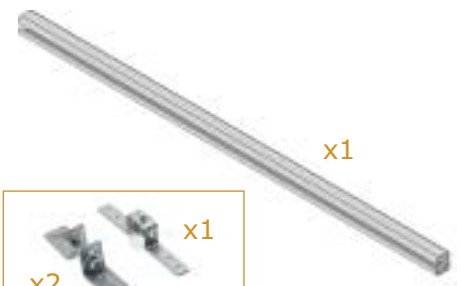

**Order no. SFM 200**

Fixing bar: **2000x30x35 mm** (WxDxH)  
Weight: **1,88 Kg**

Fixing bar for modules, complete with brackets, bolts and screws.

**The bar is necessary to fix the modules to the vehicle.**

Technical features,  
see page 5

Accessories  
see page 9

**FLOORINGS AND LININGS**

**Crafter 35 50**

with RH side sliding door and rear leaf doors, sheet metal side walls

Technical features, see page 5

**A + B Polypropylene linings**  
**Order no. PAN 116**

Weight: **28,02 Kg**

**Polypropylene linings for:**

- LH side wall
- RH side wall and sliding door
- lower section of rear leaf doors

**C Polypropylene linings**  
**Order no. PAR 108**

Weight: **1,98 Kg**

**Polypropylene linings for:**

- upper section of rear leaf doors

**D Flooring**  
**Order no. PIL 110**

Weight: **57,12 Kg**

**12 mm thick wooden flooring phenolic coated** and predrilling for lashing hook supports.

**F Bulkhead**  
**Order no. PIR 103**

Weight: **8,95 Kg**

**12 mm wooden phenolic coated bulkhead panel.**

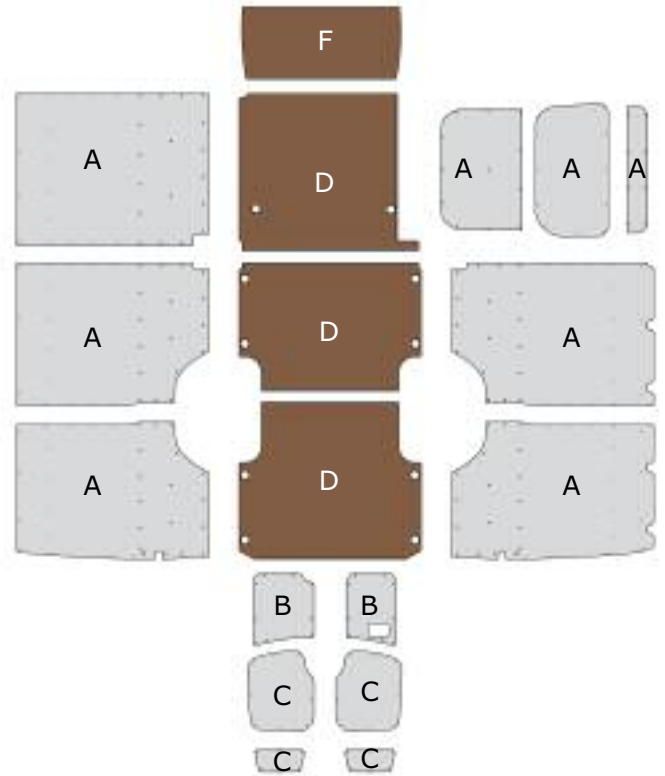
**FLOORINGS AND LININGS**

**Crafter 50**

with RH side sliding door and rear leaf doors, sheet metal side walls

Technical features, see page 5

**A + B Polypropylene linings**  
**Order no. PAN 116**

Weight: **28,02 Kg**

**Polypropylene linings for:**

- LH side wall
- RH side wall and sliding door
- lower section of rear leaf doors

**C Polypropylene linings**  
**Order no. PAR 108**

Weight: **1,98 Kg**

**Polypropylene linings for:**

- upper section of rear leaf doors

**D Flooring**  
**Order no. PIL 111**

Weight: **54,26 Kg**

**12 mm thick wooden flooring phenolic coated** and predrilling for lashing hook supports.

**F Bulkhead**  
**Order no. PIR 103**

Weight: **8,95 Kg**

**12 mm wooden phenolic coated bulkhead panel.**





14 m<sup>3</sup>  
L3 H2 wheelbase 4325 mm



**CRAFTER 35 50** long wheelbase  
high roof

## ROOF RACK



### Order no. POT 110

Dimensions: **4350x1700 mm** (WxD)  
Weight: **42,90 Kg**

#### Roof rack complete with:

- 6 aluminium crossmembers with fixing connectors and rubber profile
- 2 4350 mm long aluminium side upstands
- 1 aluminium loading roller

Supplied with **stainless steel** screws for fixing.

**Load capacity: 108 Kg (p.u.d.)**

Technical  
features,  
see page 7

## LADDER RACK

The ladder rack rail can be mounted on the right or on the left hand side of the vehicle



### Order no. POS 110

Dimensions: **4350x1680 mm** (WxD)  
Weight: **68 Kg**

#### Ladder rack complete with:

- 5 aluminium crossmembers with fixing connectors and rubber profile
- 1 4350 mm long aluminium side upstand
- 1 aluminium loading roller
- 1 ladder rack rail made from stainless steel and aluminium **ALADIN** series, length 3240 mm

Supplied with **stainless steel** screws for fixing.

**Load capacity: 82 Kg (p.u.d.)**

## LOADING RAMP

### Order no. RAM 102

Dimensions: **1150x3000 mm** (WxD)  
Weight: **141,65 Kg**

**Swivel loading ramp.**

**Load capacity: 1500 Kg (p.u.d.)**



The swivel loading ramp can be installed also when the modules are fitted.

If the loading ramp is installed the article **MDL 126 cannot be installed** in area **5**.

It is advisable to ask your nearest STORE VAN distributor for a project feasibility study.

Technical  
features,  
see page 8

## READY SOLUTIONS



MDL S06

### Order no. MDL S06

Dimensions: **3765x365x1700 mm** (WxDxH)  
Weight: **115,38 Kg**

Set of 2 modules complete with:

- 8 trays with rubber and 40 adjustable dividers
- 1 fixing bar length 4500 mm



MDL S07

### Order no. MDL S07

Dimensions: **1942x365x1700 mm** (WxDxH). Weight: **113,65 Kg**

Set of 2 modules complete with:

- 8 trays with rubber and 24 adjustable dividers, 2 shelves with doors,
- 1 connection bar with fixing belts for tool cases, 2 drawers,
- 1 hinged door, 1 fixing bar length 3000 mm



**MODULES 717 mm**



Suitable to be installed in the zone: **5a**

**Order no. MDL 119**

Dimensions: **717x365x1700 mm** (WxDxH)  
Weight: **38,10 Kg**

Module complete with:

- 4 trays with rubber and 8 adjustable dividers
- 1 shelf with door
- 1 connection bar with fixing belts for tool cases

**MODULES 1016 mm**

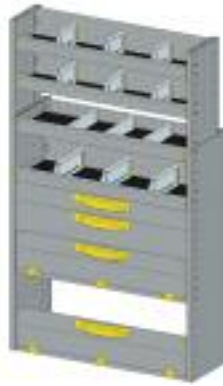

Suitable to be installed in the zone: **2 2a 3 5**

**Order no. MDL 114**

Dimensions: **1016x365x1700 mm** (WxDxH)  
Weight: **62,90 Kg**

Module complete with:

- 4 trays with rubber and 12 adjustable dividers
- 2 drawers
- 1 shelf with door
- 1 hinged door



Suitable to be installed in the zone: **2 2a 3 5**

**Order no. MDL 115**

Dimensions: **1016x365x1700 mm** (WxDxH)  
Weight: **61,80 Kg**

Module complete with:

- 5 trays with rubber and 15 adjustable dividers
- 1 drawer
- 1 retractable shelf for tool cases complete with tool cases and boxes

\*approximate measurement

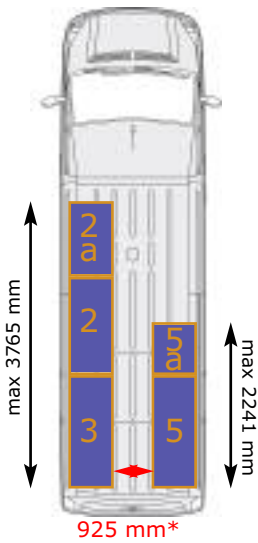

Suitable to be installed in the zone: **2 2a 3 5**

**Order no. MDL 116**

Dimensions: **1016x365x1700 mm** (WxDxH)  
Weight: **46,70 Kg**

Module complete with:

- 6 trays with rubber and 18 adjustable dividers



Suitable to be installed in the zone: **2 2a**

**Order no. MDL 117**

Dimensions: **1016x365x1700 mm** (WxDxH)  
Weight: **46,50 Kg**

Module complete with:

- 4 trays with rubber and 12 adjustable dividers
- 1 shelf with door
- 1 connection bar with fixing belts for tool cases

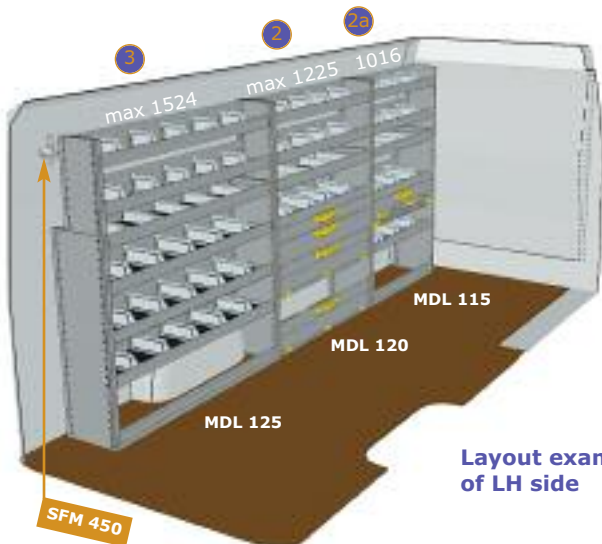

Layout example of LH side

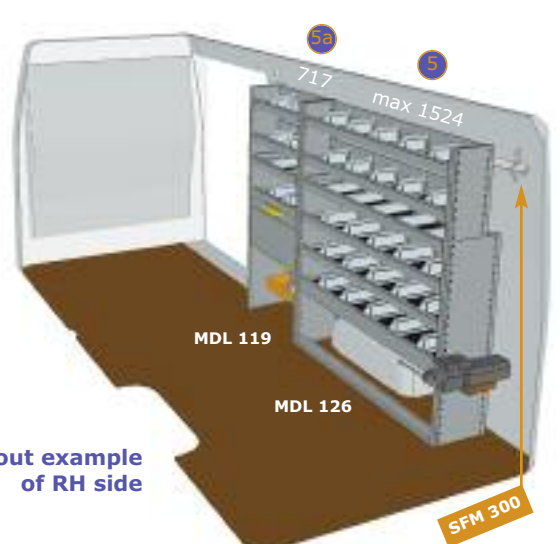

Layout example of RH side



**MODULES 1225 mm**

**MODULES 1524 mm**



Suitable to be installed in the zone: **2 3 5**

**Order no. MDL 120**

Dimensions: **1225x365x1700 mm** (WxDxH)  
Weight: **72,95 Kg**

Module complete with:

- 4 trays with rubber and 16 adjustable dividers
- 2 drawers
- 1 shelf with door
- 1 hinged door

Suitable to be installed in the zone: **2 3 5**

**Order no. MDL 121**

Dimensions: **1225x365x1700 mm** (WxDxH)  
Weight: **70,95 Kg**

Module complete with:

- 5 trays with rubber and 20 adjustable dividers
- 1 drawer
- 1 retractable shelf for tool cases complete with tool cases and boxes

Suitable to be installed in the zone: **3 5**

**Order no. MDL 125**

Dimensions: **1524x365x1700 mm** (WxDxH)  
Weight: **65,35 Kg**

Module complete with:

- 6 trays with rubber and 30 adjustable dividers



Suitable to be installed in the zone: **2 3 5**

**Order no. MDL 122**

Dimensions: **1225x365x1700 mm** (WxDxH)  
Weight: **55,00 Kg**

Module complete with:

- 6 trays with rubber and 24 adjustable dividers

Suitable to be installed in the zone: **2**

**Order no. MDL 123**

Dimensions: **1225x365x1700 mm** (WxDxH)  
Weight: **54,65 Kg**

Module complete with:

- 4 trays with rubber and 16 adjustable dividers
- 1 shelf with door
- 1 connection bar with fixing belts for tool cases

Suitable to be installed in the zone: **5**

**Order no. MDL 126**

Dimensions: **1524x365x1700 mm** (WxDxH)  
Weight: **104,80 Kg**

Module complete with:

- 6 trays with rubber and 30 adjustable dividers
- 1 retractable vice workbench complete with steel vice with 100 mm jaws and 1/2" to 1 1/2" pipe clamp

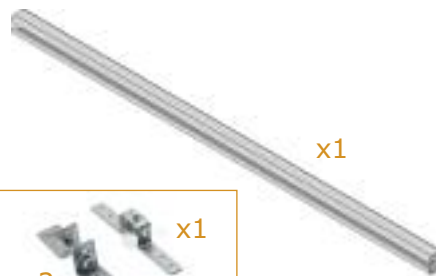
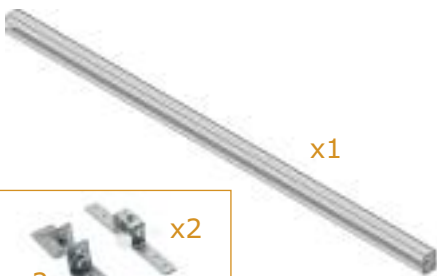

**Order no. SFM 450**

Fixing bar: **4500x30x35 mm** (WxDxH)  
Weight: **3,78 Kg**

Fixing bar for modules, complete with brackets, bolts and screws.

**The bar is necessary to fix the modules to the vehicle.**

**Order no. SFM 300**

Fixing bar: **3000x30x35 mm** (WxDxH)  
Weight: **2,60 Kg**

Fixing bar for modules, complete with brackets, bolts and screws.

**The bar is necessary to fix the modules to the vehicle.**

Technical features,  
see page 5

Accessories  
see page 9



**FLOORINGS AND LININGS**

**Crafter 35 50**

 with RH side sliding door and  
 rear leaf doors, sheet metal  
 side walls

 Technical  
 features,  
 see page 5

**A + B Polypropylene linings**
**Order no. PAN 116**

 Weight: **28,02 Kg**
**Polypropylene linings for:**

- LH side wall
- RH side wall and sliding door
- lower section of rear leaf doors

**C Polypropylene linings**
**Order no. PAR 108**

 Weight: **1,98 Kg**
**Polypropylene linings for:**

- upper section of rear leaf doors

**D Flooring**
**Order no. PIL 110**

 Weight: **57,12 Kg**
**12 mm thick wooden flooring phenolic coated** and predrilling for lashing hook supports.

**F Bulkhead**
**Order no. PIR 103**

 Weight: **8,95 Kg**
**12 mm wooden phenolic coated bulkhead panel.**

**FLOORINGS AND LININGS**

**Crafter 50**

 with RH side sliding door and  
 rear leaf doors, sheet metal  
 side walls

 Technical  
 features,  
 see page 5

**A + B Polypropylene linings**
**Order no. PAN 116**

 Weight: **28,02 Kg**
**Polypropylene linings for:**

- LH side wall
- RH side wall and sliding door
- lower section of rear leaf doors

**C Polypropylene linings**
**Order no. PAR 108**

 Weight: **1,98 Kg**
**Polypropylene linings for:**

- upper section of rear leaf doors

**D Flooring**
**Order no. PIL 111**

 Weight: **54,26 Kg**
**12 mm thick wooden flooring phenolic coated** and predrilling for lashing hook supports.

**F Bulkhead**
**Order no. PIR 103**

 Weight: **8,95 Kg**
**12 mm wooden phenolic coated bulkhead panel.**

15 m<sup>3</sup>  
L3 H3 wheelbase 4325 mm



CRAFTER 35 50 long wheelbase  
extra high roof

60

## LOADING RAMP

### Order no. RAM 102

Dimensions: **1150x3000 mm** (WxD)

Weight: **141,65 Kg**

Swivel loading ramp.

Load capacity: **1500 Kg** (p.u.d.)

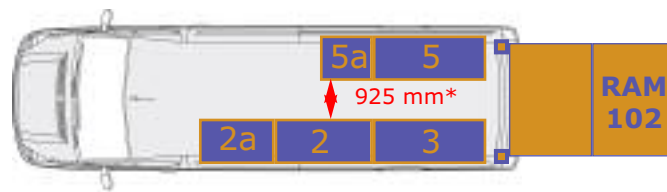

The swivel loading ramp can be installed also when the modules are fitted.

If the loading ramp is installed the article **MDL 126 cannot be installed** in area **5**.

It is advisable to ask your nearest STORE VAN distributor for a project feasibility study.

Technical features,  
see page 8

## READY SOLUTIONS



### Order no. MDL S06

Dimensions: **3765x365x1700 mm** (WxDxH)

Weight: **115,38 Kg**

Set of 2 modules complete with:

- 8 trays with rubber and 40 adjustable dividers
- 1 fixing bar length 4500 mm



### Order no. MDL S07

Dimensions: **1942x365x1700 mm** (WxDxH). Weight: **113,65 Kg**

Set of 2 modules complete with:

- 8 trays with rubber and 24 adjustable dividers, 2 shelves with doors,
- 1 connection bar with fixing belts for tool cases, 2 drawers, 1 hinged door,
- 1 fixing bar length 3000 mm



**MODULES 717 mm**



Suitable to be installed in the zone: **5a**

**Order no. MDL 119**

Dimensions: **717x365x1700 mm** (WxDxH)  
Weight: **38,10 Kg**

Module complete with:

- 4 trays with rubber and 8 adjustable dividers
- 1 shelf with door
- 1 connection bar with fixing belts for tool cases

**MODULES 1016 mm**



Suitable to be installed in the zone: **2 2a 3 5**

**Order no. MDL 114**

Dimensions: **1016x365x1700 mm** (WxDxH)  
Weight: **62,90 Kg**

Module complete with:

- 4 trays with rubber and 12 adjustable dividers
- 2 drawers
- 1 shelf with door
- 1 hinged door



Suitable to be installed in the zone: **2 2a 3 5**

**Order no. MDL 115**

Dimensions: **1016x365x1700 mm** (WxDxH)  
Weight: **61,80 Kg**

Module complete with:

- 5 trays with rubber and 15 adjustable dividers
- 1 drawer
- 1 retractable shelf for tool cases complete with tool cases and boxes

\*approximate measurement

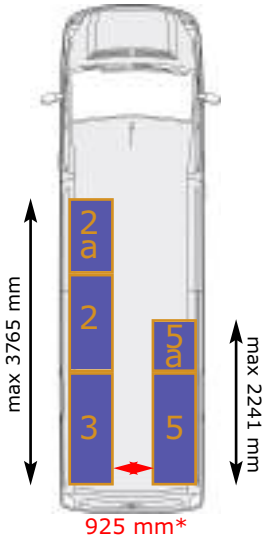

Suitable to be installed in the zone: **2 2a 3 5**

**Order no. MDL 116**

Dimensions: **1016x365x1700 mm** (WxDxH)  
Weight: **46,70 Kg**

Module complete with:

- 6 trays with rubber and 18 adjustable dividers



Suitable to be installed in the zone: **2 2a**

**Order no. MDL 117**

Dimensions: **1016x365x1700 mm** (WxDxH)  
Weight: **46,50 Kg**

Module complete with:

- 4 trays with rubber and 12 adjustable dividers
- 1 shelf with door
- 1 connection bar with fixing belts for tool cases

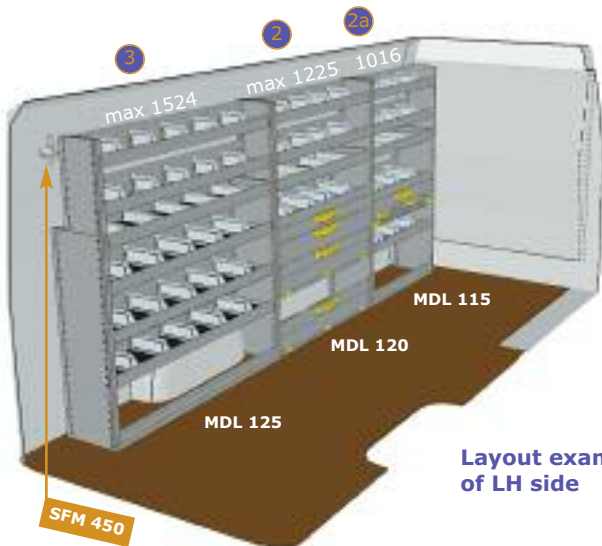

Layout example of LH side

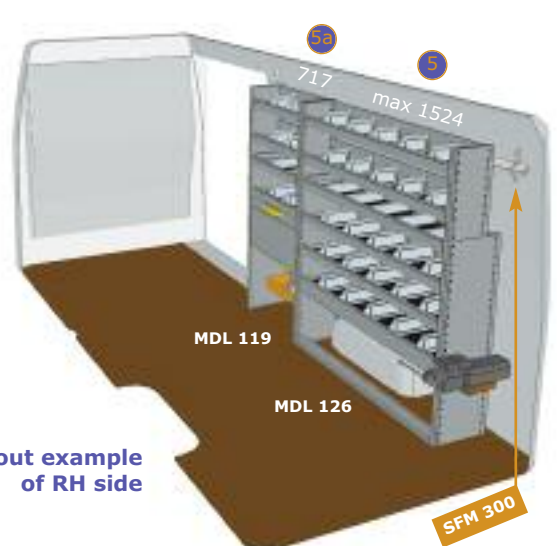

Layout example of RH side





**MODULES 1225 mm**

**MODULES 1524 mm**



Suitable to be installed in the zone: **2 3 5**

**Order no. MDL 120**

Dimensions: **1225x365x1700 mm** (WxDxH)

Weight: **72,95 Kg**

Module complete with:

- 4 trays with rubber and 16 adjustable dividers
- 2 drawers
- 1 shelf with door
- 1 hinged door

Suitable to be installed in the zone: **2 3 5**

**Order no. MDL 121**

Dimensions: **1225x365x1700 mm** (WxDxH)

Weight: **70,95 Kg**

Module complete with:

- 5 trays with rubber and 20 adjustable dividers
- 1 drawer
- 1 retractable shelf for tool cases complete with tool cases and boxes

Suitable to be installed in the zone: **3 5**

**Order no. MDL 125**

Dimensions: **1524x365x1700 mm** (WxDxH)

Weight: **65,35 Kg**

Module complete with:

- 6 trays with rubber and 30 adjustable dividers



Suitable to be installed in the zone: **2 3 5**

**Order no. MDL 122**

Dimensions: **1225x365x1700 mm** (WxDxH)

Weight: **55,00 Kg**

Module complete with:

- 6 trays with rubber and 24 adjustable dividers

Suitable to be installed in the zone: **2**

**Order no. MDL 123**

Dimensions: **1225x365x1700 mm** (WxDxH)

Weight: **54,65 Kg**

Module complete with:

- 4 trays with rubber and 16 adjustable dividers
- 1 shelf with door
- 1 connection bar with fixing belts for tool cases

Suitable to be installed in the zone: **5**

**Order no. MDL 126**

Dimensions: **1524x365x1700 mm** (WxDxH)

Weight: **104,80 Kg**

Module complete with:

- 6 trays with rubber and 30 adjustable dividers
- 1 retractable vice workbench complete with steel vice with 100 mm jaws and 1/2" to 1 1/2" pipe clamp

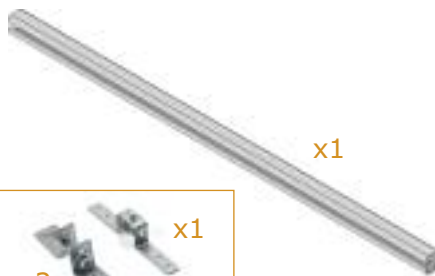
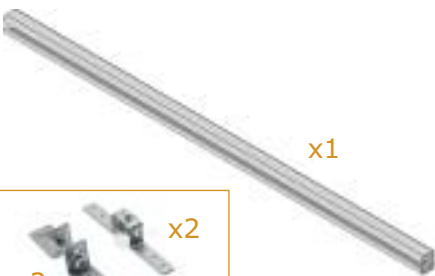

**Order no. SFM 450**

Fixing bar: **4500x30x35 mm** (WxDxH)

Weight: **3,78 Kg**

Fixing bar for modules, complete with brackets, bolts and screws.

**The bar is necessary to fix the modules to the vehicle.**

**Order no. SFM 300**

Fixing bar: **3000x30x35 mm** (WxDxH)

Weight: **2,60 Kg**

Fixing bar for modules, complete with brackets, bolts and screws.

**The bar is necessary to fix the modules to the vehicle.**

Technical features,  
see page 5

Accessories  
see page 9

**CRAFTER 35 50**

long wheelbase extended rear overhang  
high roof



15,5 m<sup>3</sup>  
L3L H2 wheelbase 4325 mm

**FLOORINGS AND LININGS****Crafter 35 50**

with RH side sliding door and rear leaf doors, sheet metal side walls

Technical features, see page 5

**A + B Polypropylene linings**

Order no. PAN 117

Weight: 30,89 Kg

**Polypropylene linings for:**

- LH side wall
- RH side wall and sliding door
- lower section of rear leaf doors

**C Polypropylene linings**

Order no. PAR 108

Weight: 1,98 Kg

**Polypropylene linings for:**

- upper section of rear leaf doors

**D Flooring**

Order no. PIL 112

Weight: 62,92 Kg

**12 mm thick wooden flooring phenolic coated** and predrilling for lashing hook supports.

**F Bulkhead**

Order no. PIR 103

Weight: 8,95 Kg

**12 mm wooden phenolic coated bulkhead panel.**

**FLOORINGS AND LININGS****Crafter 50**

with RH side sliding door and rear leaf doors, sheet metal side walls

Technical features, see page 5

**A + B Polypropylene linings**

Order no. PAN 117

Weight: 30,89 Kg

**Polypropylene linings for:**

- LH side wall
- RH side wall and sliding door
- lower section of rear leaf doors

**C Polypropylene linings**

Order no. PAR 108

Weight: 1,98 Kg

**Polypropylene linings for:**

- upper section of rear leaf doors

**D Flooring**

Order no. PIL 113

Weight: 60,14 Kg

**12 mm thick wooden flooring phenolic coated** and predrilling for lashing hook supports.

**F Bulkhead**

Order no. PIR 103

Weight: 8,95 Kg

**12 mm wooden phenolic coated bulkhead panel.**



15,5 m<sup>3</sup>  
L3L H2 wheelbase 4325 mm



long wheelbase extended rear overhang  
high roof

## ROOF RACK



### Order no. POT 111

Dimensions: **4700x1700 mm** (WxD)  
Weight: **44 Kg**

**Roof rack** complete with:

- 6 aluminium crossmembers with fixing connectors and rubber profile
- 2 4700 mm long aluminium side upstands
- 1 aluminium loading roller

Supplied with **stainless steel** screws for fixing.

**Load capacity: 107 Kg (p.u.d.)**

Technical features,  
see page 7

## LADDER RACK

The ladder rack rail can be mounted on the right or on the left hand side of the vehicle



### Order no. POS 111

Dimensions: **4700x1680 mm** (WxD)  
Weight: **72,70 Kg**

**Ladder rack** complete with:

- 6 aluminium crossmembers with fixing connectors and rubber profile
- 1 4700 mm long aluminium side upstand
- 1 aluminium loading roller
- 1 ladder rack rail made from stainless steel and aluminium **ALADIN** series, length 3240 mm

Supplied with **stainless steel** screws for fixing.

**Load capacity: 77 Kg (p.u.d.)**

## LOADING RAMP

### Order no. RAM 102

Dimensions: **1150x3000 mm** (WxD)  
Weight: **141,65 Kg**

**Swivel loading ramp.**

**Load capacity: 1500 Kg (p.u.d.)**

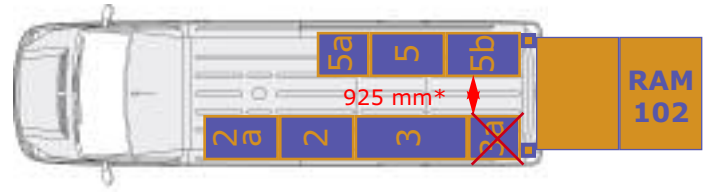

The swivel loading ramp can be installed also when the modules are fitted.

If the loading ramp is fitted, the MDL modules for the areas **5b** must not be longer than 717 mm.

MDL series modules for the area **3a** cannot be installed.

It is advisable to ask your nearest STORE VAN distributor for a project feasibility study.

Technical features,  
see page 8

## READY SOLUTIONS



### Order no. MDL S08

Dimensions: **4064x365x1700 mm** (WxDxH)  
Weight: **119,39 Kg**

Set of 2 modules complete with:

- 8 trays with rubber and 40 adjustable dividers
- 1 fixing bar length 5000 mm



### Order no. MDL S09

Dimensions: **2749x365x1700 mm** (WxDxH). Weight: **165,73 Kg**

Set of 3 modules complete with:

- 13 trays with rubber and 35 adjustable dividers, 2 shelves with doors,
- 1 connection bar with fixing belts for tool cases, 2 drawers,
- 1 hinged door, 1 retractable shelf for tool cases complete with tool cases and boxes, 1 fixing bar length 3500 mm





MODULES 717 mm



Suitable to be installed in the zone: **3a 5a 5b**

Order no. MDL 119

Dimensions: **717x365x1700 mm** (WxDxH)

Weight: **38,10 Kg**

Module complete with:

- 4 trays with rubber and 8 adjustable dividers
- 1 shelf with door
- 1 connection bar with fixing belts for tool cases

\*approximate measurement

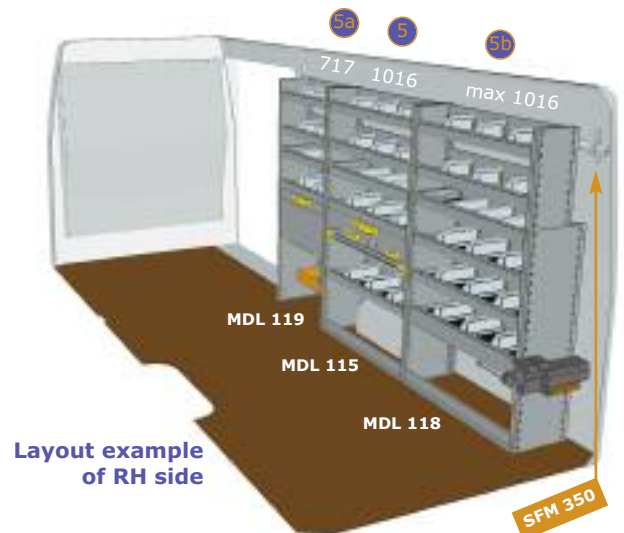
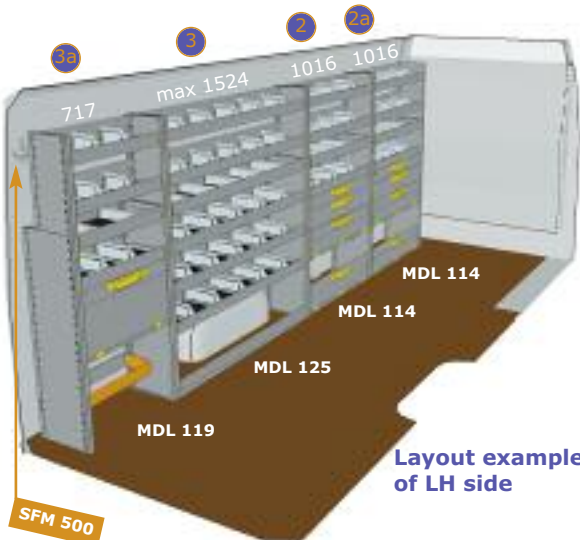
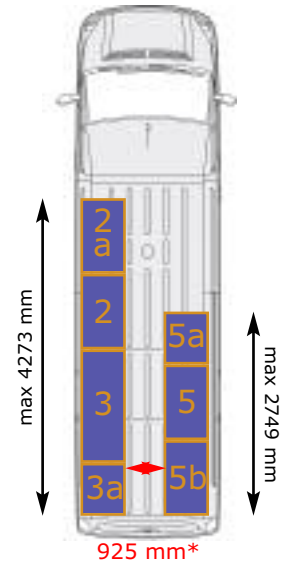



MODULES 1016 mm

MODULES 1524 mm



Suitable to be installed in the zone: **2 2a 3 5 5b**

**Order no. MDL 114**

Dimensions: **1016x365x1700 mm** (WxDxH)

Weight: **62,90 Kg**

Module complete with:

- 4 trays with rubber and 12 adjustable dividers
- 2 drawers
- 1 shelf with door
- 1 hinged door

Suitable to be installed in the zone: **2 2a 3 5 5b**

**Order no. MDL 115**

Dimensions: **1016x365x1700 mm** (WxDxH)

Weight: **61,80 Kg**

Module complete with:

- 5 trays with rubber and 15 adjustable dividers
- 1 drawer
- 1 retractable shelf for tool cases complete with tool cases and boxes

Suitable to be installed in the zone: **3**

**Order no. MDL 125**

Dimensions: **1524x365x1700 mm** (WxDxH)

Weight: **65,35 Kg**

Module complete with:

- 6 trays with rubber and 30 adjustable dividers



Suitable to be installed in the zone: **2 2a 3 5 5b**

**Order no. MDL 116**

Dimensions: **1016x365x1700 mm** (WxDxH)

Weight: **46,70 Kg**

Module complete with:

- 6 trays with rubber and 18 adjustable dividers

Suitable to be installed in the zone: **2 2a 5b**

**Order no. MDL 117**

Dimensions: **1016x365x1700 mm** (WxDxH)

Weight: **46,50 Kg**

Module complete with:

- 4 trays with rubber and 12 adjustable dividers
- 1 shelf with door
- 1 connection bar with fixing belts for tool cases

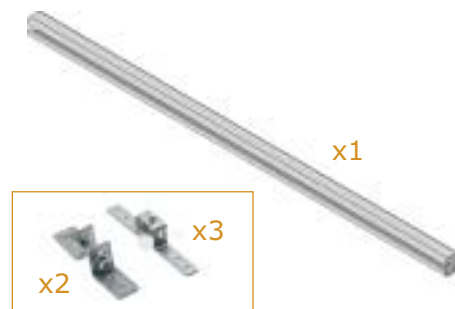

**Order no. SFM 500**

Fixing bar: **5000x30x35 mm** (WxDxH)

Weight: **4,29 Kg**

Fixing bar for modules, complete with brackets, bolts and screws.

**The bar is necessary to fix the modules to the vehicle.**

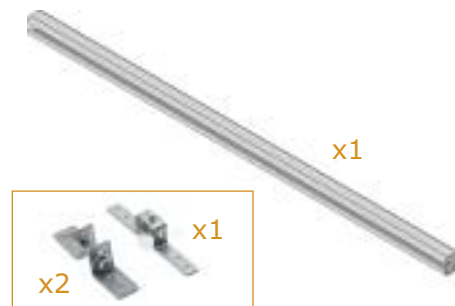

**Order no. SFM 350**

Fixing bar: **3500x30x35 mm** (WxDxH)

Weight: **2,93 Kg**

Fixing bar for modules, complete with brackets, bolts and screws.

**The bar is necessary to fix the modules to the vehicle.**



Suitable to be installed in the zone: **5b**

**Order no. MDL 118**

Dimensions: **1016x365x1700 mm** (WxDxH)

Weight: **71,00 Kg**

Module complete with:

- 6 trays with rubber and 18 adjustable dividers
- 1 retractable vice workbench complete with steel vice with 100 mm jaws and 1/2" to 1 1/2" pipe clamp

Technical features,  
see page 5

Accessories  
see page 9

**CRAFTER 35 50**

long wheelbase extended rear overhang  
extra high roof



17 m<sup>3</sup>  
L3L H3 wheelbase 4325 mm

**FLOORINGS AND LININGS****Crafter 35 50**

with RH side sliding door and  
rear leaf doors,  
sheet metal side walls

Technical  
features,  
see page 5

**A + B Polypropylene linings**

Order no. **PAN 117**

Weight: **30,89 Kg**

**Polypropylene linings for:**

- LH side wall
- RH side wall and sliding door
- lower section of rear leaf doors

**C Polypropylene linings**

Order no. **PAR 108**

Weight: **1,98 Kg**

**Polypropylene linings for:**

- upper section of rear leaf doors

**D Flooring**

Order no. **PIL 112**

Weight: **62,92 Kg**

**12 mm thick wooden flooring phenolic coated** and predrilling for lashing hook supports.

**F Bulkhead**

Order no. **PIR 103**

Weight: **8,95 Kg**

**12 mm wooden phenolic coated bulkhead panel.**

**FLOORINGS AND LININGS****Crafter 50**

with RH side sliding door and  
rear leaf doors,  
sheet metal side walls

Technical  
features,  
see page 5

**A + B Polypropylene linings**

Order no. **PAN 117**

Weight: **30,89 Kg**

**Polypropylene linings for:**

- LH side wall
- RH side wall and sliding door
- lower section of rear leaf doors

**C Polypropylene linings**

Order no. **PAR 108**

Weight: **1,98 Kg**

**Polypropylene linings for:**

- upper section of rear leaf doors

**D Flooring**

Order no. **PIL 113**

Weight: **60,14 Kg**

**12 mm thick wooden flooring phenolic coated** and predrilling for lashing hook supports.

**F Bulkhead**

Order no. **PIR 103**

Weight: **8,95 Kg**

**12 mm wooden phenolic coated bulkhead panel.**





17 m<sup>3</sup>  
L3L H3 wheelbase 4325 mm



## LOADING RAMP

### Order no. RAM 102

Dimensions: **1150x3000 mm** (WxD)  
Weight: **141,65 Kg**

Swivel loading ramp.

Load capacity: **1500 Kg** (p.u.d.)

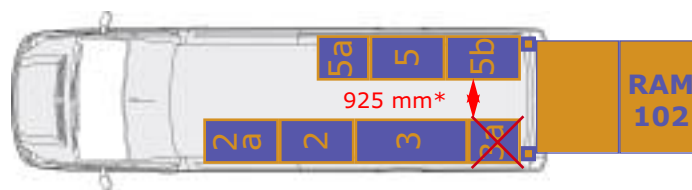

The swivel loading ramp can be installed also when the modules are fitted.

If the loading ramp is fitted, the MDL modules for the area **5b** must not be longer than 717 mm.

MDL series modules for the area **3a** cannot be installed.

It is advisable to ask your nearest STORE VAN distributor for a project feasibility study.

Technical  
features,  
see page 8

## READY SOLUTIONS



MDL S08

### Order no. MDL S08

Dimensions: **4064x365x1700 mm** (WxDxH)  
Weight: **119,39 Kg**

Set of 2 modules complete with:

- 8 trays with rubber and 40 adjustable dividers
- 1 fixing bar length 5000 mm



MDL S09

### Order no. MDL S09

Dimensions: **2749x365x1700 mm** (WxDxH). Weight: **165,73 Kg**

Set of 3 modules complete with:

- 13 trays with rubber and 35 adjustable dividers, 2 shelves with doors,
- 1 connection bar with fixing belts for tool cases, 2 drawers, 1 hinged door,
- 1 retractable shelf for tool cases complete with tool cases and boxes,
- 1 fixing bar length 3500 mm

**CRAFTER 35 50**

long wheelbase extended rear overhang  
extra high roof



17 m<sup>3</sup>  
L3L H3 wheelbase 4325 mm

**MODULES 717 mm**



Suitable to be installed in the zone: **3a 5a 5b**

**Order no. MDL 119**

Dimensions: **717x365x1700 mm** (WxDxH)

Weight: **38,10 Kg**

Module complete with:

- 4 trays with rubber and 8 adjustable dividers
- 1 shelf with door
- 1 connection bar with fixing belts for tool cases

\*approximate measurement

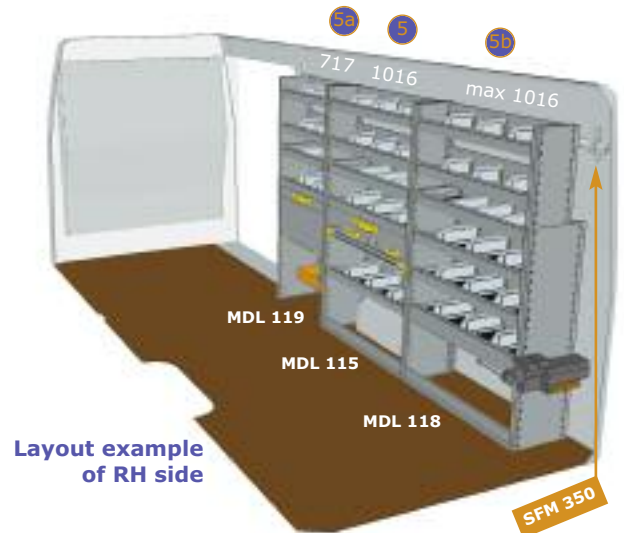
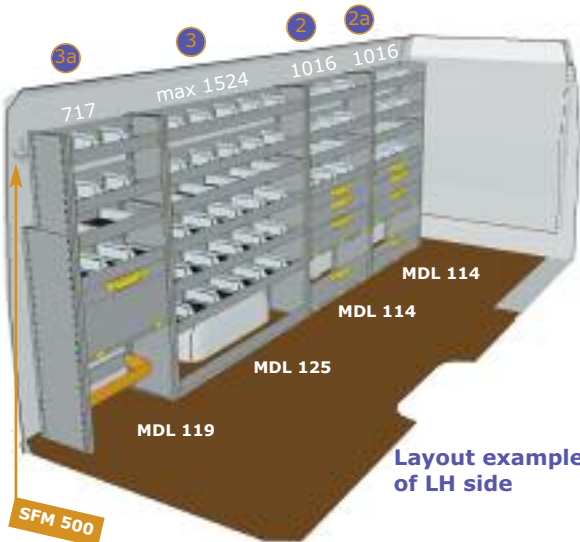
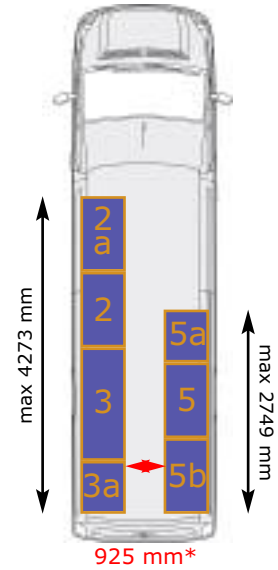

17 m<sup>3</sup>  
L3L H3 wheelbase 4325 mm



70

**CRAFTER 35 50**  
long wheelbase extended rear overhang  
**extra high roof**

### MODULES 1016 mm



Suitable to be installed in the zone: **2 2a 3 5 5b**

#### Order no. MDL 114

Dimensions: **1016x365x1700 mm** (WxDxH)

Weight: **62,90 Kg**

Module complete with:

- 4 trays with rubber and 12 adjustable dividers
- 2 drawers
- 1 shelf with door
- 1 hinged door

Suitable to be installed in the zone: **2 2a 3 5 5b**

#### Order no. MDL 115

Dimensions: **1016x365x1700 mm** (WxDxH)

Weight: **61,80 Kg**

Module complete with:

- 5 trays with rubber and 15 adjustable dividers
- 1 drawer
- 1 retractable shelf for tool cases complete with tool cases and boxes



Suitable to be installed in the zone: **2 2a 3 5 5b**

#### Order no. MDL 116

Dimensions: **1016x365x1700 mm** (WxDxH)

Weight: **46,70 Kg**

Module complete with:

- 6 trays with rubber and 18 adjustable dividers

Suitable to be installed in the zone: **2 2a 5b**

#### Order no. MDL 117

Dimensions: **1016x365x1700 mm** (WxDxH)

Weight: **46,50 Kg**

Module complete with:

- 4 trays with rubber and 12 adjustable dividers
- 1 shelf with door
- 1 connection bar with fixing belts for tool cases



Suitable to be installed in the zone: **5b**

#### Order no. MDL 118

Dimensions: **1016x365x1700 mm** (WxDxH)

Weight: **71,00 Kg**

Module complete with:

- 6 trays with rubber and 18 adjustable dividers
- 1 retractable vice workbench complete with steel vice with 100 mm jaws and 1/2" to 1 1/2" pipe clamp

### MODULES 1524 mm



Suitable to be installed in the zone: **3**

#### Order no. MDL 125

Dimensions: **1524x365x1700 mm** (WxDxH)

Weight: **65,35 Kg**

Module complete with:

- 6 trays with rubber and 30 adjustable dividers

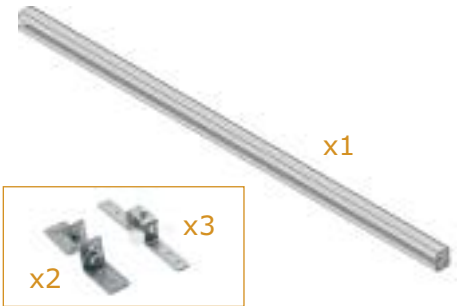

#### Order no. SFM 500

Fixing bar: **5000x30x35 mm** (WxDxH)

Weight: **4,29 Kg**

Fixing bar for modules, complete with brackets, bolts and screws.

**The bar is necessary to fix the modules to the vehicle.**

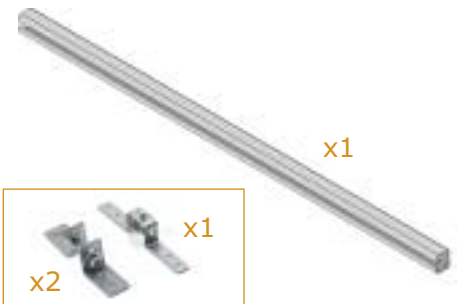

#### Order no. SFM 350

Fixing bar: **3500x30x35 mm** (WxDxH)

Weight: **2,93 Kg**

Fixing bar for modules, complete with brackets, bolts and screws.

**The bar is necessary to fix the modules to the vehicle.**

Technical features,  
see page 5

Accessories  
see page 9





**FAMI S.r.l.**  
 Via Stazione Rossano 13  
 36027 Rosà, Vicenza ITALY  
 Tel. +39 0424 585455  
 fax +39 0424 585482  
 www.storevan.com  
 info@storevan.com

YOUR STOREVAN PARTNER



**PROFESSIONALITY  
 IN MOVEMENT**