

Catalogue no. C CT gb 261 00

■ GENERAL CATALOGUE 2008

LET'S REORGANIZE YOUR SPACE

The way of living non-industrial spaces, from offices to houses, to communal facilities has radically changed. Nowadays, fittings and accessories which are not developed specifically for domestic environments are devised with a completely different and innovative application philosophy in mind.

Spaces have changed. This means some FAMI products, which are by nature compact and modular, have become ideal elements for a more organised approach to living space.

www.famispa.com

FAMI GROUP

■ ITALY

FAMI S.p.A.

Via Stazione Rossano 13 I 36027 Rosà, Vicenza I ITALY
phone +39/0424-585455 I fax +39/0424-585470
www.famispa.com I commerciale@famispa.com

Export Department

phone +39/0424-585455 I fax +39/0424-585472
export@famispa.com

■ AUSTRIA

FAMI HANDELS GmbH

Triester Straße, 136 I 1230 Wien I AUSTRIA
phone +43/1-6629889 I fax +43/1-662988915
www.fami.at I office@fami.at

■ GERMANY

**FAMI DEUTSCHLAND
LAGER SYSTEME GmbH**

Riedweg, 14 I 89340 Leipheim I GERMANY
phone +49/8221-27870 I fax +49/8221-278727
www.fami.de I info@fami.de

■ SWITZERLAND

**FAMI AG
BETRIEBS- UND LAGEREINRICHTUNGEN**

Industrie Süd 8573 Siegershausen I SWITZERLAND
phone +41/71-6991914 I fax +41/71-6991912
info@fami-ag.ch I www.fami-ag.ch

BRANCHES = ■ DISTRIBUTORS = ■

■ ITALY

MIAL S.r.L.

Via Cap. Alessio, 109
36027 Rosà, Vicenza I ITALY
phone +39/0424-583800
fax +39/0424-583838
www.mialsrl.com
info@mialsrl.com

■ POLAND

FAMI POLAND Sp z o.o.

Biuro: Ul. Wielkopolska, 3/e 26-600 RADOM I POLAND
phone +48/48-3845850
fax +48/48-3845851
www.fami.com.pl
famipoland@fami.com.pl

■ CHINA

**FAMI NORSON STORAGE EQUIPMENTS
(Shangai) Co. Ltd.**

8123 Huqingping Road - Xicen - Qingpu
201721 Shanghai
P.R. CHINA
phone +86/21-59291558/60
fax +86/21-59291562
www.faminorson.com.cn
info@faminorson.com.cn

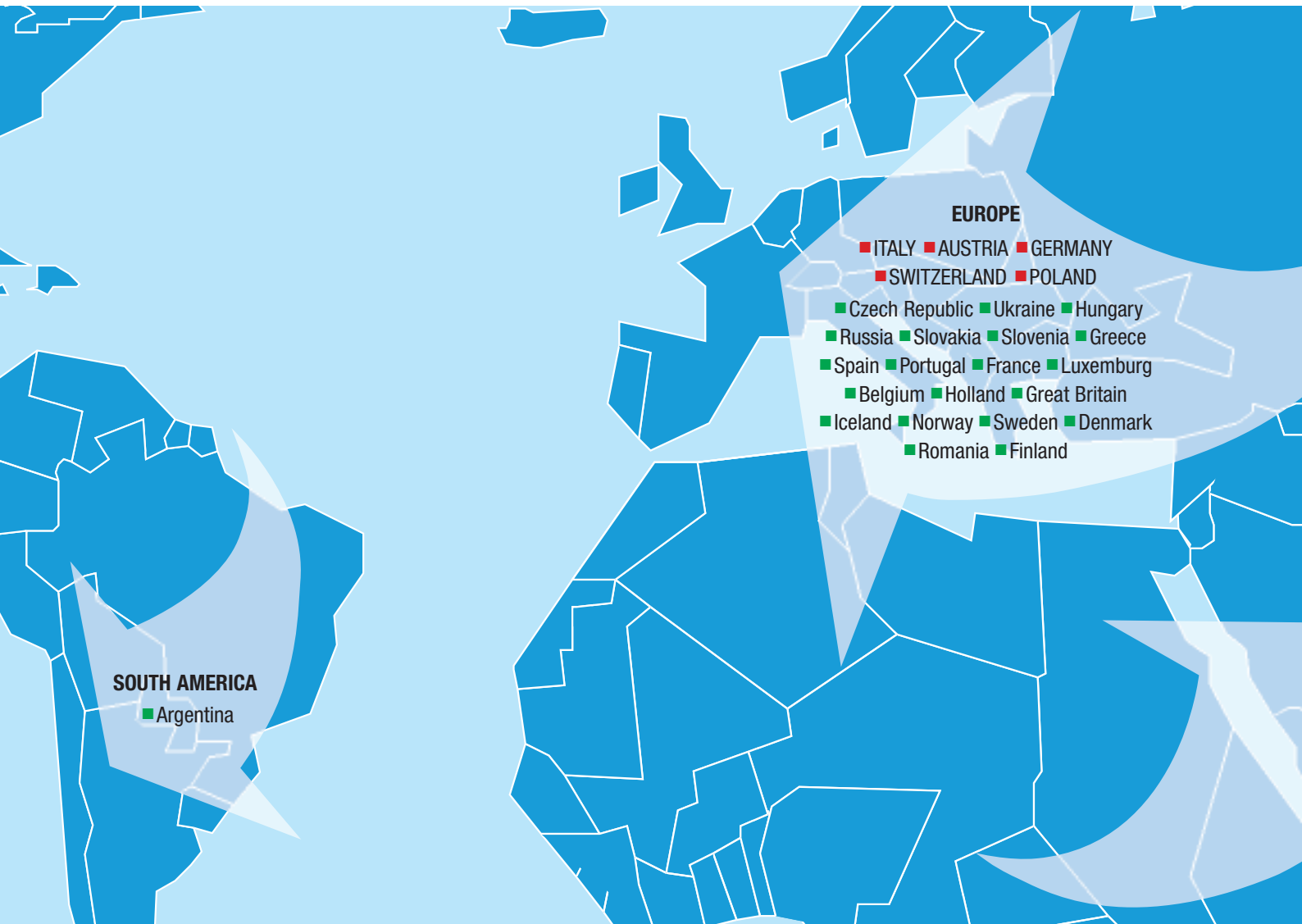

FAMI, CREATED TO CREATE

When **FAMI** was originally set up, the company was specialised in the manufacture of industrial fittings. Over the years, major financial and energy investments have been made to enhance the firm's professionalism, to build up an intensive network of relationships, and to transform the materials research into increasingly functional, innovative, and quality products. **FAMI** is now a consolidated business, with a manufacturing divisions of over 200 thousand square metres, 80 thousand of which are covered, in which 250 people work. It has five overseas branches, located in Germany, Poland, Switzerland, Austria, and China, and authorised distributors covering all of Europe, south-east Asia, the Middle East, and Latin America. Every year, 8 million kg of iron and steel are utilised, as well as 2.5 million kg of plastics. Manufacturing is carried out on an entirely in-house basis, with a division set aside solely for plastics production and moulding.

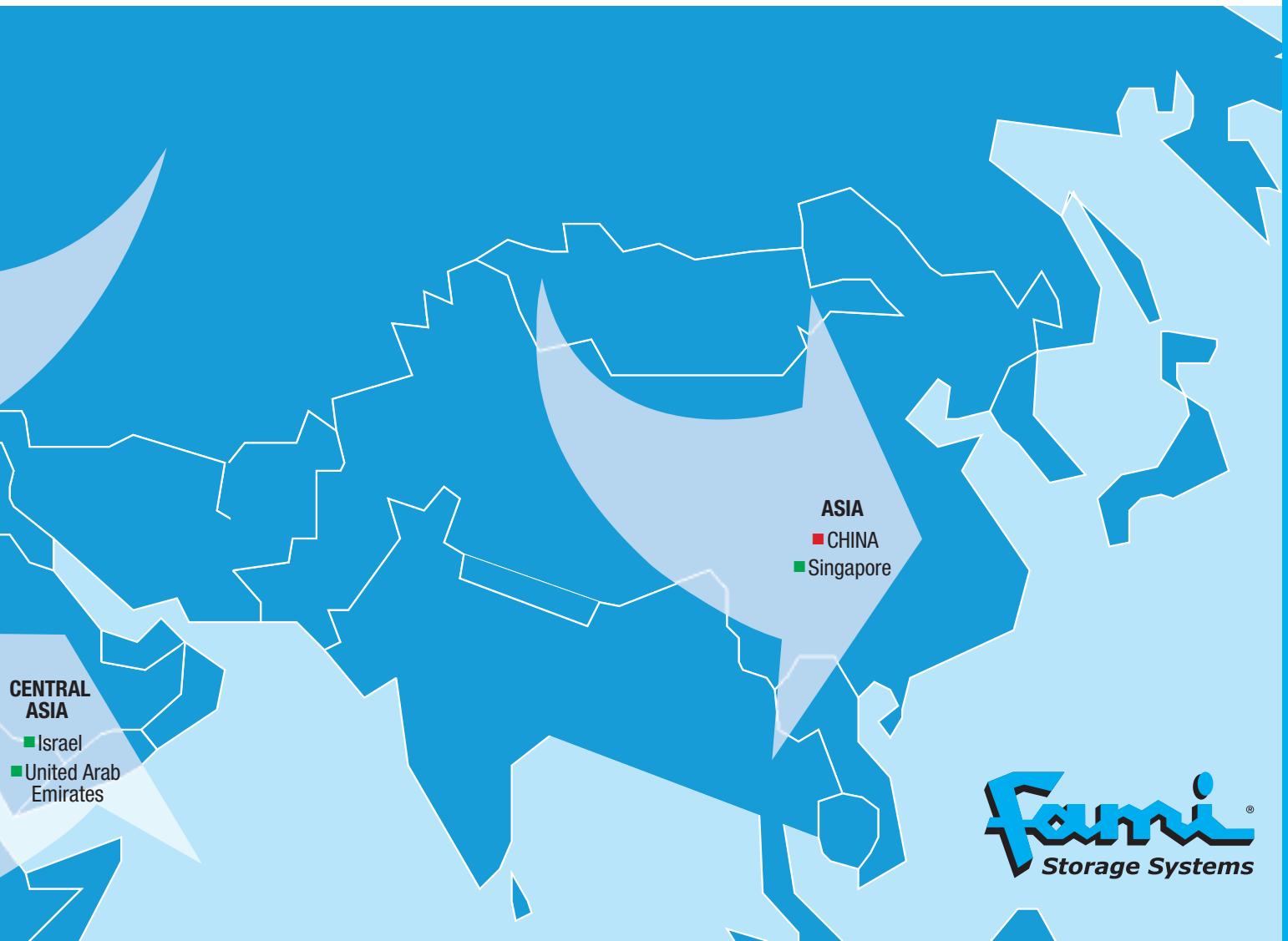

STORE VAN

STORE VAN ON THE MOVE

Store Van, a FAMI group trademark.

Constant attention to market trends together with custom details is the winning strategy of the latest Fami product: the **Store Van** trademark. **Store Van** is the trademark of fittings for commercial vehicles of all makes. The extreme care in the design of the modules and adaptability to custom solutions have demonstrated the quality and superiority of **Store Van** in every detail. The success of **Store Van** has resulted in it becoming one of the most accredited and used trademarks by international manufacturers of commercial vehicles. **Store Van** was the first to introduce an original installation method that does not involve making holes in the bodywork to fix the tools and ensures functionality, quality, strength and design to individual professionals and to large fleets.



**PROFESSIONALITY
IN MOVEMENT**



INFO ■

www.famispa.com

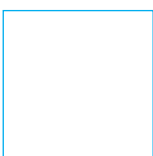
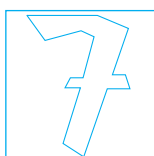

MIAL INDUSTRIAL DESIGN

STORAGE WORKSHOP LOGISTIC OFFICE COMMUNITY

MIAL Srl is a commercial branch dedicated to direct sales and mail order sales of articles to organise and furnish industrial spaces.

MIAL is a company made up of young experts who day after day have interpreted the sales sector in a dynamic, flexible and versatile way offering a choice of articles selected for their high quality and conformity to Italian and European standards. A new way of being close to our customers, with an excellent service and immediate response.



MIAL INDUSTRIAL DESIGN



■ INFO



www.famispa.com

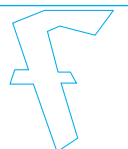

QUALITY SYSTEMS

QUALITY SYSTEMS FOR LOGISTICS

Fami's strategy is based on the adaptability of the product and ability to create unique and personalised projects. Thanks to this it is possible to study systems to satisfy all customer requirements adopting leading-edge industrial processes.

Fami is a leader in industrial fittings and gives priority not to technology only but also to the human aspect and design; for this reason every product bears the Fami name, confirming that it is a great company with a correct balance between technology and heart.

Fami is characterised by leading-edge technology and original solutions such as the industrial storage system, workstations and conductive systems for the electronics industry. They are all advanced solutions suitable for different applications and diversified requirements. They have earned **Fami** the position of leader in this sector, for competence and competitiveness.

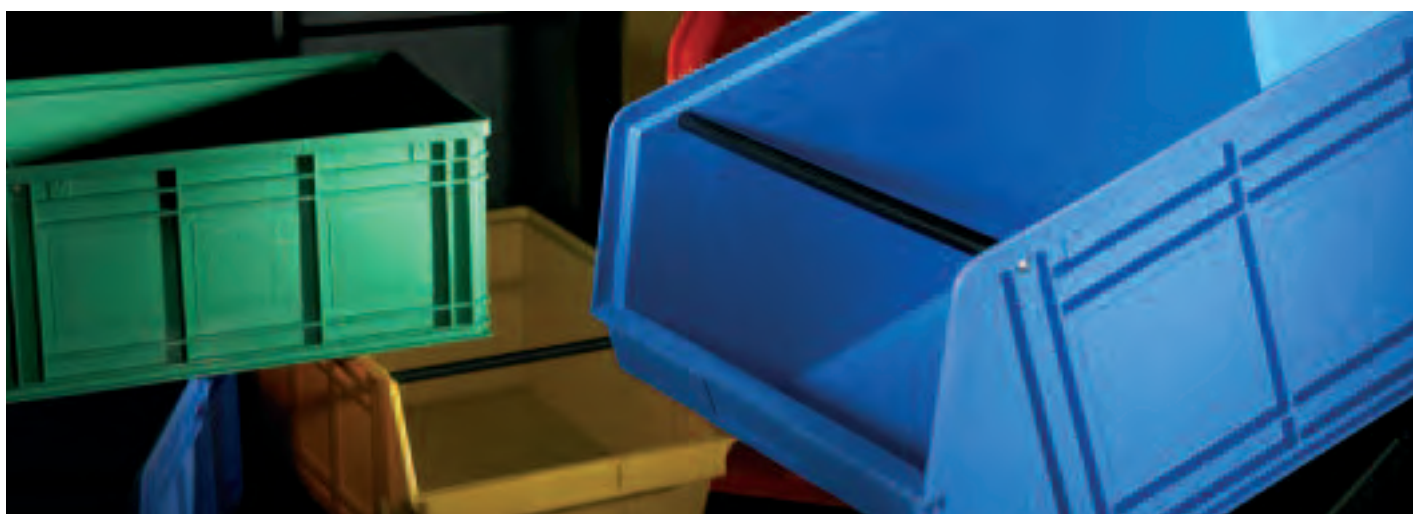

TECHNICAL INTRODUCTION TO THE CATALOGUE

ARTICLES

All **FAMI** articles are made up of an 11 digit alphanumeric code (example 1).

The last two digits identify the colour code of the photographed item. A table (example 1) next to each article shows all colours available at no extra charge. To order the product in the desired colour just replace the last two digits with the two digits of the chosen colour (example 2).

Example 1

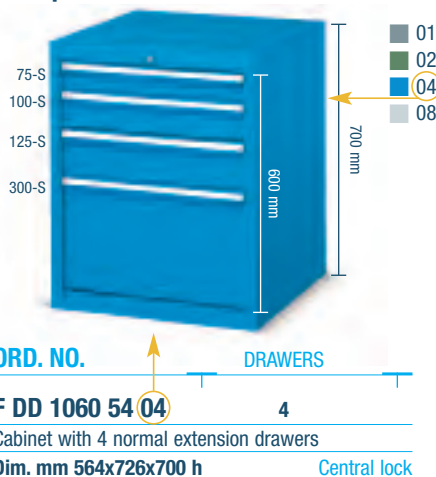

Example 2

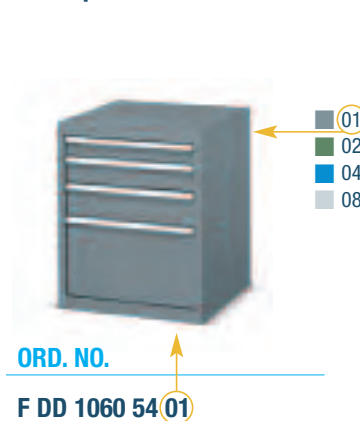

DIMENSIONS

The dimensions of Fami products are expressed in millimetres and must be read in the order L x D x H mm as shown in the picture. Letter L is the length, letter D the depth and letter H the height.

Example: dim. L x D x H mm = dim. 564x726x900 mm h



DOWNLOAD CATALOGUES IN PDF FORMAT

Various catalogues of the FAMI GROUP can be downloaded from the website.

www.famispa.com/IT/Download/Cataloghi/cataloghi.aspx

SYMBOLS



WARNING

it is important to pay particular attention to information marked with this symbol.



FOR FOOD

Boxes and containers with this symbol are produced with atoxic material therefore they are suitable for food-contact use.



POLYPROPYLENE

Boxes and containers with this symbol are made of completely recyclable plastic material.

Technical data contained in this catalogue is approximate. FAMI SpA reserves the right to make any modifications it may deem necessary to improve the aesthetics and functionality of its products. **The manufacturing company shall not be liable for any printing errors.**

INFO



www.famispa.com

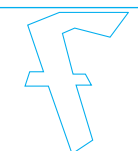

EH UNIT

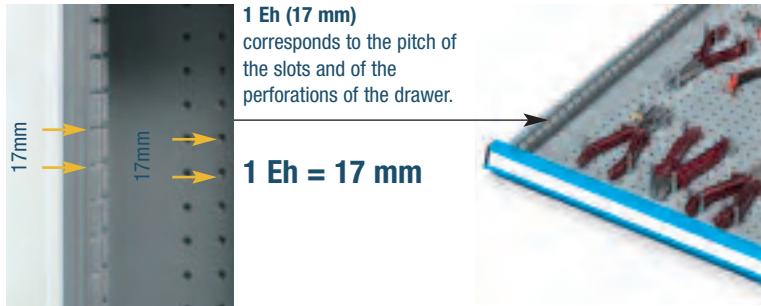

FLEXA 19x27 Eh

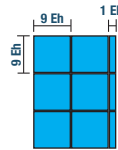
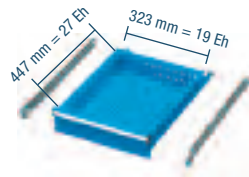

Dimensions 428x600 mm

Usable dimensions 323x447 mm

FLEXA 27x27 Eh

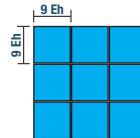
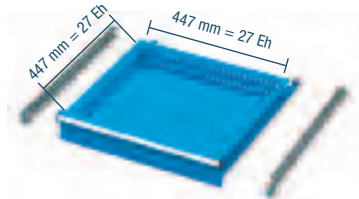

Dimensions 564x600 mm

Usable dimensions 447x447 mm

FLEXA 27x36 Eh

STANDARD GE

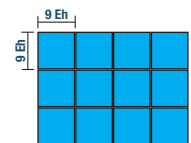
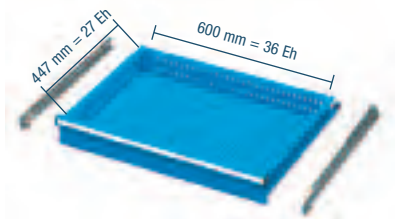

Dimensions 717x600 mm

Dimensions 717x573 mm

Usable dimensions 600x447 mm

FLEXA 54x27 Eh

STANDARD GF

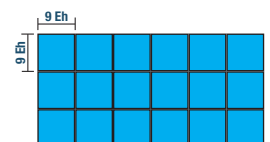
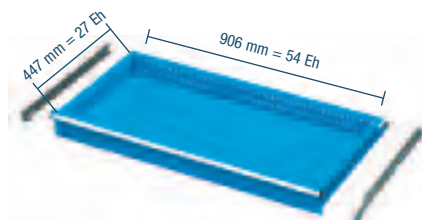

Dimensions 1023x600 mm

Dimensions 1023x573 mm

Usable dimensions 906x447 mm

INFO





Dimensions 564x726 mm

STANDARD B

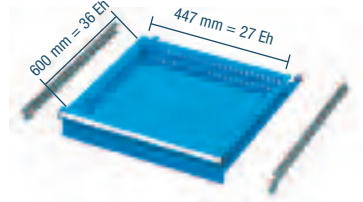

Usable dimensions 447x600 mm

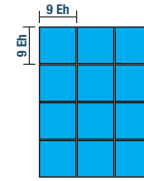

Dimensions 717x726 mm

STANDARD G

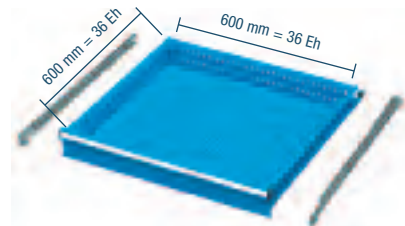

Usable dimensions 600x600 mm

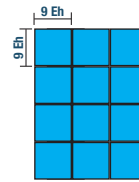

Dimensions 870x726 mm

STANDARD GG

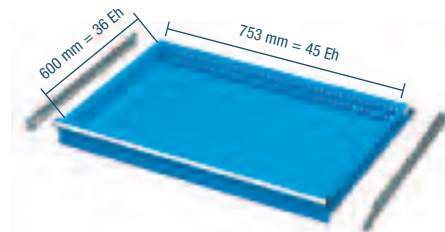

Usable dimensions 753x600 mm

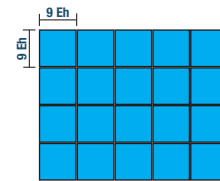

Dimensions 1023x726 mm

STANDARD GB

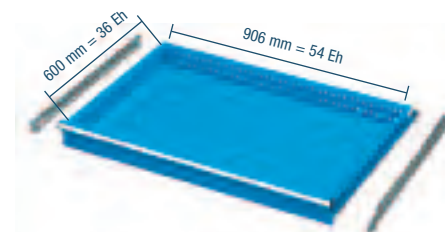

Usable dimensions 906x600 mm

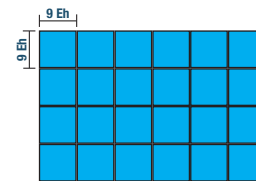

Dimensions 1193x726 mm

STANDARD GC

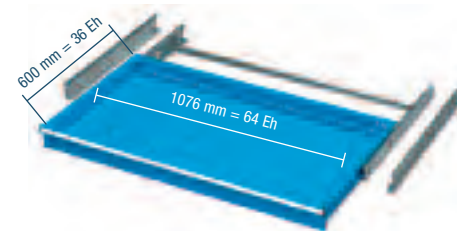

Usable dimensions 1076x600 mm

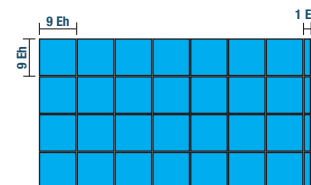

■ INFO

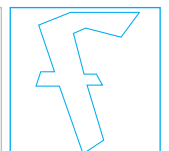
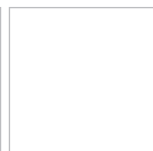
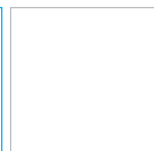
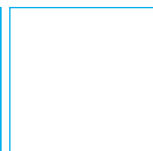

1 Eh = 17 mm

STANDARD GD

Dimensions 1431x726 mm

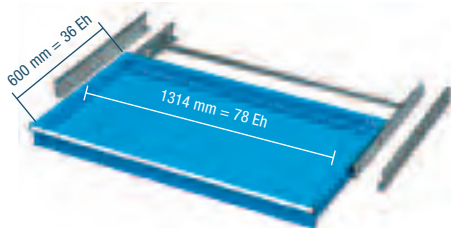

Usable dimensions 1314x600 mm

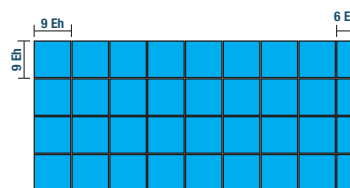
**STANDARD F27**

Dimensions 717x597 mm



Dimensions 717x597 mm



Dimensions 1431x632 mm

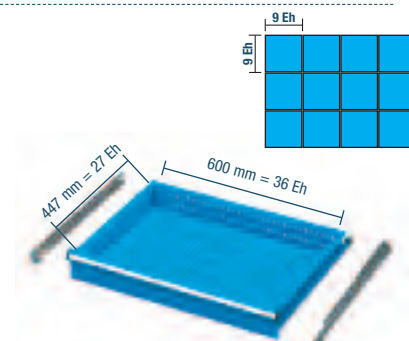

Usable dimensions 600x447 mm

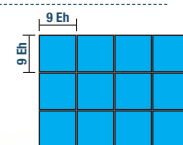
**STANDARD F36**

Dimensions 717x750 mm



Dimensions 717x750 mm



Dimensions 1431x785 mm

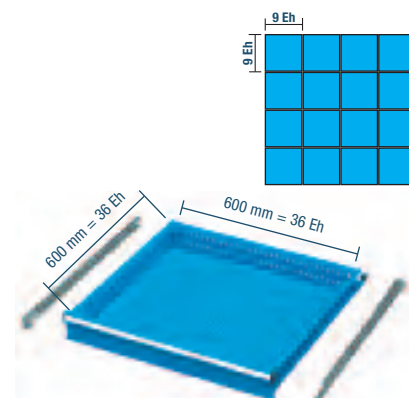

Usable dimensions 600x600 mm

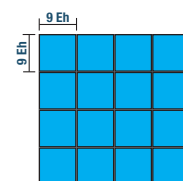
**PERFORM A110**

Dimensions 512x555 mm

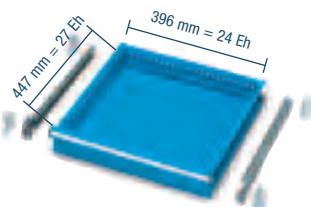

Usable dimensions 396x447 mm

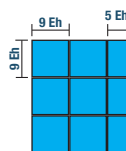
**PERFORM A120**

Usable dimensions 396x447 mm

Usable dimensions 906x447 mm



Dimensions 1023x555 mm

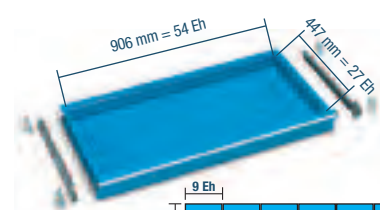
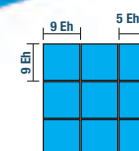
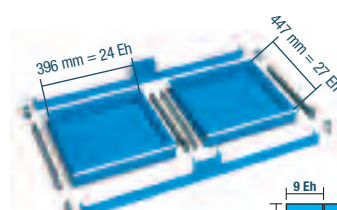



Dimensions 1195x555 mm

PERFORM A140

Usable dimensions 396x447 mm

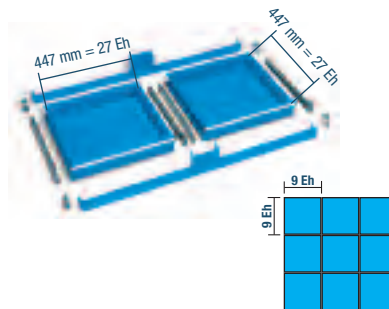

Usable dimensions 906x447 mm

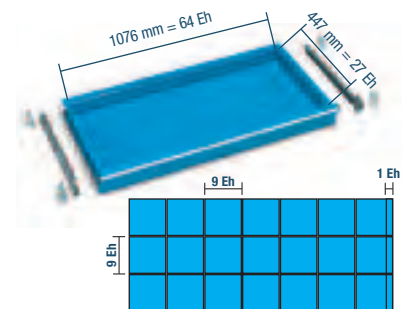

Dimensions 1023x555 mm



Dimensions 1023x555 mm

PERFORM A130 - A220

Usable dimensions 396x447 mm

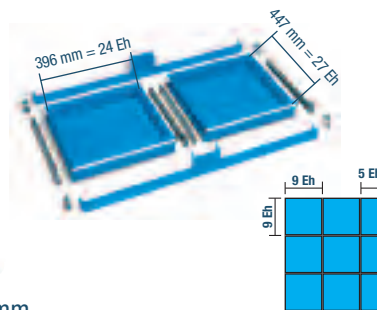

Usable dimensions 906x447 mm

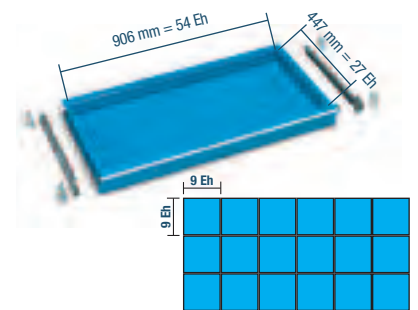

Dimensions 2046x600 mm

PERFORM A800

Usable dimensions 396x447 mm

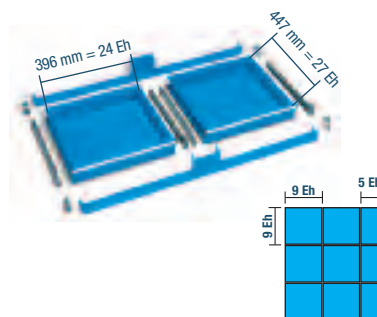

Usable dimensions 906x447 mm

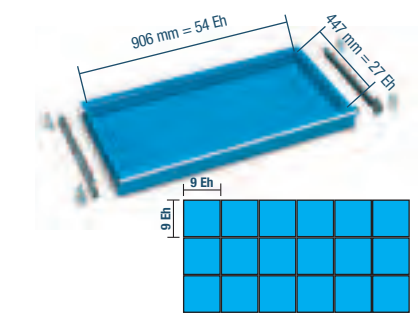

Dimensions 1023x600 mm





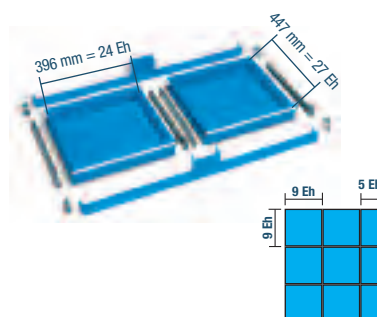

PERFORM A400

Usable dimensions 396x447 mm



CABINETS

A0 CABINETS SERIES FLEXA

<p>Page A2 FLEXA F DA / F DZ 19x27Eh 428x600 mm</p> 			
<p>Page A10 FLEXA F DB / F DC 27x27Eh 564x600 mm</p> 			
<p>Page A20 FLEXA F DF / F DG 36x27Eh 717x600 mm</p> 			
<p>Page A30 FLEXA F DL / F DM 54x27Eh 1023x600 mm</p> 			
<p>Page A38 FLEXA F CB</p> 			
<p>Page A52 WHEELS</p> 			







A56 CABINETS SERIES STANDARD

<p>Page A58 SINGLE LOCKS</p> 	<p>Page A122 STANDARD GC 64x36Eh 1193x726 mm</p> 	<p>Page A166 STANDARD FO 36x36Eh 717x750 mm</p> 	
<p>Page A60 STANDARD B 27x36Eh 564x726 mm</p> 	<p>Page A130 STANDARD GD 78x36Eh 1431x726 mm</p> 	<p>Page A172 STANDARD CS 717x635 mm</p> 	
<p>Page A74 STANDARD GE 36x27Eh 717x573 mm</p> 	<p>Page A138 STANDARD FG-FI 1431x726 mm</p> 	<p>Page A180 STANDARD H</p> 	
<p>Page A82 STANDARD G 36x36Eh 717x726 mm</p> 	<p>Page A144 STANDARD FL-G Profondità 36Eh 726 mm</p> 		
<p>Page A98 STANDARD GG 45x36Eh 870x726 mm</p> 	<p>Page A148 STANDARD F DA Profondità 27Eh 554 mm</p> 		
<p>Page A106 STANDARD GF 54x27Eh 1023x573 mm</p> 	<p>Page A150 STANDARD F27 36x27Eh 717x597/632 mm</p> 		
<p>Page A114 STANDARD GB 54x36Eh 1023x726 mm</p> 	<p>Page A158 STANDARD F36 36x36Eh 717x750/785 mm</p> 		

A192 CABINETS SERIES PERFORM



























<p>Page A194 PERFORM A110 24x27 Eh 512x555 mm</p> 	<p>Page A224 PERFORM-A 27x27 Eh - 24x27Eh 64x27 Eh - 54x27Eh</p> 	<p>Page A260 PERFORM 1200 700x270 mm</p> 	<p>Page A276 PERFORM GS250 Compartments 400x500 mm</p> 
<p>Page A198 PERFORM A120 24/57x27 Eh 1023x555 mm</p> 	<p>Page A226 PERFORM A700 2046x450 mm</p> 	<p>Page A267 PERFORM GS501 585x402 mm</p> 	<p>Page A278 PERFORM GS160/260 Compartments 400x500 mm</p> 
<p>Page A202 PERFORM A140 24/64x27 Eh 1194x555 mm</p> 	<p>Page A232 PERFORM A500 1500x450 mm</p> 	<p>Page A268 PERFORM GS110 1023x555 mm</p> 	<p>Page A280 PERFORM GS170/180 Compartments 585x500 mm</p> 
<p>Page A206 PERFORM LOOK</p> 	<p>Page A238 PERFORM A300 1023x450 mm</p> 	<p>Page A269 PERFORM GS120 585x500 mm</p> 	<p>Page A282 PERFORM GS190 Compartments 300x500 mm</p> 
<p>Page A208 PERFORM A124 54x27/24x27 Eh 1023x400 mm</p> 	<p>Page A242 PERFORM A800 2046x600 mm</p> 	<p>Page A270 PERFORM GS130/230 Compartments 300x500 mm</p> 	<p>Page A283 PERFORM FS700/730 Compartments 300/400x500 mm</p> 
<p>Page A212 PERFORM A130 24x27Eh - 54x27Eh 1023x555 mm</p> 	<p>Page A248 PERFORM A600 24x27Eh - 54x27Eh 1500x600 mm</p> 	<p>Page A272 PERFORM GS140/240 Compartments 400x500 mm</p> 	<p>Page A284 PERFORM FS1000/1100/1200 Compartments 300/400x500 mm</p> 
<p>Page A220 PERFORM A220 1023x555 mm</p> 	<p>Page A254 PERFORM A400 1023x600 mm</p> 	<p>Page A274 PERFORM GS150 Compartments 400x500 mm</p> 	<p>Page A286 PERFORM GS/FS Accessories</p> 

B0 SERIES NC

<p>Page B2 NC-TOOL</p> 			
<p>Page B8 NC-COMBI</p> 			
<p>Page B20 NC-PERFORM</p> 			
<p>Page B30 NC-SYSTEM</p> 			
<p>Page B48 NC-STANDARD F27</p> 			
<p>Page B58 NC-STANDARD F36</p> 			

WORKSTATIONS / TROLLEYS / SHELVING SYSTEM













C0 WORKSTATIONS SERIES WORK

<p>Page C2 WOODEN WORKTOPS</p> 	<p>Page C28 WORK-ROL 15-80/75 Length 1500 mm</p> 	<p>Page C44 WORK-SYSTEM 25-75 Length 2500 mm</p> 	<p>Page C56 WORK-LOOK 30 Length 3000 mm</p> 
<p>Page C4 WORK 13-80/75 Length 1300 mm</p> 	<p>Page C29 WORK-ROL 20-80/75 Length 2000 mm</p> 	<p>Page C45 WORK-SYSTEM 30-75 Length 3000 mm</p> 	<p>Page C58 WORK-LOOK Components</p> 
<p>Page C8 WORK 15-80/75 Length 1500 mm</p> 	<p>Page C30 WORK Components</p> 	<p>Page C46 WORK-SYSTEM Components</p> 	<p>Page C72 WORK-STEEL</p> 
<p>Page C12 WORK 20-80/75 Length 2000 mm</p> 	<p>Page C35 WORK-FLEXA Components</p> 	<p>Page C48 WORK-LOOK 10 Length 1000 mm</p> 	<p>Page C76 WORK-SEAT</p> 
<p>Page C16 WORK 25-80/75 Length 2500 mm</p> 	<p>Page C36 WORK-ESA</p> 	<p>Page C50 WORK-LOOK 15 Length 1500 mm</p> 	<p>Page C77 WORK-BLOCK</p> 
<p>Page C20 WORK 30-80/75 Length 3000 mm</p> 	<p>Page C40 WORK-SYSTEM 15-75 Length 1500 mm</p> 	<p>Page C52 WORK-LOOK 20 Length 2000 mm</p> 	
<p>Page C24 WORK-ROL 13-80/75 Length 1300 mm</p> 	<p>Page C42 WORK-SYSTEM 20-75 Length 2000 mm</p> 	<p>Page C54 WORK-LOOK 25 Length 2500 mm</p> 	















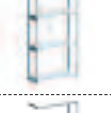







D0 TROLLEYS / SHELVING SYSTEMS / WORKSTATIONS SERIES UNIMOD

<p>Page D3 TROLLEYS SMART 101 1023x613x1430 mm h</p> 	<p>Page D22 SHELVING SYSTEMS SLICK 1065x542x1813 mm h</p> 	<p>Page D28 WORKSTATIONS COMFORT Length 4505 mm</p> 	<p>Page D46 WORKSTATIONS DYNAMIC Length 3520 mm</p> 
<p>Page D4 TROLLEYS SMART 102 1023x613x1430 mm h</p> 		<p>Page D33 WORKSTATIONS COMFORT Length 2050 mm</p> 	<p>Page D50 WORKSTATIONS DYNAMIC Length 1065 / 2050 mm</p> 
<p>Page D10 TROLLEYS SMART 103 1023x613x1430 mm h</p> 		<p>Page D34 WORKSTATIONS COMFORT Length 1065 mm</p> 	<p>Page D56 WORKSTATIONS DYNAMIC Length 1550 mm</p> 
<p>Page D12 TROLLEYS SMART 073 724x613x1430 mm h</p> 		<p>Page D35 WORKSTATIONS COMFORT Length 1550 / 2050 mm</p> 	<p>Page D58 WORKSTATIONS DYNAMIC Length 2050 mm</p> 
<p>Page D16 TROLLEYS SMART Components</p> 		<p>Page D40 WORKSTATIONS COMFORT Components</p> 	<p>Page D60 WORKSTATIONS DYNAMIC Components</p> 
			<p>Page D66 ACCESSORIES FOR SLICK / COMFORT / DYNAMIK</p> 

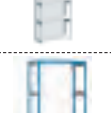
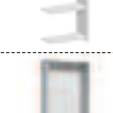
E0 TROLLEYS SERIES COMBI



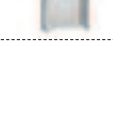
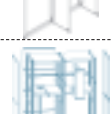















Page E2 WHEELS 	Page E34 COMBI CK 1424x825x1800 mm h 		
Page E8 COMBI CE 1135x700x1000 mm h 1420x825x1000 mm h 	Page E38 COMBI CG 1425x525x1490 mm h 		
Page E14 COMBI CF1 945x525x1045 mm h 	Page E42 COMBI CH 1425x625x1590 mm h 		
Page E18 COMBI CF2 1135x625x1045 mm h 	Page E46 COMBI CR 		
Page E22 COMBI CL1 945x525x1435 mm h 	Page E48 COMBI CP1 		
Page E26 COMBI CL2 1135x625x1435 mm h 			
Page E30 COMBI CI 1424x825x1200 mm h 			

F0 SHELVING SYSTEMS SERIES SYSTEM

Page F2 SYSTEM ST Safety 	Page F20 SYSTEM SV Safety 	Page F34 SYSTEM AR Safety 	Page F42 SYSTEM SR Safety 
Page F4 SYSTEM ST20 	Page F21 SYSTEM SV-DUAL DOCS 	Page F36 SYSTEM AR Components 	Page F44 SYSTEM SR Depth 553 mm 
Page F5 SYSTEM ST22 	Page F22 SYSTEM SV-DOCS 	Page F38 SYSTEM AR Full extension shelves 	Page F51 SYSTEM SR 0553 Accessories for 553 mm depth 
Page F6 SYSTEM ST25 	Page F24 SYSTEM SV21 	Page F40 SYSTEM AR Normal extension shelves 	Page F52 SYSTEM SR Depth 705 mm 
Page E7 SYSTEM ST30 	Page F25 SYSTEM SV23 	Page F41 SYSTEM AR Doors 	Page F62 SYSTEM SR 0705 Accessories for 705 mm depth 
Page E8 SYSTEM ST Components 	Page F26 SYSTEM SV Components 		Page F63 SYSTEM SR 1000 Doors and ladder for shelving systems 
			Page F66 SYSTEM SR V1 - V4 Vertical drawers 

CONTAINERS

GO STACKING AND STORAGE CONTAINERS SERIES STORAGE

<p>Page G2 STORAGE ATHENA</p> 	<p>Page G28 STORAGE ZEUS</p> 	<p>Page G58 STORAGE GOLD BOX</p> 	<p>Page G101 STORAGE BIG PLAST</p> 
<p>Page G16 STORAGE KLT</p> 	<p>Page G29 STORAGE ZEUS-COMPAT</p> 	<p>Page G59 STORAGE SECURITY STORAGE SHELL</p> 	
<p>Page G18 STORAGE ODETTE</p> 	<p>Page G34 STORAGE STEEL</p> 	<p>Page G60 STORAGE SYSTEM TR</p> 	
<p>Page G21 STORAGE THEMA</p> 	<p>Page G36 STORAGE STEEL</p> 	<p>Page G66 STORAGE DOMINO</p> 	
<p>Page G22 STORAGE MINERVA</p> 	<p>Page G38 STORAGE STEEL</p> 	<p>Page G70 STORAGE ESD</p> 	
<p>Page G24 STORAGE DELTA</p> 	<p>Page G42 STORAGE MULTIBOX</p> 	<p>Page G92 STORAGE MAT</p> 	
<p>Page G26 STORAGE NETTUNO</p> 	<p>Page G48 STORAGE PRACTIBOX</p> 	<p>Page G94 STORAGE BIG STEEL</p> 	

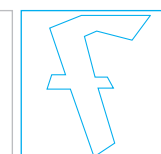
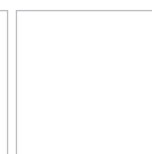
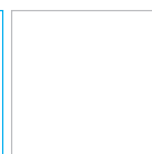

■ CABINETS SERIES FLEXA	
Cabinets with drawers	A 2
Mobile workstations	A 38
Wheels	A 52
■ CABINETS SERIES STANDARD	
Cabinets with drawers	A 57
Cabinets with doors	A 138
Cabinets for oils	A 166
Cabinets for computers	A 172
Partitioning material	A 180
■ CABINETS SERIES PERFO	
Cabinets with leaf doors	A 194
Cabinets with roller shutter	A 220
Cabinets with sliding doors	A 226
Container cabinets	A 260
PRACTIBOX	A 264
Lockers	A 266
■ SERIES NC	
Tool holders	B 2
Tool trolleys	B 08
Wheels	B 18
Tool cabinets	B 20
Tool shelving systems	B 30
Cabinets with doors	B 48
■ SERIES UNIMOD	
Trolleys series SMART	D 2
Shelving systems series SLICK	D 22
Workstations series COMFORT	D 28
Workstations series DYNAMIC	D 46
Accessories	D 66
■ SERIES COMBI	
Wheels	E 2
Modular trolleys	E 08
■ SERIES SYSTEM	
Shelving systems	F 2
Tool shelving systems with drawers	F 48
■ SERIES STORAGE	
Polypropylene stacking containers	G 2
Polypropylene storage containers	G 28
Metal stacking and storage containers	G 34
MULTIBOX boxes	G 42
PRACTIBOX containers	G 48
Wall shelving system	G 50
Cabinets series PRACTIBOX	G 56
Stacking containers series GOLD BOX	G 58
Covers series SECURITY / SHELL	G 59
Shelving systems series SYSTEM	G 60
Conductive stacking containers	G 70
Non-slip mat	G 92
Steel and plastic containers	G 94

■ INFO



ORGANIZE SPACE

LET'S REORG

- **DRAWER CABINETS SERIES FLEXA**

FULL EXTENSION DRAWERS AS STANDARD (100%)

STANDARDISED ELECTRIC AND PNEUMATIC SYSTEMS

VERSATILE

GOOD COMPARISON BETWEEN QUALITY AND PRICE



MAXIMIZE SPACE

LET'S REORG

CABINETS SERIES FLEXA

LENGTH = 428 mm DEPTH = 600 mm (19x27 Eh)



ORD. NO. F DA D550 04 01
RAL 7000

ORD. NO. F DA 1090 S1 08
RAL 7035

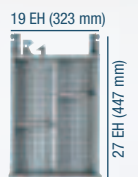

FLOOR FIXING SET



2x

- 2 "HILTI" plugs for concrete floors \geq to classes B25/RBK250/MP_A 25 N/mm²
- Recommended traction of the plug: 2.9 KN
- Plug diameter: \varnothing 6 mm

ORD. NO. F AG 9204 00 99

CABINET WITH WHEELS

ORD. NO.	DRAWERS
F DA D550 04 01	5
Complete with 5 drawers	
Dimensions mm 428x675x790 h	
Partitioning material excluded	

CABINET

ORD. NO.	DRAWERS
F DA 1090 S1 08	3
Complete with 3 drawers, 1 600 mm high door	
1 adjustable shelf, 1 retractable shelf	
1 rubber cover top with 3 edges	
Dimensions mm 428x600x1000 h	

RAL 7000 F.01

RAL 6011 F.02

RAL 5012 F.04

RAL 7035 F.08

SUPPLEMENTARY PARTS ■



- Partitioning material: see page A9



- **Spare key.** Always indicate the number on the cylinder lock of the key to be replaced.
ORD. NO. R CSC 0002 00
- **Master key.** This type of key opens all the 45 and 46 series locks.
ORD. NO. R CSC 0001 00



LENGTH = 428 mm DEPTH = 600 mm (19x27 Eh)

CABINETS SERIES FLEXA



•ORD. NO. DRAWERS
F DZ 1020 51 04 2
 Cabinet with 2 full extension drawers
 Dim. mm 428x600x300 h Side lock



•ORD. NO. DRAWERS
F DZ 1020 52 04 2
 Cabinet with 2 full extension drawers
 Dim. mm 428x600x300 h Side lock



•ORD. NO. DRAWERS
F DZ 1020 53 04 3
 Cabinet with 3 full extension drawers
 Dim. mm 428x600x300 h Side lock



•ORD. NO. DRAWERS
F DZ 1030 51 04 3
 Cabinet with 3 full extension drawers
 Dim. mm 428x600x400 h Side lock



•ORD. NO. DRAWERS
F DZ 1030 52 04 3
 Cabinet with 3 full extension drawers
 Dim. mm 428x600x400 h Side lock



•ORD. NO. DRAWERS
F DZ 1030 53 04 4
 Cabinet with 4 full extension drawers
 Dim. mm 428x600x400 h Side lock

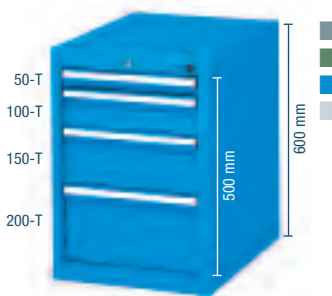

ORD. NO. DRAWERS
F DA 1050 52 04 4
 Cabinet with 4 full extension drawers
 Dim. mm 428x600x600 h Central lock

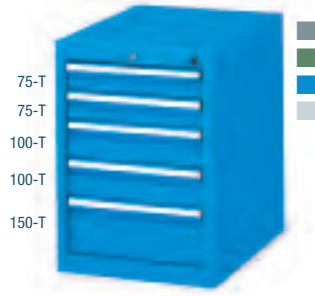

ORD. NO. DRAWERS
F DA 1050 53 04 5
 Cabinet with 5 full extension drawers
 Dim. mm 428x600x600 h Central lock

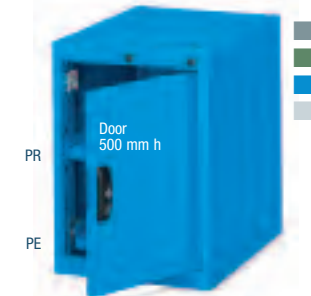

ORD. NO. SHELVES
F DA 1050 55 04 2
 Cabinet with 1 adjustable shelf, 1 retractable shelf 100%
 Dim. mm 428x600x600 h

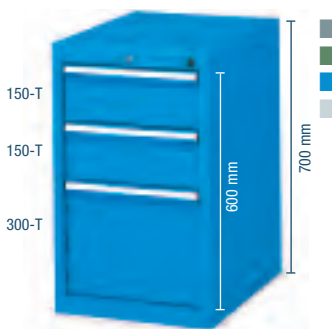

•ORD. NO. DRAWERS
F DA 1060 53 04 3
 Cabinet with 3 full extension drawers
 Dim. mm 428x600x700 h Central lock

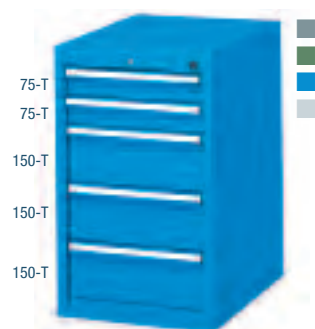

•ORD. NO. DRAWERS
F DA 1060 56 04 5
 Cabinet with 5 full extension drawers
 Dim. mm 428x600x700 h Central lock

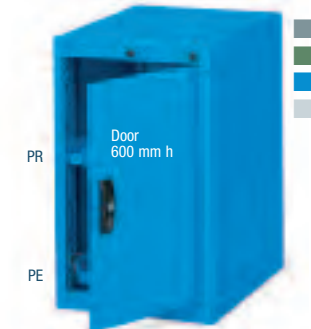

•ORD. NO. SHELVES
F DA 1060 58 04 2
 Cabinet with 1 adjustable shelf, 1 retractable shelf 100%
 Dim. mm 428x600x700 h

KEY

- RAL 7000 F.01
- RAL 6011 F.02
- RAL 5012 F.04
- RAL 7035 F.08



- The cabinets must be secured to the floor or to the wall.
- PE = full extension retractable shelf (100%)
- PR = height adjustable shelf
- T = full extension (100%)



■ Detail of the full retractable shelves (PE) with load capacity of 70 kg.

■ Partitioning material: see page A9



LENGTH = 428 mm DEPTH = 600 mm (19x27 Eh)

CABINETS SERIES FLEXA



ORD. NO. DRAWERS
F DA 1070 51 04 5
 Cabinet with 5 full extension drawers
Dimensions mm 428x600x800 h
 Central lock



ORD. NO. DRAWERS
F DA 1070 53 04 6
 Cabinet with 6 full extension drawers
Dimensions mm 428x600x800 h
 Central lock

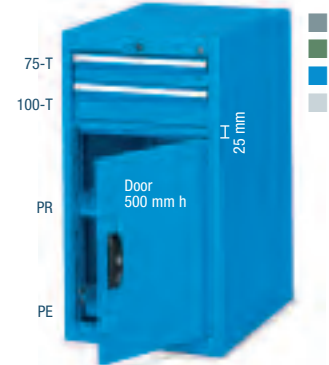

ORD. NO. DRAWERS
F DZ 1070 55 04 2
 Cabinet with 2 full extension drawers
 1 adjustable shelf, 1 retractable shelf 100%
Dim. mm 428x600x800 h Side lock

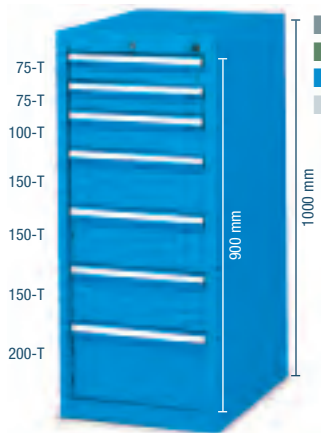

ORD. NO. DRAWERS
F DA 1090 51 04 7
 Cabinet with 7 full extension drawers
Dimensions mm 428x600x1000 h
 Central lock

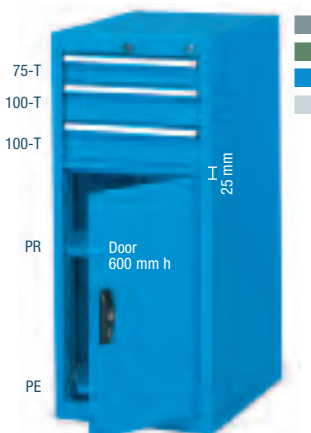

ORD. NO. DRAWERS
F DZ 1090 52 04 3
 Cabinet with 3 full extension drawers
 1 adjustable shelf, 1 retractable shelf 100%
Dim. mm 428x600x1000 h Side lock

EXAMPLE INCLUDING:

ORD. NO.
F DA ZA01 00 50
 5 cabinets with drawers, doors, adjustable shelves, retractable shelves, rubber cover MDF tops
Dimensions mm 1576x600x1030 h
 Tools excluded



■ RAL 7035 +
 ■ RAL 5012

RAL 7000 F.01 RAL 6011 F.02 RAL 5012 F.04 RAL 7035 F.08

KEY ■



■ Partitioning material: see page A9

■ Detail of the full retractable shelves (PE) with load capacity of 70 kg.



- The cabinets must be secured to the floor or to the wall.
- PE = full extension retractable shelf (100%)
- PR = height adjustable shelf
- T = full extension (100%)



LENGTH = 428 mm DEPTH = 600 mm (19x27 Eh)

CABINETS SERIES FLEXA

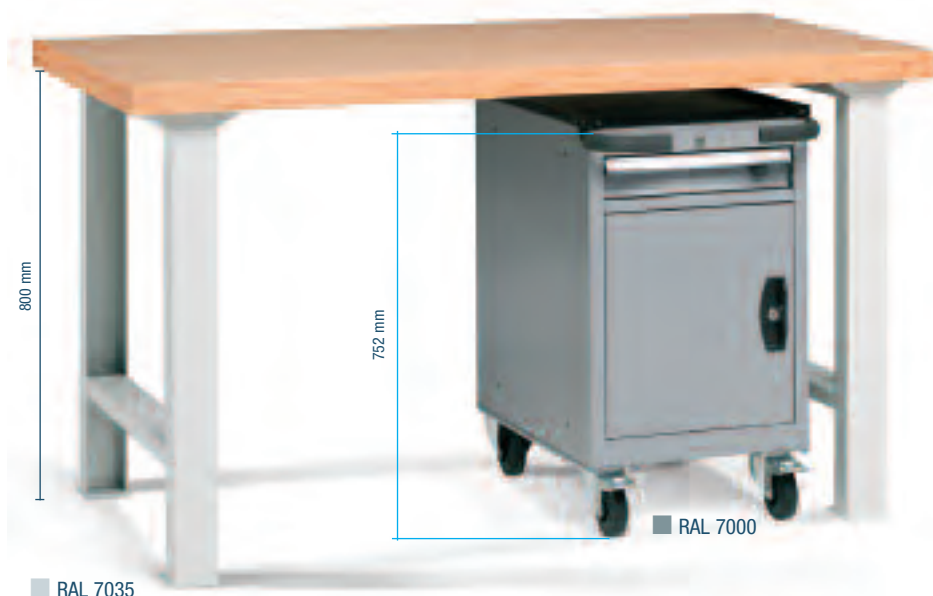

CABINET WITH WHEELS

ORD. NO.

F DA D550 06 01

Complete with 1 drawer

1 door

1 retractable shelf

Dimensions mm 428x675x752 h

WORKSTATION

ORD. NO.

F BI A242 01 08

Complete with 2 legs

40 mm thick multiplex worktop

Dimensions mm 1500x750x840 h



CABINET WITH WHEELS

ORD. NO.

F DA D560 03 56

Complete with 5 drawers

Dimensions mm 428x675x890 h

Partitioning material and tools excluded

RAL 7035 +
RAL 7000

■ INFO

RAL 7000 F.01 RAL 6011 F.02 RAL 5012 F.04 RAL 7035 F.08



www.famispa.com

■ The handles can be fitted towards the bottom thereby reducing the height by 38 mm.

■ Partitioning material: see page A180

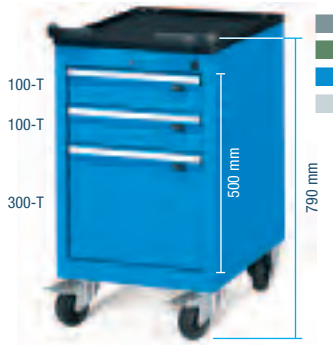

CABINETS SERIES FLEXA



ORD. NO.	DRAWERS
F DA D550 02 04	3
Cabinet with 3 full extension drawers	
Ø 100 mm standard rubber wheels	
Cabinet load capacity: 170 kg	
Dim. mm 428x675x790 h	Central lock



ORD. NO.	DRAWERS
F DA D550 03 04	4
Cabinet with 4 full extension drawers	
Ø 100 mm standard rubber wheels	
Cabinet load capacity: 170 kg	
Dim. mm 428x675x790 h	Central lock



ORD. NO.	DRAWERS
F DA D550 04 04	5
Cabinet with 5 full extension drawers	
Ø 100 mm standard rubber wheels	
Cabinet load capacity: 170 kg	
Dim. mm 428x675x790 h	Central lock



ORD. NO.	DRAWERS
F DA D560 01 04	3
Cabinet with 3 full extension drawers	
Ø 100 mm standard rubber wheels	
Cabinet load capacity: 170 kg	
Dim. mm 428x675x890 h	Central lock



ORD. NO.	DRAWERS
F DA D560 02 04	3
Cabinet with 3 full extension drawers	
Ø 100 mm standard rubber wheels	
Cabinet load capacity: 170 kg	
Dim. mm 428x675x890 h	Central lock



ORD. NO.	DRAWERS
F DA D560 03 04	5
Cabinet with 5 full extension drawers	
Ø 100 mm standard rubber wheels	
Cabinet load capacity: 170 kg	
Dim. mm 428x675x890 h	Central lock

RAL 7000 F.01 RAL 6011 F.02 RAL 5012 F.04 RAL 7035 F.08

KEY ■



■ Partitioning material: see page A9



■ The handles can be fitted towards the bottom thereby reducing the height by 38 mm.

- T = full extension (100%)
- All indicated loads are net and refer to evenly distributed weights.



LENGTH = 428 mm DEPTH = 600 mm (19x27 Eh)

CABINETS SERIES FLEXA

EMPTY CABINETS

ORD. NO.	USABLE HEIGHT mm	LOAD CAPACITY kg	DIMENSIONS mm
F DZ 1020 00 04	200	300	428x600x300 h
F DZ 1030 00 04	300	400	428x600x400 h
F DA 1050 00 04	500	900	428x600x600 h
F DA 1060 00 04	600	900	428x600x700 h
F DA 1070 00 04	700	900	428x600x800 h
F DA 1090 00 04	900	900	428x600x1000 h

■ 01 ■ 02 ■ 04 ■ 08



- Cabinets series F DA: central lock with anti-tilt rod.
- Cabinets series F DZ: side lock with side rod.
- Worktop load capacity: 80 kg

- The cabinets must be secured to the floor or to the wall. If the cabinets are stacked they must be secured to the wall and their load capacity must be divided by 2. Further information for fixing set see page A2.
- Drawers cannot be fitted behind doors.

DRAWERS

■ 01
■ 02
■ 04
■ 08

- The single drawer opening system ORD. NO. F DD 9400 00 07 must be applied to all drawers of mobile cabinets.

ORD. NO.	FRONT HEIGHT mm	LOAD CAPACITY kg	USABLE DIMENSIONS mm
F DA 8050 00 04	50	50	323x447x36 h
F DA 8075 00 04	75	70	323x447x61 h
F DA 8100 00 04	100	70	323x447x86 h
F DA 8150 00 04	150	70	323x447x136 h
F DA 8200 00 04	200	70	323x447x186 h
F DA 8300 00 04	300	70	323x447x286 h

Full extension (100%)

SPARE LOCK AND SPARE HANDLE

ORD. NO.

R CSR 0003 00

Spare lock (for central lock)

R CSR 0032 00

Spare lock (for side lock)

R CSR 0033 00

Spare lock (for doors handle)

R XDA 0002 07

Spare handle (for doors)

- Partitioning material: see page A9



RETRACTABLE SHELVES

ORD. NO.	SIDE HEIGHT mm	LOAD CAPACITY kg	USABLE DIMENSIONS mm
F DA 8000 00 04	-	70	300x475

Full extension (100%)

ADJUSTABLE SHELVES

ORD. NO.	SIDE HEIGHT mm	LOAD CAPACITY kg	USABLE DIMENSIONS mm
F DA 9100 01 04	25	70	365x460

Without extension system

TOP

ORD. NO.	DIMENSIONS mm
F DA 9150 01 07	428x600x20 h

Rubber cover top with 3 edges

Oil-resistant rubber mat

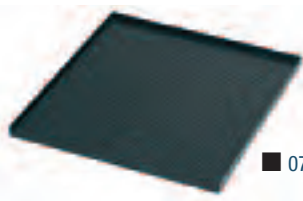

■ 07

PAIR OF PLINTHS

ORD. NO.	HEIGHT mm
F RR 1608 00 07	130

PARTIAL HEIGHT REVERSIBLE DOOR



- The door can be fitted both with left-hand and right-hand opening.

TOTAL HEIGHT REVERSIBLE DOOR

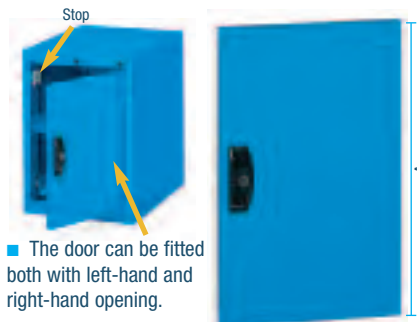

- The door can be fitted both with left-hand and right-hand opening.

■ 01 ■ 02 ■ 04 ■ 08

- Drawers cannot be fitted behind doors

ORD. NO.	HEIGHT (A) mm
F DA 9640 02 04	400+25
F DA 9645 02 04	500+25
F DA 9650 02 04	600+25

ORD. NO.	HEIGHT (A) mm
F DA 9645 01 04	500
F DA 9650 01 04	600

CATCH

ORD. NO. F DA 9698 00 99

To order with full height doors only.

■ 99



CABINETS SERIES FLEXA

UPPER MDF TOP WITH RUBBER COVERING DIMENSIONS 429x600x31,5 mm h

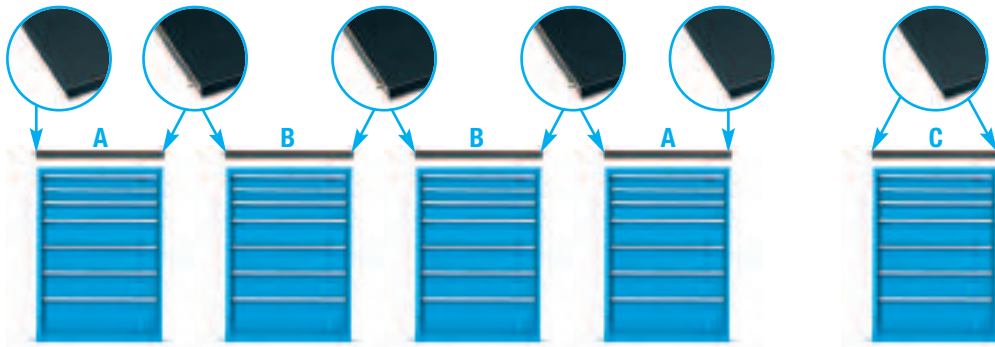

Detail of the oil-resistant rubber

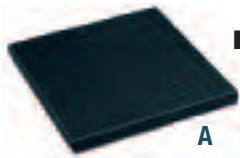

■ 07

A

ORD. NO.

F UZ 3100 11 07

MDF top with rubber covering

Side profile

For end cabinets

Oil-resistant rubber mat



■ 07

B

ORD. NO.

F UZ 3100 12 07

MDF top with rubber covering

No side profile

For additional central cabinets Oil-resist. rubber mat

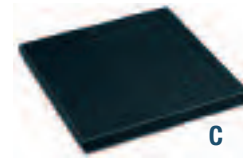

■ 07

C

ORD. NO.

F UZ 3100 13 07

MDF top with rubber covering

2 side profiles

For single cabinet

Oil-resistant rubber mat

CABINET PREPARED FOR WHEELS

Cabinet prepared for wheels including: wheel plate, 4 edged top with oil-resistant rubber, 2 steel handles covered with shock-resistant rubber, cylinder lock with 2 keys, anti-tilt rod.

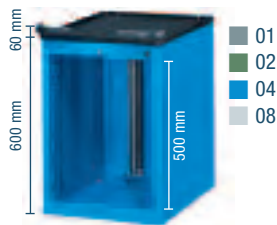

- 01
- 02
- 04
- 08

ORD. NO.

F DA 0550 00 04

Overall dim. mm 428x675x660 h without wheels

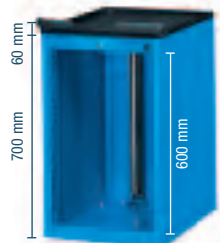

- 01
- 02
- 04
- 08

ORD. NO.

F DA 0560 00 04

Overall dim. mm 428x675x760 h without wheels



■ The single drawer opening system **ORD. NO. F DD 9400 00 07** must be applied to all drawers of mobile cabinets.



STANDARD RUBBER SWIVEL WHEEL WITH BRAKE

ORD. NO.	Ø mm	CABINET LOAD CAP.	C mm
C RG DAC11 100	100	170 kg	130
C RG DAC12 125	125	245 kg	160
C RG DAC13 150	150	290 kg	185



STANDARD RUBBER FIXED WHEEL

ORD. NO.	Ø mm	CABINET LOAD CAP.	C mm
C RG BAC11 100	100	170 kg	130
C RG BAC12 125	125	245 kg	160
C RG BAC13 150	150	290 kg	185



NYLON SWIVEL WHEEL WITH BRAKE

ORD. NO.	Ø mm	CABINET LOAD CAP.	C mm
C RN DAD10 100	100	320 kg	130
C RN DAD11 125	125	400 kg	160



NYLON FIXED WHEEL

ORD. NO.	Ø mm	CABINET LOAD CAP.	C mm
C RN BAD10 100	100	320 kg	130
C RN BAD11 125	125	400 kg	160

RAL 7000 F.01

RAL 6011 F.02

RAL 5012 F.04

RAL 7035 F.08

KEY ■



■ Other types of wheels: see page A52

■ The handles can be fitted towards the bottom thereby reducing the height by 38 mm.



■ All indicated loads are net and refer to evenly distributed weights.



LENGTH = 428 mm DEPTH = 600 mm (19x27 Eh)

CABINETS SERIES FLEXA

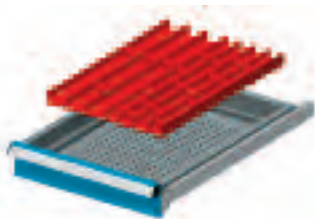

ORD. NO.	FOR FRONT HEIGHTS
F FH 8205 02 00	50-300
Set including:	
3 Troughs	4 grooves
3 Troughs	3 grooves
16 Plain partitions	36 mm
7 Plain partitions	47 mm

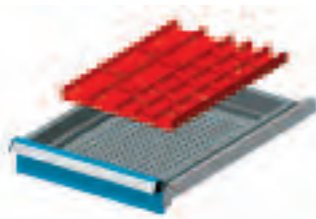

ORD. NO.	FOR FRONT HEIGHTS
F FH 8205 03 00	50-300
Set including:	
3 Troughs	3 grooves
3 Troughs	2 grooves
15 Plain partitions	47 mm
8 Plain partitions	73 mm

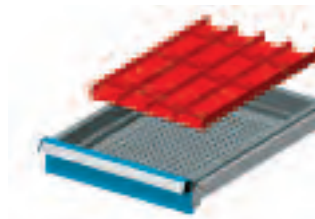

ORD. NO.	FOR FRONT HEIGHTS
F FH 8205 04 00	50-300
Set including:	
6 Troughs	2 grooves
18 Plain partitions	73 mm

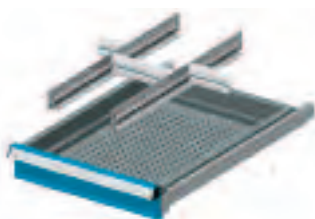

ORD. NO.	FOR FRONT HEIGHTS
F FH 8205 08 00	50
F FH 8207 08 00	75
F FH 8210 08 00	100-125
Set including:	
2 Slotted partitions	455 mm
1 Plain partition	132 mm
1 Plain partition	98 mm
1 Plain partition	81 mm

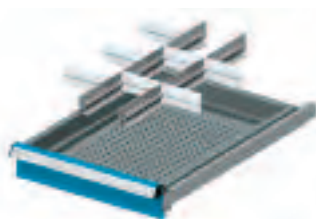

ORD. NO.	FOR FRONT HEIGHTS
F FH 8205 09 00	50
F FH 8207 09 00	75
F FH 8210 09 00	100-125
F FH 8215 09 00	150-175
Set including:	
2 Slotted partitions	455 mm
3 Plain partitions	115 mm
4 Plain partitions	98 mm

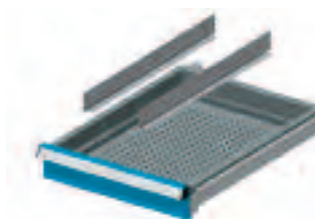

ORD. NO.	FOR FRONT HEIGHTS
F FH 8405 13 00	50
F FH 8407 13 00	75
F FH 8410 13 00	100-125
F FH 8415 13 00	150-175
F FH 8420 13 00	200-250
Set including:	
2 Plain partitions	455 mm

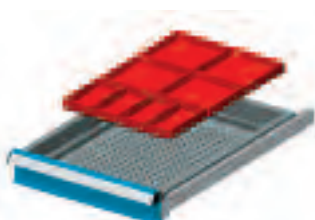

ORD. NO.	FOR FRONT HEIGHTS
F FH 8205 18 00	50
F FH 8207 18 00	75
F FH 8210 18 00	100-125
Set including:	
4 Plastic boxes	150x75 mm
4 Plastic boxes	150x150 mm

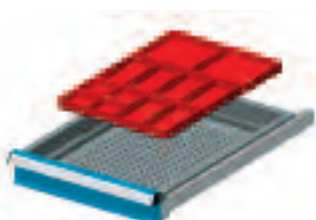

ORD. NO.	FOR FRONT HEIGHTS
F FH 8205 17 00	50
F FH 8207 17 00	75
Set including:	
4 Plastic boxes	75x75 mm
6 Plastic boxes	150x75 mm
2 Plastic boxes	150x150 mm

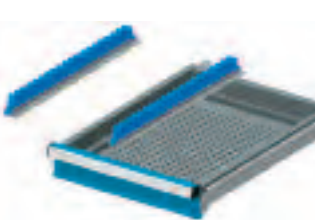

ORD. NO.	FOR FRONT HEIGHTS
F FH 8605 19 00	50-300
Set including:	
2 Multi-purpose supports	440 mm

■ INFO

www.famispa.com

■ Partitioning material: see page A180



CABINETS SERIES FLEXA



ORD. NO. F DB B560 02 EF
RAL 7000+7035



ORD. NO. F DB 1070 58 56
RAL 7035+7000

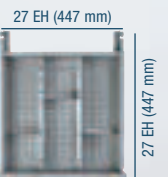

FLOOR FIXING SET



2x

- 2 "HILTI" plugs for concrete floors \geq to classes B25/RBK250/MP_A 25 N/mm²
- Recommended traction of the plug: 2.9 KN
- Plug diameter: \varnothing 6 mm

ORD. NO. F AG 9204 00 99

CABINET WITH WHEELS

ORD. NO. _____ **DRAWERS** _____

F DB B560 02 EF **5**

Complete with 5 drawers

Dimensions mm 564x675x920 h

Partitioning material excluded

CABINET

ORD. NO. _____ **DRAWERS** _____

F DB 1070 58 56 **5**

Complete with 5 drawers, 1 electric system,
1 pneumatic system, 1 pair of plinths,
1 rubber cover top with 3 edges

Dimensions mm 564x600x930 h

RAL 7000 F.01

RAL 6011 F.02

RAL 5012 F.04

RAL 7035 F.08

SUPPLEMENTARY PARTS ■



- Partitioning material: see page A19



- **Spare key.** Always indicate the number on the cylinder lock of the key to be replaced.

ORD. NO. R CSC 0002 00

- **Master key.** This type of key opens all the 45 and 46 series locks.

ORD. NO. R CSC 0001 00



LENGTH = 564 mm DEPTH = 600 mm (27x27 Eh)

CABINETS SERIES FLEXA

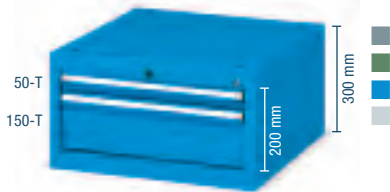

•ORD. NO. DRAWERS
F DC 1020 51 04 2
 Cabinet with 2 full extension drawers
 Dim. mm 564x600x300 h Side lock



•ORD. NO. DRAWERS
F DC 1020 52 04 2
 Cabinet with 2 full extension drawers
 Dim. mm 564x600x300 h Side lock



•ORD. NO. DRAWERS
F DC 1020 53 04 3
 Cabinet with 3 full extension drawers
 Dim. mm 564x600x300 h Side lock

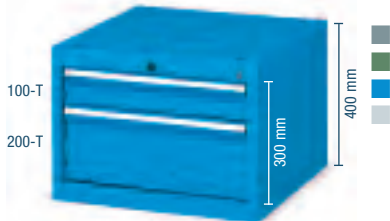

•ORD. NO. DRAWERS
F DC 1030 51 04 2
 Cabinet with 2 full extension drawers
 Dim. mm 564x600x400 h Side lock



•ORD. NO. DRAWERS
F DC 1030 52 04 2
 Cabinet with 2 full extension drawers
 Dim. mm 564x600x400 h Side lock



•ORD. NO. DRAWERS
F DC 1030 53 04 3
 Cabinet with 3 full extension drawers
 Dim. mm 564x600x400 h Side lock



ORD. NO. DRAWERS
F DB 1050 52 04 4
 Cabinet with 4 full extension drawers
 Dim. mm 564x600x600 h Central lock

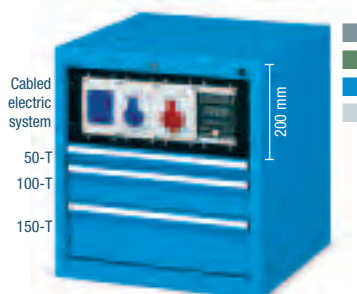

ORD. NO. DRAWERS
F DB 1050 55 04 3
 Cabinet with 3 full extension drawers,
 1 differential circuit breaker, 1 Schuko socket,
 1 CEE 220-250V socket, 1 CEE 380V socket
 Dim. mm 564x600x600 h Central lock

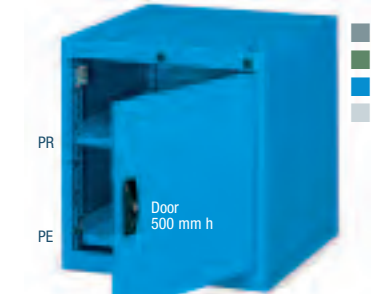

ORD. NO. SHELVES
F DB 1050 58 04 2
 Cabinet with 1 adjustable shelf,
 1 retractable shelf 100%
 Dimensions mm 564x600x600 h

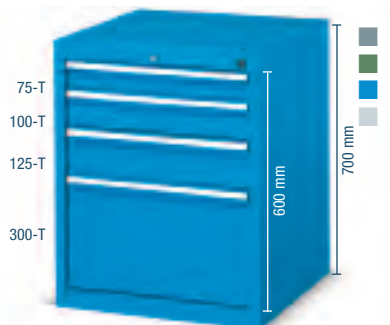

•ORD. NO. DRAWERS
F DB 1060 51 04 4
 Cabinet with 4 full extension drawers
 Dim. mm 564x600x700 h Central lock



•ORD. NO. DRAWERS
F DB 1060 52 04 5
 Cabinet with 5 full extension drawers
 Dim. mm 564x600x700 h Central lock

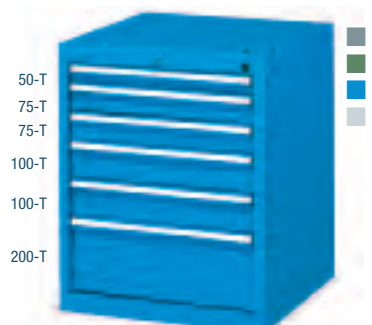

•ORD. NO. DRAWERS
F DB 1060 53 04 6
 Cabinet with 6 full extension drawers
 Dim. mm 564x600x700 h Central lock

KEY

RAL 7000 F.01 RAL 6011 F.02 RAL 5012 F.04 RAL 7035 F.08



- The cabinets must be secured to the floor or to the wall.
- PE = full extension retractable shelf (100%)
- PR = height adjustable shelf
- T = full extension (100%)



■ Detail of the full retractable shelves (PE) with load capacity of 70 kg.

■ Partitioning material: see page A19

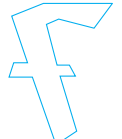

CABINETS SERIES FLEXA

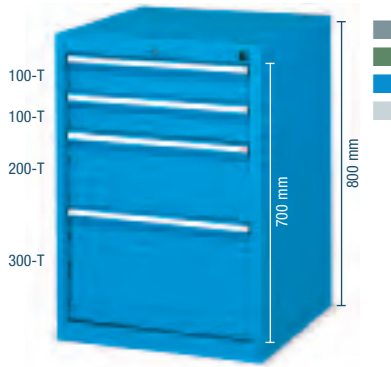

ORD. NO.	DRAWERS
F DB 1070 53 04	4
Cabinet with 4 full extension drawers	
Dimensions mm 564x600x800 h	
Central lock	



ORD. NO.	DRAWERS
F DB 1070 51 04	5
Cabinet with 5 full extension drawers	
Dimensions mm 564x600x800 h	
Central lock	

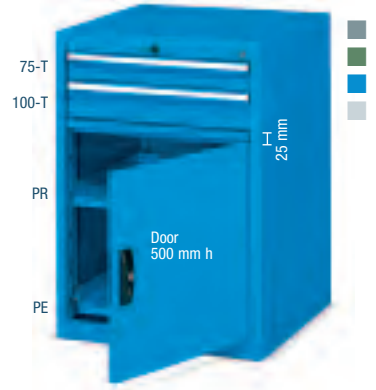

ORD. NO.	DRAWERS
F DC 1070 57 04	2
Cabinet with 2 full extension drawers, 1 adjustable shelf, 1 retractable shelf 100%	
Dim. mm 564x600x800 h	
Side lock	

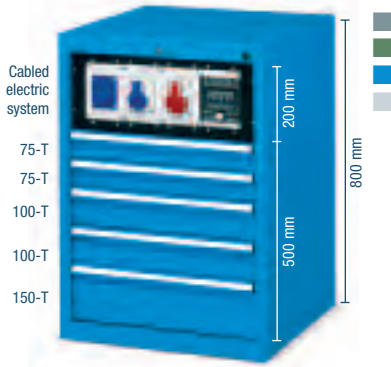

ORD. NO.	DRAWERS
F DB 1070 54 04	5
Cabinet with 5 full extension drawers	
1 differential circuit breaker	
1 Schuko socket	
1 CEE 220-250V socket	
1 CEE 380V socket	
Dimensions mm 564x600x800 h	
Central lock	

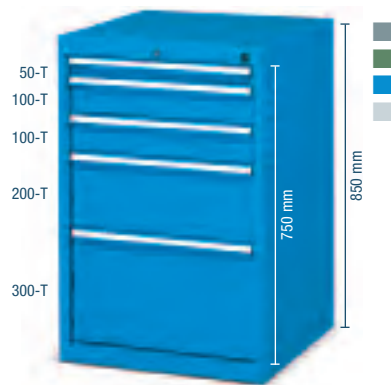

ORD. NO.	DRAWERS
F DB 1075 51 04	5
Cabinet with 5 full extension drawers	
Dimensions mm 564x600x850 h	
Central lock	



ORD. NO.	DRAWERS
F DB 1075 52 04	6
Cabinet with 6 full extension drawers	
Dimensions mm 564x600x850 h	
Central lock	

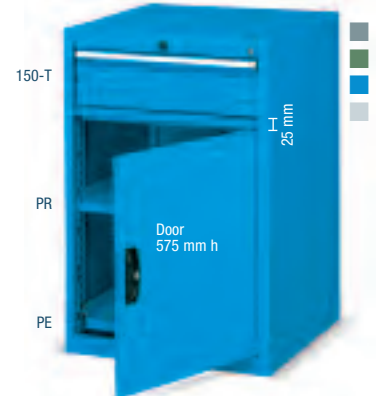

ORD. NO.	DRAWERS
F DC 1075 57 04	1
Cabinet with 1 full extension drawer, 1 adjustable shelf, 1 retractable shelf 100%	
Dimensions mm 564x600x850 h	

RAL 7000 F.01 RAL 6011 F.02 RAL 5012 F.04 RAL 7035 F.08

KEY



■ Partitioning material: see page A19

■ Detail of the full retractable shelves (PE) with load capacity of 70 kg.



- The cabinets must be secured to the floor or to the wall.
- PE = full extension retractable shelf (100%)
- PR = height adjustable shelf
- T = full extension (100%)



LENGTH = 564 mm DEPTH = 600 mm (27x27 Eh)

CABINETS SERIES FLEXA



•ORD. NO.	DRAWERS
F DB 1090 51 04	6
Cabinet with 6 full extension drawers	
Dimensions mm 564x600x1000 h	
Central lock	



•ORD. NO.	DRAWERS
F DB 1090 52 04	7
Cabinet with 7 full extension drawers	
Dimensions mm 564x600x1000 h	
Central lock	

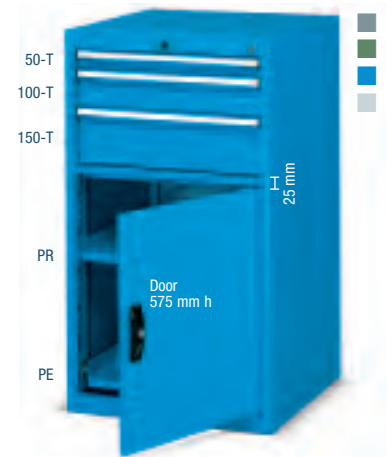

•ORD. NO.	DRAWERS
F DC 1090 56 04	3
Cabinet with 3 full extension drawers, 1 adjustable shelf, 1 retractable shelf 100%	
Dim. mm 564x600x1000 h	
Side lock	



EXAMPLE INCLUDING:

ORD. NO.

F AB ZA06 00 08

2 cabinets with drawers, partitioning material, rubber cover MDF tops,
1 cabinet with doors, adjustable shelves, boxes, rubber cover MDF top

Dimensions mm 2782x600x1030 h

Tools excluded

■ The FLEXA cabinets can be combined to the 600 mm deep F AB series cabinets. See from page A242 for further information.

■ KEY



- The cabinets must be secured to the floor or to the wall.
- PE = full extension retractable shelf (100%)
- PR = height adjustable shelf
- T = full extension (100%)



- Detail of the full retractable shelves (PE) with load capacity of 70 kg.

- Partitioning material: see page A19

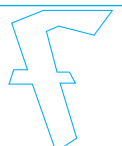

RAL 7000 F.01

RAL 6011 F.02

RAL 5012 F.04

RAL 7035 F.08

LENGTH = 564 mm DEPTH = 600 mm (27x27 Eh)

CABINETS SERIES FLEXA



ORD. NO.	DRAWERS
F DB B550 01 04	3
Cabinet with 3 full extension drawers	
Ø 125 mm standard rubber wheels	
Cabinet load capacity: 235 kg	
Dim. mm 564x675x820 h	
	Central lock



ORD. NO.	DRAWERS
F DB B550 02 04	4
Cabinet with 4 full extension drawers	
Ø 125 mm standard rubber wheels	
Cabinet load capacity: 235 kg	
Dim. mm 564x675x820 h	
	Central lock



ORD. NO.	DRAWERS
F DB B550 03 04	5
Cabinet with 5 full extension drawers	
Ø 125 mm standard rubber wheels	
Cabinet load capacity: 235 kg	
Dim. mm 564x675x820 h	
	Central lock



ORD. NO.	DRAWERS
F DB D550 01 04	3
Cabinet with 3 full extension drawers	
Ø 100 mm standard rubber wheels	
Cabinet load capacity: 160 kg	
Dimensions mm 564x675x790 h	
Central lock	



ORD. NO.	DRAWERS
F DB B560 01 04	4
Cabinet with 4 full extension drawers	
Ø 125 mm standard rubber wheels	
Cabinet load capacity: 235 kg	
Dim. mm 564x675x920 h	
	Central lock



ORD. NO.	DRAWERS
F DB B560 02 04	5
Cabinet with 5 full extension drawers	
Ø 125 mm standard rubber wheels	
Cabinet load capacity: 235 kg	
Dim. mm 564x675x920 h	
	Central lock



ORD. NO.	DRAWERS
F DB B560 03 04	6
Cabinet with 6 full extension drawers	
Ø 125 mm standard rubber wheels	
Cabinet load capacity: 235 kg	
Dim. mm 564x675x920 h	
	Central lock

RAL 7000 F.01

RAL 6011 F.02

RAL 5012 F.04

RAL 7035 F.08

KEY ■



■ Partitioning material: see page A19

■ The handles can be fitted towards the bottom thereby reducing the height by 38 mm.



- T = full extension (100%)
- All indicated loads are net and refer to evenly distributed weights.



LENGTH = 564 mm DEPTH = 600 mm (27x27 Eh)

CABINETS SERIES FLEXA



ORD. NO.	DRAWERS
F DB D560 01 04	4
Cabinet with 4 full extension drawers	
Ø 100 mm standard rubber wheels	
Cabinet load capacity: 160 kg	
Dim. mm 564x675x890 h Central lock	



ORD. NO.	DRAWERS
F DB B570 01 04	5
Cabinet with 5 full extension drawers	
Ø 125 mm standard rubber wheels	
Cabinet load capacity: 235 kg	
Dim. mm 564x675x1020 h Central lock	



ORD. NO.	DRAWERS
F DB B575 01 04	5
Cabinet with 5 full extension drawers	
Ø 125 mm standard rubber wheels	
Cabinet load capacity: 235 kg	
Dim. mm 564x675x1070 h Central lock	



ORD. NO.	DRAWERS
F DB B590 01 04	6
Cabinet with 6 full extension drawers	
Ø 125 mm standard rubber wheels	
Cabinet load capacity: 235 kg	
Dim. mm 564x675x1220 h Central lock	



ORD. NO.	DRAWERS
F DB B590 02 04	7
Cabinet with 7 full extension drawers	
Ø 125 mm standard rubber wheels	
Cabinet load capacity: 235 kg	
Dim. mm 564x675x1220 h Central lock	



ORD. NO.	DRAWERS
F DB B590 03 04	8
Cabinet with 8 full extension drawers	
Ø 125 mm standard rubber wheels	
Cabinet load capacity: 235 kg	
Dim. mm 564x675x1220 h Central lock	

KEY



- T = full extension (100%)
- All indicated loads are net and refer to evenly distributed weights.
- The cabinets must be secured to the floor or to the wall.
- Drawers cannot be fitted behind doors.



The handles can be fitted towards the bottom thereby reducing the height by 38 mm.

Partitioning material: see page A19

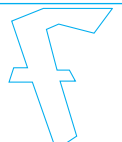

RAL 7000 F.01 RAL 6011 F.02 RAL 5012 F.04 RAL 7035 F.08

CABINETS SERIES FLEXA

EMPTY CABINETS

ORD. NO.	USABLE HEIGHT mm	LOAD CAPACITY kg	DIMENSIONS mm
F DC 1020 00 04	200	300	564x600x300 h
F DC 1030 00 04	300	400	564x600x400 h
F DB 1050 00 04	500	900	564x600x600 h
F DB 1060 00 04	600	900	564x600x700 h
F DB 1070 00 04	700	900	564x600x800 h
F DB 1075 00 04	750	900	564x600x850 h
F DB 1090 00 04	900	900	564x600x1000 h

■ 01 ■ 02 ■ 04 ■ 08



- Cabinets series F DB: central lock with anti-tilt rod.
- Cabinets series F DC: side lock with side rod.
- Worktop load capacity: 80 kg

■ The cabinets must be secured to the floor or to the wall. If the cabinets are stacked they must be secured to the wall and their load capacity must be divided by 2. Further information for fixing set see page A10.

- Drawers cannot be fitted behind doors.

DRAWERS

■ 01
■ 02
■ 04
■ 08

■ The single drawer opening system ORD. NO. F DD 9400 00 07 must be applied to all drawers of mobile cabinets.

ORD. NO.	FRONT HEIGHT mm	LOAD CAPACITY kg	USABLE DIMENSIONS mm
F DB 8050 00 04	50	50	447x447x36 h
F DB 8075 00 04	75	70	447x447x61 h
F DB 8100 00 04	100	70	447x447x86 h
F DB 8125 00 04	125	70	447x447x111 h
F DB 8150 00 04	150	70	447x447x136 h
F DB 8200 00 04	200	70	447x447x186 h
F DB 8250 00 04	250	70	447x447x236 h
F DB 8300 00 04	300	70	447x447x286 h

Full extension (100%)

SPARE LOCK AND SPARE HANDLE

ORD. NO.

R CSR 0003 00
Spare lock (for central lock)

R CSR 0032 00
Spare lock (for side lock)

R CSR 0033 00
Spare lock (for doors handle)

R XDA 0002 07
Spare handle (for doors)

- Partitioning material: see page A19

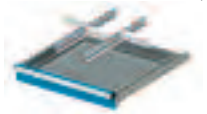

RETRACTABLE SHELVES

ORD. NO.	SIDE HEIGHT mm	LOAD CAPACITY kg	USABLE DIMENSIONS mm
F DB 8000 00 04	-	70	435x475

Full extension (100%)

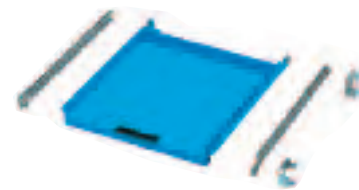
■ 01
■ 02
■ 04

ADJUSTABLE SHELVES

ORD. NO.	SIDE HEIGHT mm	LOAD CAPACITY kg	USABLE DIMENSIONS mm
F DB 9100 01 04	25	70	505x460

Without extension system

■ 01
■ 02
■ 04

TOP

ORD. NO.	DIMENSIONS mm
F DB 9150 01 07	564x600x20 h

Rubber cover top with 3 edges

Oil-resistant rubber mat

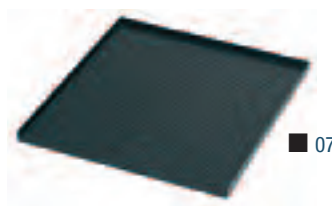

■ 07

PAIR OF PLINTHS

ORD. NO.	HEIGHT mm
F RR 1608 00 07	130



■ 07

RAL 7000 F.01 RAL 6011 F.02 RAL 5012 F.04 RAL 7035 F.08

KEY ■

- All indicated loads are net and refer to evenly distributed weights.

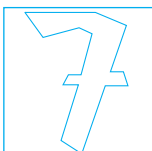

LENGTH = 564 mm DEPTH = 600 mm (27x27 Eh)

CABINETS SERIES FLEXA

PARTIAL HEIGHT REVERSIBLE DOOR



ORD. NO.	HEIGHT (A) mm
F DB 9640 02 04	400+25
F DB 9642 02 04	425+25
F DB 9645 02 04	500+25
F DB 9649 02 04	575+25
F DB 9650 02 04	600+25

TOTAL HEIGHT REVERSIBLE DOOR



ORD. NO.	HEIGHT (A) mm
F DB 9645 01 04	500
F DB 9650 01 04	600

- Drawers cannot be fitted behind doors

CATCH

ORD. NO. F DA 9698 00 99

To order with full height doors only.



■ 99



EXAMPLE INCLUDING:

ORD. NO.

F DB ZA01 00 01

2 cabinets with drawers, door, retractable shelf, adjustable shelf, rubber covered MDF tops, plinths

Dimensioni mm 1130x600x860 h

Tools and partitioning material excluded

■ INFO

RAL 7000 F.01 RAL 6011 F.02 RAL 5012 F.04 RAL 7035 F.08

- Partitioning material: see page A180



www.famispa.com



CABINETS SERIES FLEXA

UPPER MDF TOP WITH RUBBER COVERING DIMENSIONS 565x600x31,5 mm H

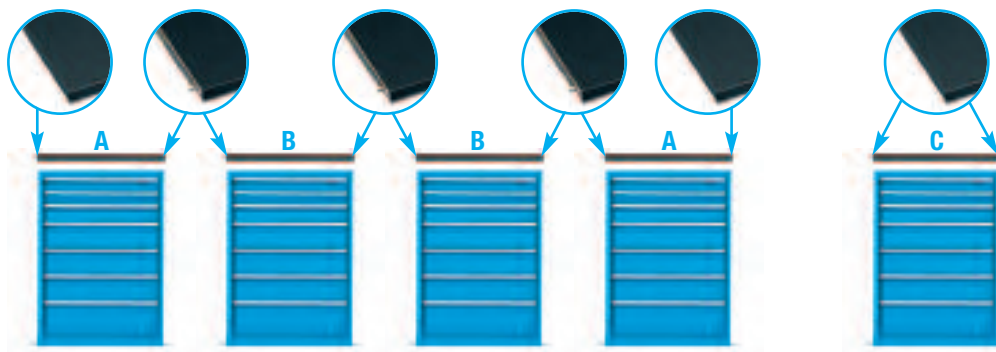

Detail of the oil-resistant rubber

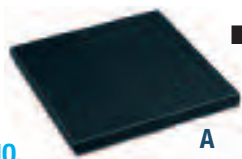

ORD. NO.

F UZ 3120 11 07

MDF top with rubber covering
Side profile

For end cabinets

Oil-resistant rubber mat



ORD. NO.

F UZ 3120 12 07

MDF top with rubber covering
No side profile

For additional central cabinets Oil-resist. rubber mat



ORD. NO.

F UZ 3120 13 07

MDF top with rubber covering
2 side profiles

For single cabinet

Oil-resistant rubber mat

CABINET PREPARED FOR WHEELS

Cabinet prepared for wheels including: wheel plate, 4 edged top with oil-resistant rubber, 2 steel handles covered with shock-resistant rubber, cylinder lock with 2 keys, anti-tilt rod.



The single drawer opening system **ORD. NO. F DD 9400 00 07** must be applied to all drawers of mobile cabinets.

01 02 04 08

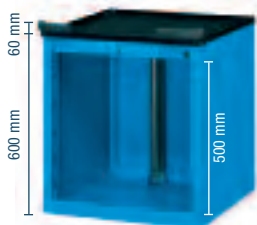

ORD. NO.

F DB 0550 00 04

Overall dimensions mm:
564x675x660 h
without wheels

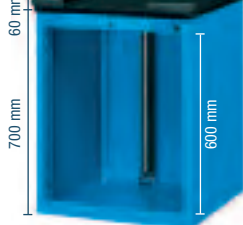

ORD. NO.

F DB 0560 00 04

Overall dimensions mm:
564x675x760 h
without wheels

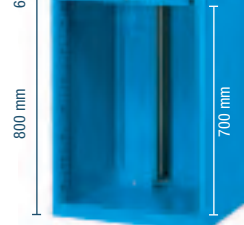

ORD. NO.

F DB 0570 00 04

Overall dimensions mm:
564x675x860 h
without wheels

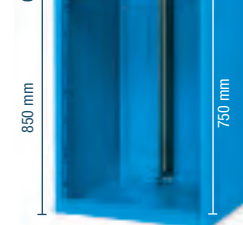

ORD. NO.

F DB 0575 00 04

Overall dimensions mm:
564x675x910 h
without wheels

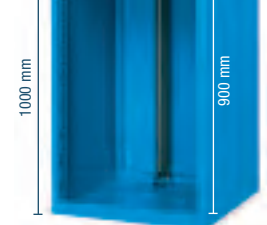

ORD. NO.

F DB 0590 00 04

Overall dimensions mm:
564x675x1060 h
without wheels



STANDARD RUBBER SWIVEL WHEEL WITH BRAKE

ORD. NO.	Ø mm	CABINET LOAD CAPACITY	C mm
C RG DAC11 100	100	160 kg	130
C RG DAC12 125	125	235 kg	160
C RG DAC13 150	150	280 kg	185



STANDARD RUBBER FIXED WHEEL

ORD. NO.	Ø mm	CABINET LOAD CAPACITY	C mm
C RG BAC11 100	100	160 kg	130
C RG BAC12 125	125	235 kg	160
C RG BAC13 150	150	280 kg	185



NYLON SWIVEL WHEEL WITH BRAKE

ORD. NO.	Ø mm	CABINET LOAD CAPACITY	C mm
C RN DAD10 100	100	310 kg	130
C RN DAD11 125	125	400 kg	160



NYLON FIXED WHEEL

ORD. NO.	Ø mm	CABINET LOAD CAPACITY	C mm
C RN BAD10 100	100	310 kg	130
C RN BAD11 125	125	400 kg	160

RAL 7000 F.01 RAL 6011 F.02 RAL 5012 F.04 RAL 7035 F.08

KEY

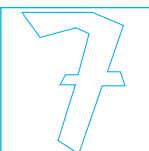

Other types of wheels: see page A52

The handles can be fitted towards the bottom thereby reducing the height by 38 mm.



All indicated loads are net and refer to evenly distributed weights.



LENGTH = 564 mm DEPTH = 600 mm (27x27 Eh)

CABINETS SERIES FLEXA

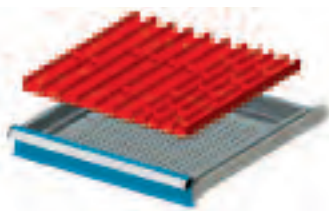

ORD. NO.	FOR FRONT HEIGHTS
----------	-------------------

F FH 8405 02 00	50-300
Set including:	
3 Troughs	4 grooves
6 Troughs	3 grooves
16 Plain partitions	36 mm
7 Plain partitions	47 mm

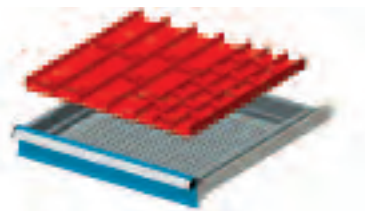

ORD. NO.	FOR FRONT HEIGHTS
----------	-------------------

F FH 8405 03 00	50-300
Set including:	
3 Troughs	3 grooves
6 Troughs	2 grooves
15 Plain partitions	47 mm
8 Plain partitions	73 mm

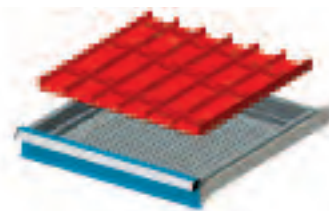

ORD. NO.	FOR FRONT HEIGHTS
----------	-------------------

F FH 8405 04 00	50-300
Set including:	
9 Troughs	2 grooves
18 Plain partitions	73 mm

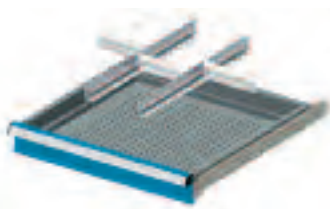

ORD. NO.	FOR FRONT HEIGHTS
----------	-------------------

F FH 8405 08 00	50
F FH 8407 08 00	75
F FH 8410 08 00	100-125
F FH 8415 08 00	150-175
F FH 8420 08 00	200-250
F FH 8430 08 00	300
Set including:	
2 Slotted partitions	455 mm
3 Plain partitions	149 mm

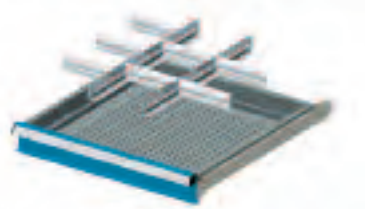

ORD. NO.	FOR FRONT HEIGHTS
----------	-------------------

F FH 8405 09 00	50
F FH 8407 09 00	75
F FH 8410 09 00	100-125
F FH 8415 09 00	150-175
F FH 8420 09 00	200-250
Set including:	
2 Slotted partitions	455 mm
7 Plain partitions	149 mm

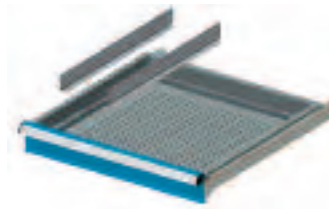

ORD. NO.	FOR FRONT HEIGHTS
----------	-------------------

F FH 8405 13 00	50
F FH 8407 13 00	75
F FH 8410 13 00	100-125
F FH 8415 13 00	150-175
F FH 8420 13 00	200-250
Set including:	
2 Plain partitions	455 mm

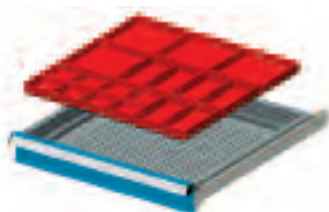

ORD. NO.	FOR FRONT HEIGHTS
----------	-------------------

F FH 8405 17 00	50
F FH 8407 17 00	75
Set including:	
8 Plastic boxes	75x75 mm
6 Plastic boxes	150x75 mm
4 Plastic boxes	150x150 mm

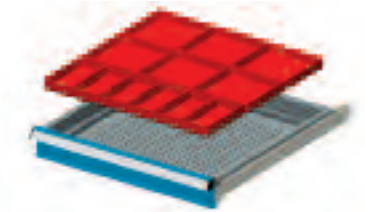

ORD. NO.	FOR FRONT HEIGHTS
----------	-------------------

F FH 8405 18 00	50
F FH 8407 18 00	75
F FH 8410 18 00	100-125
Set including:	
6 Plastic boxes	150x75 mm
6 Plastic boxes	150x150 mm

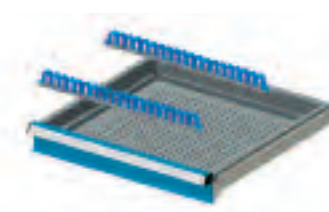

ORD. NO.	FOR FRONT HEIGHTS
----------	-------------------

F FH 8605 19 00	50-300
Set including:	
2 Multi-purpose supports	440 mm

■ INFO

www.famispa.com

■ Partitioning material: see page A180



CABINETS SERIES FLEXA

LENGTH = 717 mm DEPTH = 600 mm (36x27 Eh)



ORD. NO. F DF B560 05 56
RAL 7035+7000



ORD. NO. F DF 1090 61 08
RAL 7035

36 EH (600 mm)

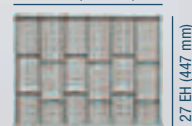

27 EH (447 mm)

FIXING SET



2x

- 2 "HILTI" plugs for concrete floors \geq to classes B25/RBK250/MP_A 25 N/mm²
- Recommended traction of the plug: 2.9 KN
- Plug diameter: \varnothing 6 mm

ORD. NO. F AG 9204 00 99

CABINET WITH WHEELS

ORD. NO. _____ **DRAWERS** _____

F DF B560 05 56 **3**

Complete with 3 drawers,
1 adjustable shelf, 1 flap door

Dimensions mm 792x600x920 h

Boxes, tools and partitioning material excluded

CABINET

ORD. NO. _____ **DRAWERS** _____

F DF 1090 61 08 **4**

Complete with 4 drawers, 1 electric system,
1 pneumatic system, 1 flap door,
1 rubber cover top with 4 edges

Dimensioni mm 717x600x1000 h

RAL 7000 F.01

RAL 6011 F.02

RAL 5012 F.04

RAL 7035 F.08

SUPPLEMENTARY PARTS ■



- Partitioning material: see page A29



- **Spare key.** Always indicate the number on the cylinder lock of the key to be replaced.

ORD. NO. R CSC 0002 00

- **Master key.** This type of key opens all the 45 and 46 series locks.

ORD. NO. R CSC 0001 00



LENGTH = 717 mm DEPTH = 600 mm (36x27 Eh)

CABINETS SERIES FLEXA

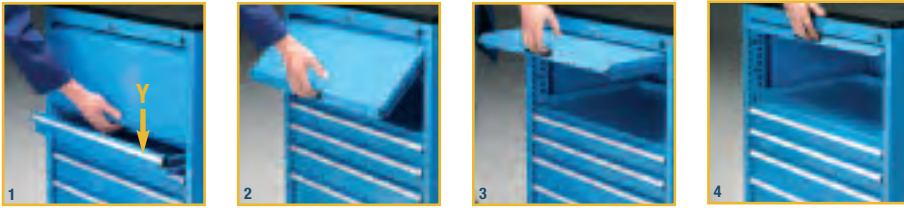

■ The door can be closed by the edge of the lower drawer handle (ref. Y)



ORD. NO.	DRAWERS
F DG 1030 51 04	2
Cabinet with 2 full extension drawers	
Dim. mm 717x600x400 h	
	Side lock



ORD. NO.	DRAWERS
F DG 1030 52 04	2
Cabinet with 2 full extension drawers	
Dim. mm 717x600x400 h	
	Side lock



ORD. NO.	DRAWERS
F DG 1030 53 04	3
Cabinet with 3 full extension drawers	
Dim. mm 717x600x400 h	
	Side lock

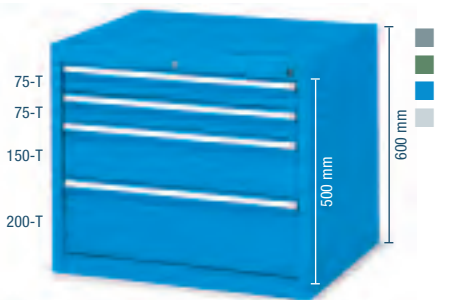

ORD. NO.	DRAWERS
F DF 1050 52 04	4
Cabinet with 4 full extension drawers	
Dim. mm 717x600x600 h	
	Central lock



ORD. NO.	DRAWERS
F DF 1050 56 04	3
Cabinet with 3 full extension drawers, 1 differential circuit breaker, 2 Schuko sockets 1 CEE 220-250V socket, 1 CEE 380V socket 1 pneumatic system with 2 outlets (excl. quick connectors)	
Dim. mm 717x600x600 h	
	Central lock

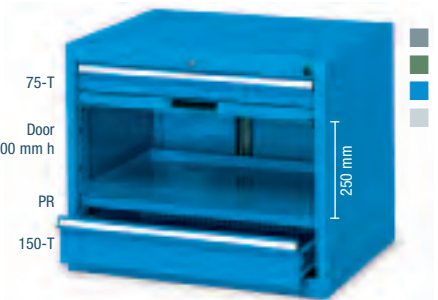

ORD. NO.	DRAWERS
F DF 1050 57 04	2
Cabinet with 2 full extension drawers, 1 adjustable shelf, 1 flap door	
Dimensions mm 717x600x600 h	
	Central lock



ORD. NO.	DRAWERS
F DF 1060 51 04	4
Cabinet with 4 full extension drawers	
Dim. mm 717x600x700 h	
	Central lock



ORD. NO.	DRAWERS
F DF 1060 54 04	3
Cabinet with 3 full extension drawers, 1 adjustable shelf, 1 flap door	
Dim. mm 717x600x700 h	
	Central lock

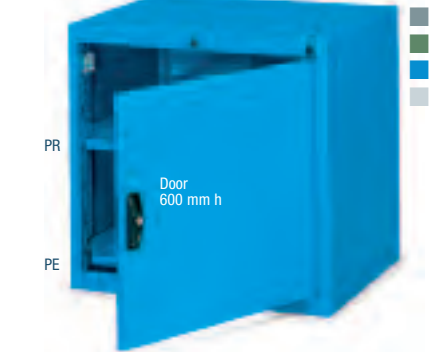

ORD. NO.	SHELVES
F DF 1060 57 04	2
Cabinet with 1 adjustable shelf, 1 retractable shelf 100%	
Dimensions mm 717x600x700 h	

■ KEY



- The cabinets must be secured to the floor or to the wall.
- PE = full extension retractable shelf (100%)
- PR = height adjustable shelf
- T = full extension (100%)

- RAL 7000 F.01
- RAL 6011 F.02
- RAL 5012 F.04
- RAL 7035 F.08



■ Detail of the full retractable shelves (PE) with load capacity of 70 kg.

■ Partitioning material: see page A29

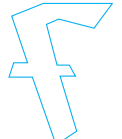

CABINETS SERIES FLEXA



ORD. NO.	DRAWERS
F DF 1070 52 04	5
Cabinet with 5 full extension drawers	
Dimensions mm 717x600x800 h	
Central lock	



ORD. NO.	DRAWERS
F DF 1070 54 04	4
Cabinet with 4 full extension drawers, 1 adjustable shelf, 1 flap door	
Dimensions mm 717x600x800 h	
Central lock	

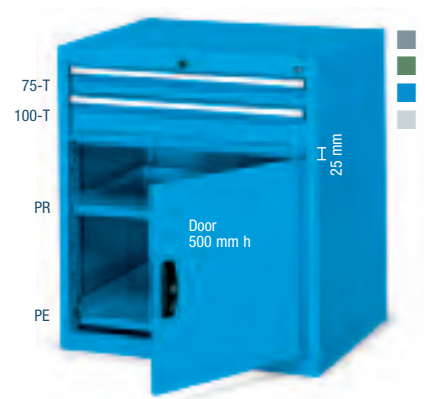

ORD. NO.	DRAWERS
F DG 1070 57 04	2
Cabinet with 2 full extension drawers 1 adjustable shelf, 1 retractable shelf 100%	
Dimensions mm 717x600x800 h	
Side lock	



ORD. NO.	DRAWERS
F DF 1070 59 04	5
Cabinet with 5 full extension drawers 1 differential circuit breaker 2 Schuko sockets 1 CEE 220-250V socket 1 CEE 380V socket 1 pneumatic system with 2 outlets (excluding quick connectors)	
Dimensions mm 717x600x800 h	
Central lock	



ORD. NO.	DRAWERS
F DF 1075 53 04	6
Cabinet with 6 full extension drawers	
Dimensions mm 717x600x850 h	
Central lock	

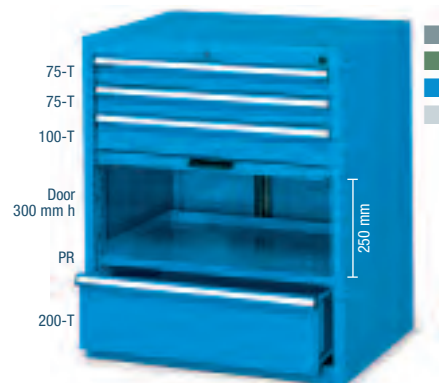

ORD. NO.	DRAWERS
F DF 1075 55 04	4
Cabinet with 4 full extension drawers, 1 adjustable shelf, 1 flap door	
Dimensions mm 717x600x850 h	
Central lock	

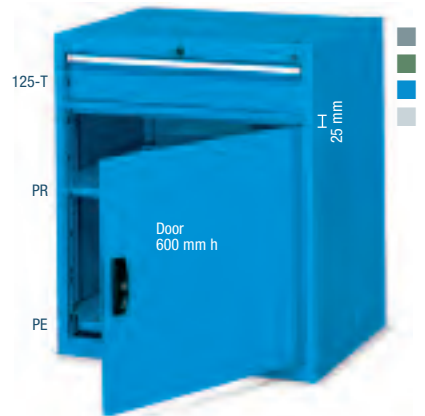

ORD. NO.	DRAWERS
F DG 1075 57 04	1
Cabinet with 1 full extension drawer 1 adjustable shelf, 1 retractable shelf 100%	
Dimensions mm 717x600x850 h	
Side lock	

RAL 7000 F.01

RAL 6011 F.02

RAL 5012 F.04

RAL 7035 F.08

KEY



■ Partitioning material: see page A29

■ Detail of the full retractable shelves (PE) with load capacity of 70 kg.



- The cabinets must be secured to the floor or to the wall.
- PE = full extension retractable shelf (100%)
- PR = height adjustable shelf
- T = full extension (100%)



LENGTH = 717 mm DEPTH = 600 mm (36x27 Eh)

CABINETS SERIES FLEXA



ORD. NO. DRAWERS
F DF 1090 52 04 6
 Cabinet with 6 full extension drawers
 Dim. mm 717x600x1000 h Central lock



ORD. NO. DRAWERS
F DF 1090 54 04 7
 Cabinet with 7 full extension drawers
 Dim. mm 717x600x1000 h Central lock



ORD. NO. DRAWERS
F DF 1090 55 04 8
 Cabinet with 8 full extension drawers
 Dim. mm 717x600x1000 h Central lock



ORD. NO. DRAWERS
F DF 1090 56 04 9
 Cabinet with 9 full extension drawers
 Dimensions mm 717x600x1000 h
 Central lock



ORD. NO. DRAWERS
F DF 1090 57 04 5
 Cabinet with 5 full extension drawers,
 1 adjustable shelf, 1 flap door
 Dim. mm 717x600x1000 h Central lock

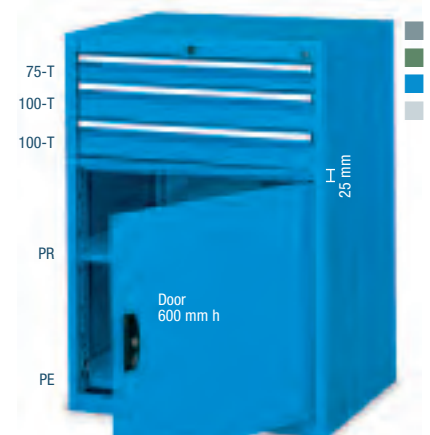

ORD. NO. DRAWERS
F DG 1090 59 04 3
 Cabinet with 3 full extension drawers
 1 adjustable shelf, 1 retractable shelf 100%
 Dim. mm 717x600x1000 h Side lock



ORD. NO. DRAWERS
F DF D550 01 04 4
 Cabinet with 4 full extension drawers
 Ø 100 mm standard rubber wheels
 Cabinet load capacity: 100 kg
 Dim. mm 792x600x790 h Central lock



ORD. NO. DRAWERS
F DF B550 02 04 5
 Cabinet with 5 full extension drawers
 Ø 125 mm standard rubber wheels
 Cabinet load capacity: 225 kg
 Dim. mm 792x600x820 h Central lock



ORD. NO. DRAWERS
F DF B550 04 04 2
 Cabinet with 2 full extension drawers
 Ø 125 mm standard rubber wheels
 1 flap door, 1 adjustable shelf
 Cabinet load capacity: 225 kg
 Dim. mm 792x600x820 h Central lock

KEY



- The cabinets must be secured to the floor or to the wall.
- PE = full extension retractable shelf (100%)
- PR = height adjustable shelf
- T = full extension (100%)
- All indicated loads are net and refer to evenly distributed weights.



■ The handles can be fitted towards the bottom thereby reducing the height by 38 mm.

■ Partitioning material: see page A29

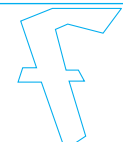

RAL 7000 F... ..01 RAL 6011 F... ..02 RAL 5012 F... ..04 RAL 7035 F... ..08

CABINETS SERIES FLEXA



ORD. NO.

DRAWERS

F DF D560 02 04**5**

Cabinet with 5 full extension drawers

Ø 100 mm standard rubber wheels

Cabinet load capacity: 100 kg

Dimensions mm 792x660x890 h

Central lock



ORD. NO.

DRAWERS

F DF B560 02 04**5**

Cabinet with 5 full extension drawers

Ø 125 mm standard rubber wheels

Cabinet load capacity: 225 kg

Dimensions mm 792x600x920 h

Central lock



ORD. NO.

DRAWERS

F DF B560 05 04**3**

Cabinet with 3 full extension drawers

Ø 125 mm standard rubber wheels

1 flap door, 1 adjustable shelf

Cabinet load capacity: 225 kg

Dim. mm 792x600x920 h

Central lock



ORD. NO.

DRAWERS

F DF B560 06 04**2**

Cabinet with 2 full extension drawers, 1 differential circuit breaker, 1 Schuko socket, 1 electric rear winder 220V for the connection to the electric main supply, 1 pneumatic system with 1 3/8" fixed frontal outlet (excluding quick connection), 1 frontal pneumatic winder with hose Ø 5,5 mm and connector of 1/4", 1 rear pneumatic winder with hose Ø 10 mm and connector of 3/8" for the connection to the pneumatic system.

Ø 125 mm standard rubber wheels, cabinet load capacity: 225 kg

Dimensions mm 792x600x920 h Central lock

Usable power:

1200 Watt with wound cable,**1800 Watt with cable completely unwound.**Rear 11 metres long pneumatic extension.
Rear 10 metres long electric extension.

ORD. NO.

DRAWERS

F DF B561 01 04**5**Cabinet with 5 full extension drawers,
4 practibox drawer unit ORD. NO. F PG 2071 01 01

Ø 125 mm standard rubber wheels

Cabinet load capacity: 225 kg

Dimensions mm 1072x600x885 h**Multiplex worktop dim. mm 860x600x25 h**

Central lock



ORD. NO.

DRAWERS

F DF B570 02 04**6**

Cabinet with 6 full extension drawers

Ø 125 mm standard rubber wheels

Cabinet load capacity: 225 kg

Dimensions mm 792x600x1020 h

Central lock



ORD. NO.

DRAWERS

F DF B570 04 04**4**Cabinet with 4 full extension drawers,
1 flap door, 1 adjustable shelf

Ø 125 mm standard rubber wheels

Cabinet load capacity: 225 kg

Dim. mm 792x600x1020 h

Central lock

RAL 7000 F.01

RAL 6011 F.02

RAL 5012 F.04

RAL 7035 F.08

KEY ■

- PR = height adjustable shelf
- T = full extension (100%)
- All indicated loads are net and refer to evenly distributed weights.



Detail of the 4 PRACTIBOX drawer units (ORD. NO. F PG 2071 01 01) fixed on the left-hand side of the cabinet ORD. NO. F DF B561 01 04. These practibox drawer units are supplied with retaining bars.



LENGTH = 717 mm DEPTH = 600 mm (36x27 Eh)

CABINETS SERIES FLEXA

CABINET WITH WHEELS

ORD. NO.

F DF B570 S1 FN

Complete with 4 drawers

1 adjustable shelf

1 flap door

Dimensions mm 794x600x982 h

Boxes, tools and partitioning material excluded



■ RAL 3020 +
■ RAL 9011



■ RAL 7035

EXAMPLE INCLUDING:

ORD. NO.

F DF 1070 61 08

Cabinet complete with 1 drawer

1 door

1 retractable shelf

1 electric system

1 pneumatic system

1 pair of plinths

1 upper MDF top with rubber

Dimensions mm 717x600x960 h

Tools and partitioning material excluded

■ INFO

RAL 7000 F.01

RAL 6011 F.02

RAL 5012 F.04

RAL 7035 F.08

■ Partitioning material: see page A180

www.famispa.com

CABINETS SERIES FLEXA

EMPTY CABINETS

ORD. NO.	USABLE HEIGHT mm	LOAD CAPACITY kg	DIMENSIONS mm
F DG 1030 00 04	300	400	717x600x400 h
F DF 1050 00 04	500	900	717x600x600 h
F DF 1060 00 04	600	900	717x600x700 h
F DF 1070 00 04	700	900	717x600x800 h
F DF 1075 00 04	750	900	717x600x850 h
F DF 1090 00 04	900	900	717x600x1000 h

01 02 04 08



- Cabinets series F DF: central lock with anti-tilt rod.
- Cabinets series F DG: side lock with side rod.
- Worktop load capacity: 80 kg

■ The cabinets must be secured to the floor or to the wall. If the cabinets are stacked they must be secured to the wall and their load capacity must be divided by 2. Further information for fixing set see page A20.

■ Drawers cannot be fitted behind doors.

DRAWERS



01 02 04 08

■ The single drawer opening system ORD. NO. F DD 9400 00 07 must be applied to all drawers of mobile cabinets.

ORD. NO.	FRONT HEIGHT mm	LOAD CAPACITY kg	USABLE DIMENSIONS mm
F DF 8075 00 04	75	70	600x447x61 h
F DF 8100 00 04	100	70	600x447x86 h
F DF 8125 00 04	125	70	600x447x111 h
F DF 8150 00 04	150	70	600x447x136 h
F DF 8175 00 04	175	70	600x447x161 h
F DF 8200 00 04	200	70	600x447x186 h
F DF 8300 00 04	300	70	600x447x286 h

Full extension (100%)

SPARE LOCK AND SPARE HANDLE

ORD. NO.

R CSR 0003 00
Spare lock (for central lock)

R CSR 0032 00
Spare lock (for side lock)

R CSR 0033 00
Spare lock (for doors handle)

R XDA 0002 07
Spare handle (for doors)

- Partitioning material: see page A29



RETRACTABLE SHELVES

ORD. NO.	USABLE DIMENSIONS mm
F DF 8000 00 04	587x475

Side height: -
Load capacity kg: 70 Full extension (100%)



01 02 04

ADJUSTABLE SHELVES

ORD. NO.	USABLE DIMENSIONS mm
F DF 9100 01 04	655x460

Side height: 25 mm
Load capacity kg: 70 Without extension system



01 02 04

PAIR OF PLINTHS

ORD. NO.	HEIGHT mm
F RR 1608 00 07	130



07

TOP WITH 4 EDGES

ORD. NO.	DIMENSIONS mm
F DF 9940 01 07	717x600x22 h

Top with 4 edges in rubber
Oil-resistant rubber mat



07

PARTIAL HEIGHT REVERSIBLE DOOR



- The door can be fitted both with left-hand and right-hand opening.

ORD. NO.	HEIGHT (A) mm
F DF 9640 02 04	400+25
F DF 9645 02 04	500+25
F DF 9650 02 04	600+25

TOTAL HEIGHT REVERSIBLE DOOR



- The door can be fitted both with left-hand and right-hand opening.

ORD. NO.	HEIGHT (A) mm
F DF 9645 01 04	500
F DF 9650 01 04	600

01 02 04 08

- Drawers cannot be fitted behind doors



99
CATCH
ORD. NO.
F DA 9698 00 99
To order with full height doors only.

LENGTH = 717 mm DEPTH = 600 mm (36x27 Eh)

CABINETS SERIES FLEXA

UPPER MDF TOP WITH RUBBER COVERING DIMENSIONS 718x600x31,5 mm H

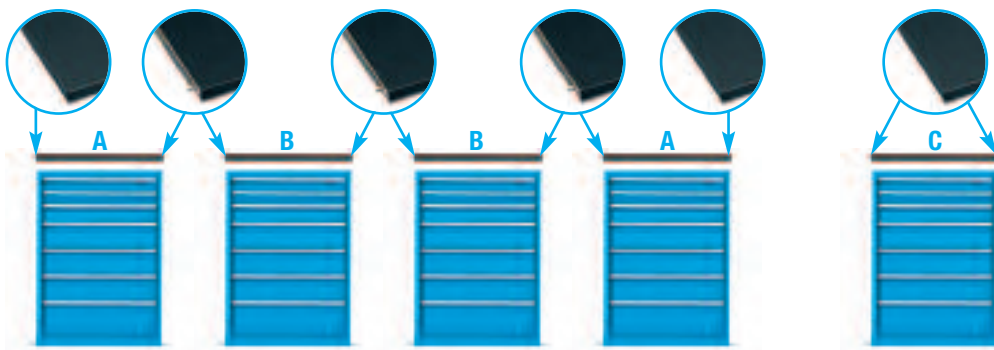

Detail of the oil-resistant rubber

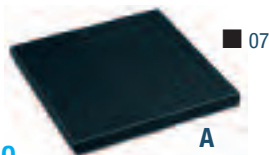

07

A

ORD. NO.

F UZ 3130 11 07

MDF top with rubber covering

Side profile

For end cabinets

Oil-resistant rubber mat



07

B

ORD. NO.

F UZ 3130 12 07

MDF top with rubber covering

No side profile

For additional central cabinets Oil-resist. rubber mat

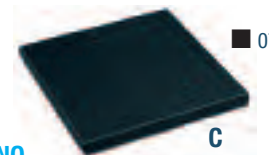

07

C

ORD. NO.

F UZ 3130 13 07

MDF top with rubber covering

2 side profiles

For single cabinet

Oil-resistant rubber mat

CABINET PREPARED FOR WHEELS

Cabinet prepared for wheels including: wheel plate, 4 edged top with oil-resistant rubber, 2 steel handles covered with shock-resistant rubber, cylinder lock with 2 keys, anti-tilt rod.



The single drawer opening system ORD. NO. F DD 9400 00 07 must be applied to all drawers of mobile cabinets.



Detail of the 4 edged top with side handle. Further information see catalogue no. 400.

01 02 04 08

Complete of 4 Practibox drawer units ORD. NO. F PG 2071 01 01, multiplex worktop and side handle.

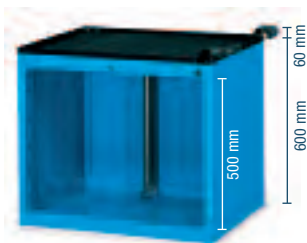

ORD. NO.

F DF 0550 00 04

Overall dimensions mm:
792x600x660 h without wheels



ORD. NO.

F DF 0560 00 04

Overall dimensions mm:
792x600x760 h without wheels

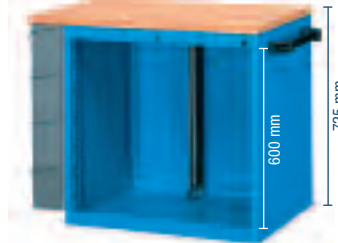

ORD. NO.

F DF 0561 00 04

Overall dimensions mm:
1072x600x725 h without wheels
Multiplex worktop dim. mm: 860x600x25 h

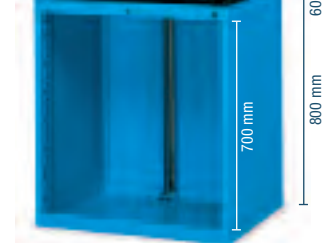

ORD. NO.

F DF 0570 00 04

Overall dimensions mm:
792x600x860 h without wheels



STANDARD RUBBER SWIVEL WHEEL WITH BRAKE

ORD. NO.

ORD. NO.	Ø mm	CABINET LOAD CAPACITY	C mm
C RG DAC11 100	100	150 kg	130
C RG DAC12 125	125	225 kg	160
C RG DAC13 150	150	270 kg	185



NYLON SWIVEL WHEEL WITH BRAKE

ORD. NO.

ORD. NO.	Ø mm	CABINET LOAD CAPACITY	C mm
C RN DAD10 100	100	270 kg	130
C RN DAD11 125	125	270 kg	160

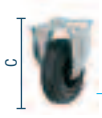

STANDARD RUBBER FIXED WHEEL

ORD. NO.

ORD. NO.	Ø mm	CABINET LOAD CAPACITY	C mm
C RG BAC11 100	100	150 kg	130
C RG BAC12 125	125	225 kg	160
C RG BAC13 150	150	270 kg	185



NYLON FIXED WHEEL

ORD. NO.

ORD. NO.	Ø mm	CABINET LOAD CAPACITY	C mm
C RN BAD10 100	100	270 kg	130
C RN BAD11 125	125	270 kg	160

KEY

RAL 7000 F.01 RAL 6011 F.02 RAL 5012 F.04 RAL 7035 F.08



All indicated loads are net and refer to evenly distributed weights.



The handles can be fitted towards the bottom thereby reducing the height by 38 mm.

Other types of wheels: see page A52



CABINETS SERIES FLEXA

FLAP DOOR

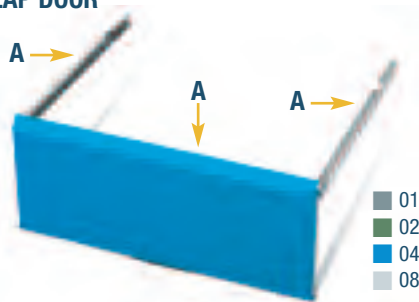

ORD. NO.	REFERENCE
F DF 9615 00 04	A+(Cx2)

Flap door with 2 guides and 2 brackets to block the door with the lower drawer locked.

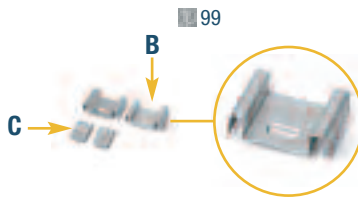

ORD. NO.	REFERENCE
F DA 9698 00 99	B

The order number includes just 1 piece. 2 pieces are needed for each door.

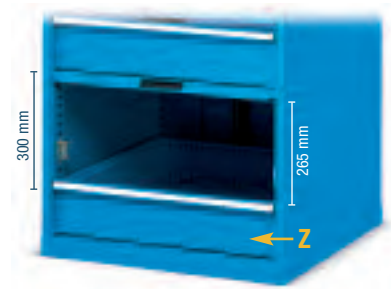

■ The two stops (ref. B) must be used when the door is fitted along with the drawer (ref. Z). See photo ref. 5 to understand the usable internal volume.

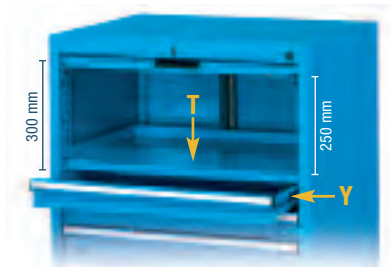

■ The two stops (ref. B) are not required when the door is fitted along with the adjustable shelf (ref. T) ORD. NO. F DF 9100 01 ..

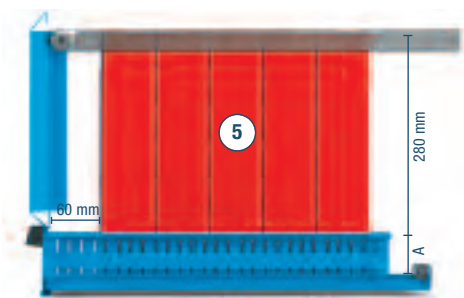

A = usable height of the drawer
Warning: the 60 mm distance from the drawer edge should be respected only if the door has to be closed with the two brackets (Ref. C)

RACK



ORD. NO.
C MV 99 126

Standard (600x150 mm) CD or DVD rack.
Warning: The rack is supplied with a length of 36 Eh (600 mm).

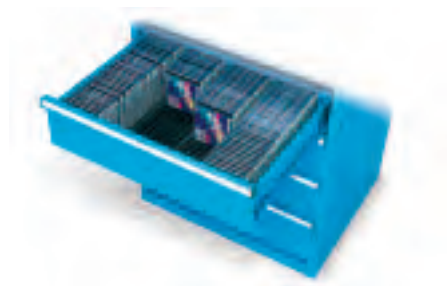

■ 120 standard CD or DVD cases (142x10x125 mm) can be stored into the 175 mm h drawer (with 4 ORD. NO. C MV 99 126 racks). The cases can be stored with their **spines facing upwards**. The racks are supplied with a length of 36 Eh (600 mm), therefore 9 Eh (153 mm) must be cut in order for them to fit into the drawer.

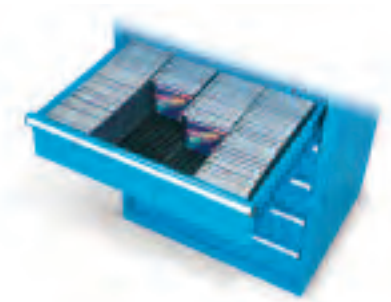

■ 120 standard CD or DVD cases (142x10x125 mm) can be stored into the 150 mm h drawer (with 4 ORD. NO. C MV 99 126 racks). The cases can be stored with their **spines facing sideways**. The racks are supplied with a length of 36 Eh (600 mm), therefore 9 Eh (153 mm) must be cut in order for them to fit into the drawer.

PERFORATED BACK PANELS

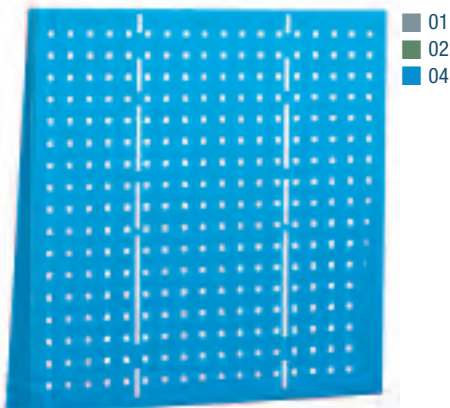

ORD. NO.	DIMENSIONS mm
F DF 7942 00 04	717x93x420 h
F DF 7970 00 04	717x93x700 h



■ Hooks see page C66

■ This type of panel can be applied with an MDF top (see page A27) or with a multiplex worktop.

LENGTH = 717 mm DEPTH = 600 mm (36x27 Eh)

CABINETS SERIES FLEXA

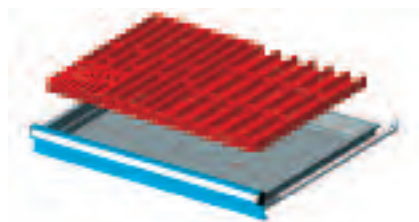

ORD. NO.	FOR FRONT HEIGHTS
F FH 1005 15 00	50-300
Set including:	
5 Troughs	4 grooves
20 Plain partitions	36 mm
6 Troughs	3 grooves
20 Plain partitions	47 mm
1 Allen key tray	150x150 mm

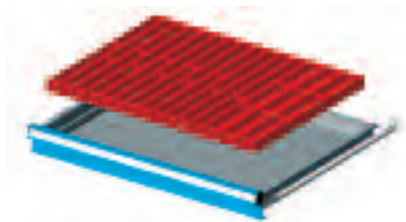

ORD. NO.	FOR FRONT HEIGHTS
F FH 1005 10 00	50-300
Set including:	
9 Troughs	4 grooves
36 Plain partitions	36 mm
3 Troughs	3 grooves
12 Plain partitions	47 mm

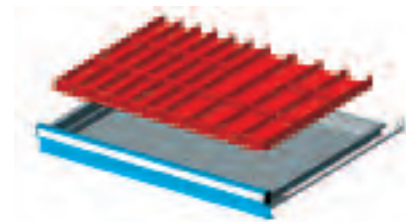

ORD. NO.	FOR FRONT HEIGHTS
F FH 1005 13 00	50-300
Set including:	
6 Troughs	3 grooves
18 Plain partitions	47 mm
6 Troughs	2 grooves
12 Plain partitions	73 mm

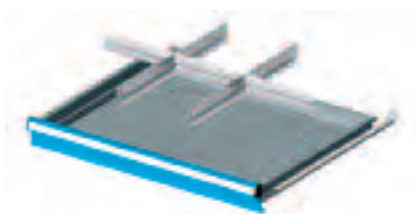

ORD. NO.	FOR FRONT HEIGHTS
F FH 1005 05 00	50
F FH 1007 05 00	75
F FH 1010 05 00	100-125
F FH 1015 05 00	150-175
F FH 1020 05 00	200-250
F FH 1030 05 00	300
Set including:	
2 Slotted partitions	455 mm
3 Plain partitions	200 mm



ORD. NO.	FOR FRONT HEIGHTS
F FH 1005 03 00	50
F FH 1007 03 00	75
F FH 1010 03 00	100-125
F FH 1015 03 00	150-175
F FH 1020 03 00	200-250
Set including:	
3 Slotted partitions	455 mm
8 Plain partitions	149 mm

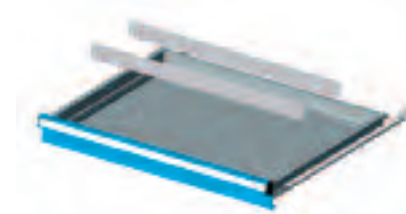

ORD. NO.	FOR FRONT HEIGHTS
F FH 1005 01 00	50
F FH 1007 01 00	75
F FH 1010 01 00	100-125
F FH 1015 01 00	150-175
F FH 1020 01 00	200-250
F FH 1030 01 00	300
Set including:	
2 Plain partitions	610 mm

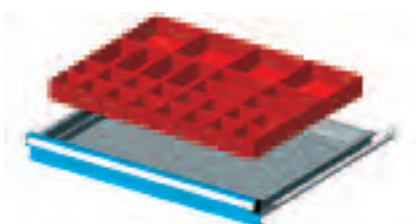

ORD. NO.	FOR FRONT HEIGHTS
F FH 1005 18 00	50
F FH 1007 18 00	75
Set including:	
16 Plastic boxes	75x75 mm
8 Plastic boxes	150x75 mm
4 Plastic boxes	150x150 mm

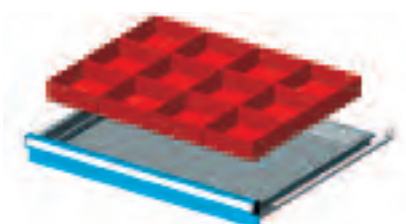

ORD. NO.	FOR FRONT HEIGHTS
F FH 1005 09 00	50
F FH 1007 09 00	75
F FH 1010 09 00	100-125
Set including:	
12 Plastic boxes	150x150 mm

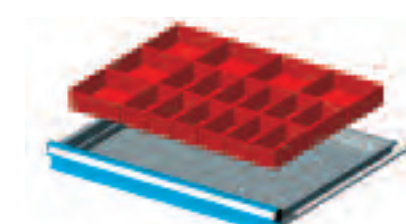

ORD. NO.	FOR FRONT HEIGHTS
F FH 1005 16 00	50
F FH 1007 16 00	75
F FH 1010 16 00	100-125
Set including:	
12 Plastic boxes	150x75 mm
6 Plastic boxes	150x150 mm

■ INFO

www.famispa.com

■ Partitioning material: see page A180



CABINETS SERIES FLEXA

LENGTH = 1023 mm DEPTH = 600 mm (54x27 Eh)



ORD. NO. F DL 1060 S1 77
RAL 5012+7035

ORD. NO. F DL 1090 S1 50
RAL 7035+5012



ORD. NO. F FH 4007 17 00
Partitioning material

FIXING SET



2x

- 2 "HILTI" plugs for concrete floors ≥ to classes B25/RBK250/MPA 25 N/mm²
- Recommended traction of the plug: 2.9 KN
- Plug diameter: Ø 6 mm

ORD. NO. F AG 9204 00 99

CABINET

ORD. NO.	DRAWERS
F DL 1060 S1 77	5

Complete with 5 drawers, 1 pair of plinths,
1 multi-purpose back panel with hooks and Practibox,
1 upper MDF top with rubber

Dimensions mm 1023x600x860/1560 h

Tools and partitioning material excluded

CABINET

ORD. NO.	DRAWERS
F DL 1090 S1 50	7

Complete with 7 drawers,
1 rubber cover top with 3 edges

Dimensions mm 1023x600x1000 h

RAL 7000 F.01 RAL 6011 F.02 RAL 5012 F.04 RAL 7035 F.08

SUPPLEMENTARY PARTS ■

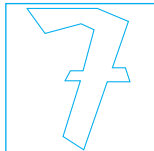

■ Partitioning material: see page A34



- **Spare key.** Always indicate the number on the cylinder lock of the key to be replaced.
ORD. NO. R CSC 0002 00
- **Master key.** This type of key opens all the 45 and 46 series locks.
ORD. NO. R CSC 0001 00



LENGTH = 1023 mm DEPTH = 600 mm (54x27 Eh)

CABINETS SERIES FLEXA



ORD. NO.

DRAWERS

F DL 1030 51 04

2

Cabinet with 2 full extension drawers

Dimensions mm 1023x600x400 h

Central lock



ORD. NO.

DRAWERS

F DL 1030 54 04

3

Cabinet with 3 full extension drawers

Dimensions mm 1023x600x400 h

Central lock



ORD. NO.

DRAWERS

F DL 1060 51 04

4

Cabinet with 4 full extension drawers

Dimensions mm 1023x600x700 h

Central lock



ORD. NO.

DRAWERS

F DL 1060 52 04

5

Cabinet with 5 full extension drawers

Dimensions mm 1023x600x700 h

Central lock

■ RAL 3020 +
■ RAL 9011



EXAMPLE INCLUDING:

ORD. NO.

F DL 1070 54 FN

Cabinet complete with 8 drawers

1 pair of plinths

1 upper MDF top with rubber

Dimensions mm 1023x600x960 h

Tools and partitioning material excluded

■ KEY

RAL 7000 F.01

RAL 6011 F.02

RAL 5012 F.04

RAL 7035 F.08

■ Partitioning material: see page A34

■ Partitioning material: see page A180



- The cabinets must be secured to the floor or to the wall.
- T = full extension (100%)



CABINETS SERIES FLEXA



ORD. NO.	DRAWERS
F DL 1070 51 04	4
Cabinet with 4 full extension drawers	
Dimensions mm 1023x600x800 h	
Central lock	



ORD. NO.	DRAWERS
F DL 1070 52 04	5
Cabinet with 5 full extension drawers	
Dimensions mm 1023x600x800 h	
Central lock	



ORD. NO.	DRAWERS
F DL 1090 54 04	7
Cabinet with 7 full extension drawers	
Dimensions mm 1023x600x1000 h	
Central lock	



ORD. NO.	DRAWERS
F DL 1090 55 04	8
Cabinet with 8 full extension drawers	
Dimensions mm 1023x600x1000 h	
Central lock	

RAL 7000 F.01 RAL 6011 F.02 RAL 5012 F.04 RAL 7035 F.08

KEY ■

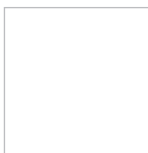
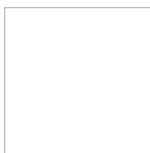
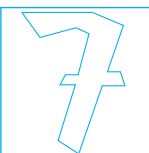

■ Partitioning material: see page A34

- The cabinets must be secured to the floor or to the wall.
- T = full extension (100%)



LENGTH = 1023 mm DEPTH = 600 mm (54x27 Eh)

CABINETS SERIES FLEXA

EMPTY CABINETS

ORD. NO.	USABLE HEIGHT mm	LOAD CAPACITY kg	DIMENSIONS mm
F DL 1030 00 04	300	400	1023x600x400 h
F DL 1060 00 04	600	900	1023x600x700 h
F DL 1070 00 04	700	900	1023x600x800 h
F DL 1090 00 04	900	900	1023x600x1000 h

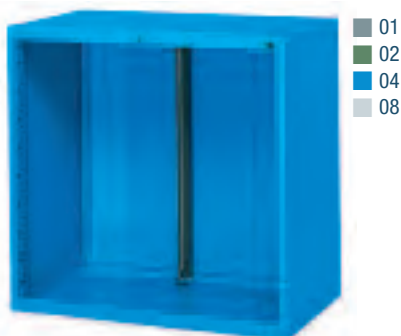

SPARE LOCK

ORD. NO. R CSR 0003 00
for central lock

■ The cabinets must be secured to the floor or to the wall. If the cabinets are stacked they must be secured to the wall and their load capacity must be divided by 2. Further information for fixing set see page A30.

■ Drawers cannot be fitted behind doors.

DRAWERS

ORD. NO.	FRONT HEIGHT mm	LOAD CAPACITY kg	USABLE DIMENSIONS mm
F DL 8075 00 04	75	50	906x447x61 h
F DL 8100 00 04	100	50	906x447x86 h
F DL 8150 00 04	150	50	906x447x136 h
F DL 8175 00 04	175	50	906x447x161 h
F DL 8200 00 04	200	50	906x447x186 h

Full extension (100%)

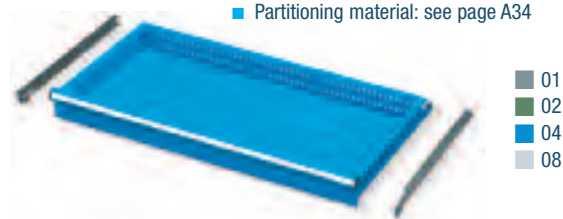

■ Partitioning material: see page A34

ADJUSTABLE SHELVES

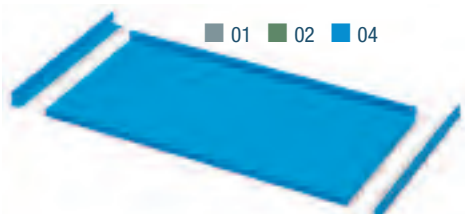

ORD. NO.	USABLE DIMENSIONS mm
F DL 9100 01 04	960x460

Side height: 25
Load capacity kg: 70 Without extension system

TOP



ORD. NO.	DIMENSIONS mm
F DL 9150 01 07	1023x600x20 h

Rubber cover top with 3 edges
Oil-resistant rubber mat

PAIR OF PLINTHS



ORD. NO.	HEIGHT mm
F RR 1608 00 07	130

PERFORATED BACK PANELS

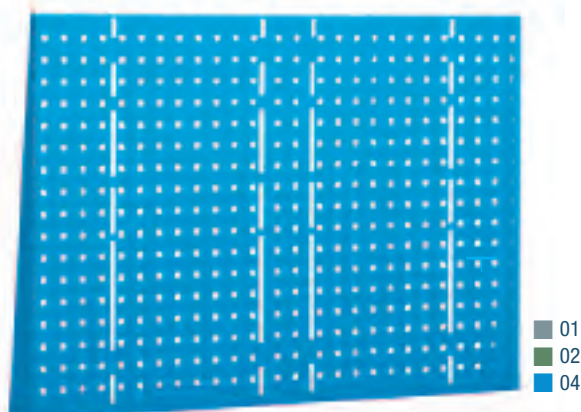

ORD. NO.	DIMENSIONS mm
F DL 7942 00 04	1016x93x420 h
F DL 7970 00 04	1016x93x700 h



■ Hooks see page C66

■ This type of panel can be applied with an MDF top (see page A35) or with a multiplex worktop (see page A36).

LENGTH = 1023 mm DEPTH = 600 mm (54x27 Eh)

CABINETS SERIES FLEXA

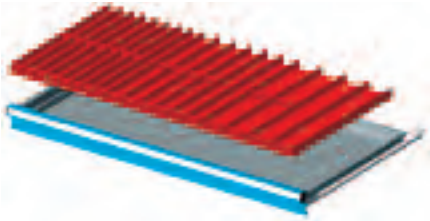

ORD. NO.	FOR FRONT HEIGHTS
----------	-------------------

F FH 4005 12 00	50-300
Set including:	
6 Troughs	4 grooves
15 Plain partitions	36 mm
6 Troughs	3 grooves
10 Plain partitions	47 mm
6 Troughs	2 grooves
6 Plain partitions	73 mm

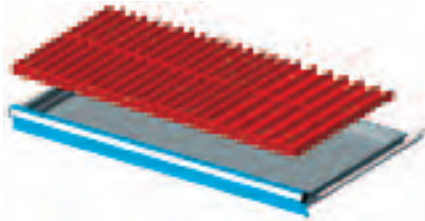

ORD. NO.	FOR FRONT HEIGHTS
----------	-------------------

F FH 4005 15 00	50-300
Set including:	
12 Troughs	4 grooves
30 Plain partitions	36 mm
6 Troughs	3 grooves
10 Plain partitions	47 mm

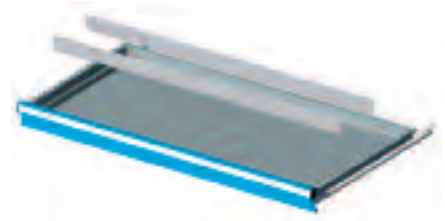

ORD. NO.	FOR FRONT HEIGHTS
----------	-------------------

F FH 4005 01 00	50
F FH 4007 01 00	75
F FH 4010 01 00	100-125
F FH 4015 01 00	150-175
F FH 4020 01 00	200-250
F FH 4030 01 00	300
Set including:	
2 Plain partitions	914 mm



ORD. NO.	FOR FRONT HEIGHTS
----------	-------------------

F FH 4005 03 00	50
F FH 4007 03 00	75
F FH 4010 03 00	100-125
F FH 4015 03 00	150-175
F FH 4020 03 00	200-250
Set including:	
5 Slotted partitions	455 mm
12 Plain partitions	149 mm

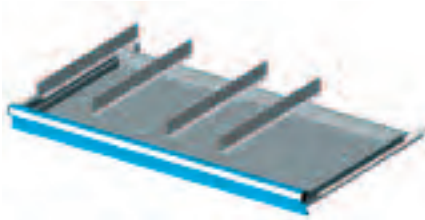

ORD. NO.	FOR FRONT HEIGHTS
----------	-------------------

F FH 4005 04 00	50
F FH 4007 04 00	75
F FH 4010 04 00	100-125
F FH 4015 04 00	150-175
F FH 4020 04 00	200-250
Set including:	
4 Plain partitions	455 mm

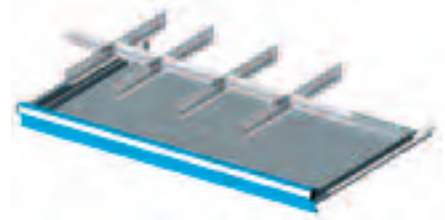

ORD. NO.	FOR FRONT HEIGHTS
----------	-------------------

F FH 4005 05 00	50
F FH 4007 05 00	75
F FH 4010 05 00	100-125
F FH 4015 05 00	150-175
F FH 4020 05 00	200-250
Set including:	
4 Slotted partitions	455 mm
2 Plain partitions	149 mm
3 Plain partitions	200 mm

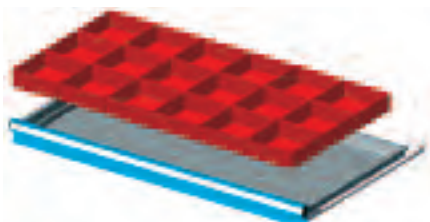

ORD. NO.	FOR FRONT HEIGHTS
----------	-------------------

F FH 4005 11 00	50
F FH 4007 11 00	75
F FH 4010 11 00	100-125
Set including:	
18 Plastic boxes	150x150 mm

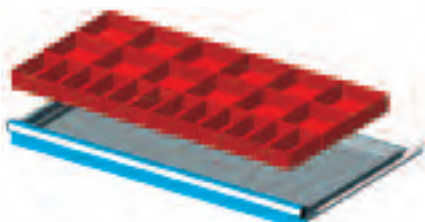

ORD. NO.	FOR FRONT HEIGHTS
----------	-------------------

F FH 4005 13 00	50
F FH 4007 13 00	75
F FH 4010 13 00	100-125
Set including:	
12 Plastic boxes	150x75 mm
12 Plastic boxes	150x150 mm

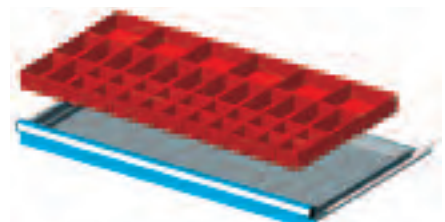

ORD. NO.	FOR FRONT HEIGHTS
----------	-------------------

F FH 4005 16 00	50
F FH 4007 16 00	75
Set including:	
20 Plastic boxes	75x75 mm
14 Plastic boxes	150x75 mm
6 Plastic boxes	150x150 mm

INFO ■

■ Partitioning material: see page **A180**

www.famispa.com



LENGTH = 1023 mm DEPTH = 600 mm (54x27 Eh)

CABINETS SERIES FLEXA

UPPER MDF TOP WITH RUBBER COVERING DIMENSIONS 1024x600x31,5 mm H

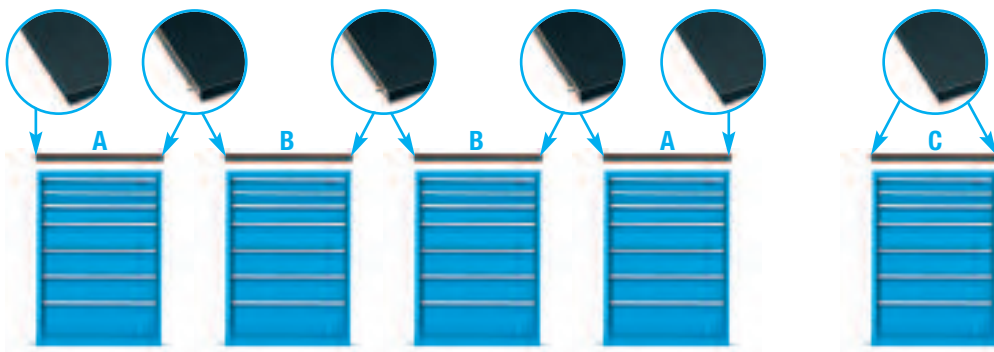

Detail of the oil-resistant rubber

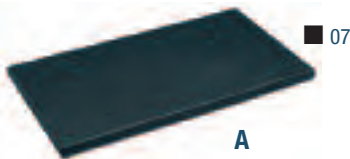

A



B



C

ORD. NO.

F UZ 3140 11 07

MDF top with rubber covering

Side profile

For end cabinets

Oil-resistant rubber mat

ORD. NO.

F UZ 3140 12 07

MDF top with rubber covering

No side profile

For additional central cabinets Oil-resist. rubber mat

ORD. NO.

F UZ 3140 13 07

MDF top with rubber covering

2 side profiles

For single cabinet

Oil-resistant rubber mat



ORD. NO.

DRAWERS

F DL 1090 51 04

5

Cabinet with 5 full extension drawers

Dimensions mm 1023x600x1000 h

Central lock

■ 180 standard CD or DVD cases (142x10x125 mm) can be stored into the 175 mm h drawer (with 6 ORD. NO. C MV 99 126 racks). The cases can be stored with their **spines facing upwards**.

The racks are supplied with a length of 36 Eh (600 mm), therefore 9 Eh (153 mm) must be cut in order for them to fit into the drawer.

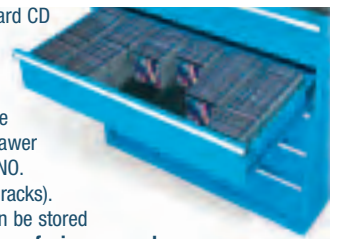

■ 180 standard CD or DVD cases (142x10x125 mm) can be stored into the 150 mm h drawer (with 6 ORD. NO. C MV 99 126 racks). The cases can be stored with their **spines facing sideways**.

The racks are supplied with a length of 36 Eh (600 mm), therefore 9 Eh (153 mm) must be cut in order for them to fit into the drawer.



ORD. NO.

DRAWERS

F DL 1090 52 04

6

Cabinet with 6 full extension drawers

Dimensions mm 1023x600x1000 h

Central lock

RACK

ORD. NO.

C MV 99 126

Standard (600x150 mm) CD or DVD rack.

Warning: The rack is supplied with a length of 36 Eh (600 mm).



KEY

RAL 7000 F.01

RAL 6011 F.02

RAL 5012 F.04

RAL 7035 F.08



- The cabinets must be secured to the floor or to the wall.
- T = full extension (100%)

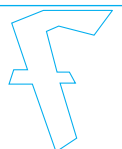

CABINETS SERIES FLEXA

**STORAGE CAPACITY WITH THE SPINES OF THE CASES (DIM. 142x10x125 mm)
LATERALLY POSITIONED: 5640 CD/DVD**

ORD. NO.**F DL ZA01 00 56**

Example including:

7 cabinets, 38 drawers, 188 CD/DVD racks

2 flap doors, 2 adjustable shelves, 3 PVC cover MDF tops

Dimensions mm 4202x600x1030/2000 h

Tools and CD/DVD excluded



RAL 7000 F.01

RAL 6011 F.02

RAL 5012 F.04

RAL 7035 F.08

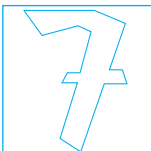
KEY ■

- The cabinets must be secured to the floor or to the wall.



LENGTH = 1023 mm DEPTH = 600 mm (54x27 Eh)

CABINETS SERIES FLEXA



■ RAL 7035 + ■ RAL 7000

■ KEY

RAL 7000 F.01
 RAL 6011 F.02
 RAL 5012 F.04
 RAL 7035 F.08



■ The cabinets must be secured to the floor or to the wall.



WORKSTATIONS SERIES FLEXA



ORD. NO. F CB H610 S1 50
RAL 7035+5012

ORD. NO.
F FH 1010 20 00

LOAD CAPACITY

- Workstation: 250 kg
- Drawer: 70 kg
- Adjustable shelf: 70 kg
- Retractable shelf: 70 kg
- 4 edged tray: 70 kg
- Worktop: 250 kg

MOBILE WORKSTATION

ORD. NO. _____ **DRAWERS** _____

F CB H610 S1 50 **4**

Complete with 4 drawers
1 electric system, 1 pneumatic system,
1 flap door, 1 door, 1 retractable shelf,
1 multi-purpose back panel with accessories

Dimensions mm 1227x700x915/1335 h

Tools excluded

PARTITIONING MATERIAL

ORD. NO. _____

F FH 1010 20 00

Partitioning material for drawers
ORD. NO. **F DF 8100 00 ..** (36x27 Eh height 100 mm)

RAL 7000 F.01

RAL 6011 F.02

RAL 5012 F.04

RAL 7035 F.08

KEY ■

■ Partitioning material: see page **A180**

■ Detail of the height adjustable shelves (PR) with load capacity of 70 kg.



■ All indicated loads are net and refer to evenly distributed weights.



MOBILE WORKSTATION INCLUDING 1 19 EH CABINET + 1 27 EH CABINET



■ RAL 7000



MOBILE WORKSTATION

ORD. NO.

F CB H440 S1 01

- 4 drawers
- 2 adjustable shelves
- 2 storage containers
- 2 tops with 4 edges

Dimensions mm 1070x600x907 h

Tools and partitioning material excluded

MOBILE WORKSTATION INCLUDING 1 27 EH CABINET + 1 27 EH CABINET



■ RAL 7035 + ■ RAL 7000



■ Vices can be fixed on the 30 mm thick worktops. See page C77 for further information.



MOBILE WORKSTATION

ORD. NO.

F CB H510 S1 56

- 2 doors
- 8 adjustable shelves
- 8 Tecno Store toolboxes with plastic boxes
- 2 retractable shelves
- 6 Multibox boxes

Dimensions mm 1227x700x915 h

Tools excluded

■ KEY

RAL 7000 F.01

RAL 6011 F.02

RAL 5012 F.04

RAL 7035 F.08



■ All indicated loads are net and refer to evenly distributed weights.



■ Detail of the height adjustable shelves (PR) with load capacity of 70 kg.

■ Partitioning material: see page A180

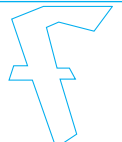

MOBILE WORKSTATIONS INCLUDING 1 19 EH CABINET + 1 19 EH CABINET



■ Detail of the height adjustable shelves (PR) with load capacity of 70 kg.

LOAD CAPACITY

- Workstation: 250 kg
- Drawer: 70 kg
- Adjustable shelf: 70 kg
- 4 edged tray: 70 kg
- Worktop: 250 kg

WORKSTATION WITH MULTIPLEX WORKTOP INCLUDING

ORD. NO.

DRAWERS

F CB H320 01 04

4

2 standard rubber swivel wheels with brakes and
2 standard rubber fixed wheels Ø 150 mm in

4 full extension drawers

2 height adjustable shelves

Overall dimensions mm 937x600x910 h

Multiplex worktop dimensions mm 860x600x25 h

1 lock with anti-tilt rod



MOBILE WORKSTATION

ORD. NO.

F CB H320 S1 08

5 drawers, 1 tray with 4 edges, 3 storage containers
1 rear edge, 2 side edges

Dimensions mm 937x600x910/985 h

Tools and partitioning material excluded

RAL 7000 F.01

RAL 6011 F.02

RAL 5012 F.04

RAL 7035 F.08

KEY ■



■ Partitioning material: see page A180

■ Partitioning material: see page A9

- PR = height adjustable shelf
- T = full extension (100%)
- All indicated loads are net and refer to evenly distributed weights.



WORKSTATION WITH MULTIPLEX WORKTOP INCLUDING

ORD. NO. DRAWERS

F CB H320 04 04 42 standard rubber swivel wheels with brakes and
2 standard rubber fixed wheels Ø 150 mm

4 full extension drawers

2 height adjustable 4 edged trays

Overall dimensions mm 937x600x910 h**Multiplex worktop dimensions mm 860x600x25 h**

1 lock with anti-tilt rod



BACK UPSTAND



ORD. NO.

F BL 5690 00 00

For multiplex worktop dimensions mm 860x600x25 h

SIDE UPSTAND



ORD. NO.

F BL 5595 00 00

For multiplex worktop dimensions mm 860x600x25 h

WORKSTATION WITH MULTIPLEX WORKTOP INCLUDING

ORD. NO. DRAWERS

F CB H330 01 04 42 standard rubber swivel wheels with brakes and
2 standard rubber fixed wheels Ø 150 mm

4 full extension drawers

2 height adjustable shelves

4 practibox drawer units

Overall dimensions mm 1072x600x910 h**Multiplex worktop dimensions mm 995x600x25 h**

1 lock with anti-tilt rod

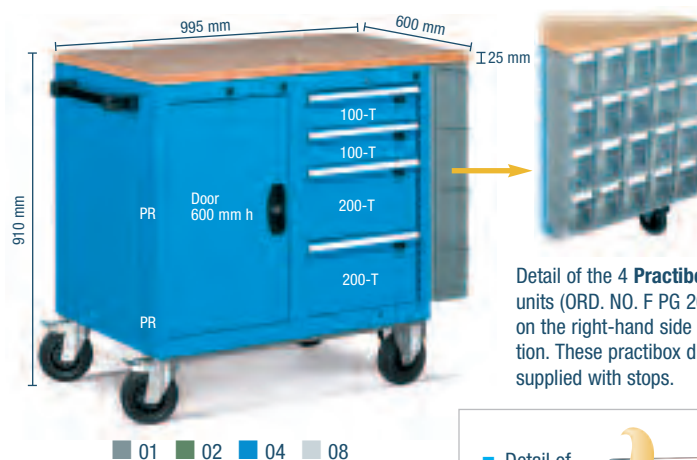

Detail of the 4 Practibox series drawer units (ORD. NO. F PG 2071 01 01) fixed on the right-hand side of the workstation. These practibox drawer units are supplied with stops.

■ Detail of the catches

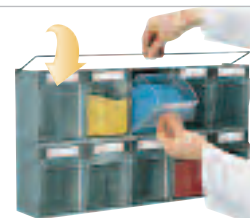

BACK UPSTAND



ORD. NO.

F BL 5705 00 00

For multiplex worktop dimensions mm 995x600x25 h

SIDE UPSTAND



ORD. NO.

F BL 5595 00 00

For multiplex worktop dimensions mm 995x600x25 h

KEY

RAL 7000 F.01 RAL 6011 F.02 RAL 5012 F.04 RAL 7035 F.08



- PR = height adjustable shelf
- VR = height adjustable 4 edged tray
- T = full extension (100%)
- All indicated loads are net and refer to evenly distributed weights.



- Detail of the height adjustable shelves (PR) with load capacity of 70 kg.

- Partitioning material: see page A9



WORKSTATIONS SERIES FLEXA

MOBILE WORKSTATIONS INCLUDING 1 19 EH CABINET + 1 27 EH CABINET



LOAD CAPACITY

- Workstation: 250 kg
- Drawer: 70 kg
- Adjustable shelf: 70 kg
- Retractable shelf: 70 kg
- 4 edged tray: 70 kg
- Worktop: 250 kg

WORKSTATION WITH MULTIPLEX WORKTOP INCLUDING

ORD. NO.

DRAWERS

F CB H420 01 04**4**

2 standard rubber swivel wheels with brakes and
2 standard rubber fixed wheels Ø 150 mm

4 full extension drawers

2 height adjustable shelves

Overall dimensions mm 1072x600x910 h

Multiplex worktop dimensions mm 995x600x25 h

1 lock with anti-tilt rod

WORKSTATION WITH MULTIPLEX WORKTOP INCLUDING

ORD. NO.

DRAWERS

F CB H420 02 04**4**

2 standard rubber swivel wheels with brakes and
2 standard rubber fixed wheels Ø 150 mm

4 full extension drawers

2 height adjustable shelves

Overall dimensions mm 1072x600x910 h

Multiplex worktop dimensions mm 995x600x25 h

2 locks with 300 mm h side rod

WORKSTATION WITH MULTIPLEX WORKTOP INCLUDING

ORD. NO.

DRAWERS

F CB H420 03 04**4**

2 standard rubber swivel wheels with brakes and
2 standard rubber fixed wheels Ø 150 mm

4 full extension drawers

2 full retractable shelves

Overall dimensions mm 1072x600x910 h

Multiplex worktop dimensions mm 995x600x25 h

2 locks with anti-tilt rod

■ Detail of the full retractable shelves (PE) with load capacity of 70 kg.



RAL 7000 F.01

RAL 6011 F.02

RAL 5012 F.04

RAL 7035 F.08

KEY ■

■ Partitioning material: see page A9 and page A19

- PE = full extension retractable shelf (100%)
- PR = height adjustable shelf
- T = full extension (100%)
- All indicated loads are net and refer to evenly distributed weights.



WORKSTATION WITH MULTIPLEX WORKTOP INCLUDING**ORD. NO.** **DRAWERS****F CB H420 04 04** **4**2 standard rubber swivel wheels with brakes and
2 standard rubber fixed wheels Ø 150 mm

4 full extension drawers

2 height adjustable 4 edged trays

Overall dimensions mm 1072x600x910 h**Multiplex worktop dim. mm 995x600x25 h**

1 lock with anti-tilt rod

**BACK UPSTAND****ORD. NO.****F BL 5705 00 00**For multiplex worktop
dimensions mm 995x600x25 h**SIDE UPSTAND****ORD. NO.****F BL 5595 00 00**For multiplex worktop
dimensions mm 995x600x25 h**WORKSTATION WITH TWO 4 EDGED TOPS:****ORD. NO.** **DRAWERS****F CB H440 01 04** **4**2 standard rubber swivel wheels with brakes and
2 standard rubber fixed wheels Ø 150 mm

4 full extension drawers

2 height adjustable shelves

Overall dimensions mm 1070x600x907 h

1 lock with anti-tilt rod



- 4 edged top including oil-resistant rubber.
- Worktop load capacity: 80+80 kg

WORKSTATION WITH MULTIPLEX WORKTOP INCLUDING**ORD. NO.** **DRAWERS****F CB H430 01 04** **4**2 standard rubber swivel wheels with brakes and
2 standard rubber fixed wheels Ø 150 mm

4 full extension drawers

2 height adjustable shelves

4 practibox drawer units

Overall dimensions mm 1227x600x910 h**Multiplex worktop dim. mm 1150x600x25 h**

1 lock with anti-tilt rod

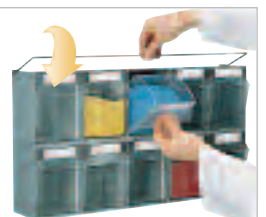
Detail of the 4 **Practibox** series
drawer units (ORD. NO. F PG 2071 01 01)
fixed on the right-hand side of the
workstation. These practibox drawer units
are supplied with catches.**BACK UPSTAND****ORD. NO.****F BL 5715 00 00**For multiplex worktop **dim. mm 1150x600x25 h****SIDE UPSTAND****ORD. NO.****F BL 5595 00 00**For multiplex worktop **dim. mm 1150x600x25 h**■ Detail of
the catches■ **KEY**

RAL 7000 F.01 RAL 6011 F.02 RAL 5012 F.04 RAL 7035 F.08

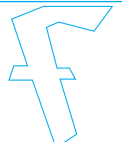
■ Detail of the
height adjustable
shelves (PR) with
load capacity of
70 kg.■ Partitioning
material: see
page A9 and
page A19

- **PR** = height adjustable shelf
- **VR** = height adjustable 4 edged tray
- **T** = full extension (100%)
- All indicated loads are net and refer to evenly distributed weights.

WORKSTATIONS SERIES FLEXA

MOBILE WORKSTATIONS INCLUDING 1 27 EH CABINET + 1 27 EH CABINET



LOAD CAPACITY

- Workstation: 250 kg
- Drawer: 70 kg
- Adjustable shelf: 70 kg
- Retractable shelf: 70 kg
- 4 edged tray: 70 kg
- Worktop: 250 kg

■ Detail of the height adjustable shelves (PR) with load capacity of 70 kg.

WORKSTATION WITH MULTIPLEX WORKTOP INCLUDING

ORD. NO.

DRAWERS

F CB H510 01 04**4**

2 standard rubber swivel wheels with brakes and
2 standard rubber fixed wheels Ø 150 mm

4 full extension drawers

2 height adjustable shelves

Overall dimensions mm 1227x700x915 h

Multiplex worktop dimensions mm 1150x700x30 h

1 lock with anti-tilt rod

ROLLER SHUTTER CABINET

ORD. NO.

F BL 7011 03 51

Overall dimensions mm 952x210x810 h

Internal dimensions mm 905x150x581 h

Hooks and tools excluded

SET OF 41 HOOKS

ORD. NO.

F BL 9511 00 99

WORKSTATION WITH MULTIPLEX WORKTOP INCLUDING

ORD. NO.

DRAWERS

F CB H510 03 04**4**

2 standard rubber swivel wheels with brakes and
2 standard rubber fixed wheels Ø 150 mm

4 full extension drawers

2 full retractable shelves

Overall dimensions mm 1227x700x915 h

Multiplex worktop dimensions mm 1150x700x30 h

2 locks with anti-tilt rod

■ Detail of the full retractable shelves (PE) with load capacity of 70 kg.

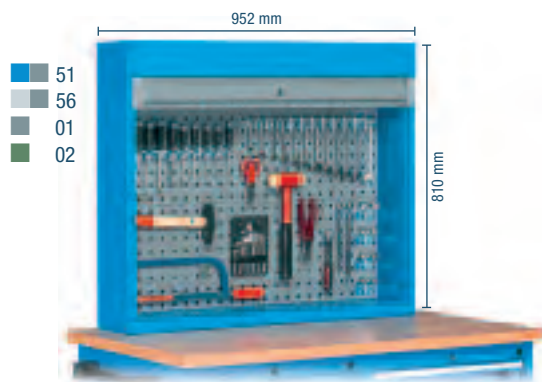

RAL 7000 F.01

RAL 6011 F.02

RAL 5012 F.04

RAL 7035 F.08

KEY ■

■ Partitioning material: see page A19

- PE = full extension retractable shelf (100%)
- PR = height adjustable shelf
- T = full extension (100%)
- All indicated loads are net and refer to evenly distributed weights.



WORKSTATION WITH MULTIPLEX WORKTOP INCLUDING**ORD. NO.** **DRAWERS****F CB H510 04 04** **4**2 standard rubber swivel wheels with brakes and
2 standard rubber fixed wheels Ø 150 mm

4 full extension drawers

2 height adjustable 4 edged trays

Overall dimensions mm 1227x700x915 h**Multiplex worktop dim. mm 1150x700x30 h**

1 lock with anti-tilt rod

**BACK UPSTAND****ORD. NO.****F BL 5715 00 00**For multiplex worktop
dimensions mm 1150x700x30 h**SIDE UPSTAND****ORD. NO.****F BL 5605 00 00**For multiplex worktop
dimensions mm 1150x700x30 h**WORKSTATION WITH TWO 4 EDGED TOPS:****ORD. NO.** **DRAWERS****F CB H540 01 04** **4**2 standard rubber swivel wheels with brakes and
2 standard rubber fixed wheels Ø 150 mm

4 full extension drawers

2 height adjustable shelves

Overall dimensions mm 1206x600x907 h

1 lock with anti-tilt rod



- 4 edged top including oil-resistant rubber.
- Worktop load capacity: 80+80 kg

WORKSTATION WITH MULTIPLEX WORKTOP INCLUDING**ORD. NO.** **DRAWERS****F CB H530 01 04** **4**2 standard rubber swivel wheels with brakes and
2 standard rubber fixed wheels Ø 150 mm

4 full extension drawers

2 height adjustable shelves

4 practibox drawer units

Overall dimensions mm 1352x600x910 h**Multiplex worktop dim. mm 1275x600x25 h**

1 lock with anti-tilt rod



Detail of the 4 **Practibox** series drawer units (ORD. NO. F PG 2071 01 01) fixed on the right-hand side of the workstation. These practibox drawer units are supplied with catches.

BACK UPSTAND**ORD. NO.****F BL 5719 00 00**For multiplex worktop **dim. mm 1275x600x25 h****SIDE UPSTAND****ORD. NO.****F BL 5595 00 00**For multiplex worktop **dim. mm 1275x600x25 h**

■ Detail of the catches

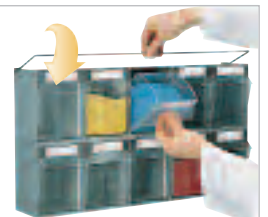
■ **KEY**

RAL 7000 F.01 RAL 6011 F.02 RAL 5012 F.04 RAL 7035 F.08



■ Detail of the height adjustable shelves (PR) with load capacity of 70 kg.

■ Partitioning material: see page A19

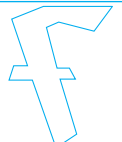

- **PR** = height adjustable shelf
- **VR** = height adjustable 4 edged tray
- **T** = full extension (100%)
- All indicated loads are net and refer to evenly distributed weights.

WORKSTATIONS SERIES FLEXA

MOBILE WORKSTATIONS INCLUDING 1 19 EH CABINET + 1 36 EH CABINET



■ Detail of the height adjustable shelves (PR) with load capacity of 70 kg.

LOAD CAPACITY

- Workstation: 250 kg
- Drawer: 70 kg
- Adjustable shelf: 70 kg
- Retractable shelf: 70 kg
- 4 edged tray: 70 kg
- Worktop: 250 kg

WORKSTATION WITH MULTIPLEX WORKTOP INCLUDING

ORD. NO.

DRAWERS

F CB H610 01 04**4**

2 standard rubber swivel wheels with brakes and
2 standard rubber fixed wheels Ø 150 mm

4 full extension drawers

2 height adjustable shelves

Overall dimensions mm 1227x700x915 h

Multiplex worktop dimensions mm 1150x700x30 h

1 lock with anti-tilt rod

ROLLER SHUTTER CABINET

ORD. NO.

F BL 7011 03 51

Overall dimensions mm 952x210x810 h

Internal dimensions mm 905x150x581 h

Hooks and tools excluded

SET OF 41 HOOKS

ORD. NO.

F BL 9511 00 99

WORKSTATION WITH MULTIPLEX WORKTOP INCLUDING

ORD. NO.

DRAWERS

F CB H610 03 04**4**

2 standard rubber swivel wheels with brakes and
2 standard rubber fixed wheels Ø 150 mm

4 full extension drawers

2 retractable shelves

Overall dimensions mm 1227x700x915 h

Multiplex worktop dimensions mm 1150x700x30 h

2 locks with anti-tilt rod

■ Detail of the full retractable shelves (PE) with load capacity of 70 kg.

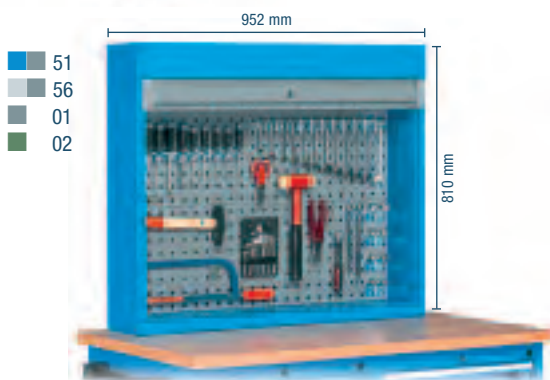

RAL 7000 F.01

RAL 6011 F.02

RAL 5012 F.04

RAL 7035 F.08

KEY

■ Partitioning material: see page A9 and page A29

- PE = full extension retractable shelf (100%)
- PR = height adjustable shelf
- T = full extension (100%)
- All indicated loads are net and refer to evenly distributed weights.



WORKSTATION WITH MULTIPLEX WORKTOP INCLUDING

ORD. NO.	DRAWERS
F CB H610 04 04	4
2 standard rubber swivel wheels with brakes and 2 standard rubber fixed wheels Ø 150 mm	
4 full extension drawers	
2 height adjustable 4 edged trays	
Overall dimensions mm 1227x700x915 h	
Multiplex worktop dim. mm 1150x700x30 h	
1 lock with anti-tilt rod	

ORD. NO.	DRAWERS
F CB H610 05 04	1
2 standard rubber swivel wheels with brakes and 2 standard rubber fixed wheels Ø 150 mm	
1 full extension drawer	
1 height adjustable shelf	
2 height adjustable 4 edged trays	
Overall dimensions mm 1227x700x915 h	
Multiplex worktop dim. mm 1150x700x30 h	
1 lock with side rod	



■ Vices can be fixed on the 30 mm thick worktops.
See page C77 for further information.

WORKSTATION WITH MULTIPLEX WORKTOP INCLUDING

ORD. NO.	DRAWERS
F CB H610 05 04	1
2 standard rubber swivel wheels with brakes and 2 standard rubber fixed wheels Ø 150 mm	
1 full extension drawer	
1 height adjustable shelf	
2 height adjustable 4 edged trays	
Overall dimensions mm 1227x700x915 h	
Multiplex worktop dim. mm 1150x700x30 h	
1 lock with side rod	

ORD. NO.	DRAWERS
F CB H640 01 04	4
2 standard rubber swivel wheels with brakes and 2 standard rubber fixed wheels Ø 150 mm	
4 full extension drawers	
2 height adjustable shelves	
Overall dimensions mm 1223x600x907 h	
1 lock with anti-tilt rod	

WORKSTATION WITH TWO 4 EDGED TOPS:

ORD. NO.	DRAWERS
F CB H640 01 04	4
2 standard rubber swivel wheels with brakes and 2 standard rubber fixed wheels Ø 150 mm	
4 full extension drawers	
2 height adjustable shelves	
Overall dimensions mm 1223x600x907 h	
1 lock with anti-tilt rod	

ORD. NO.	DRAWERS
F CB H640 01 04	4
2 standard rubber swivel wheels with brakes and 2 standard rubber fixed wheels Ø 150 mm	
4 full extension drawers	
2 height adjustable shelves	
Overall dimensions mm 1223x600x907 h	
1 lock with anti-tilt rod	



■ 01 ■ 02 ■ 04 ■ 08



■ 01 ■ 02 ■ 04 ■ 08



■ 01 ■ 02 ■ 04 ■ 08

BACK UPSTAND**ORD. NO.****F BL 5715 00 00**

For multiplex worktop dimensions mm 1150x700x30 h

SIDE UPSTAND**ORD. NO.****F BL 5605 00 00**

For multiplex worktop dimensions mm 1150x700x30 h

BACK UPSTAND**ORD. NO.****F BL 5715 00 00**

For multiplex worktop dimensions mm 1150x700x30 h

SIDE UPSTAND**ORD. NO.****F BL 5605 00 00**

For multiplex worktop dimensions mm 1150x700x30 h

- 4 edged top including oil-resistant rubber.
- Worktop load capacity: 80+80 kg

KEY

■ RAL 7000 F.01 ■ RAL 6011 F.02 ■ RAL 5012 F.04 ■ RAL 7035 F.08



■ Detail of the height adjustable shelves (PR) with load capacity of 70 kg.

■ Partitioning material: see page A9 and page A29

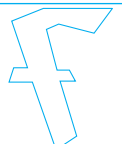

- PR = height adjustable shelf
- VR = height adjustable 4 edged tray
- T = full extension (100%)
- All indicated loads are net and refer to evenly distributed weights.

WORKSTATIONS SERIES FLEXA

MOBILE WORKSTATIONS INCLUDING 1 19 EH CABINET + 1 36 EH CABINET

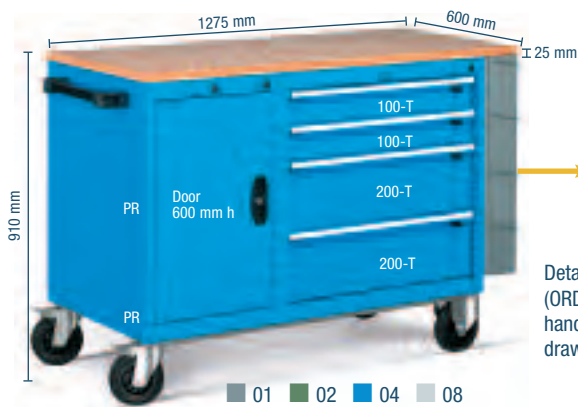

Detail of the 4 Practibox series drawer units (ORD. NO. F PG 2071 01 01) fixed on the right-hand side of the workstation. These practibox drawer units are supplied with catches.

WORKSTATION WITH MULTIPLEX WORKTOP INCLUDING

ORD. NO.	DRAWERS
F CB H630 01 04	4
2 standard rubber swivel wheels with brakes and 2 standard rubber fixed wheels Ø 150 mm	
4 full extension drawers	
2 height adjustable shelves	
4 practibox drawer units	
Overall dimensions mm 1352x600x910 h	
Multiplex worktop dim. mm 1275x600x25 h	
1 lock with anti-tilt rod	

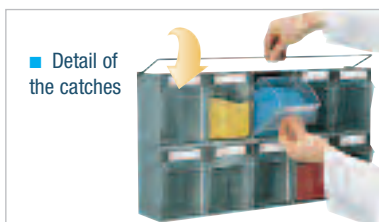

BACK UPSTAND



ORD. NO.
F BL 5719 00 00
For multiplex worktop dim. mm 1275x600x25 h

SIDE UPSTAND



ORD. NO.
F BL 5595 00 00
For multiplex worktop dim. mm 1275x600x25 h



Door 300 mm h
Pneumatic and electric system with drawer 100-T



Possible closure of the flap door by means of the lower drawer. See page A28.



The pneumatic and electric system can be accessed through the lower drawer.

WORKSTATION WITH MULTIPLEX WORKTOP INCLUDING

ORD. NO.	DRAWERS
F CB H610 06 04	7
2 standard rubber swivel wheels with brakes and 2 standard rubber fixed wheels Ø 150 mm	
7 full extension drawers	
1 pneumatic and electric system	
Overall dimensions mm 1227x700x915 h	
Multiplex worktop dim. mm 1150x700x30 h	
2 locks with anti-tilt rod	



Rear 11 metres long pneumatic extension.
Rear 10 metres long electric extension.

ELECTRIC AND PNEUMATIC SYSTEM:
please contact FAMI for detailed information

RAL 7000 F.01 RAL 6011 F.02 RAL 5012 F.04 RAL 7035 F.08

KEY



Partitioning material: see page A9 and page A29

Detail of the height adjustable shelves (PR) with load capacity of 70 kg.



- PR = height adjustable shelf
- T = full extension (100%)
- All indicated loads are net and refer to evenly distributed weights.



- Perforated back panels see page A33
- Hooks see page C66
- Practibox see page G48



■ RAL 7035 + ■ RAL 5012

This system is included in the order no. F CB H610 06 04

SYSTEM INCLUDING:

- 1 (R) electric winder with control unit and differential circuit breaker ORD. NO. F BL 9390 01 00
- 1 (L) 220V Schuko socket ORD. NO. F BL 9395 07 00
- 1 steel frame ORD. NO. F BL 9370 02 07
- 1 (U) pneumatic connection hose (quick connector excluded) ORD. NO. F BL 9401 01 00
- 1 (T) pneumatic feed winder with 11 metres of 10 mm internal Ø hose and 3/8" threaded connector ORD. NO. F BL 9402 02 00
- 1 (B) pneumatic winder with 4 metres of 5,5 mm internal Ø hose and 1/4" threaded connector ORD. NO. F BL 9403 01 00

Electrical system usable power: 1200 W with wound cable, 1800 W with cable completely unwound.

EXAMPLE INCLUDING:

ORD. NO.

F CB H610 S1 50

- 4 drawers
- 1 electric system
- 1 pneumatic system
- 1 flap door
- 1 door
- 1 retractable shelf
- 1 multi-purpose back panel with accessories

Dimensions mm 1227x700x915/1335 h

Tools excluded

■ **KEY**

RAL 7000 F.01

RAL 6011 F.02

RAL 5012 F.04

RAL 7035 F.08



■ Detail of the height adjustable shelves (PR) with load capacity of 70 kg.

■ Partitioning material: see page A9 and page A29

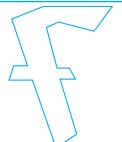

■ All indicated loads are net and refer to evenly distributed weights.

WORKSTATIONS SERIES FLEXA

MOBILE WORKSTATION INCLUDING 1 19 EH CABINET + 1 36 EH CABINET



ORD. NO. F CB H620 S1 EF

RAL 7000 F.01

RAL 6011 F.02

RAL 5012 F.04

RAL 7035 F.08

INFO ■



■ Partitioning material: see page A9 and page A29

■ Detail of the height adjustable shelves (PR) with load capacity of 70 kg.



www.famispa.com



MOBILE WORKSTATION INCLUDING 1 19 EH CABINET + 1 27 EH CABINET

EXAMPLE INCLUDING:

ORD. NO.

F CB H430 S1 71

4 drawers

2 trays with 4 edges

3 Top-Box cases

1 frame including Practibox

Dimensions mm 1227x600x910 h

Tools and partitioning material excluded



■ RAL 7000 + ■ RAL 5012

■ Rear view of the mobile workstation. The side bay is also open in the rear section. Up to 3 Top-Box cases can be located inside ORD. NO. F PG 5561 01 04



■ INFO

RAL 7000 F.01

RAL 6011 F.02

RAL 5012 F.04

RAL 7035 F.08

www.famispa.com

■ Detail of the height adjustable shelves (PR) with load capacity of 70 kg.

■ Partitioning material: see page A9 and page A29



RUBBER WHEELS

STANDARD RUBBER WHEELS

	ORD. NO. C RG DAC11 100	Ø 100 mm				C 130 mm			SWIVEL WHEEL WITH BRAKE				
	SUITABLE FOR CABINET	FLEXA 19	FLEXA 27	FLEXA 36	FLEXA CB	STANDARD B	STANDARD GE	STANDARD G	STANDARD GG	STANDARD GF	STANDARD GB	STANDARD GC	STANDARD GD
	LOAD CAPACITY KG	170	160	150	130	160	-	-	-	-	-	-	-
	ORD. NO. C RG DAC12 125	Ø 125 mm				C 160 mm			SWIVEL WHEEL WITH BRAKE				
	SUITABLE FOR CABINET	FLEXA 19	FLEXA 27	FLEXA 36	FLEXA CB	STANDARD B	STANDARD GE	STANDARD G	STANDARD GG	STANDARD GF	STANDARD GB	STANDARD GC	STANDARD GD
	LOAD CAPACITY KG	245	235	225	205	235	180	160	-	-	-	-	-
	ORD. NO. C RG DAC13 150	Ø 150 mm				C 185 mm			SWIVEL WHEEL WITH BRAKE				
	SUITABLE FOR CABINET	FLEXA 19	FLEXA 27	FLEXA 36	FLEXA CB	STANDARD B	STANDARD GE	STANDARD G	STANDARD GG	STANDARD GF	STANDARD GB	STANDARD GC	STANDARD GD
	LOAD CAPACITY KG	290	280	270	250	280	225	205	-	-	-	-	-
	ORD. NO. C RG DAC15 200	Ø 200 mm				C 242 mm			SWIVEL WHEEL WITH BRAKE				
	SUITABLE FOR CABINET	FLEXA 19	FLEXA 27	FLEXA 36	FLEXA CB	STANDARD B	STANDARD GE	STANDARD G	STANDARD GG	STANDARD GF	STANDARD GB	STANDARD GC	STANDARD GD
	LOAD CAPACITY KG	-	-	-	-	550	495	475	455	445	435	415	395
	ORD. NO. C RG BAC11 100	Ø 100 mm				C 130 mm			FIXED WHEEL				
	SUITABLE FOR CABINET	FLEXA 19	FLEXA 27	FLEXA 36	FLEXA CB	STANDARD B	STANDARD GE	STANDARD G	STANDARD GG	STANDARD GF	STANDARD GB	STANDARD GC	STANDARD GD
	LOAD CAPACITY KG	170	160	150	130	160	-	-	-	-	-	-	-
	ORD. NO. C RG BAC12 125	Ø 125 mm				C 160 mm			FIXED WHEEL				
	SUITABLE FOR CABINET	FLEXA 19	FLEXA 27	FLEXA 36	FLEXA CB	STANDARD B	STANDARD GE	STANDARD G	STANDARD GG	STANDARD GF	STANDARD GB	STANDARD GC	STANDARD GD
	LOAD CAPACITY KG	245	235	225	205	235	180	160	-	-	-	-	-
	ORD. NO. C RG BAC13 150	Ø 150 mm				C 185 mm			FIXED WHEEL				
	SUITABLE FOR CABINET	FLEXA 19	FLEXA 27	FLEXA 36	FLEXA CB	STANDARD B	STANDARD GE	STANDARD G	STANDARD GG	STANDARD GF	STANDARD GB	STANDARD GC	STANDARD GD
	LOAD CAPACITY KG	290	280	270	250	280	225	205	-	-	-	-	-
	ORD. NO. C RG BAC15 200	Ø 200 mm				C 242 mm			FIXED WHEEL				
	SUITABLE FOR CABINET	FLEXA 19	FLEXA 27	FLEXA 36	FLEXA CB	STANDARD B	STANDARD GE	STANDARD G	STANDARD GG	STANDARD GF	STANDARD GB	STANDARD GC	STANDARD GD
	LOAD CAPACITY KG	-	-	-	-	550	495	475	455	445	435	415	395

ELASTIC RUBBER WHEELS



ORD. NO. C RG DCE15 125 \varnothing 125 mm C 160 mm **SWIVEL WHEEL WITH BRAKE**

SUITABLE FOR CABINET	FLEXA 19	FLEXA 27	FLEXA 36	FLEXA CB	STANDARD B	STANDARD GE	STANDARD G	STANDARD GG	STANDARD GF	STANDARD GB	STANDARD GC	STANDARD GD
LOAD CAPACITY KG	400	400	270	445	475	420	400	380	370	360	340	320



ORD. NO. C RG DCE15 160 \varnothing 160 mm C 204 mm **SWIVEL WHEEL WITH BRAKE**

SUITABLE FOR CABINET	FLEXA 19	FLEXA 27	FLEXA 36	FLEXA CB	STANDARD B	STANDARD GE	STANDARD G	STANDARD GG	STANDARD GF	STANDARD GB	STANDARD GC	STANDARD GD
LOAD CAPACITY KG	-	-	-	-	600	600	600	600	600	600	600	600



ORD. NO. C RG BCE15 125 \varnothing 125 mm C 160 mm **FIXED WHEEL**

SUITABLE FOR CABINET	FLEXA 19	FLEXA 27	FLEXA 36	FLEXA CB	STANDARD B	STANDARD GE	STANDARD G	STANDARD GG	STANDARD GF	STANDARD GB	STANDARD GC	STANDARD GD
LOAD CAPACITY KG	400	400	270	445	475	420	400	380	370	360	340	320



ORD. NO. C RG BCE15 160 \varnothing 160 mm C 204 mm **FIXED WHEEL**

SUITABLE FOR CABINET	FLEXA 19	FLEXA 27	FLEXA 36	FLEXA CB	STANDARD B	STANDARD GE	STANDARD G	STANDARD GG	STANDARD GF	STANDARD GB	STANDARD GC	STANDARD GD
LOAD CAPACITY KG	-	-	-	-	600	600	600	600	600	600	600	600

NO-SMEAR RUBBER WHEELS



ORD. NO. C RG DPH22 125 \varnothing 125 mm C 160 mm **SWIVEL WHEEL WITH BRAKE**

SUITABLE FOR CABINET	FLEXA 19	FLEXA 27	FLEXA 36	FLEXA CB	STANDARD B	STANDARD GE	STANDARD G	STANDARD GG	STANDARD GF	STANDARD GB	STANDARD GC	STANDARD GD
LOAD CAPACITY KG	245	235	225	205	235	180	160	-	-	-	-	-



ORD. NO. C RG DPH25 160 \varnothing 160 mm C 204 mm **SWIVEL WHEEL WITH BRAKE**

SUITABLE FOR CABINET	FLEXA 19	FLEXA 27	FLEXA 36	FLEXA CB	STANDARD B	STANDARD GE	STANDARD G	STANDARD GG	STANDARD GF	STANDARD GB	STANDARD GC	STANDARD GD
LOAD CAPACITY KG	-	-	-	-	535	480	460	440	430	420	400	380



ORD. NO. C RG BPH22 125 \varnothing 125 mm C 160 mm **FIXED WHEEL**

SUITABLE FOR CABINET	FLEXA 19	FLEXA 27	FLEXA 36	FLEXA CB	STANDARD B	STANDARD GE	STANDARD G	STANDARD GG	STANDARD GF	STANDARD GB	STANDARD GC	STANDARD GD
LOAD CAPACITY KG	245	235	225	205	235	180	160	-	-	-	-	-



ORD. NO. C RG BPH25 160 \varnothing 160 mm C 204 mm **FIXED WHEEL**

SUITABLE FOR CABINET	FLEXA 19	FLEXA 27	FLEXA 36	FLEXA CB	STANDARD B	STANDARD GE	STANDARD G	STANDARD GG	STANDARD GF	STANDARD GB	STANDARD GC	STANDARD GD
LOAD CAPACITY KG	-	-	-	-	535	480	460	440	430	420	400	380

CONDUCTIVE WHEELS

CONDUCTIVE WHEELS

	ORD. NO. C RG DDD11 100	\varnothing 100 mm		C 130 mm		SWIVEL WHEEL WITH BRAKE							
	SUITABLE FOR CABINET	FLEXA 19	FLEXA 27	FLEXA 36	FLEXA CB	STANDARD B	STANDARD GE	STANDARD G	STANDARD GG	STANDARD GF	STANDARD GB	STANDARD GC	STANDARD GD
	LOAD CAPACITY KG	170	160	150	130	160	-	-	-	-	-	-	-
	ORD. NO. C RG CDD11 100	\varnothing 100 mm		C 130 mm		SWIVEL WHEEL WITHOUT BRAKE							
	SUITABLE FOR CABINET	FLEXA 19	FLEXA 27	FLEXA 36	FLEXA CB	STANDARD B	STANDARD GE	STANDARD G	STANDARD GG	STANDARD GF	STANDARD GB	STANDARD GC	STANDARD GD
	LOAD CAPACITY KG	170	160	150	130	160	-	-	-	-	-	-	-
	ORD. NO. C RG CDD13 150	\varnothing 150 mm		C 185 mm		SWIVEL WHEEL WITHOUT BRAKE							
	SUITABLE FOR CABINET	FLEXA 19	FLEXA 27	FLEXA 36	FLEXA CB	STANDARD B	STANDARD GE	STANDARD G	STANDARD GG	STANDARD GF	STANDARD GB	STANDARD GC	STANDARD GD
	LOAD CAPACITY KG	290	280	270	250	280	225	205	-	-	-	-	-
	ORD. NO. C RG BDD11 100	\varnothing 100 mm		C 130 mm		FIXED WHEEL							
	SUITABLE FOR CABINET	FLEXA 19	FLEXA 27	FLEXA 36	FLEXA CB	STANDARD B	STANDARD GE	STANDARD G	STANDARD GG	STANDARD GF	STANDARD GB	STANDARD GC	STANDARD GD
	LOAD CAPACITY KG	170	160	150	130	160	-	-	-	-	-	-	-
	ORD. NO. C RG BDD13 150	\varnothing 150 mm		C 185 mm		FIXED WHEEL							
	SUITABLE FOR CABINET	FLEXA 19	FLEXA 27	FLEXA 36	FLEXA CB	STANDARD B	STANDARD GE	STANDARD G	STANDARD GG	STANDARD GF	STANDARD GB	STANDARD GC	STANDARD GD
	LOAD CAPACITY KG	290	280	270	250	280	225	205	-	-	-	-	-



■ RAL 7000

INFO ■

www.famispa.com



ORGANIZE SPACE

LET'S REORG

- **DRAWER CABINETS SERIES STANDARD**
- **CABINETS WITH DOORS SERIES STANDARD**
- **COMPUTER CABINETS SERIES STANDARD**

NORMAL EXTENSION DRAWER 87% OR TELESCOPIC FULL EXTENSION 100%

STRONG AND RELIABLE THROUGH TIME

SEVERAL SERIES AVAILABLE

ORGANIZE SPACE LET'S REOR

STANDARD

LOCKS



 ■ This type of lock can be assembled to all drawers of the series STANDARD cabinets



DRAWERS SINGLE LOCK

ORD. NO.

F AG 9199 00 07

Complete with:

1 steel support

1 cylinder lock

with 2 keys series 45

Lock available in black RAL 9011.



SECURITY SHELF BETWEEN DRAWERS

ORD. NO.

FOR CABINETS SERIES

F AG 9190 00 04

F DD 10 (27x36 EH)

F AG 9188 00 04

F AG 20 (36x36 EH)

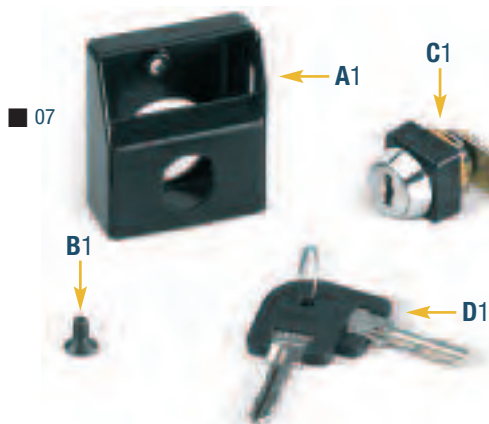

SPARE LOCK

SUPPORT

ORD. NO.

REFERENCE

R XAG 0009 07

A1+B1

LOCK

ORD. NO.

REFERENCE

R CSR 0034 00

C1+D1

RAL 7000 F.01 RAL 6011 F.02 RAL 5012 F.04 RAL 7035 F.08

SUPPLEMENTARY PARTS ■

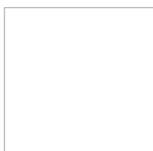
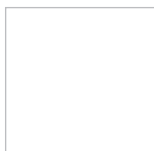
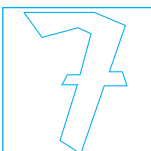

■ **Spare key.** Always indicate the number on the cylinder lock of the key to be replaced.

ORD. NO. R CSC 0002 00

■ **Master key.** This type of key opens all the 45 and 46 series locks.

ORD. NO. R CSC 0001 00





■ RAL 7035

CABINET WITH WHEELS

ORD. NO.

F DD E550 S1 08

Complete with:

4 drawers with single lock

3 security shelves

Dimensions mm 575x815x797 h

Tools and partitioning material excluded

■ INFO

RAL 7000 F.01

RAL 6011 F.02

RAL 5012 F.04

RAL 7035 F.08

■ Partitioning material: see page A180



www.famispa.com





ORD. NO. F DD 1291 S1 EF
RAL 7000+7035



ORD. NO. F DD E550 S1 08
RAL 7035

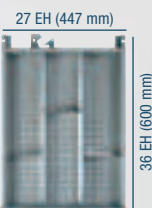

FIXING SET



2x

- 2 "HILTI" plugs for concrete floors \geq to classes B25/RBK250/MPa 25 N/mm²
- Recommended traction of the plug: 2.9 KN
- Plug diameter: \varnothing 6 mm

ORD. NO. F AG 9204 00 99

CABINET FLOOR FIXING SET

- Pair of spare galvanised brackets
- \varnothing 6 mm hole



ORD. NO. F AG 9200 00 99

CABINET

ORD. NO.

F DD 1291 S1 EF

- Complete with 3 drawers
- 1 600 mm height door
- 1 adjustable shelf, 1 retractable shelf
- 1 MDF shelf with rubber covering
- Dimensions mm 564x726x1030 h**
- Tools excluded

CABINET WITH WHEELS

ORD. NO.

F DD E550 S1 08

- Complete with
- 4 drawers with single lock
- 3 security shelves
- Dimensions mm 575x815x797 h**
- Partitioning material excluded

RAL 7000 F.01

RAL 6011 F.02

RAL 5012 F.04

RAL 7035 F.08

SUPPLEMENTARY PARTS ■



- Partitioning material: see page A72-A73



- **Spare key.** Always indicate the number on the cylinder lock of the key to be replaced.
ORD. NO. R CSC 0002 00
- **Master key.** This type of key opens all the 45 and 46 series locks.
ORD. NO. R CSC 0001 00



LENGTH = 564 mm DEPTH = 726 mm (27x36 Eh)

CABINETS SERIES STANDARD B

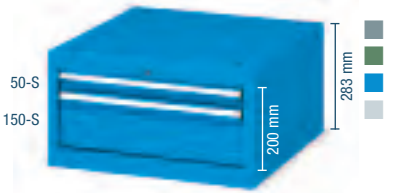

• **ORD. NO.** DRAWERS
F DD 1020 51 04 2
 Cabinet with 2 normal extension drawers
 Dim. mm 564x726x283 h Central lock



• **ORD. NO.** DRAWERS
F DD 1020 52 04 2
 Cabinet with 2 normal extension drawers
 Dim. mm 564x726x283 h Central lock



• **ORD. NO.** DRAWERS
F DD 1020 53 04 3
 Cabinet with 3 normal extension drawers
 Dim. mm 564x726x283 h Central lock

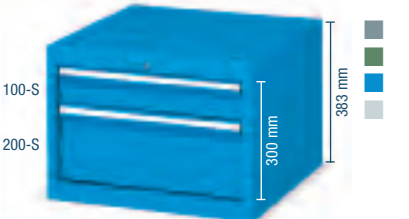

• **ORD. NO.** DRAWERS
F DD 1030 51 04 2
 Cabinet with 2 normal extension drawers
 Dim. mm 564x726x383 h Central lock



• **ORD. NO.** DRAWERS
F DD 1030 55 04 2
 Cabinet with 2 normal extension drawers
 Dim. mm 564x726x383 h Central lock



• **ORD. NO.** DRAWERS
F DD 1030 52 04 3
 Cabinet with 3 normal extension drawers
 Dim. mm 564x726x383 h Central lock

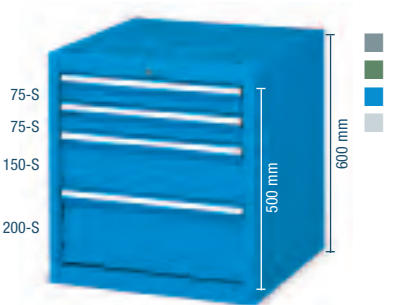

• **ORD. NO.** DRAWERS
F DD 1050 52 04 4
 Cabinet with 4 normal extension drawers
 Dim. mm 564x726x600 h Central lock



• **ORD. NO.** DRAWERS
F DD 1050 53 04 5
 Cabinet with 5 normal extension drawers
 Dim. mm 564x726x600 h Central lock

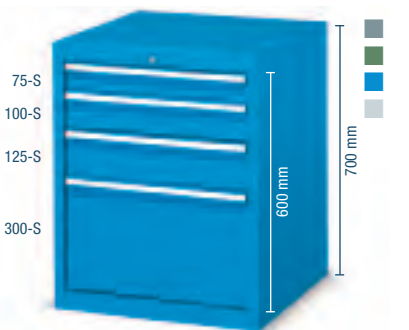

• **ORD. NO.** DRAWERS
F DD 1060 54 04 4
 Cabinet with 4 normal extension drawers
 Dim. mm 564x726x700 h Central lock



• **ORD. NO.** DRAWERS
F DD 1060 51 04 5
 Cabinet with 5 normal extension drawers
 Dim. mm 564x726x700 h Central lock

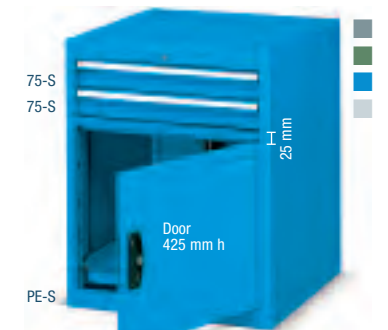

• **ORD. NO.** DRAWERS
F DD 1160 51 04 2
 Cabinet with 2 normal extension drawers
 1 normal retractable shelf
 Dim. mm 564x726x700 h Central lock

KEY

- RAL 7000 F.01
- RAL 6011 F.02
- RAL 5012 F.04
- RAL 7035 F.08



- The cabinets must be secured to the floor or to the wall.
- PE-S = normal retractable shelf (87%)
- S = normal extension (87%)



Detail of the normal retractable shelves (PE-S) with load capacity of 70 kg.

Partitioning material: see page A72-A73

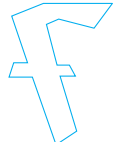

CABINETS SERIES STANDARD B

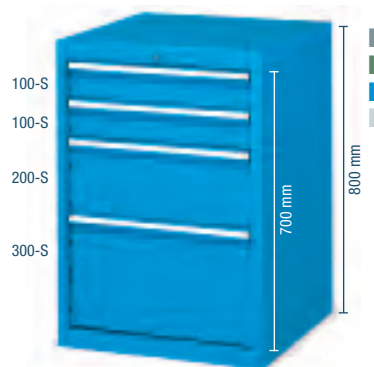

ORD. NO.

DRAWERS

F DD 1070 55 04**4**

Cabinet with 4 normal extension drawers

Dim. mm 564x726x800 h

Central lock



ORD. NO.

DRAWERS

F DD 1070 51 04**5**

Cabinet with 5 normal extension drawers

Dim. mm 564x726x800 h

Central lock



ORD. NO.

DRAWERS

F DD 1070 52 04**6**

Cabinet with 6 normal extension drawers

Dim. mm 564x726x800 h

Central lock

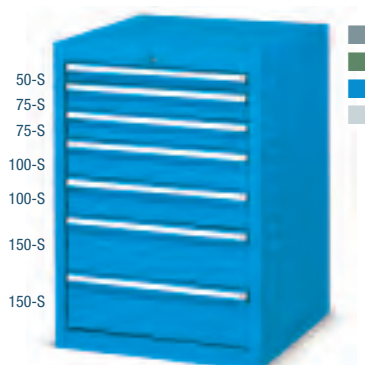

ORD. NO.

DRAWERS

F DD 1070 53 04**7**

Cabinet with 7 normal extension drawers

Dimensions mm 564x726x800 h

Central lock

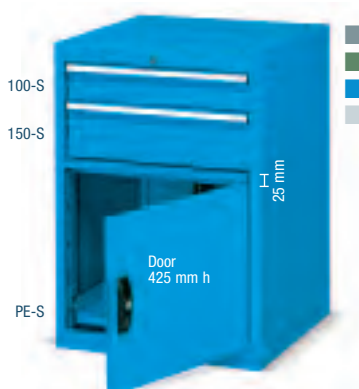

ORD. NO.

DRAWERS

F DD 1170 51 04**2**

Cabinet with 2 normal extension drawers

1 normal retractable shelf

Dim. mm 564x726x800 h

Central lock

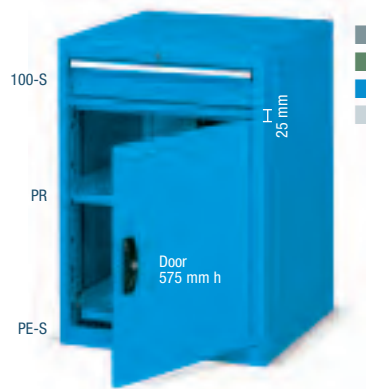

ORD. NO.

DRAWERS

F DD 1270 51 04**1**

Cabinet with 1 normal extension drawer

1 adjustable shelf, 1 normal retractable shelf

Dim. mm 564x726x800 h

Central lock



ORD. NO.

DRAWERS

F DD 1072 51 04**5**

Cabinet with 5 normal extension drawers

Dimensions mm 564x726x825 h

Central lock



ORD. NO.

DRAWERS

F DD 1072 52 04**6**

Cabinet with 6 normal extension drawers

Dimensions mm 564x726x825 h

Central lock

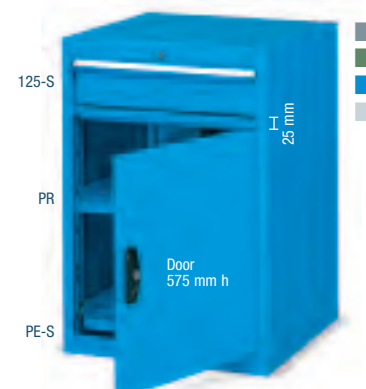

ORD. NO.

DRAWERS

F DD 1272 51 04**1**

Cabinet with 1 normal extension drawer

1 adjustable shelf, 1 normal retractable shelf

Dim. mm 564x726x825 h

Central lock

RAL 7000 F.01

RAL 6011 F.02

RAL 5012 F.04

RAL 7035 F.08

KEY ■



■ Partitioning material: see page A72-A73

■ Detail of the normal retractable shelves (PE-S) with load capacity of 70 kg.



- The cabinets must be secured to the floor or to the wall.
- PE-S = normal retractable shelf (87%)
- PR = height adjustable shelf
- S = normal extension (87%)



LENGTH = 564 mm DEPTH = 726 mm (27x36 Eh)

CABINETS SERIES STANDARD B



•ORD. NO. DRAWERS
F DD 1075 51 04 5
 Cabinet with 5 normal extension drawers
 Dim. mm 564x726x850 h Central lock



•ORD. NO. DRAWERS
F DD 1075 52 04 6
 Cabinet with 6 normal extension drawers
 Dim. mm 564x726x850 h Central lock



•ORD. NO. DRAWERS
F DD 1075 53 04 7
 Cabinet with 7 normal extension drawers
 Dim. mm 564x726x850 h Central lock



•ORD. NO. DRAWERS
F DD 1075 54 04 8
 Cabinet with 8 normal extension drawers
 Dimensions mm 564x726x850 h
 Central lock

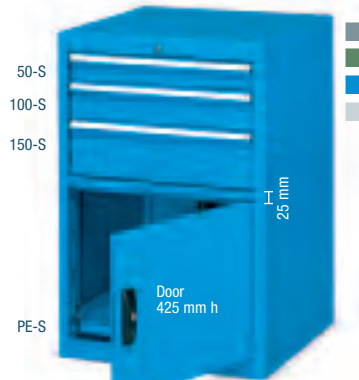

•ORD. NO. DRAWERS
F DD 1175 51 04 3
 Cabinet with 3 normal extension drawers
 1 normal retractable shelf
 Dim. mm 564x726x850 h Central lock

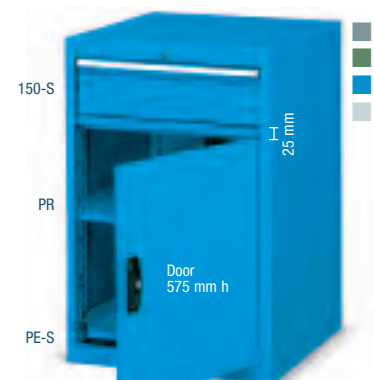

•ORD. NO. DRAWERS
F DD 1275 51 04 1
 Cabinet with 1 normal extension drawer
 1 adjustable shelf, 1 normal retractable shelf
 Dim. mm 564x726x850 h Central lock

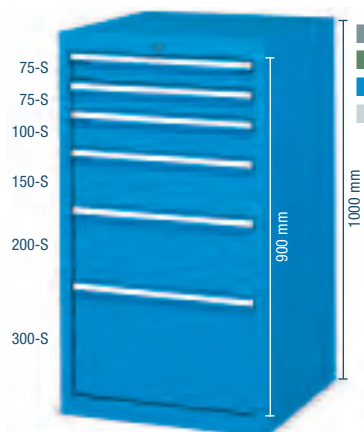

•ORD. NO. DRAWERS
F DD 1090 52 04 6
 Cabinet with 6 normal extension drawers
 Dimensions mm 564x726x1000 h
 Central lock



•ORD. NO. DRAWERS
F DD 1090 51 04 7
 Cabinet with 7 normal extension drawers
 Dimensions mm 564x726x1000 h
 Central lock

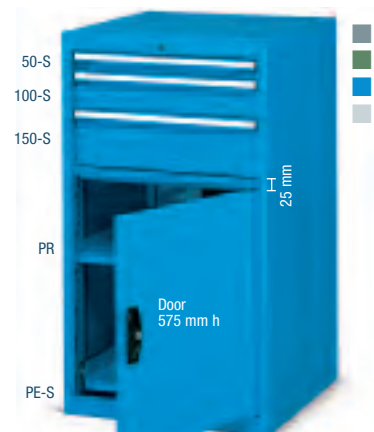

•ORD. NO. DRAWERS
F DD 1290 51 04 3
 Cabinet with 3 normal extension drawers
 1 adjustable shelf, 1 normal retractable shelf
 Dim. mm 564x726x1000 h Central lock

KEY

- RAL 7000 F.01
- RAL 6011 F.02
- RAL 5012 F.04
- RAL 7035 F.08



- The cabinets must be secured to the floor or to the wall.
- PE-S = normal retractable shelf (87%)
- PR = height adjustable shelf
- S = normal extension (87%)



Detail of the normal retractable shelves (PE-S) with load capacity of 70 kg.

Partitioning material: see page A72-A73

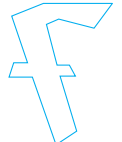

CABINETS SERIES STANDARD B

LENGTH = 564 mm DEPTH = 726 mm (27x36 Eh)



■ RAL 7000 + ■ RAL 7035

EXAMPLE INCLUDING:**ORD. NO.****F DD ZA01 00 EF**3 cabinets with drawers, doors,
adjustable shelves, retractable shelves,
Mdf top with rubber**Dimensions mm 1695x726x1030 h**

Tools and partitioning material excluded

ORD. NO. F BL 1020 00 00

Steel vice 130 mm

**ORD. NO. F DD E550 S1 08**

■ RAL 7035

ORD. NO. F DD E030 02 08

■ RAL 7035

EXAMPLE INCLUDING:**WORKSTATION****ORD. NO.****F BI A370 01 08**Workstation complete with 2 legs
40 mm thick multiplex worktop**Dimensions mm 2000x800x840 h****CABINET WITH WHEELS****ORD. NO.****F DD E550 S1 08**Complete with 4 drawers with single lock
3 security shelves**Dimensions mm 575x815x797 h****CABINET WITH WHEELS****ORD. NO.****F DD E030 02 08**

Complete with 3 drawers

Dimensions mm 575x815x772 h

Partitioning material excluded

RAL 7000 F.01

RAL 6011 F.02

RAL 5012 F.04

RAL 7035 F.08

INFO ■■ Partitioning
material: see
page A72-A73■ The handles can be
fitted towards the
bottom thereby
reducing the height
by 38 mm.www.famispa.com

LENGTH = 564 mm DEPTH = 726 mm (27x36 Eh)

CABINETS SERIES STANDARD B



ORD. NO.	DRAWERS
F DD D020 01 04	2
Cabinet with 2 normal extension drawers	
Ø100 mm standard rubber wheels	
Cabinet load capacity: 160 kg	
Dim. mm 575x815x810 h	
	Central lock



ORD. NO.	DRAWERS
F DD D020 02 04	2
Cabinet with 2 normal extension drawers	
Ø100 mm standard rubber wheels	
Cabinet load capacity: 160 kg	
Dim. mm 575x815x810 h	
	Central lock



ORD. NO.	DRAWERS
F DD D020 03 04	3
Cabinet with 3 normal extension drawers	
Ø100 mm standard rubber wheels	
Cabinet load capacity: 160 kg	
Dim. mm 575x815x810 h	
	Central lock



ORD. NO.	DRAWERS
F DD E030 01 04	2
Cabinet with 2 normal extension drawers	
Ø100 mm nylon wheels	
Cabinet load capacity: 310 kg	
Dim. mm 575x815x810 h	
	Central lock



ORD. NO.	DRAWERS
F DD E030 02 04	3
Cabinet with 3 normal extension drawers	
Ø100 mm nylon wheels	
Cabinet load capacity: 310 kg	
Dim. mm 575x815x810 h	
	Central lock



ORD. NO.	DRAWERS
F DD E030 04 04	4
Cabinet with 4 normal extension drawers	
Ø100 mm nylon wheels	
Cabinet load capacity: 310 kg	
Dim. mm 575x815x810 h	
	Central lock



ORD. NO.	DRAWERS
F DD E550 01 04	3
Cabinet with 3 normal extension drawers	
Ø100 mm nylon wheels. Cabinet load capacity: 310 kg	
Dim. mm 575x815x797 h	
	Central lock



ORD. NO.	DRAWERS
F DD E550 02 04	4
Cabinet with 4 normal extension drawers	
Ø100 mm nylon wheels. Cabinet load capacity: 310 kg	
Dim. mm 575x815x797 h	
	Central lock



ORD. NO.	DRAWERS
F DD E550 03 04	5
Cabinet with 5 normal extension drawers	
Ø100 mm nylon wheels. Cabinet load capacity: 310 kg	
Dim. mm 575x815x797 h	
	Central lock

KEY

- RAL 7000 F.01
- RAL 6011 F.02
- RAL 5012 F.04
- RAL 7035 F.08



- S = normal extension (87%)
- All indicated loads are net and refer to evenly distributed weights.



■ The handles can be fitted towards the bottom thereby reducing the height by 38 mm.

■ Partitioning material: see page A72-A73



CABINETS SERIES STANDARD B



• ORD. NO.	DRAWERS
F DD E560 04 04	4
Cabinet with 4 normal extension drawers	
Ø 100 mm nylon wheels	
Cabinet load capacity: 310 kg	
Dimensions mm 575x815x897 h	
Central lock	



• ORD. NO.	DRAWERS
F DD E560 01 04	5
Cabinet with 5 normal extension drawers	
Ø 100 mm nylon wheels	
Cabinet load capacity: 310 kg	
Dimensions mm 575x815x897 h	
Central lock	



• ORD. NO.	DRAWERS
F DD E560 02 04	6
Cabinet with 5 normal extension drawers	
Ø 100 mm nylon wheels	
Cabinet load capacity: 310 kg	
Dimensions mm 575x815x897 h	
Central lock	



• ORD. NO.	DRAWERS
F DD E570 01 04	5
Cabinet with 5 normal extension drawers	
Ø 100 mm nylon wheels	
Cabinet load capacity: 310 kg	
Dimensions mm 575x815x997 h	
Central lock	



• ORD. NO.	DRAWERS
F DD E570 02 04	6
Cabinet with 6 normal extension drawers	
Ø 100 mm nylon wheels	
Cabinet load capacity: 310 kg	
Dimensions mm 575x815x997 h	
Central lock	



• ORD. NO.	DRAWERS
F DD E570 03 04	7
Cabinet with 7 normal extension drawers	
Ø 100 mm nylon wheels	
Cabinet load capacity: 310 kg	
Dimensions mm 575x815x997 h	
Central lock	

RAL 7000 F.01

RAL 6011 F.02

RAL 5012 F.04

RAL 7035 F.08

KEY ■



■ Partitioning material: see page A72-A73

■ The handles can be fitted towards the bottom thereby reducing the height by 38 mm.



- S = normal extension (87%)
- All indicated loads are net and refer to evenly distributed weights.



LENGTH = 564 mm DEPTH = 726 mm (27x36 Eh)

CABINETS SERIES STANDARD B



•ORD. NO.	DRAWERS
F DD E575 01 04	5
Cabinet with 5 normal extension drawers	
Ø 100 mm nylon wheels	
Cabinet load capacity: 310 kg	
Dimensions mm 575x815x1047 h	
Central lock	



•ORD. NO.	DRAWERS
F DD E575 02 04	6
Cabinet with 6 normal extension drawers	
Ø 100 mm nylon wheels	
Cabinet load capacity: 310 kg	
Dimensions mm 575x815x1047 h	
Central lock	



ORD. NO.	DRAWERS
F DD E575 03 04	7
Cabinet with 7 normal extension drawers	
Ø 100 mm nylon wheels	
Cabinet load capacity: 310 kg	
Dimensions mm 575x815x1047 h	
Central lock	



•ORD. NO.	DRAWERS
F DD E590 01 04	6
Cabinet with 6 normal extension drawers	
Ø 100 mm nylon wheels	
Cabinet load capacity: 310 kg	
Dimensions mm 575x815x1197 h	
Central lock	



•ORD. NO.	DRAWERS
F DD E590 02 04	7
Cabinet with 7 normal extension drawers	
Ø 100 mm nylon wheels	
Cabinet load capacity: 310 kg	
Dimensions mm 575x815x1197 h	
Central lock	



•ORD. NO.	DRAWERS
F DD E590 03 04	8
Cabinet with 8 normal extension drawers	
Ø 100 mm nylon wheels	
Cabinet load capacity: 310 kg	
Dimensions mm 575x815x1197 h	
Central lock	

KEY

RAL 7000 F.01 RAL 6011 F.02 RAL 5012 F.04 RAL 7035 F.08



- S = normal extension (87%)
- All indicated loads are net and refer to evenly distributed weights.



■ The handles can be fitted towards the bottom thereby reducing the height by 38 mm.

■ Partitioning material: see page A72-A73

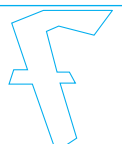

CABINETS SERIES STANDARD B

EMPTY CABINETS PREPARED FOR DRAWERS

ORD. NO.	USABLE HEIGHT mm	LOAD CAPACITY kg	DIMENSIONS mm
F DD 1020 00 04	200	3100	564x726x283 h
F DD 1030 00 04	300	3100	564x726x383 h
F DD 1050 00 04	500	3100	564x726x600 h
F DD 1060 00 04	600	3100	564x726x700 h
F DD 1070 00 04	700	3100	564x726x800 h
F DD 1072 00 04	725	3100	564x726x825 h
F DD 1075 00 04	750	3100	564x726x850 h
F DD 1090 00 04	900	3100	564x726x1000 h



■ 01 ■ 02 ■ 04 ■ 08

■ The cabinets must be secured to the floor or to the wall. If the cabinets are stacked they must be secured to the wall and their load capacity must be divided by 2. Further information for fixing set see page A60.

EMPTY CABINET WITH DOOR – DOOR WITH RIGHT-HAND OPENING

ORD. NO.	DOOR HEIGHT mm	USABLE HEIGHT mm	LOAD CAPACITY kg	DIMENSIONS mm
F DD 1260 D0 04	600	600	3100	564x726x700 h



■ 01
■ 02
■ 04
■ 08

EMPTY CABINET WITH DOOR – DOOR WITH LEFT-HAND OPENING

ORD. NO.	DOOR HEIGHT mm	USABLE HEIGHT mm	LOAD CAPACITY kg	DIMENSIONS mm
F DD 1261 D0 04	600	600	3100	564x726x700 h

■ Drawers cannot be fitted behind doors

EMPTY CABINETS PREPARED FOR DOORS

ORD. NO.	DOOR HEIGHT (A) mm	DRAWERS HEIGHT (B) mm	USABLE HEIGHT (C) mm	LOAD CAPACITY kg	DIMENSIONS mm
F DD 1150 00 04	400	75	500	3100	564x726x600 h
	400	175			
F DD 1160 00 04	425	150	600	3100	564x726x700 h
	500	75			
	400	275			
F DD 1170 00 04	425	250	700	3100	564x726x800 h
	500	175			
	575	100			
	600	75			
F DD 1172 00 04	400	300	725	3100	564x726x825 h
	425	275			
	500	200			
	575	125			
F DD 1175 00 04	600	100	750	3100	564x726x850 h
	400	325			
	425	300			
	500	225			
F DD 1190 00 04	575	150	900	3100	564x726x1000 h
	600	125			
	400	475			
	425	450			
	500	375			
	575	300			
	600	275			

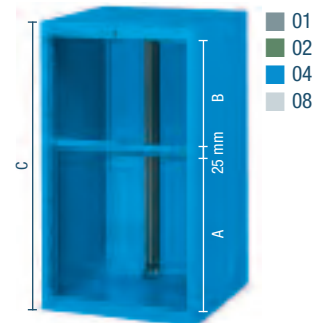

■ Drawers cannot be fitted behind doors

REVERSIBLE DOOR

ORD. NO.	HEIGHT (A) mm
F DD 9640 01 04	400
F DD 9642 01 04	425
F DD 9645 01 04	500
F DD 9649 01 04	575
F DD 9650 01 04	600



■ Drawers cannot be fitted behind doors

■ The door can be fitted both with left-hand and right-hand opening.

■ 01 ■ 02 ■ 04 ■ 08

SPARE LOCK AND SPARE HANDLE

ORD. NO.
R CSR 0003 00
Spare lock (for cabinet)
R CSR 0035 00
Spare lock (for doors handle)
R XDA 0002 07
Spare handle (for doors)

LENGTH = 564 mm DEPTH = 726 mm (27x36 Eh)

CABINETS SERIES STANDARD B

CABINET TO CABINET
FIXING

■ The article includes:
4 M8 nuts and bolts

ORD. NO. F AG 9202 00 99

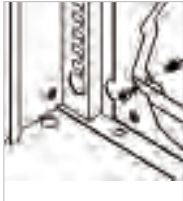

TWO SIDED ADHESIVE TAPE

ORD. NO.

R CMV 0025 00

width 15 mm, length 50 metres

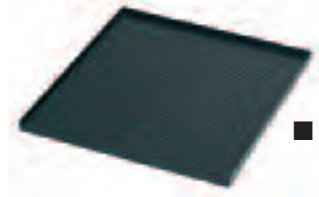

■ 07

CABINET UPSTAND

ORD. NO.

DIMENSIONS mm

F DD 9150 01 07

564x726x20 h

oil-resistant rubber cover top with 3 edges

DRAWERS

ORD. NO.

FRONT HEIGHT mm

LOAD CAPACITY kg

USABLE DIMENSIONS mm

F DD 8050 00 04	50	60	447x600x36 h
F DD 8075 00 04	75	80	447x600x61 h
F DD 8100 00 04	100	100	447x600x86 h
F DD 8125 00 04	125	100	447x600x111 h
F DD 8150 00 04	150	100	447x600x136 h
F DD 8200 00 04	200	100	447x600x186 h
F DD 8250 00 04	250	100	447x600x236 h
F DD 8300 00 04	300	100	447x600x286 h

Normal extension (87%)



■ 01
■ 02
■ 04
■ 08

■ Drawers cannot be fitted behind doors

■ Partitioning material:
see page A72



RETRACTABLE SHELVES

ORD. NO.

SIDE HEIGHT mm

LOAD CAPACITY kg

USABLE DIMENSIONS mm

F DD 8000 00 04	-	70	435x610
-----------------	---	----	---------

Normal extension (87%)

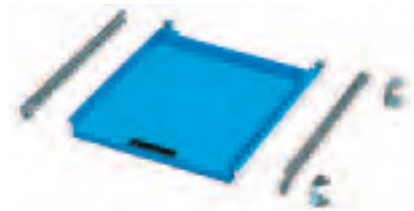

■ 01
■ 02
■ 04

ADJUSTABLE SHELVES

ORD. NO.

SIDE HEIGHT mm

LOAD CAPACITY kg

USABLE DIMENSIONS mm

F DD 9100 01 04	-	70	500x600
-----------------	---	----	---------

Without extension system



■ 01
■ 02
■ 04

PLINTHS

ORD. NO.

HEIGHT mm

F DD 9300 00 07	50
F DD 9330 00 07	100



■ 07

■ KEY

RAL 7000 F.01

RAL 6011 F.02

RAL 5012 F.04

RAL 7035 F.08



■ All indicated loads are net and refer to evenly distributed weights.

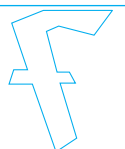

CABINETS SERIES STANDARD B

UPPER MDF TOP WITH RUBBER COVERING DIMENSIONS 565x726x31,5 mm H

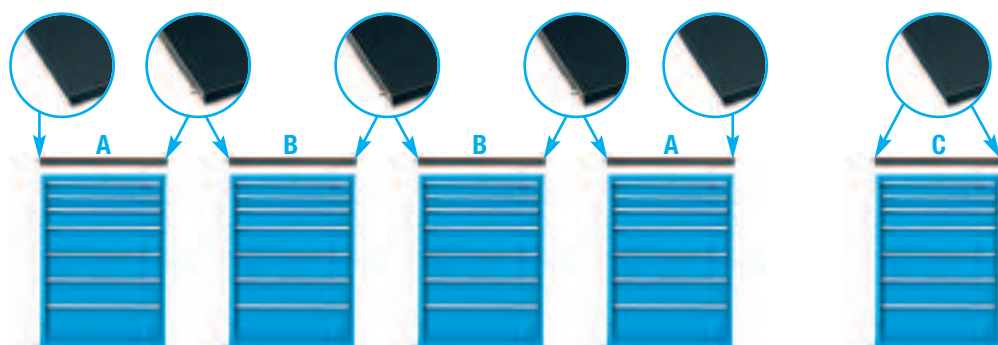

Detail of the oil-resistant rubber

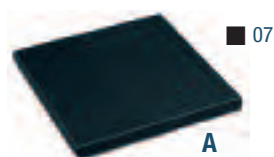

■ 07

A



■ 07

B

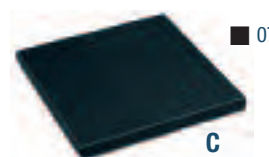

■ 07

C

ORD. NO.

F UZ 3200 11 07

MDF top with rubber covering

Side profile

For end cabinets

Oil-resistant rubber mat

ORD. NO.

F UZ 3200 12 07

MDF top with rubber covering

No side profile

For additional central cabinets

Oil-resist. rubber mat

ORD. NO.

F UZ 3200 13 07

MDF top with rubber covering

2 side profiles

For single cabinet

Oil-resistant rubber mat



RAL 7000 F.01

RAL 6011 F.02

RAL 5012 F.04

RAL 7035 F.08

KEY ■

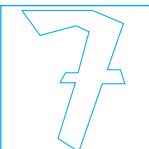

■ The handles can be fitted towards the bottom thereby reducing the height by 38 mm.



■ All indicated loads are net and refer to evenly distributed weights.



LENGTH = 564 mm DEPTH = 726 mm (27x36 Eh)

CABINETS SERIES STANDARD B

CABINETS PREPARED FOR WHEELS

Cabinet prepared for wheels including: wheel plate, 4 edged top with oil-resistant rubber, 2 steel handles covered with shock-resistant rubber, cylinder lock with 2 keys, anti-tilt rod.

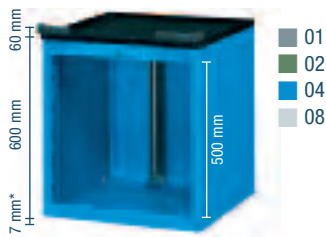

01
02
04
08

ORD. NO.

F DD 0550 00 04

Overall dim. mm 575x815x667 h without wheels

*Wheel plate thickness

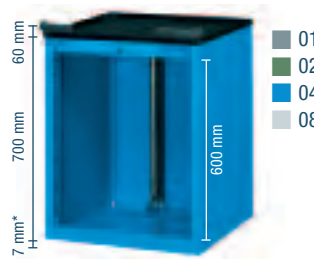

01
02
04
08

ORD. NO.

F DD 0560 00 04

Overall dim. mm 575x815x767 h without wheels

*Wheel plate thickness

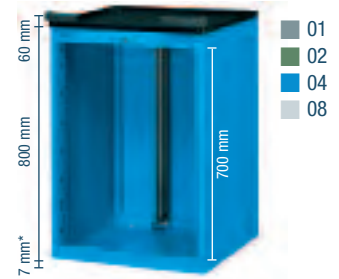

01
02
04
08

ORD. NO.

F DD 0570 00 04

Overall dim. mm 575x815x867 h without wheels

*Wheel plate thickness

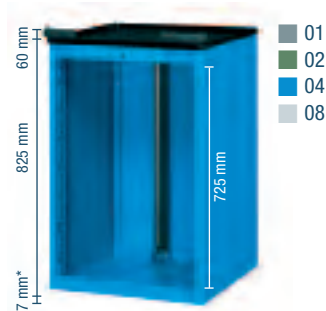

01
02
04
08

ORD. NO.

F DD 0572 00 04

Overall dim. mm 575x815x892 h without wheels

*Wheel plate thickness

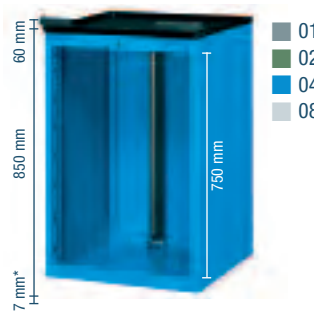

01
02
04
08

ORD. NO.

F DD 0575 00 04

Overall dim. mm 575x815x917 h without wheels

*Wheel plate thickness

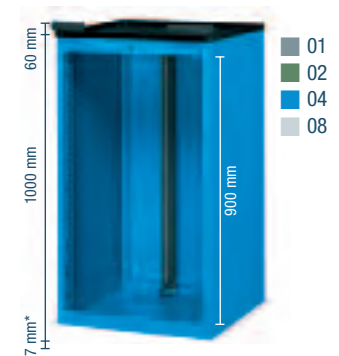

01
02
04
08

ORD. NO.

F DD 0590 00 04

Overall dim. mm 575x815x1067 h without wheels

*Wheel plate thickness



01
02
04
08

ORD. NO.

F DD 0020 00 04

Overall dim. mm 575x815x675 h without wheels

Prepared for wheels Ø mm 100 125 150



01
02
04
08

ORD. NO.

F DD 0030 00 04

Overall dim. mm 575x815x675 h without wheels

Prepared for wheels Ø mm 100 125 150



The single drawer opening system
ORD. NO. F DD 9400 00 07 must be
applied to all drawers of mobile
cabinets.

Other types of wheels see page A52



SWIVEL WHEEL WITH BRAKE IN STANDARD RUBBER

ORD. NO.	Ø mm	CABINET LOAD CAPACITY	C mm
C RG DAC11 100	100	160 kg	130
C RG DAC12 125	125	235 kg	160
C RG DAC13 150	150	280 kg	185



FIXED WHEEL IN STANDARD RUBBER

ORD. NO.	Ø mm	CABINET LOAD CAPACITY	C mm
C RG BAC11 100	100	160 kg	130
C RG BAC12 125	125	235 kg	160
C RG BAC13 150	150	280 kg	185



SWIVEL WHEEL WITH BRAKE IN NYLON

ORD. NO.	Ø mm	CABINET LOAD CAPACITY	C mm
C RN DAD10 100	100	310 kg	130
C RN DAD11 125	125	475 kg	160



FIXED WHEEL IN NYLON

ORD. NO.	Ø mm	CABINET LOAD CAPACITY	C mm
C RN BAD10 100	100	310 kg	130
C RN BAD11 125	125	475 kg	160

CABINETS SERIES STANDARD B

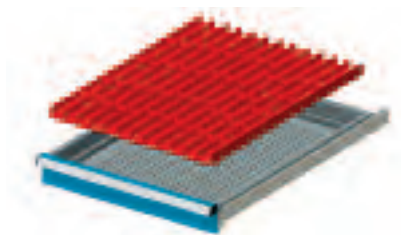

ORD. NO.	FOR FRONT HEIGHTS
----------	-------------------

F FH 8605 01 00	50-300
------------------------	--------

Set including:

12 Troughs	4 grooves
50 Plain partitions	36 mm

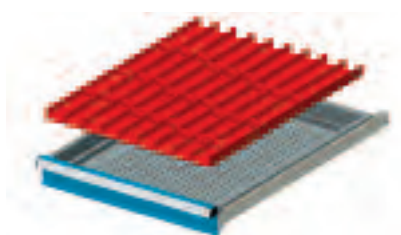

ORD. NO.	FOR FRONT HEIGHTS
----------	-------------------

F FH 8605 06 00	50-300
------------------------	--------

Set including:

12 Troughs	3 grooves
27 Plain partitions	47 mm

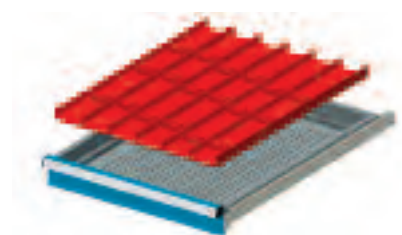

ORD. NO.	FOR FRONT HEIGHTS
----------	-------------------

F FH 8605 04 00	50-300
------------------------	--------

Set including:

12 Troughs	2 grooves
18 Plain partitions	73 mm

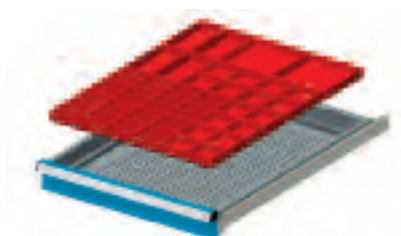

ORD. NO.	FOR FRONT HEIGHTS
----------	-------------------

F FH 8605 16 00	50
F FH 8607 16 00	75

Set including:

16 Plastic boxes with 2 compartments	75x75 mm
16 Plastic boxes	75x75 mm
4 Plastic boxes	150x75 mm
2 Plastic boxes	150x150 mm

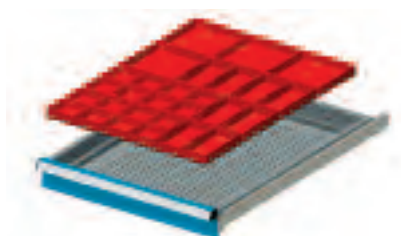

ORD. NO.	FOR FRONT HEIGHTS
----------	-------------------

F FH 8605 17 00	50
F FH 8607 17 00	75

Set including:

16 Plastic boxes	75x75 mm
8 Plastic boxes	150x75 mm
4 Plastic boxes	150x150 mm

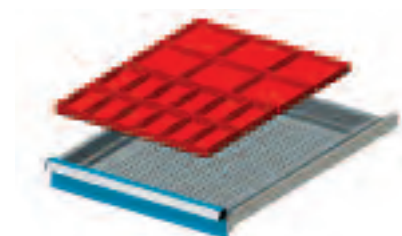

ORD. NO.	FOR FRONT HEIGHTS
----------	-------------------

F FH 8605 18 00	50
F FH 8607 18 00	75
F FH 8610 18 00	100-125

Set including:

12 Plastic boxes	150x75 mm
6 Plastic boxes	150x150 mm

INFO ■



■ Partitioning material: see page **A180**

www.famispa.com



LENGTH = 564 mm DEPTH = 726 mm (27x36 Eh)

CABINETS SERIES STANDARD B

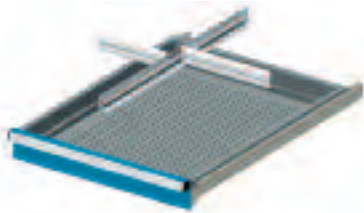

ORD. NO.	FOR FRONT HEIGHTS
F FH 8605 07 00	50
F FH 8607 07 00	75
F FH 8610 07 00	100-125
F FH 8615 07 00	150-175
F FH 8620 07 00	200-250
F FH 8630 07 00	300
Set including:	
1 Slotted partition	610 mm
1 Plain partition	200 mm
1 Plain partition	251 mm

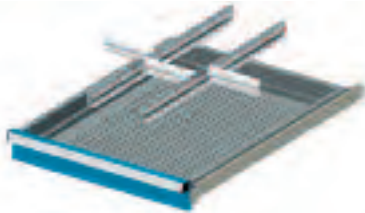

ORD. NO.	FOR FRONT HEIGHTS
F FH 8605 08 00	50
F FH 8607 08 00	75
F FH 8610 08 00	100-125
F FH 8615 08 00	150-175
F FH 8620 08 00	200-250
F FH 8630 08 00	300
Set including:	
2 Slotted partitions	610 mm
3 Plain partitions	149 mm

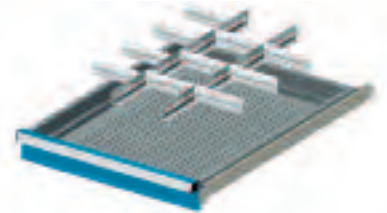

ORD. NO.	FOR FRONT HEIGHTS
F FH 8605 09 00	50
F FH 8607 09 00	75
F FH 8610 09 00	100-125
F FH 8615 09 00	150-175
F FH 8620 09 00	200-250
Set including:	
2 Slotted partitions	610 mm
10 Plain partitions	149 mm

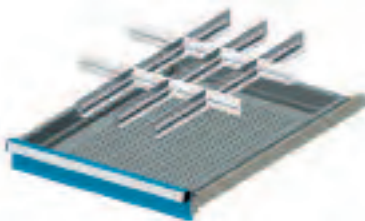

ORD. NO.	FOR FRONT HEIGHTS
F FH 8605 10 00	50
F FH 8607 10 00	75
F FH 8610 10 00	100-125
F FH 8615 10 00	150-175
Set including:	
3 Slotted partitions	610 mm
6 Plain partitions	98 mm
2 Plain partitions	149 mm

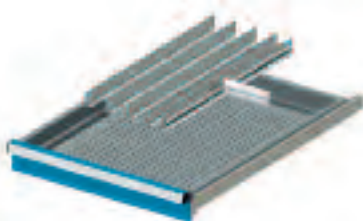

ORD. NO.	FOR FRONT HEIGHTS
F FH 8605 12 00	50
F FH 8607 12 00	75
F FH 8610 12 00	100-125
F FH 8615 12 00	150-175
F FH 8620 12 00	200-250
Set including:	
1 Slotted partition	610 mm
4 Plain partitions	610 mm
1 Plain partition	149 mm

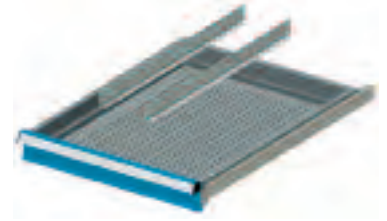

ORD. NO.	FOR FRONT HEIGHTS
F FH 8605 13 00	50
F FH 8607 13 00	75
F FH 8610 13 00	100-125
F FH 8615 13 00	150-175
F FH 8620 13 00	200-250
F FH 8630 13 00	300
Set including:	
2 Plain partitions	610 mm

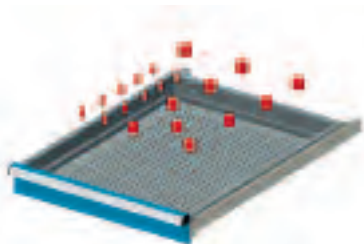

ORD. NO.	FOR FRONT HEIGHTS
F FH 8605 15 00	500-300
Set including:	
10 Cutter holders	Ø 12,2 mm
5 Cutter holders	Ø 26,5 mm
5 Cutter holders	Ø 31,2 mm

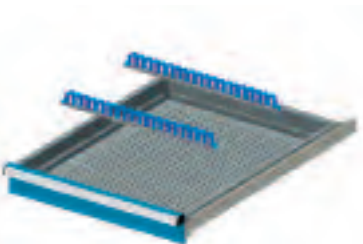

ORD. NO.	FOR FRONT HEIGHTS
F FH 8605 19 00	500-300
Set including:	
2 Multi-purpose supports	440 mm

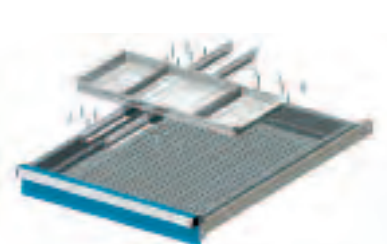

ORD. NO.	FOR FRONT HEIGHTS
F FH 8610 14 00	100
F FH 8615 14 00	150
F FH 8620 14 00	200-250
Set including:	
2 Plain partitions	610 mm
20 Location pins	27 mm
1 Sliding drawer	470 mm

■ INFO

www.famispa.com

■ Partitioning material: see page A180

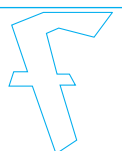



ORD. NO. F AG 1040 S1 51
RAL 5012+7000



ORD. NO. F AG L134 03 50
RAL 7035+5012

36 EH (600 mm)

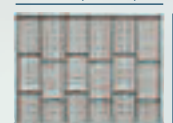

27 EH (447 mm)

FLOOR FIXING SET



2x

- 2 "HILTI" plugs for concrete floors \geq to classes B25/RBK250/MPA 25 N/mm²
- Recommended traction of the plug: 2.9 KN
- Plug diameter: \varnothing 6 mm

ORD. NO. F AG 9204 00 99

CABINET FLOOR FIXING SET

- Pair of spare galvanised brackets
- \varnothing 6 mm hole



ORD. NO. F AG 9200 00 99

CABINET

ORD. NO.

F AG 1040 S1 51

Complete with 10 drawers,
1 rubber cover top with 4 edges

Dimensions mm 717x573x1000 h

Tools and partitioning material
excluded

CABINET WITH WHEELS

ORD. NO.

F AG L134 03 50

Complete with 8 drawers

Dimensions mm 717x574x1121 h

RAL 7000 F.01

RAL 6011 F.02

RAL 5012 F.04

RAL 7035 F.08

SUPPLEMENTARY PARTS ■



- Partitioning material: see page A80-A81



- **Spare key.** Always indicate the number on the cylinder lock of the key to be replaced.

ORD. NO. R CSC 0002 00

- **Master key.** This type of key opens all the 45 and 46 series locks.

ORD. NO. R CSC 0001 00



LENGTH = 717 mm DEPTH = 573 mm (36x27 Eh)

CABINETS SERIES STANDARD GE

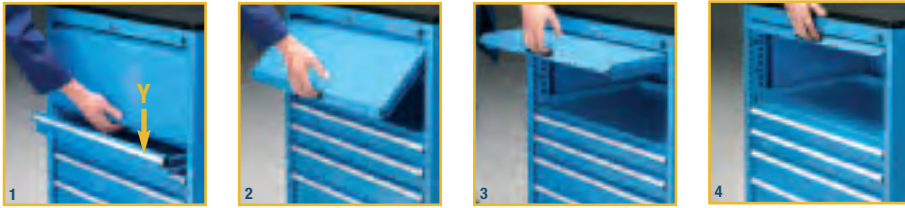

The door can be closed by the edge of the lower drawer handle (ref. Y)

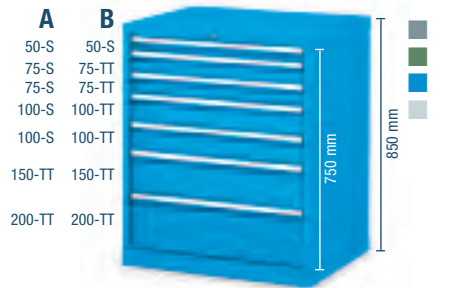

ORD. NO.	TYPE
F AG 1034 01 04	A
F AG 1034 51 04	B
Cabinet with 7 drawers	
Dim. mm 717x573x850 h Central lock	

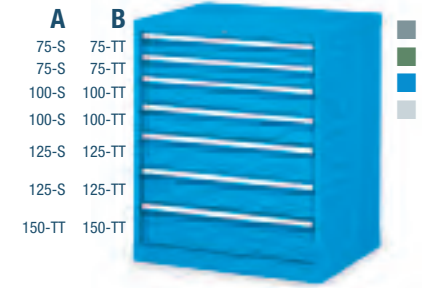

ORD. NO.	TYPE
F AG 1034 02 04	A
F AG 1034 52 04	B
Cabinet with 7 drawers	
Dim. mm 717x573x850 h Central lock	

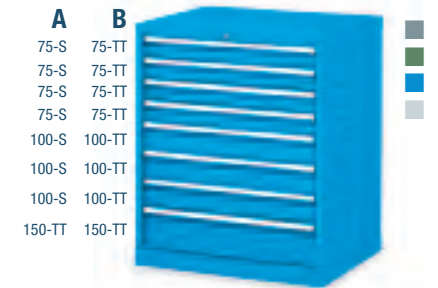

ORD. NO.	TYPE
F AG 1034 03 04	A
F AG 1034 53 04	B
Cabinet with 8 drawers	
Dim. mm 717x573x850 h Central lock	

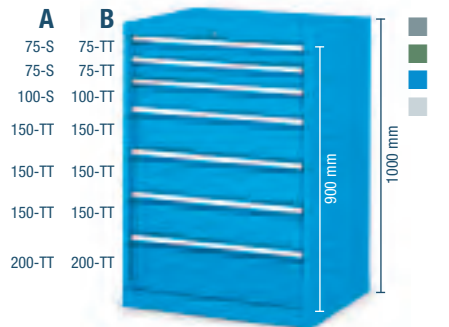

ORD. NO.	TYPE
F AG 1040 03 04	A
F AG 1040 53 04	B
Cabinet with 7 drawers	
Dim. mm 717x573x1000 h Central lock	

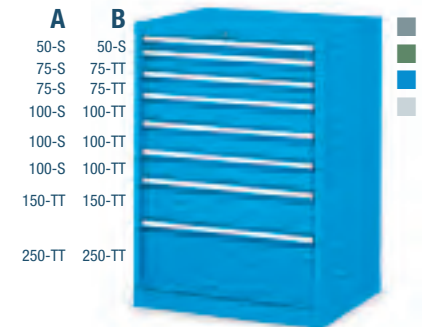

ORD. NO.	TYPE
F AG 1040 10 04	A
F AG 1040 60 04	B
Cabinet with 8 drawers	
Dim. mm 717x573x1000 h Central lock	

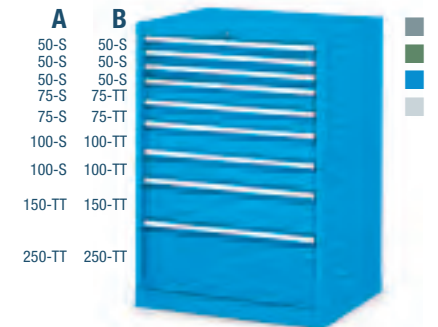

ORD. NO.	TYPE
F AG 1040 05 04	A
F AG 1040 55 04	B
Cabinet with 9 drawers	
Dim. mm 717x573x1000 h Central lock	

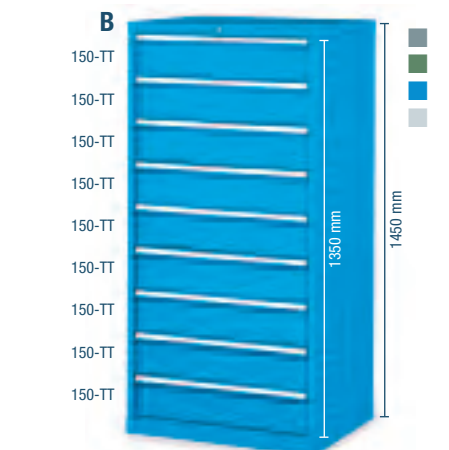

ORD. NO.	TYPE
-	-
F AG 1058 01 04	B
Cabinet with 9 drawers	
Dim. mm 717x573x1450 h Central lock	



ORD. NO.	TYPE
F AG 1058 04 04	A
F AG 1058 54 04	B
Cabinet with 9 drawers	
Dim. mm 717x573x1450 h Central lock	

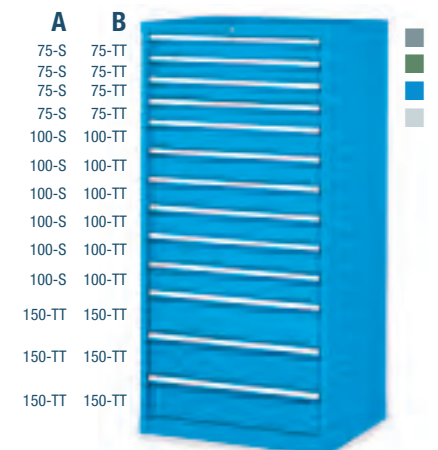

ORD. NO.	TYPE
F AG 1058 03 04	A
F AG 1058 53 04	B
Cabinet with 13 drawers	
Dim. mm 717x573x1450 h Central lock	

CABINETS SERIES STANDARD GE



- | A | B |
|--------|--------|
| 75-S | 75-TT |
| 75-S | 75-TT |
| 100-S | 100-TT |
| 100-S | 100-TT |
| 125-S | 125-TT |
| 125-S | 125-TT |
| 150-TT | 150-TT |



- | A | B |
|--------|--------|
| 50-S | 50-S |
| 75-S | 75-TT |
| 75-S | 75-TT |
| 100-S | 100-TT |
| 100-S | 100-TT |
| 150-TT | 150-TT |
| 200-TT | 200-TT |



- | A | B |
|--------|--------|
| 75-S | 75-TT |
| 75-S | 75-TT |
| 75-S | 75-TT |
| 75-S | 75-TT |
| 100-S | 100-TT |
| 100-S | 100-TT |
| 100-S | 100-TT |
| 100-S | 100-TT |
| 150-TT | 150-TT |

•ORD. NO.	TYPE
F AG S134 02 04	A
F AG S134 52 04	B
Cabinet with 7 drawers with Ø 125 mm wheels in elastic rubber	
Cabinet load capacity: 420 kg	
Dimensions mm 717x574x1077 h	
Central lock	

•ORD. NO.	TYPE
F AG S134 01 04	A
F AG S134 51 04	B
Cabinet with 7 drawers with Ø 125 mm wheels in elastic rubber	
Cabinet load capacity: 420 kg	
Dimensions mm 717x574x1077 h	
Central lock	

•ORD. NO.	TYPE
F AG S134 03 04	A
F AG S134 53 04	B
Cabinet with 8 drawers with Ø 125 mm wheels in elastic rubber	
Cabinet load capacity: 420 kg	
Dimensions mm 717x574x1077 h	
Central lock	



- | A | B |
|--------|--------|
| 100-S | 100-TT |
| 100-S | 100-TT |
| 100-S | 100-TT |
| 150-TT | 150-TT |
| 150-TT | 150-TT |
| 300-TT | 300-TT |



- | A | B |
|--------|--------|
| 75-S | 75-TT |
| 75-S | 75-TT |
| 100-S | 100-TT |
| 150-TT | 150-TT |
| 150-TT | 150-TT |
| 150-TT | 150-TT |
| 200-TT | 200-TT |

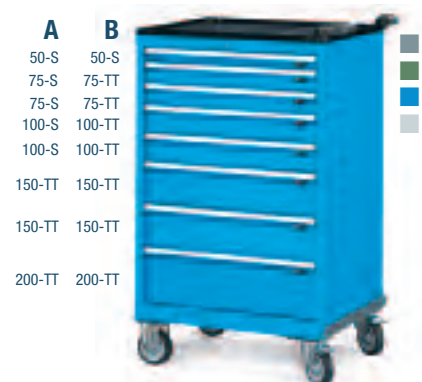

- | A | B |
|--------|--------|
| 50-S | 50-S |
| 75-S | 75-TT |
| 75-S | 75-TT |
| 100-S | 100-TT |
| 100-S | 100-TT |
| 150-TT | 150-TT |
| 150-TT | 150-TT |
| 200-TT | 200-TT |

•ORD. NO.	TYPE
F AG S140 01 04	A
F AG S140 51 04	B
Cabinet with 6 drawers with Ø 125 mm wheels in elastic rubber	
Cabinet load capacity: 420 kg	
Dimensions mm 717x574x1227 h	
Central lock	

•ORD. NO.	TYPE
F AG S140 02 04	A
F AG S140 52 04	B
Cabinet with 6 drawers with Ø 125 mm wheels in elastic rubber	
Cabinet load capacity: 420 kg	
Dimensions mm 717x574x1227 h	
Central lock	

•ORD. NO.	TYPE
F AG S140 03 04	A
F AG S140 53 04	B
Cabinet with 8 drawers with Ø 125 mm wheels in elastic rubber	
Cabinet load capacity: 420 kg	
Dimensions mm 717x574x1227 h	
Central lock	

- RAL 7000 F.01
- RAL 6011 F.02
- RAL 5012 F.04
- RAL 7035 F.08

KEY ■



■ Partitioning material: see page A80-A81

■ The handles can be fitted towards the bottom thereby reducing the height by 38 mm.



- TT = telescopic full extension (100%)
- S = normal extension (87%)
- All indicated loads are net and refer to evenly distributed weights.



LENGTH = 717 mm DEPTH = 573 mm (36x27 Eh)

CABINETS SERIES STANDARD GE

FLAP DOOR

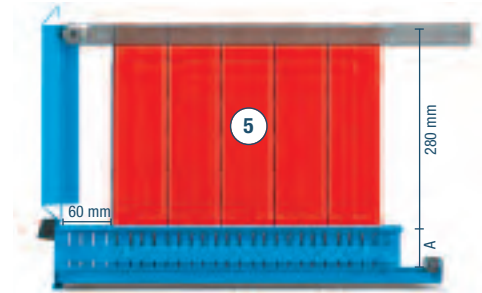
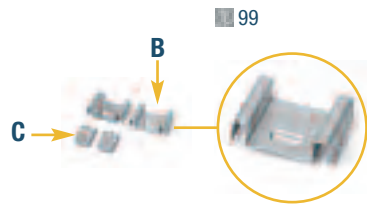
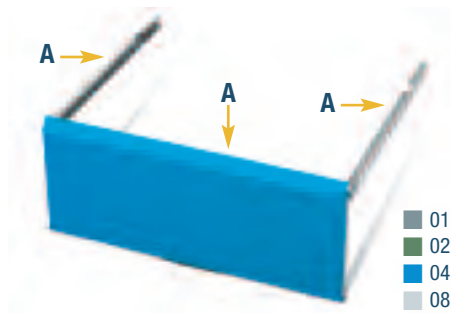

ORD. NO.	REFERENCE
F AG 9510 00 04	A+(Cx2)

Flap door with 2 guides and 2 brackets to block the door with the lower drawer locked.

ORD. NO.	REFERENCE
F DA 9698 00 99	B

The order number includes just 1 piece. 2 pieces are needed for each door.

A = usable height of the drawer
Warning: the 60 mm distance from the drawer edge should be respected only if the door has to be closed with the two brackets (Ref. C)

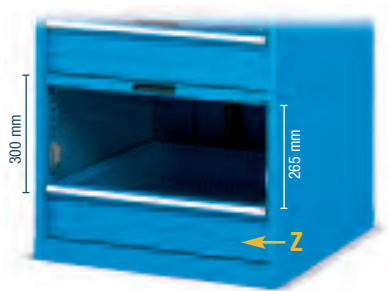

■ The two order number (ref. B) must be used when the door is fitted along with the normal or full telescopic extension drawer (ref. Z). See photo ref. 5 to understand the usable internal volume.

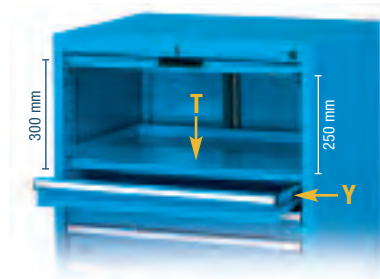

■ The two order number (ref. B) are not required when the door is fitted along with the adjustable shelf (ref. T) ORD. NO. F SR 1210 01 .. N. B. the drawer (ref. Y) must be normal extension.

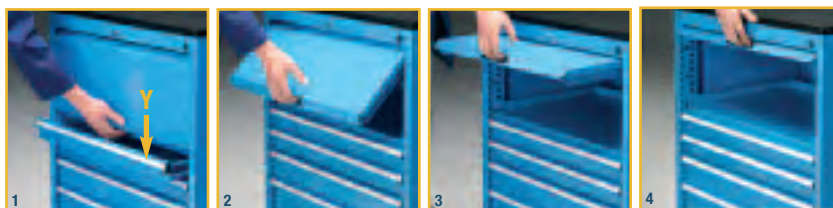

■ The door can be closed by the edge of the lower drawer handle (ref. Y)

■ INFO

RAL 7000 F.01 RAL 6011 F.02 RAL 5012 F.04 RAL 7035 F.08



www.famispa.com

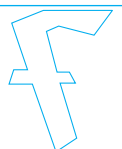

CABINETS SERIES STANDARD GE

EMPTY CABINETS

ORD. NO.	USABLE HEIGHT mm	LOAD CAPACITY kg	DIMENSIONS mm
F AG 1034 00 04	750	3100	717x573x850 h
F AG 1040 00 04	900	3100	717x573x1000 h
F AG 1058 00 04	1350	3100	717x573x1450 h

■ 01 ■ 02 ■ 04 ■ 08



■ The cabinets must be secured to the floor or to the wall. If the cabinets are stacked they must be secured to the wall and their load capacity must be divided by 2. Further information for fixing set see page A60.

SPARE LOCK

ORD. NO. R CSR 0003 00
for cabinet

FULL TELESCOPIC EXTENSION DRAWERS (TT)

ORD. NO.	FRONT HEIGHT mm	LOAD CAPACITY kg	USABLE DIMENSIONS mm
F FG 1107 00 04	75	200	600x447x54 h
F FG 1110 00 04	100	200	600x447x79 h
F FG 1112 00 04	125	200	600x447x104 h
F FG 1115 00 04	150	200	600x447x129 h
F FG 1120 00 04	200	200	600x447x179 h
F FG 1125 00 04	250	200	600x447x229 h
F FG 1130 00 04	300	200	600x447x279 h

Full telescopic extension (100%)



■ Partitioning material: see page A80-A81

NORMAL EXTENSION DRAWERS (S)

ORD. NO.	FRONT HEIGHT mm	LOAD CAPACITY kg	USABLE DIMENSIONS mm
F FG 1005 00 04	50	60	600x447x36
F FG 1007 00 04	75	80	600x447x61
F FG 1010 00 04	100	100	600x447x86
F FG 1012 00 04	125	100	600x447x111

Normal extension (87%)



FULL TELESCOPIC EXTENSION SHELVES (PE-TT)

ORD. NO.	SIDE HEIGHT mm	LOAD CAPACITY kg	USABLE DIMENSIONS mm
F FG 8110 00 04	-	200	610x459

Full telescopic extension (100%)

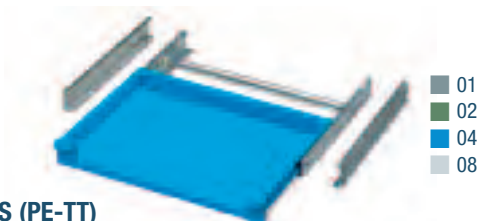

NORMAL EXTENSION SHELVES (PE-S)

ORD. NO.	SIDE HEIGHT mm	LOAD CAPACITY kg	USABLE DIMENSIONS mm
F FG 8010 00 04	-	100	610x459

Normal extension (87%)



ADJUSTABLE SHELVES

ORD. NO.	SIDE HEIGHT mm	LOAD CAPACITY kg	USABLE DIMENSIONS mm
F SR 1210 01 04	25	150	655x460

Without extension system



CABINET TO CABINET FIXING

■ The article includes:
4 M8 nuts and bolts

ORD. NO. F AG 9202 00 99



TWO SIDED ADHESIVE TAPE

ORD. NO.

R CMV 0025 00

width 15 mm, length 50 metres



CABINET UPSTAND

ORD. NO. DIMENSIONS mm

F AG 9000 01 07 717x573x20 h

oil-resistant rubber cover top with 3 edges



LENGTH = 717 mm DEPTH = 573 mm (36x27 Eh)

CABINETS SERIES STANDARD GE



PLINTHS

ORD. NO.

F RR 0050 00 07

Plinths height 50 mm



PLINTHS FOR TRANSPALLET

ORD. NO.

F RR 0300 00 07 Plinths height 100 mm

F RR 0405 00 07 Facing piece



PLINTHS FOR FORK LIFT TRUCK

ORD. NO.

F RR 0200 00 07 Pair of plinths height 60 mm

F RR 0400 00 07 Facing piece

UPPER MDF TOP WITH RUBBER COVERING DIMENSIONS 718x573x31,5 mm H

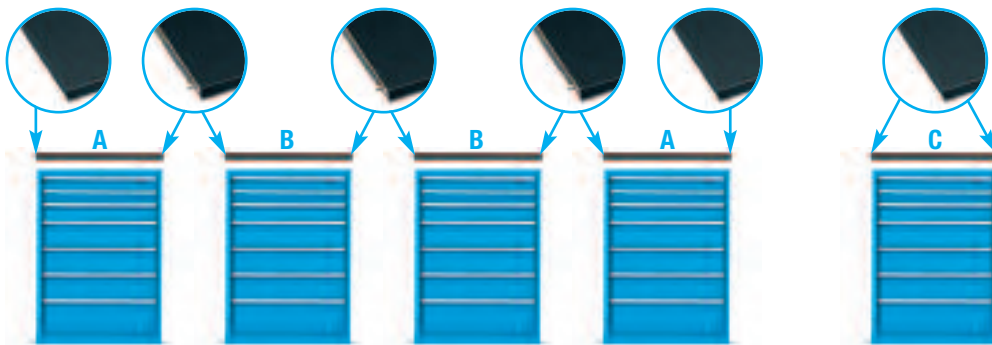

ORD. NO. F UZ 9999 00 00

Drilling of the cabinet upper shelf for the MDF top fixing.



Detail of the oil-resistant rubber

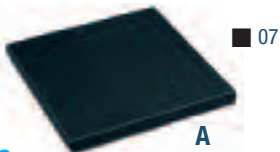

ORD. NO.

F UZ 3080 11 07

MDF top with rubber covering

Side profile

For end cabinets

Oil-resistant rubber mat



ORD. NO.

F UZ 3080 12 07

MDF top with rubber covering

No side profile

For additional central cabinets Oil-resist. rubber mat

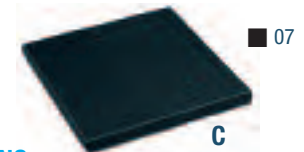

ORD. NO.

F UZ 3080 13 07

MDF top with rubber covering

2 side profiles

For single cabinet

Oil-resistant rubber mat

CABINET PREPARED FOR WHEELS

Cabinet prepared for wheels including: wheel plate, 4 edged top with oil-resistant rubber, 2 steel handles covered with shock-resistant rubber, cylinder lock with 2 keys, anti-tilt rod.



The single drawer opening system ORD. NO. F DD 9400 00 07 must be applied to all drawers of mobile cabinets.

01
02
04
08

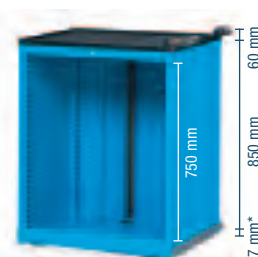

ORD. NO.

F AG 0134 00 04

Overall dim. mm 792x574x917 h without wheels

*Wheel plate thickness

01
02
04
08

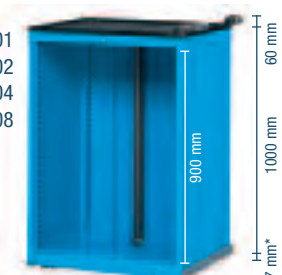

ORD. NO.

F AG 0140 00 04

Overall dim. mm 792x574x1067 h without wheels

*Wheel plate thickness

Other types of wheels: see page A52

ELASTIC RUBBER SWIVEL WHEEL WITH BRAKE	ORD. NO.	Ø mm	CABINET LOAD CAPACITY	C mm
	C RG DCE15 125	125	420 kg	160

ELASTIC RUBBER FIXED WHEEL	ORD. NO.	Ø mm	CABINET LOAD CAPACITY	C mm
	C RG BCE15 125	125	420 kg	160

NYLON SWIVEL WHEEL WITH BRAKE	ORD. NO.	Ø mm	CABINET LOAD CAPACITY	C mm
	C RN DAD10 100	100	255 kg	130
	C RN DAD11 125	125	420 kg	160

NYLON FIXED WHEEL	ORD. NO.	Ø mm	CABINET LOAD CAPACITY	C mm
	C RN BAD10 100	100	255 kg	130
	C RN BAD11 125	125	420 kg	160

CABINETS SERIES STANDARD GE

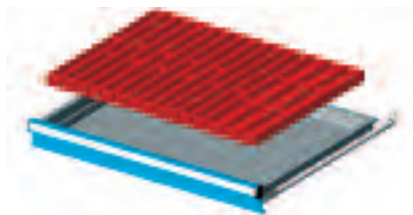
**ORD. NO.**

FOR FRONT HEIGHTS

F FH 1005 10 00

50-300

Set including:

9 Troughs	4 grooves
36 Plain partitions	36 mm
3 Troughs	3 grooves
12 Plain partitions	47 mm

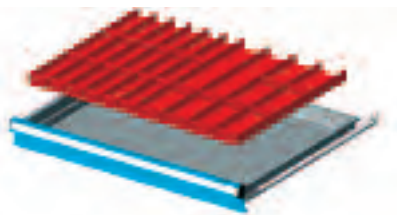
**ORD. NO.**

FOR FRONT HEIGHTS

F FH 1005 13 00

50-300

Set including:

6 Troughs	3 grooves
18 Plain partitions	47 mm
6 Troughs	2 grooves
12 Plain partitions	73 mm

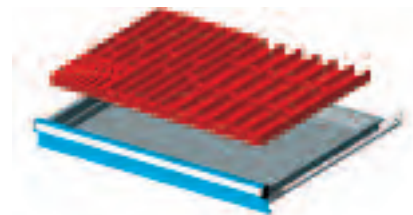
**ORD. NO.**

FOR FRONT HEIGHTS

F FH 1005 15 00

50-300

Set including:

5 Troughs	4 grooves
20 Plain partitions	36 mm
6 Troughs	3 grooves
20 Plain partitions	47 mm
1 Allen key tray	150x150 mm

**EXAMPLE INCLUDING:****ORD. NO.****F AG ZA01 00 01**

4 cabinets complete with drawers and retractable shelves

Dimensions mm 1435x573x1700 h

Tools and partitioning material excluded

■ RAL 7000

RAL 7000 F.01

RAL 6011 F.02

RAL 5012 F.04

RAL 7035 F.08

INFO ■■ Partitioning material: see page **A180**www.famispa.com

LENGTH = 717 mm DEPTH = 573 mm (36x27 Eh)

CABINETS SERIES STANDARD GE

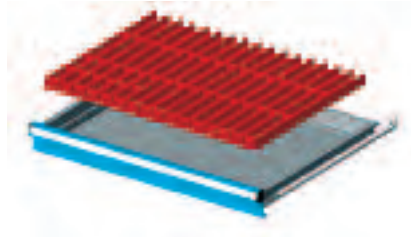

ORD. NO.	FOR FRONT HEIGHTS
F FH 1005 21 00	50-300
Set including:	
12 Troughs	4 grooves
16 Plain partitions	36 mm

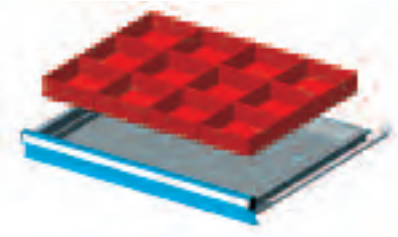

ORD. NO.	FOR FRONT HEIGHTS
F FH 1005 09 00	50
F FH 1007 09 00	75
F FH 1010 09 00	100-125
Set including:	
12 Plastic boxes	150x150 mm

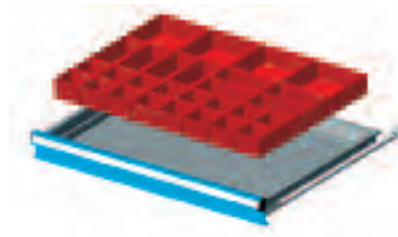

ORD. NO.	FOR FRONT HEIGHTS
F FH 1005 18 00	50
F FH 1007 18 00	75
Set including:	
16 Plastic boxes	75x75 mm
8 Plastic boxes	150x75 mm
4 Plastic boxes	150x150 mm

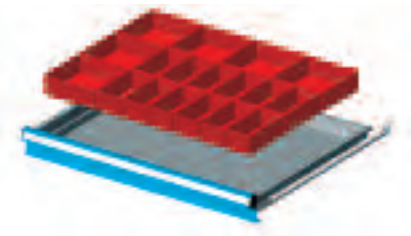

ORD. NO.	FOR FRONT HEIGHTS
F FH 1005 16 00	50
F FH 1007 16 00	75
F FH 1010 16 00	100-125
Set including:	
12 Plastic boxes	150x75 mm
6 Plastic boxes	150x150 mm

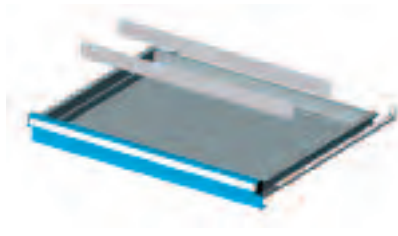

ORD. NO.	FOR FRONT HEIGHTS
F FH 1005 01 00	50
F FH 1007 01 00	75
F FH 1010 01 00	100-125
F FH 1015 01 00	150-175
F FH 1020 01 00	200-250
F FH 1030 01 00	300
Set including:	
2 Plain partitions	610 mm

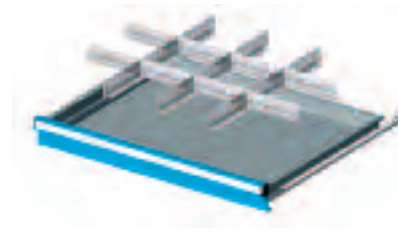

ORD. NO.	FOR FRONT HEIGHTS
F FH 1005 03 00	50
F FH 1007 03 00	75
F FH 1010 03 00	100-125
F FH 1015 03 00	150-175
F FH 1020 03 00	200-250
Set including:	
3 Slotted partitions	455 mm
8 Plain partitions	149 mm



ORD. NO.	FOR FRONT HEIGHTS
F FH 1005 06 00	50
F FH 1007 06 00	75
F FH 1010 06 00	100-125
F FH 1015 06 00	150-175
Set including:	
5 Slotted partitions	455 mm
12 Plain partitions	98 mm

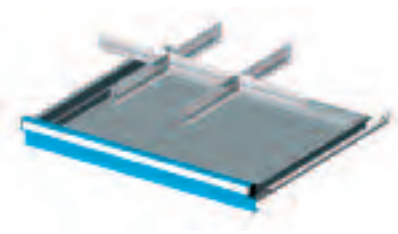

ORD. NO.	FOR FRONT HEIGHTS
F FH 1005 05 00	50
F FH 1007 05 00	75
F FH 1010 05 00	100-125
F FH 1015 05 00	150-175
F FH 1020 05 00	200-250
F FH 1030 05 00	300
Set including:	
2 Slotted partitions	455 mm
3 Plain partitions	200 mm

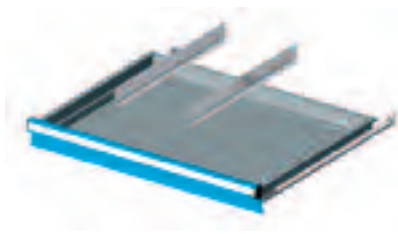

ORD. NO.	FOR FRONT HEIGHTS
F FH 8405 13 00	50
F FH 8407 13 00	75
F FH 8410 13 00	100-125
F FH 8415 13 00	150-175
F FH 8420 13 00	200-250
Set including:	
2 Plain partitions	455 mm

■ INFO

www.famispa.com

■ Partitioning material: see page A180

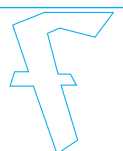



ORD. NO. F AG L234 S1 50
RAL 7035+5012

ORD. NO. F AG 2040 S1 56
RAL 7035+7000

36 EH (600 mm)

36 EH (600 mm)

FLOOR FIXING SET



2x

- 2 "HILTI" plugs for concrete floors \geq to classes B25/RBK250/MPa 25 N/mm²
- Recommended traction of the plug: 2.9 KN
- Plug diameter: \varnothing 6 mm

ORD. NO. F AG 9204 00 99

CABINET FLOOR FIXING SET

- Pair of spare galvanised brackets
- \varnothing 6 mm hole



ORD. NO. F AG 9200 00 99

CABINETS

ORD. NO.

F AG 2040 S1 56

Complete with 9 drawers,
1 rubber cover top with 3 edges

Dimensions mm 717x726x1020 h

Tools and partitioning material
excluded

CABINET WITH WHEELS

ORD. NO.

F AG L234 S1 50

Complete with 4 drawers,
1 adjustable shelf, 1 flap door,
1 rubber cover MDF top,
1 perforated back panel

Dim. mm 717x802x1091/1791 h

Hooks and tools excluded

RAL 7000 F.01

RAL 6011 F.02

RAL 5012 F.04

RAL 7035 F.08

SUPPLEMENTARY PARTS ■



- Partitioning material: see page A96



- **Spare key.** Always indicate the number on the cylinder lock of the key to be replaced.

ORD. NO. R CSC 0002 00

- **Master key.** This type of key opens all the 45 and 46 series locks.

ORD. NO. R CSC 0001 00



LENGTH = 717 mm DEPTH = 726 mm (36x36 Eh)

CABINETS SERIES STANDARD G

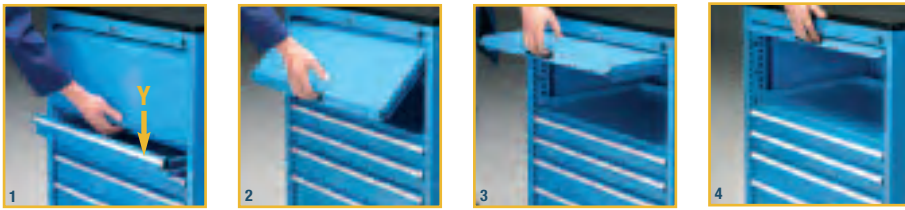

The door can be closed by the edge of the lower drawer handle (ref. Y)



ORD. NO.	TYPE
F AG 2016 01 04	A
F AG 2016 51 04	B
Cabinet with 3 drawers	
Dim. mm 717x726x400 h Central lock	

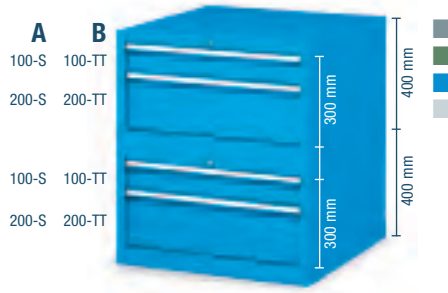

ORD. NO.	TYPE
F AG 2016 02 04	A
F AG 2016 52 04	B
Cabinet with 2+2 drawers	
Dim. mm 717x726x800 h Central lock	

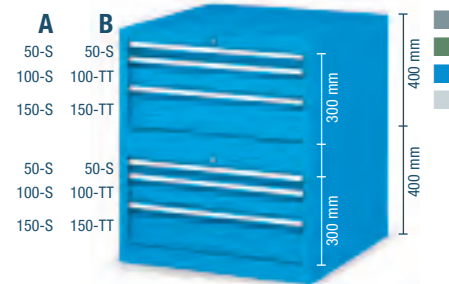

ORD. NO.	TYPE
F AG 2016 03 04	A
F AG 2016 53 04	B
Cabinet with 3+3 drawers	
Dim. mm 717x726x800 h Central lock	

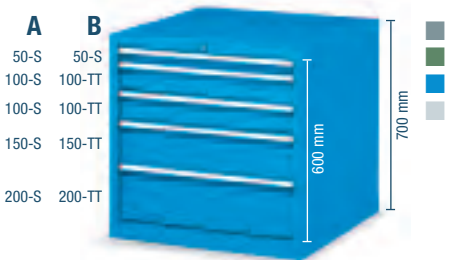

ORD. NO.	TYPE
F AG 2028 01 04	A
F AG 2028 51 04	B
Cabinet with 5 drawers	
Dim. mm 717x726x700 h Central lock	

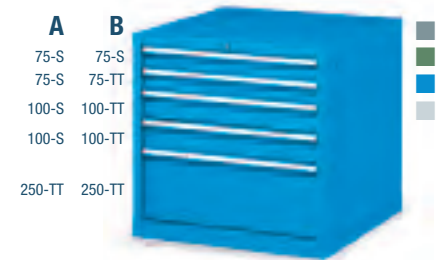

ORD. NO.	TYPE
F AG 2028 02 04	A
F AG 2028 52 04	B
Cabinet with 5 drawers	
Dim. mm 717x726x700 h Central lock	

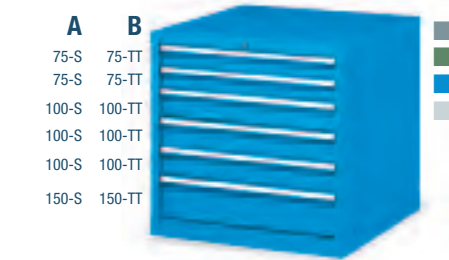

ORD. NO.	TYPE
F AG 2028 03 04	A
F AG 2028 53 04	B
Cabinet with 6 drawers	
Dim. mm 717x726x700 h Central lock	

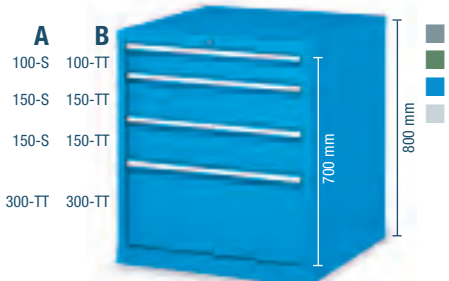

ORD. NO.	TYPE
F AG 2032 01 04	A
F AG 2032 51 04	B
Cabinet with 4 drawers	
Dim. mm 717x726x800 h Central lock	

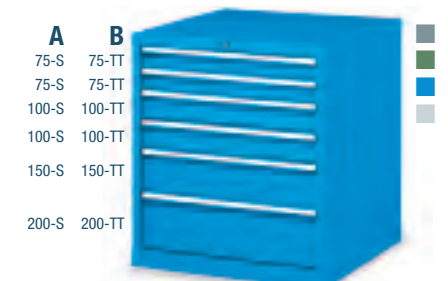

ORD. NO.	TYPE
F AG 2032 02 04	A
F AG 2032 52 04	B
Cabinet with 6 drawers	
Dim. mm 717x726x800 h Central lock	

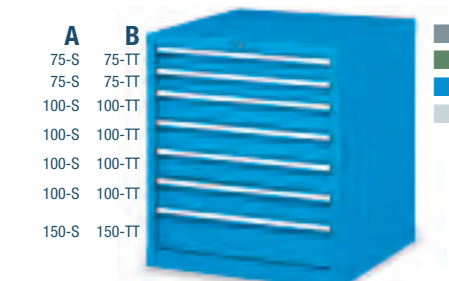

ORD. NO.	TYPE
F AG 2032 03 04	A
F AG 2032 53 04	B
Cabinet with 7 drawers	
Dim. mm 717x726x800 h Central lock	

KEY

- RAL 7000 F.01
- RAL 6011 F.02
- RAL 5012 F.04
- RAL 7035 F.08



- The cabinets must be secured to the floor or to the wall.
- TT = telescopic full extension (100%)
- S = normal extension (87%)

Partitioning material: see page A96

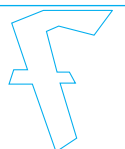

CABINETS SERIES STANDARD G

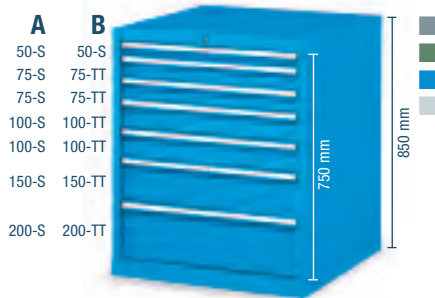

- | | |
|----------|----------|
| A | B |
| 50-S | 50-S |
| 75-S | 75-TT |
| 75-S | 75-TT |
| 100-S | 100-TT |
| 100-S | 100-TT |
| 150-S | 150-TT |
| 200-S | 200-TT |

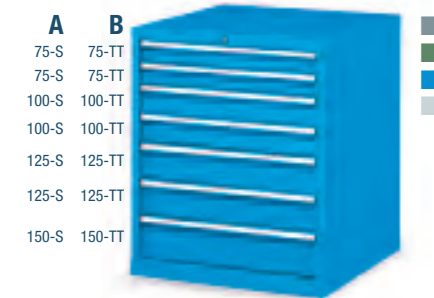

- | | |
|----------|----------|
| A | B |
| 75-S | 75-TT |
| 75-S | 75-TT |
| 100-S | 100-TT |
| 100-S | 100-TT |
| 125-S | 125-TT |
| 125-S | 125-TT |
| 150-S | 150-TT |

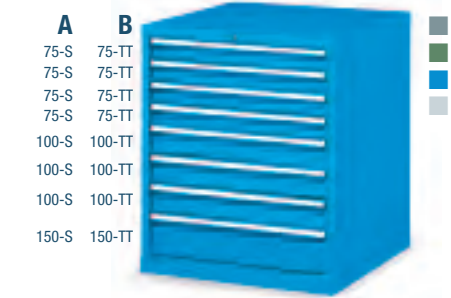

- | | |
|----------|----------|
| A | B |
| 75-S | 75-TT |
| 75-S | 75-TT |
| 75-S | 75-TT |
| 75-S | 75-TT |
| 100-S | 100-TT |
| 100-S | 100-TT |
| 100-S | 100-TT |
| 150-S | 150-TT |

ORD. NO.	TYPE
F AG 2034 01 04	A
F AG 2034 51 04	B
Cabinet with 7 drawers	
Dimensions mm 717x726x850 h	
Central lock	

ORD. NO.	TYPE
F AG 2034 02 04	A
F AG 2034 52 04	B
Cabinet with 7 drawers	
Dimensions mm 717x726x850 h	
Central lock	

ORD. NO.	TYPE
F AG 2034 03 04	A
F AG 2034 53 04	B
Cabinet with 8 drawers	
Dimensions mm 717x726x850 h	
Central lock	

EXAMPLE INCLUDING:

ORD. NO.
F AG ZA02 00 56
1 corner cabinet
6 cabinets with drawers
retractable shelves, adjustable shelves
rubber cover MDF top
Tools, containers and partitioning material excluded



■ RAL 7035 + ■ RAL 7000

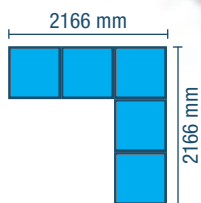

Height 1030/2000 mm

- RAL 7000 F.01
- RAL 6011 F.02
- RAL 5012 F.04
- RAL 7035 F.08

KEY ■

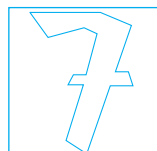

■ Partitioning material: see page **A180**

■ Partitioning material: see page **A96**

- The cabinets must be secured to the floor or to the wall.
- **TT** = telescopic full extension (100%)
- **S** = normal extension (87%)



LENGTH = 717 mm DEPTH = 726 mm (36x36 Eh)

CABINETS SERIES STANDARD G

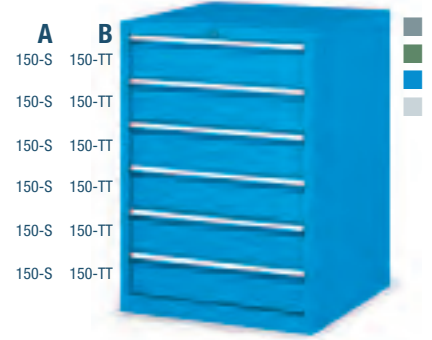
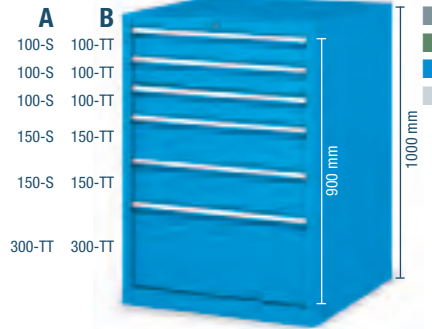
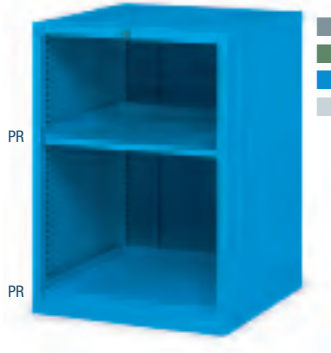

ORD. NO.	TYPE
F AG 2040 25 04	
Cabinet with 2 height adjustable shelves	
Dimensions mm 717x726x1000 h	
Central lock	

ORD. NO.	TYPE
F AG 2040 01 04	A
F AG 2040 51 04	B
Cabinet with 6 drawers	
Dim. mm 717x726x1000 h	
Central lock	

ORD. NO.	TYPE
F AG 2040 11 04	A
F AG 2040 61 04	B
Cabinet with 6 drawers	
Dim. mm 717x726x1000 h	
Central lock	

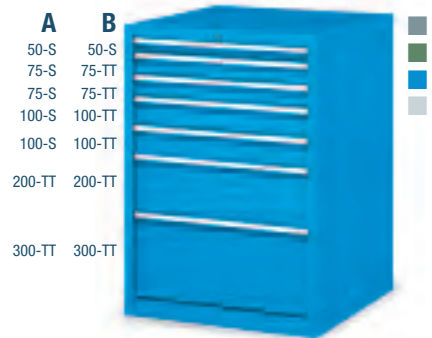
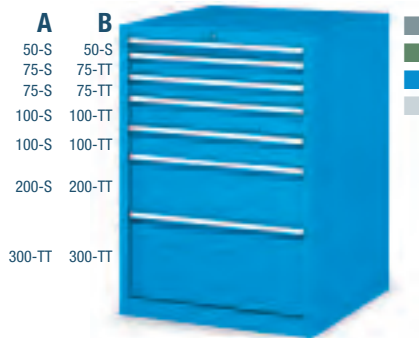
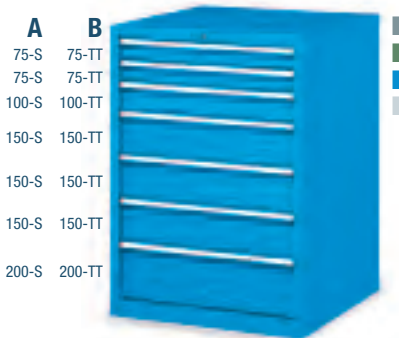

ORD. NO.	TYPE
F AG 2040 12 04	A
F AG 2040 53 04	B
Cabinet with 7 drawers	
Dim. mm 717x726x1000 h	
Central lock	

ORD. NO.	TYPE
F AG 2040 16 04	A
F AG 2040 52 04	B
Cabinet with 7 drawers	
Dim. mm 717x726x1000 h	
Central lock	

ORD. NO.	TYPE
F AG 2040 02 04	A
F AG 2040 52 04	B
Cabinet with 7 drawers	
Dim. mm 717x726x1000 h	
Central lock	

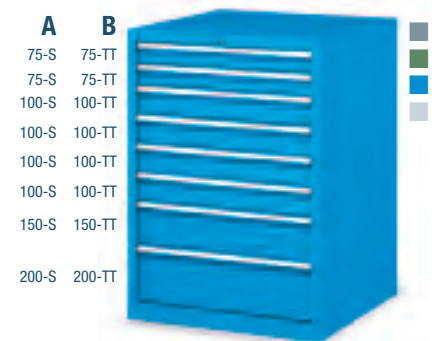
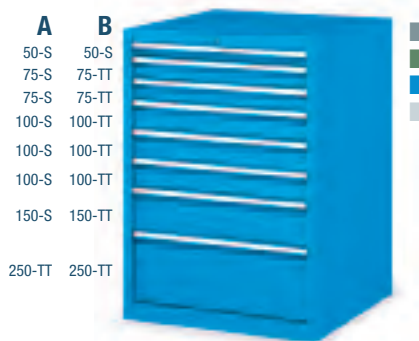
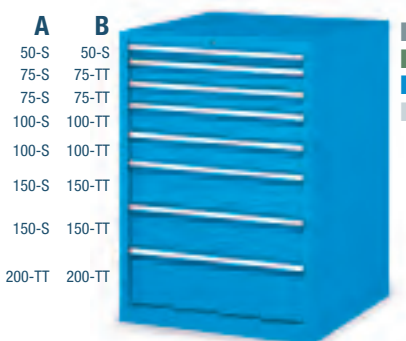

ORD. NO.	TYPE
F AG 2040 04 04	A
F AG 2040 54 04	B
Cabinet with 8 drawers	
Dim. mm 717x726x1000 h	
Central lock	

ORD. NO.	TYPE
F AG 2040 17 04	A
F AG 2040 67 04	B
Cabinet with 8 drawers	
Dim. mm 717x726x1000 h	
Central lock	

ORD. NO.	TYPE
F AG 2040 18 04	A
F AG 2040 68 04	B
Cabinet with 8 drawers	
Dim. mm 717x726x1000 h	
Central lock	

KEY

- RAL 7000 F.01
- RAL 6011 F.02
- RAL 5012 F.04
- RAL 7035 F.08



- The cabinets must be secured to the floor or to the wall.
- TT = telescopic full extension (100%)
- S = normal extension (87%)
- PR = height adjustable shelf

Partitioning material: see page A96

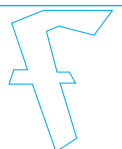

CABINETS SERIES STANDARD G

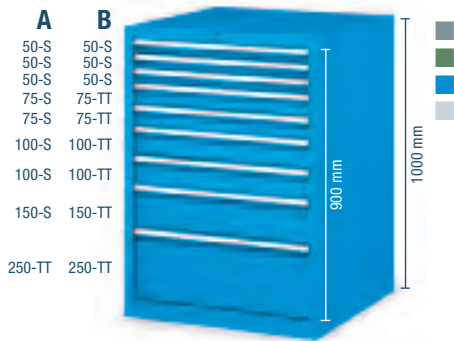

ORD. NO.	TYPE
F AG 2040 05 04	A
F AG 2040 55 04	B
Cabinet with 9 drawers	
Dim. mm 717x726x1000 h Central lock	

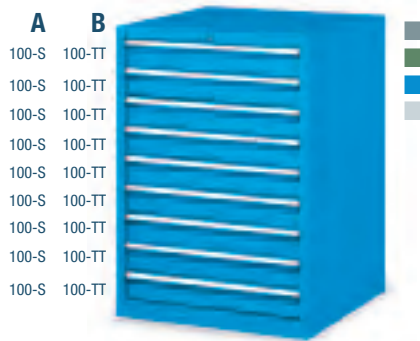

ORD. NO.	TYPE
F AG 2040 10 04	A
F AG 2040 60 04	B
Cabinet with 9 drawers	
Dim. mm 717x726x1000 h Central lock	

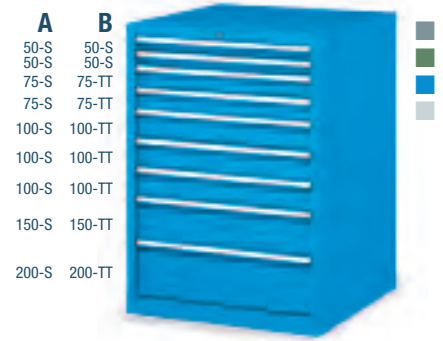

ORD. NO.	TYPE
F AG 2040 19 04	A
F AG 2040 69 04	B
Cabinet with 9 drawers	
Dim. mm 717x726x1000 h Central lock	

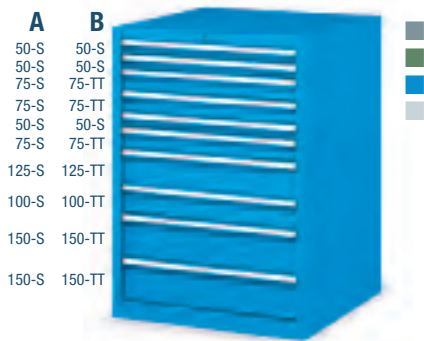

ORD. NO.	TYPE
F AG 2040 20 04	A
F AG 2040 70 04	B
Cabinet with 10 drawers	
Dim. mm 717x726x1000 h Central lock	

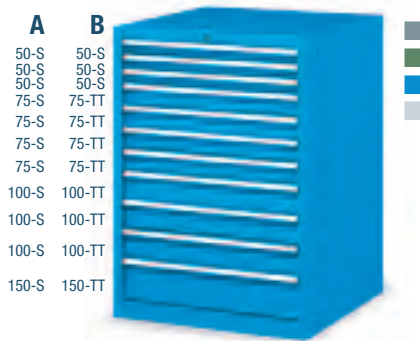

ORD. NO.	TYPE
F AG 2040 08 04	A
F AG 2040 58 04	B
Cabinet with 11 drawers	
Dim. mm 717x726x1000 h Central lock	

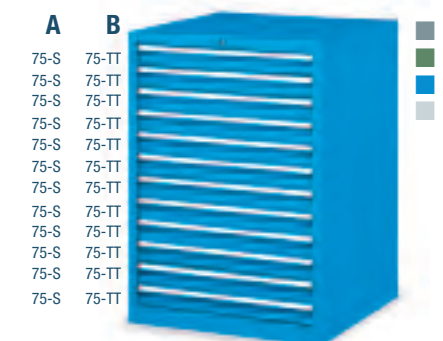

ORD. NO.	TYPE
F AG 2040 21 04	A
F AG 2040 71 04	B
Cabinet with 12 drawers	
Dim. mm 717x726x1000 h Central lock	

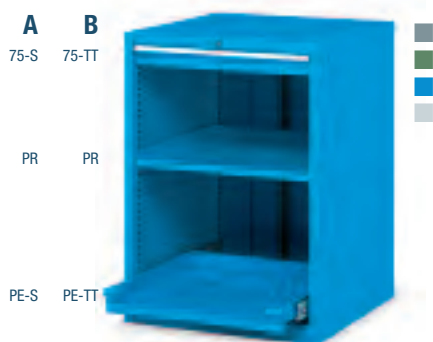

ORD. NO.	TYPE
F AG 2040 22 04	A
F AG 2040 72 04	B
Cabinet with 1 drawer, 1 retractable shelf, 1 adjustable shelf	
Dimensions mm 717x726x1000 h	
Without lock, with anti-tilt rod	

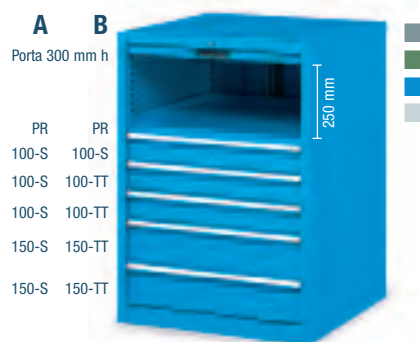

ORD. NO.	TYPE
F AG 2040 26 04	A
F AG 2040 76 04	B
Cabinet with 5 drawers	
Dimensions mm 717x726x1000 h	
Central lock	

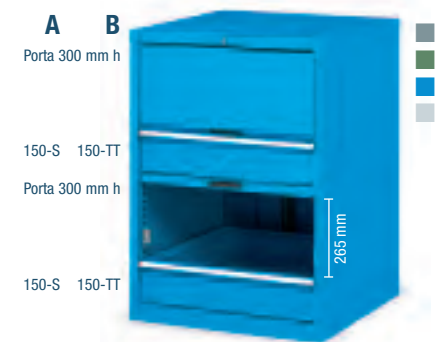

ORD. NO.	TYPE
F AG 2040 27 04	A
F AG 2040 77 04	B
Cabinet with 2 drawers	
Dimensions mm 717x726x1000 h	
Central lock	

RAL 7000 F.01 RAL 6011 F.02 RAL 5012 F.04 RAL 7035 F.08

KEY ■

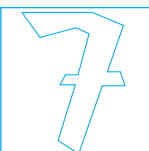

■ Single lock see page A58

■ Partitioning material: see page A96

■ The cabinets must be secured to the floor or to the wall.

- TT = telescopic full extension (100%)
- PE-TT = full telescopic retractable shelf (100%)
- S = normal extension (87%)
- PE-S = normal retractable shelf (87%)
- PR = height adjustable shelf



LENGTH = 717 mm DEPTH = 726 mm (36x36 Eh)

CABINETS SERIES STANDARD G

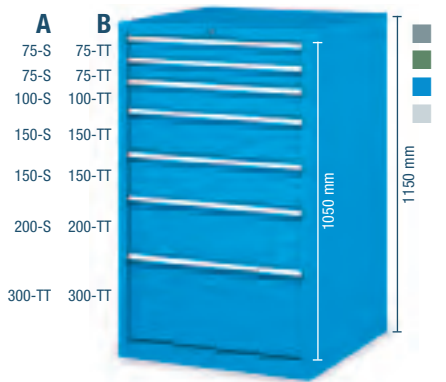

ORD. NO.	TYPE
F AG 2046 07 04	A
F AG 2046 57 04	B
Cabinet with 7 drawers	
Dim. mm 717x726x1150 h Central lock	

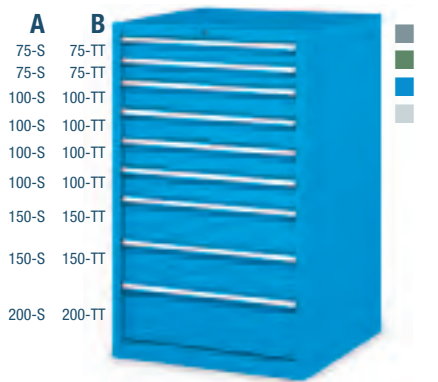

ORD. NO.	TYPE
F AG 2046 08 04	A
F AG 2046 58 04	B
Cabinet with 9 drawers	
Dim. mm 717x726x1150 h Central lock	

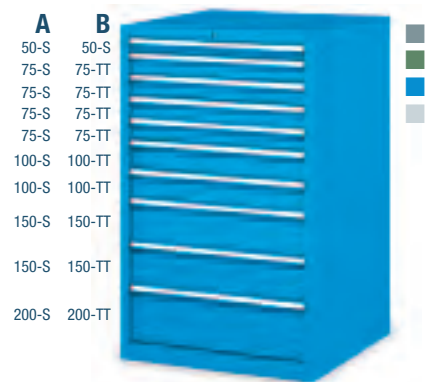

ORD. NO.	TYPE
F AG 2046 09 04	A
F AG 2046 59 04	B
Cabinet with 10 drawers	
Dim. mm 717x726x1150 h Central lock	

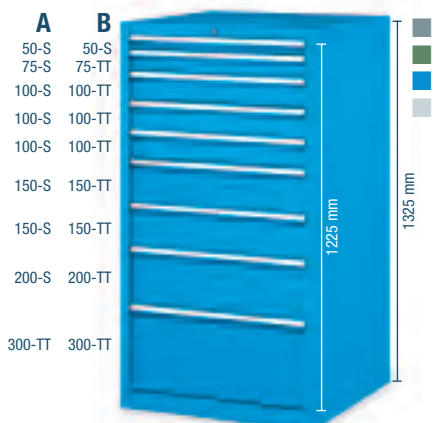

ORD. NO.	TYPE
F AG 2053 07 04	A
F AG 2053 57 04	B
Cabinet with 9 drawers	
Dim. mm 717x726x1325 h Central lock	

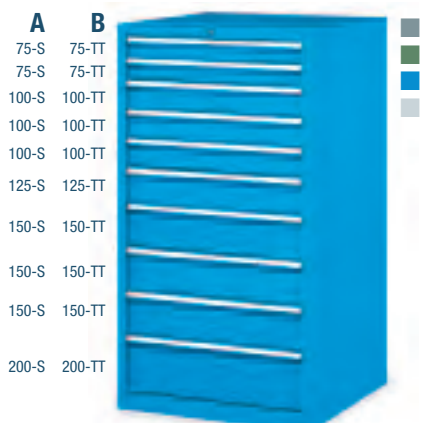

ORD. NO.	TYPE
F AG 2053 08 04	A
F AG 2053 58 04	B
Cabinet with 10 drawers	
Dim. mm 717x726x1325 h Central lock	

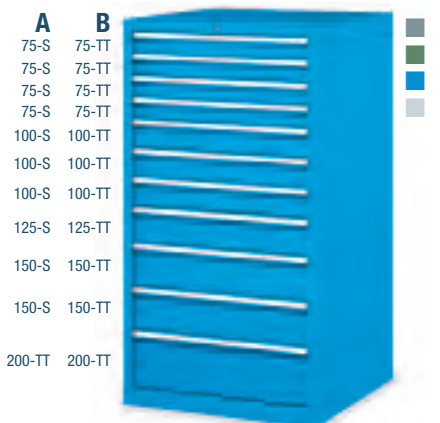

ORD. NO.	TYPE
F AG 2053 03 04	A
F AG 2053 53 04	B
Cabinet with 11 drawers	
Dim. mm 717x726x1325 h Central lock	

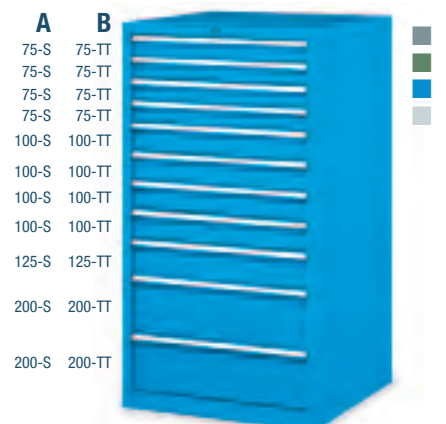

ORD. NO.	TYPE
F AG 2053 09 04	A
F AG 2053 59 04	B
Cabinet with 11 drawers	
Dim. mm 717x726x1325 h Central lock	

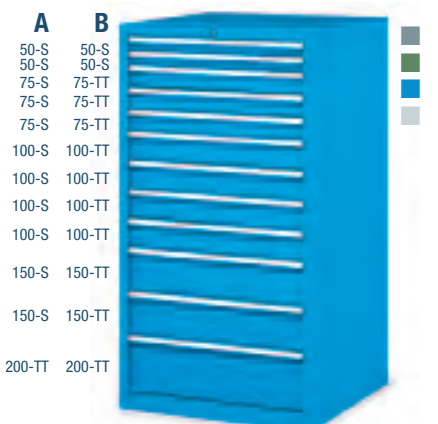

ORD. NO.	TYPE
F AG 2053 05 04	A
F AG 2053 55 04	B
Cabinet with 12 drawers	
Dim. mm 717x726x1325 h Central lock	



ORD. NO.	TYPE
F AG 2053 10 04	A
F AG 2053 60 04	B
Cabinet with 3 retractable shelves	
Dim. mm 717x726x1325 h Without lock, with anti-tilt rod	

KEY



- TT = telescopic full extension (100%)
- PE-TT = full telescopic retractable shelf (100%)
- S = normal extension (87%)
- PE-S = normal retractable shelf (87%)

RAL 7000 F.01

RAL 6011 F.02

RAL 5012 F.04

RAL 7035 F.08

■ The cabinets must be secured to the floor or to the wall.

■ Partitioning material: see page A96

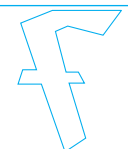

CABINETS SERIES STANDARD G



ORD. NO.	TYPE
F AG 2058 07 04	A
F AG 2058 57 04	B
Cabinet with 9 drawers	
Dim. mm 717x726x1450 h Central lock	



ORD. NO.	TYPE
F AG 2058 08 04	A
F AG 2058 58 04	B
Cabinet with 9 drawers	
Dim. mm 717x726x1450 h Central lock	



ORD. NO.	TYPE
F AG 2058 02 04	A
F AG 2058 52 04	B
Cabinet with 10 drawers	
Dim. mm 717x726x1450 h Central lock	



ORD. NO.	TYPE
F AG 2058 09 04	A
F AG 2058 59 04	B
Cabinet with 13 drawers	
Dim. mm 717x726x1450 h Central lock	

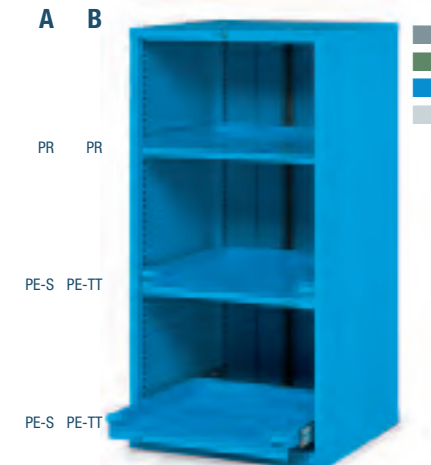

ORD. NO.	TYPE
F AG 2058 10 04	A
F AG 2058 60 04	B
Cabinet with 2 retractable shelves, 1 adjustable shelf	
Dimensions mm 717x726x1450 h Without lock, with anti-tilt rod	



ORD. NO.	TYPE
F AG 2058 11 04	A
F AG 2058 61 04	B
Cabinet with 3 drawers	
Dimensions mm 717x726x1450 h Central lock	

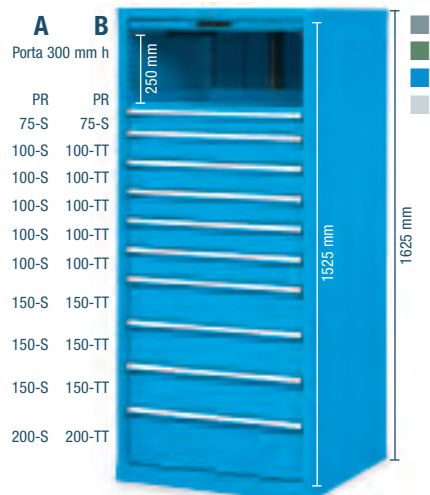

ORD. NO.	TYPE
F AG 2065 10 04	A
F AG 2065 60 04	B
Cabinet with 10 drawers	
Dim. mm 717x726x1625 h Central lock	



ORD. NO.	TYPE
F AG 2065 07 04	A
F AG 2065 57 04	B
Cabinet with 13 drawers	
Dim. mm 717x726x1625 h Central lock	



ORD. NO.	TYPE
F AG 2065 09 04	A
F AG 2065 59 04	B
Cabinet with 14 drawers	
Dim. mm 717x726x1625 h Central lock	

LENGTH = 717 mm DEPTH = 726 mm (36x36 Eh)

CABINETS SERIES STANDARD G

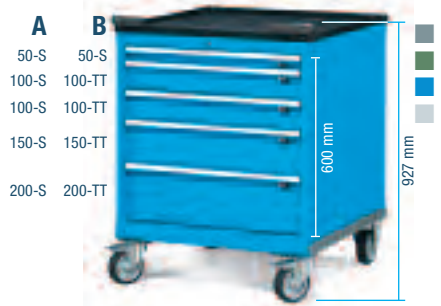

ORD. NO.	TYPE
F AG S228 01 04	A
F AG S228 51 04	B
Cabinet with 5 drawers, cabinet load capacity: 400 kg	
Ø 125 mm wheels in elastic rubber	
Dim. mm 717x802x927 h	Central lock



ORD. NO.	TYPE
F AG S228 02 04	A
F AG S228 52 04	B
Cabinet with 5 drawers, cabinet load capacity: 400 kg	
Ø 125 mm wheels in elastic rubber	
Dim. mm 717x802x927 h	Central lock



ORD. NO.	TYPE
F AG S228 03 04	A
F AG S228 53 04	B
Cabinet with 6 drawers, cabinet load capacity: 400 kg	
Ø 125 mm wheels in elastic rubber	
Dim. mm 717x802x927 h	Central lock



ORD. NO.	TYPE
F AG S232 01 04	A
F AG S232 51 04	B
Cabinet with 4 drawers, portata armadio: 400 kg	
Ø 125 mm wheels in elastic rubber	
Dim. mm 717x802x1027 h	Central lock



ORD. NO.	TYPE
F AG S232 02 04	A
F AG S232 52 04	B
Cabinet with 6 drawers, portata armadio: 400 kg	
Ø 125 mm wheels in elastic rubber	
Dim. mm 717x802x1027 h	Central lock



ORD. NO.	TYPE
F AG S232 03 04	A
F AG S232 53 04	B
Cabinet with 7 drawers, portata armadio: 400 kg	
Ø 125 mm wheels in elastic rubber	
Dim. mm 717x802x1027 h	Central lock



ORD. NO.	TYPE
F AG S234 01 04	A
F AG S234 51 04	B
Cabinet with 7 drawers	
Cabinet load capacity: 400 kg	
Ø 125 mm wheels in elastic rubber	
Dim. mm 717x802x1077 h	Central lock



ORD. NO.	TYPE
F AG S234 02 04	A
F AG S234 52 04	B
Cabinet with 7 drawers	
Cabinet load capacity: 400 kg	
Ø 125 mm wheels in elastic rubber	
Dim. mm 717x802x1077 h	Central lock

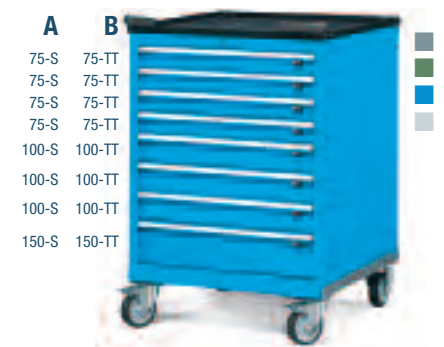

ORD. NO.	TYPE
F AG S234 03 04	A
F AG S234 53 04	B
Cabinet with 8 drawers	
Cabinet load capacity: 400 kg	
Ø 125 mm wheels in elastic rubber	
Dim. mm 717x802x1077 h	Central lock

KEY

RAL 7000 F.01 RAL 6011 F.02 RAL 5012 F.04 RAL 7035 F.08



- TT = telescopic full extension (100%)
- S = normal extension (87%)
- PR = height adjustable shelf
- All indicated loads are net and refer to evenly distributed weights.



The handles can be fitted towards the bottom thereby reducing the height by 38 mm.

Partitioning material: see page A96



CABINETS SERIES STANDARD G



- | | |
|----------|----------|
| A | B |
| 100-S | 100-TT |
| 100-S | 100-TT |
| 100-S | 100-TT |
| 150-S | 150-TT |
| 150-S | 150-TT |
| 300-TT | 300-TT |



- | | |
|----------|----------|
| A | B |
| 75-S | 75-TT |
| 75-S | 75-TT |
| 100-S | 100-TT |
| 150-S | 150-TT |
| 150-S | 150-TT |
| 150-S | 150-TT |
| 150-S | 150-TT |
| 200-S | 200-TT |



- | | |
|----------|----------|
| A | B |
| 50-S | 50-S |
| 75-S | 75-TT |
| 75-S | 75-TT |
| 100-S | 100-TT |
| 100-S | 100-TT |
| 150-S | 150-TT |
| 150-S | 150-TT |
| 150-S | 150-TT |
| 200-S | 200-TT |

ORD. NO.	TYPE
F AG S240 01 04	A
F AG S240 51 04	B
Cabinet with 6 drawers	
Cabinet load capacity: 400 kg	
Ø 125 mm wheels in elastic rubber	
Dimensions mm 717x802x1227 h	
Central lock	

ORD. NO.	TYPE
F AG S240 02 04	A
F AG S240 52 04	B
Cabinet with 7 drawers	
Cabinet load capacity: 400 kg	
Ø 125 mm wheels in elastic rubber	
Dimensions mm 717x802x1227 h	
Central lock	

ORD. NO.	TYPE
F AG S240 04 04	A
F AG S240 54 04	B
Cabinet with 8 drawers	
Cabinet load capacity: 400 kg	
Ø 125 mm wheels in elastic rubber	
Dimensions mm 717x802x1227 h	
Central lock	

■ The door can be closed by the edge of the lower drawer handle (ref. Y)



RAL 7000 F.01 RAL 6011 F.02 RAL 5012 F.04 RAL 7035 F.08

KEY ■

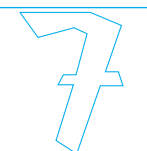

■ Partitioning material: see page A96

■ The handles can be fitted towards the bottom thereby reducing the height by 38 mm.



- TT = telescopic full extension (100%)
- S = normal extension (87%)
- All indicated loads are net and refer to evenly distributed weights.



LENGTH = 717 mm DEPTH = 726 mm (36x36 Eh)

CABINETS SERIES STANDARD G

EXAMPLE INCLUDING:**ORD. NO.****F AG L234 S1 50**

1 cabinet with wheels complete with 4 drawers

1 adjustable shelf

1 flap door

1 rubber covered MDF top

1 perforated back panel

Dimensions mm 717x802x1091/1791 h

Tools, hooks and toolboxes excluded



RAL 7035 + RAL 5012

KEY

RAL 7000 F.01

RAL 6011 F.02

RAL 5012 F.04

RAL 7035 F.08

■ Partitioning material: see page **A96**■ Hooks see page **C66**

■ All indicated loads are net and refer to evenly distributed weights.

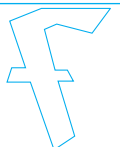

CABINETS SERIES STANDARD G

EMPTY CABINETS

ORD. NO.	USABLE HEIGHT mm	LOAD CAPACITY kg	DIMENSIONS mm
F AG 2016 00 04	300	3100	717x726x400 h
F AG 2028 00 04	600	3100	717x726x700 h
F AG 2032 00 04	700	3100	717x726x800 h
F AG 2034 00 04	750	3100	717x726x850 h
F AG 2040 00 04	900	3100	717x726x1000 h
F AG 2046 00 04	1050	3100	717x726x1150 h
F AG 2053 00 04	1225	3100	717x726x1325 h
F AG 2058 00 04	1350	3100	717x726x1450 h
F AG 2065 00 04	1525	3100	717x726x1625 h



■ The cabinets must be secured to the floor or to the wall. If the cabinets are stacked they must be secured to the wall and their load capacity must be divided by 2. Further information for fixing set see page A82.

SPARE LOCK

ORD. NO. R CSR 0003 00
for cabinet

■ 01 ■ 02 ■ 04 ■ 08

NORMAL EXTENSION DRAWERS (S)

ORD. NO.	FRONT HEIGHT mm	LOAD CAPACITY kg	USABLE DIMENSIONS mm
F FG 2005 00 04	50	60	600x600x36 h
F FG 2007 00 04	75	80	600x600x61 h
F FG 2010 00 04	100	100	600x600x86 h
F FG 2012 00 04	125	100	600x600x111 h
F FG 2015 00 04	150	100	600x600x136 h
F FG 2017 00 04	175	100	600x600x161 h
F FG 2020 00 04	200	100	600x600x186 h
F FG 2030 00 04	300	100	600x600x286 h

Normal extension (87%)



■ 01
■ 02
■ 04
■ 08

■ Partitioning material: see page A96-A97

FULL TELESCOPIC EXTENSION DRAWERS (TT)

ORD. NO.	FRONT HEIGHT mm	LOAD CAPACITY kg	USABLE DIMENSIONS mm
F FG 2107 00 04	75	200	600x600x54 h
F FG 2110 00 04	100	200	600x600x79 h
F FG 2112 00 04	125	200	600x600x104 h
F FG 2115 00 04	150	200	600x600x129 h
F FG 2117 00 04	175	200	600x600x154 h
F FG 2120 00 04	200	200	600x600x179 h
F FG 2125 00 04	250	200	600x600x229 h
F FG 2130 00 04	300	200	600x600x279 h
F FG 2140 00 04	400	200	600x600x379 h

Full telescopic extension (100%)

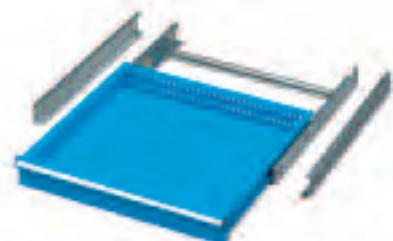

■ 01
■ 02
■ 04
■ 08

■ Partitioning material: see page A96-A97

NORMAL EXTENSION SHELVES (PE-S)

ORD. NO.	SIDE HEIGHT mm	LOAD CAPACITY kg	USABLE DIMENSIONS mm
F FG 8020 00 04	-	100	610x610

Normal extension (87%)

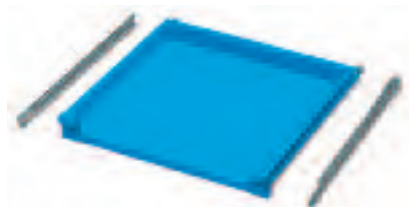

■ 01
■ 02
■ 04
■ 08

FULL TELESCOPIC EXTENSION SHELVES (PE-TT)

ORD. NO.	SIDE HEIGHT mm	LOAD CAPACITY kg	USABLE DIMENSIONS mm
F FG 8120 00 04	-	200	610x610

Full telescopic extension (100%)

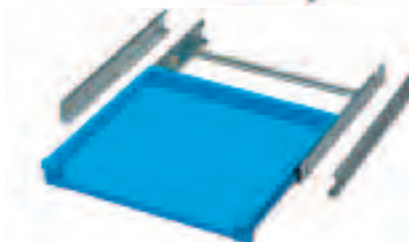

■ 01
■ 02
■ 04
■ 08

ADJUSTABLE SHELVES

ORD. NO.	SIDE HEIGHT mm	LOAD CAPACITY kg	USABLE DIMENSIONS mm
F SR 1260 01 04	25	150	618x618

Without extension system



■ 01
■ 02
■ 04
■ 08

LENGTH = 717 mm DEPTH = 726 mm (36x36 Eh)

CABINETS SERIES STANDARD G

CABINET TO CABINET FIXING

■ The article includes:
4 M8 nuts and bolts

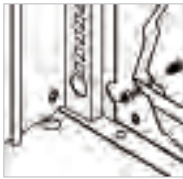

ORD. NO. F AG 9202 00 99

**TWO SIDED ADHESIVE TAPE**

ORD. NO.

R CMV 0025 00

width 15 mm, length 50 metres

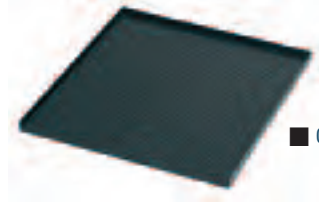

■ 07

TOP SHELF

ORD. NO.

DIMENSIONS mm

F AG 9003 01 07

717x726x20 h

oil-resistant rubber cover top with 3 edges



■ 07

PLINTHS

ORD. NO.

F RR 0070 00 07

Plinths height 50 mm



■ 07

PLINTHS FOR TRANSPALLET

ORD. NO.

F RR 0310 00 07 Plinths height 100 mm

F RR 0405 00 07 Facing piece



■ 07

PLINTHS FOR FORK LIFT TRUCK

ORD. NO.

F RR 0230 00 07 Pair of plinths height 60 mm

F RR 0400 00 07 Facing piece

EXAMPLE INCLUDING:

ORD. NO.

F AG 2040 S2 56

9 drawers

1 rubber cover top with 3 edges

1 plinth for transpallet

Dimensions mm 717x726x1120 h

Tools and partitioning material excluded



■ RAL 7035 +
■ RAL 7000

plinth for transpallet

■ **INFO**

RAL 7000 F.01

RAL 6011 F.02

RAL 5012 F.04

RAL 7035 F.08



www.famispa.com

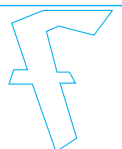

CABINETS SERIES STANDARD G

UPPER MDF TOP WITH RUBBER COVERING DIMENSIONS 718x726x31,5 mm H

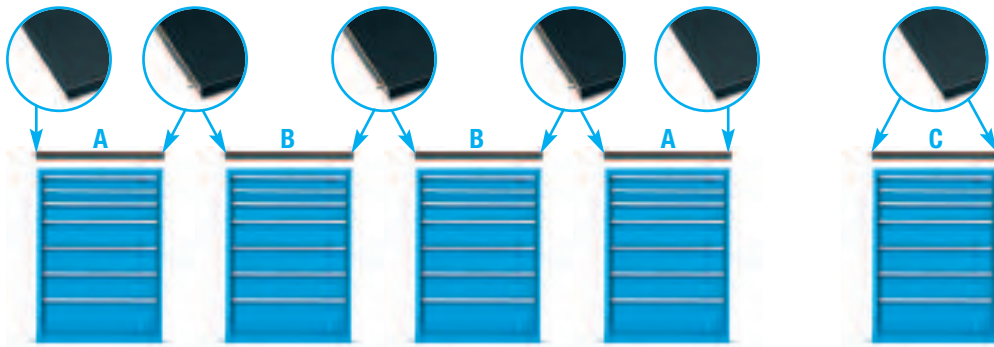

ORD. NO. F UZ 9999 00 00

Drilling of the cabinet upper shelf for the MDF top fixing.



Detail of the oil-resistant rubber

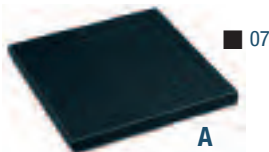

■ 07

A

ORD. NO.

F UZ 3220 11 07

MDF top with rubber covering

Side profile

For end cabinets

Oil-resistant rubber mat



■ 07

B

ORD. NO.

F UZ 3220 12 07

MDF top with rubber covering

No side profile

For additional central cabinets Oil-resist. rubber mat

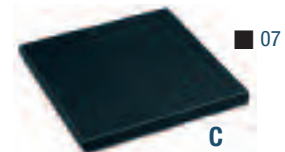

■ 07

C

ORD. NO.

F UZ 3220 13 07

MDF top with rubber covering

2 side profiles

For single cabinet

Oil-resistant rubber mat

CABINETS PREPARED FOR WHEELS

Cabinets prepared for wheels including: wheel plate, 4 edged top with oil-resistant rubber, 2 steel handles covered with shock-resistant rubber, cylinder lock with 2 keys, anti-tilt rod.

■ The single drawer opening system
ORD. NO. F DD 9400 00 07 must be applied to all drawers of mobile cabinets.



- 01
- 02
- 04
- 08

ORD. NO.

F AG 0228 00 04

Overall dim. mm:

717x802x767 h without wheels

*Wheel plate thickness

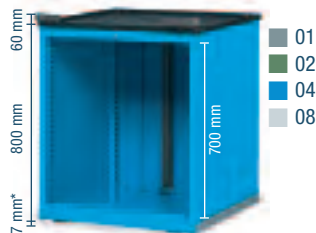

- 01
- 02
- 04
- 08

ORD. NO.

F AG 0232 00 04

Overall dim. mm:

717x802x867 h without wheels

*Wheel plate thickness



- 01
- 02
- 04
- 08

ORD. NO.

F AG 0234 00 04

Overall dim. mm:

717x802x917 h without wheels

*Wheel plate thickness

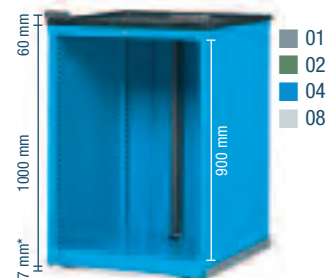

- 01
- 02
- 04
- 08

ORD. NO.

F AG 0240 00 04

Overall dim. mm:

717x802x1067 h without wheels

*Wheel plate thickness

ELASTIC RUBBER SWIVEL WHEEL WITH BRAKE

ORD. NO.	Ø mm	CABINET LOAD CAPACITY	C mm
C RG DCE15 125	125	400 kg	160

ELASTIC RUBBER FIXED WHEEL

ORD. NO.	Ø mm	CABINET LOAD CAPACITY	C mm
C RG BCE15 125	125	400 kg	160

NYLON SWIVEL WHEEL WITH BRAKE

ORD. NO.	Ø mm	CABINET LOAD CAPACITY	C mm
C RN DAD10 100	100	235 kg	130
C RN DAD11 125	125	400 kg	160

NYLON FIXED WHEEL

ORD. NO.	Ø mm	CABINET LOAD CAPACITY	C mm
C RN BAD10 100	100	235 kg	130
C RN BAD11 125	125	400 kg	160

RAL 7000 F.01 RAL 6011 F.02 RAL 5012 F.04 RAL 7035 F.08

KEY ■

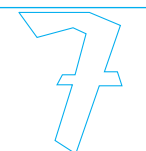

■ Other types of wheels see page A52

■ The handles can be fitted towards the bottom thereby reducing the height by 38 mm.



■ All indicated loads are net and refer to evenly distributed weights.



LENGTH = 717 mm DEPTH = 726 mm (36x36 Eh)

CABINETS SERIES STANDARD G

PERFORATED BACK PANEL

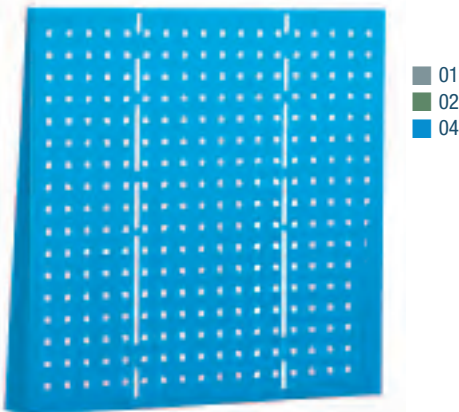

■ 01
■ 02
■ 04



■ This type of panel can be applied with an MDF top (see page A94) or with a multiplex worktop.

■ Hooks see page C66

ORD. NO.	DIMENSIONS mm
F DF 7942 00 04	716x93x420 h
F DF 7970 00 04	716x93x700 h

FLAP DOOR

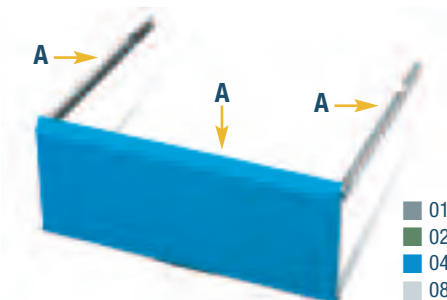

■ 01
■ 02
■ 04
■ 08

ORD. NO.	REFERENCE
F AG 9530 00 04	A+(Cx2)

Flap door with 2 guides and 2 brackets to block the door with the lower drawer locked.

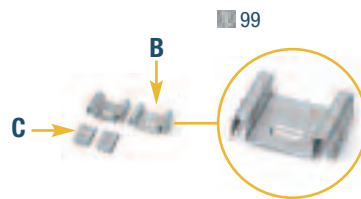

■ 99

ORD. NO.	REFERENCE
F DA 9698 00 99	B

The order number includes just 1 piece. 2 pieces are needed for each door.



■ The two stops (ref. B) must be used when the door is fitted along with the normal or full telescopic extension drawer (ref. Z). See photo ref. 5 page A79 to understand the usable internal volume.

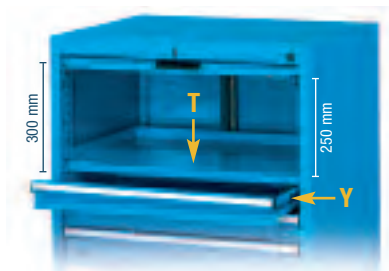

■ The two stops (ref. B) are not required when the door is fitted along with the adjustable shelf (ref. T) ORD. NO. F SR 1260 01 .. N. B. the drawer (ref. Y) must be normal extension.

■ The door can be closed by the edge of the lower drawer handle (ref. Y)



RACK



ORD. NO.
C MV 99 126

Standard (600x150 mm) CD or DVD rack.

Warning: The rack is supplied with length of 36 Eh (600 mm).



■ Standard CD or DVD cases (142x10x125 mm) can be stored into the 175 mm h drawer (with 4 ORD. NO. C MV 99 126 racks). The cases can be stored with their **spines facing upwards**. The racks are supplied with a length of 36 Eh (600 mm).
Quantity of CD/DVD cases which can be stored in one drawer:
drawer 175 normal extension: 120 pcs.
drawer 175 full telescopic extension: 160 pcs.



■ Standard CD or DVD cases (142x10x125 mm) can be stored into the 150 mm h drawer (with 4 ORD. NO. C MV 99 126 racks). The cases can be stored with their **spines facing sideways**. The racks are supplied with a length of 36 Eh (600 mm).
Quantity of CD/DVD cases which can be stored in one drawer:
drawer 150 normal extension: 120 pcs.
drawer 150 full telescopic extension: 160 pcs.

CABINETS SERIES STANDARD G

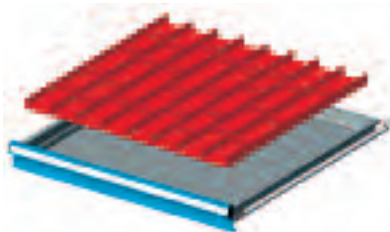

ORD. NO.	FOR FRONT HEIGHTS
F FH 2005 15 00	50-300
Set including:	
16 Troughs	2 grooves
35 Plain partitions	73 mm

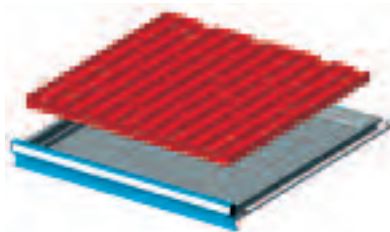

ORD. NO.	FOR FRONT HEIGHTS
F FH 2005 16 00	50-300
Set including:	
16 Troughs	3 grooves
50 Plain partitions	47 mm

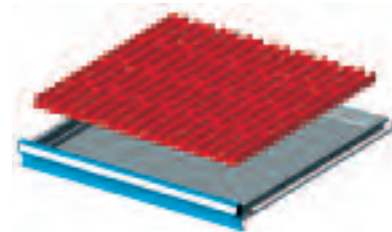

ORD. NO.	FOR FRONT HEIGHTS
F FH 2005 17 00	50-300
Set including:	
16 Troughs	4 grooves
65 Plain partitions	36 mm

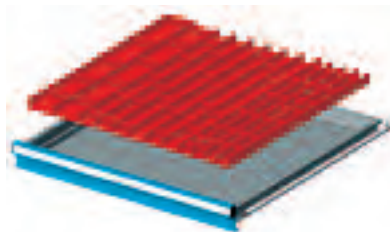

ORD. NO.	FOR FRONT HEIGHTS
F FH 2005 20 00	50-300
Set including:	
4 Troughs	4 grooves
30 Plain partitions	36 mm
8 Troughs	3 grooves
20 Plain partitions	47 mm
4 Troughs	2 grooves
10 Plain partitions	73 mm

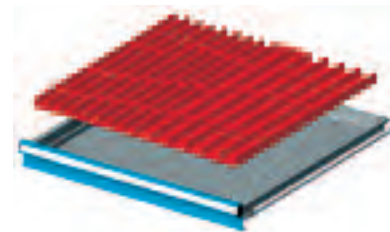

ORD. NO.	FOR FRONT HEIGHTS
F FH 2005 21 00	50-300
Set including:	
8 Troughs	4 grooves
24 Plain partitions	36 mm
8 Troughs	3 grooves
16 Plain partitions	47 mm

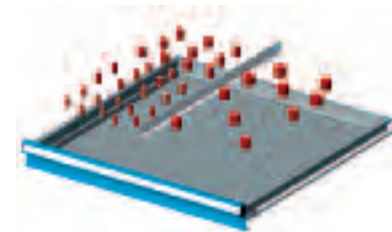

ORD. NO.	FOR FRONT HEIGHTS
F FH 2005 19 00	50-300
Set including:	
1 Plain partition	610 mm
10 Cutter holders	Ø 12,2 mm
10 Cutter holders	Ø 15,5 mm
10 Cutter holders	Ø 21,5 mm
5 Cutter holders	Ø 26,5 mm
5 Cutter holders	Ø 31,2 mm

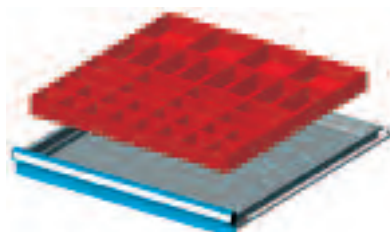

ORD. NO.	FOR FRONT HEIGHTS
F FH 2005 12 00	50
F FH 2007 12 00	75
Set including:	
16 Plastic boxes	75x75 mm
16 Plastic boxes	150x75 mm
4 Plastic boxes	150x150 mm

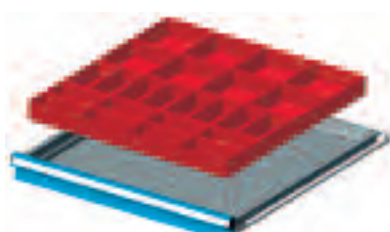

ORD. NO.	FOR FRONT HEIGHTS
F FH 2005 13 00	50
F FH 2007 13 00	75
F FH 2010 13 00	100-125
Set including:	
16 Plastic boxes	150x75 mm
8 Plastic boxes	150x150 mm

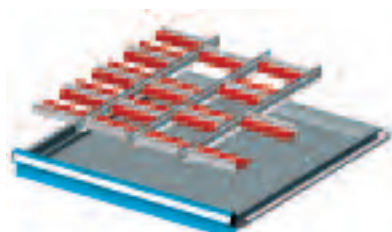

ORD. NO.	FOR FRONT HEIGHTS
F FH 2005 25 00	50-300
Set including:	
3 Slotted partitions	610 mm
15 Plain partitions	149 mm
4 Angle trays	6 grooves
3 Angle trays	8 grooves
4 Angle trays	11 grooves



■ Partitioning material: see page A180

INFO ■

www.famispa.com



LENGTH = 717 mm DEPTH = 726 mm (36x36 Eh)

CABINETS SERIES STANDARD G

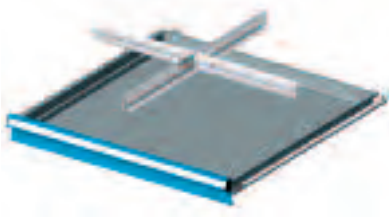

ORD. NO.	FOR FRONT HEIGHTS
F FH 2005 05 00	50
F FH 2007 05 00	75
F FH 2010 05 00	100-125
F FH 2015 05 00	150-175
F FH 2020 05 00	200-250
F FH 2030 05 00	300
Set including:	
1 Slotted partition	610 mm
2 Plain partitions	302 mm

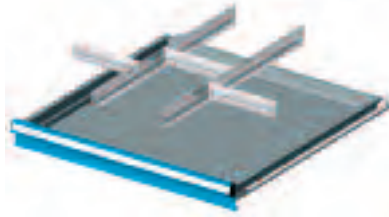

ORD. NO.	FOR FRONT HEIGHTS
F FH 2005 06 00	50
F FH 2007 06 00	75
F FH 2010 06 00	100-125
F FH 2015 06 00	150-175
F FH 2020 06 00	200-250
F FH 2030 06 00	300
Set including:	
2 Slotted partitions	610 mm
3 Plain partitions	200 mm

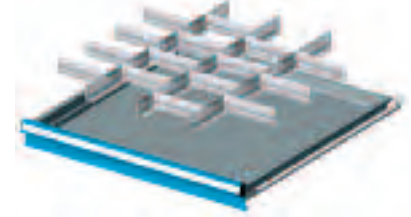

ORD. NO.	FOR FRONT HEIGHTS
F FH 2005 07 00	50
F FH 2007 07 00	75
F FH 2010 07 00	100-125
F FH 2015 07 00	150-175
F FH 2020 07 00	200-250
Set including:	
3 Slotted partitions	610 mm
15 Plain partitions	149 mm

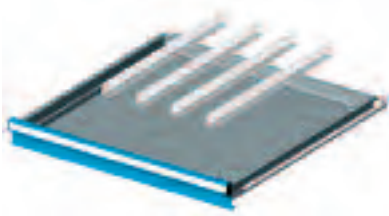

ORD. NO.	FOR FRONT HEIGHTS
F FH 2005 22 00	50
F FH 2007 22 00	75
F FH 2010 22 00	100-125
F FH 2015 22 00	150-175
F FH 2020 22 00	200-250
Set including:	
4 Plain partitions	610 mm

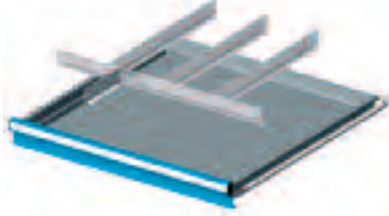

ORD. NO.	FOR FRONT HEIGHTS
F FH 2005 23 00	50
F FH 2007 23 00	75
F FH 2010 23 00	100-125
F FH 2015 23 00	150-175
F FH 2020 23 00	200-250
Set including:	
1 Slotted partition	610 mm
3 Plain partitions	455 mm
1 Plain partition	149 mm



ORD. NO.	FOR FRONT HEIGHTS
F FH 2005 24 00	50
F FH 2007 24 00	75
F FH 2010 24 00	100-125
F FH 2015 24 00	150-175
Set including:	
1 Slotted partition	610 mm
5 Plain partitions	405 mm
4 Plain partitions	98 mm

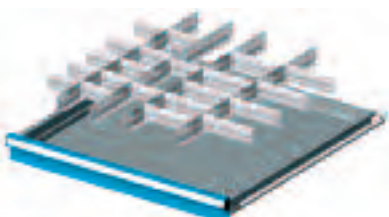

ORD. NO.	FOR FRONT HEIGHTS
F FH 2005 08 00	50
F FH 2007 08 00	75
F FH 2010 08 00	100-125
Set including:	
4 Slotted partitions	610 mm
12 Plain partitions	98 mm
9 Plain partitions	149 mm



ORD. NO.	FOR FRONT HEIGHTS
F FH 2005 09 00	50
F FH 2007 09 00	75
F FH 2010 09 00	100-125
F FH 2015 09 00	150-175
Set including:	
5 Slotted partitions	610 mm
20 Plain partitions	98 mm

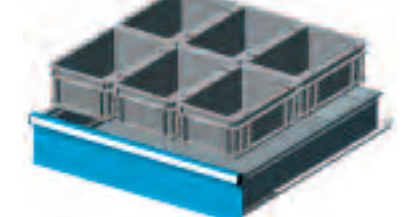

ORD. NO.	FOR FRONT HEIGHTS
F FH 2015 18 00	150-175
F FH 2020 18 00	200-250
Set including:	
6 Cassette athena	300x200 mm

■ INFO

www.famispa.com

■ Partitioning material: see page A180

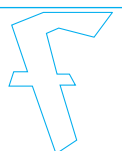

ORD. NO. F BL 1020 00 00
Steel vice 130 mm



ORD. NO. F AG 3040 S1 51
RAL 5012+7000



ORD. NO. F AG L334 S1 51
RAL 5012+7000

45 EH (753 mm)



36 EH (600 mm)

FLOOR FIXING SET



2x

- 2 "HILTI" plugs for concrete floors \geq to classes B25/RBK250/MPA 25 N/mm²
- Recommended traction of the plug: 2.9 KN
- Plug diameter: \varnothing 6 mm

ORD. NO. F AG 9204 00 99

CABINET FLOOR FIXING SET

- Pair of spare galvanised brackets
- \varnothing 6 mm hole



ORD. NO. F AG 9200 00 99

CABINET ORD. NO.

F AG 3040 S1 51

- Complete with 8 drawers
- 1 multiplex worktop 40 mm thickness
- 1 plinth for transpallet
- Dimensions mm 870x750x1140 h

Tools and partitioning material excluded

CABINET WITH WHEELS ORD. NO.

F AG L334 S1 51

- Complete with 7 drawers
- 1 rubber cover MDF top
- Dimensions mm 945x727x1091 h

RAL 7000 F.01

RAL 6011 F.02

RAL 5012 F.04

RAL 7035 F.08

SUPPLEMENTARY PARTS ■



- Partitioning material: see page A104



- **Spare key.** Always indicate the number on the cylinder lock of the key to be replaced.

ORD. NO. R CSC 0002 00

- **Master key.** This type of key opens all the 45 and 46 series locks.

ORD. NO. R CSC 0001 00



LENGTH = 870 mm DEPTH = 726 mm (45x36 Eh)

CABINETS SERIES STANDARD GG

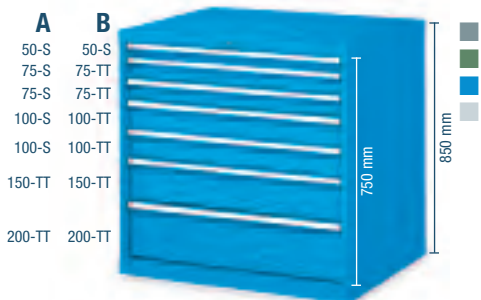

- A 50-S 50-S
- B 75-S 75-TT
- 75-S 75-TT
- 100-S 100-TT
- 100-S 100-TT
- 150-TT 150-TT
- 200-TT 200-TT

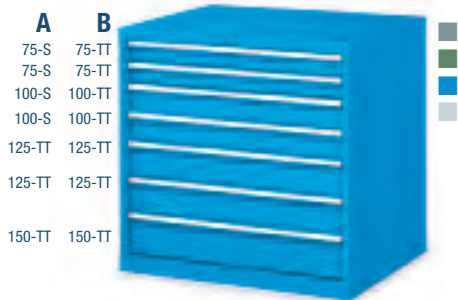

- A 75-S 75-TT
- B 75-S 75-TT
- 100-S 100-TT
- 100-S 100-TT
- 125-TT 125-TT
- 125-TT 125-TT
- 150-TT 150-TT



- A 75-S 75-TT
- B 75-S 75-TT
- 75-S 75-TT
- 100-S 100-TT
- 100-S 100-TT
- 100-S 100-TT
- 150-TT 150-TT

ORD. NO.	TYPE
F AG 3034 01 04	A
F AG 3034 51 04	B
Cabinet with 7 drawers	
Dim. mm 870x726x850 h	Central lock

ORD. NO.	TYPE
F AG 3034 02 04	A
F AG 3034 52 04	B
Cabinet with 7 drawers	
Dim. mm 870x726x850 h	Central lock

ORD. NO.	TYPE
F AG 3034 03 04	A
F AG 3034 53 04	B
Cabinet with 8 drawers	
Dim. mm 870x726x850 h	Central lock

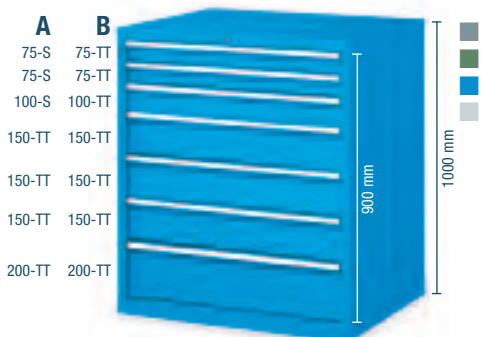

- A 75-S 75-TT
- B 75-S 75-TT
- 100-S 100-TT
- 150-TT 150-TT
- 150-TT 150-TT
- 150-TT 150-TT
- 200-TT 200-TT

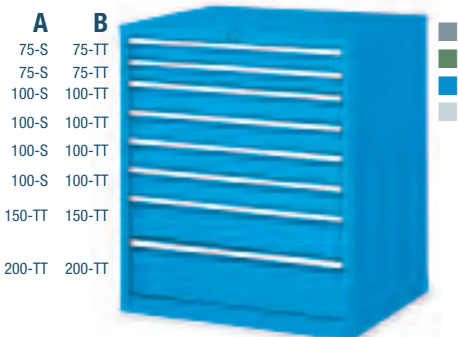

- A 75-S 75-TT
- B 75-S 75-TT
- 100-S 100-TT
- 100-S 100-TT
- 100-S 100-TT
- 150-TT 150-TT
- 200-TT 200-TT



- A 50-S 50-S
- B 50-S 50-S
- 50-S 50-S
- 75-S 75-TT
- 75-S 75-TT
- 100-S 100-TT
- 100-S 100-TT
- 150-TT 150-TT
- 200-TT 250-TT

ORD. NO.	TYPE
F AG 3040 02 04	A
F AG 3040 52 04	B
Cabinet with 7 drawers	
Dim. mm 870x726x1000 h	Central lock

ORD. NO.	TYPE
F AG 3040 04 04	A
F AG 3040 54 04	B
Cabinet with 8 drawers	
Dim. mm 870x726x1000 h	Central lock

ORD. NO.	TYPE
F AG 3040 05 04	A
F AG 3040 55 04	B
Cabinet with 9 drawers	
Dim. mm 870x726x1000 h	Central lock

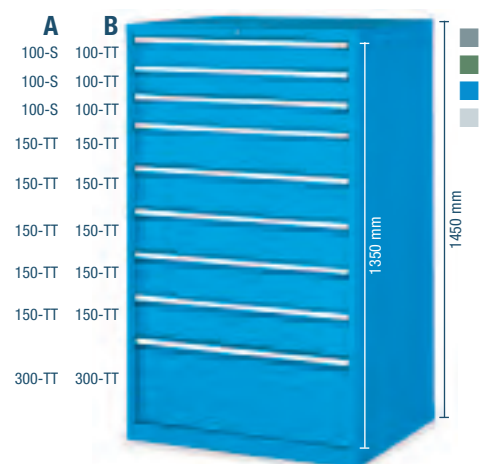

- A 100-S 100-TT
- B 100-S 100-TT
- 100-S 100-TT
- 150-TT 150-TT
- 150-TT 150-TT
- 150-TT 150-TT
- 150-TT 150-TT
- 150-TT 150-TT
- 150-TT 150-TT
- 300-TT 300-TT

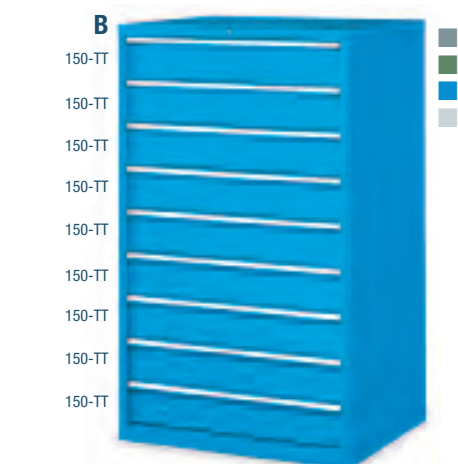

- A 150-TT
- B 150-TT
- 150-TT
- 150-TT
- 150-TT
- 150-TT
- 150-TT
- 150-TT
- 150-TT
- 150-TT

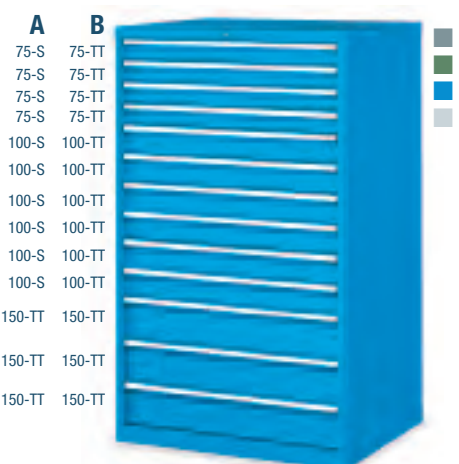

- A 75-S 75-TT
- B 75-S 75-TT
- 75-S 75-TT
- 75-S 75-TT
- 100-S 100-TT
- 100-S 100-TT
- 100-S 100-TT
- 100-S 100-TT
- 100-S 100-TT
- 150-TT 150-TT
- 150-TT 150-TT
- 150-TT 150-TT

ORD. NO.	TYPE
F AG 3058 01 04	A
F AG 3058 51 04	B
Cabinet with 9 drawers	
Dim. mm 870x726x1450 h	Central lock

ORD. NO.	TYPE
-	
F AG 3058 52 04	B
Cabinet with 9 drawers	
Dim. mm 870x726x1450 h	Central lock

ORD. NO.	TYPE
F AG 3058 03 04	A
F AG 3058 53 04	B
Cabinet with 13 drawers	
Dim. mm 870x726x1450 h	Central lock

KEY



- The cabinets must be secured to the floor or to the wall.
- TT = telescopic full extension (100%)
- S = normal extension (87%)

RAL 7000 F.01 RAL 6011 F.02 RAL 5012 F.04 RAL 7035 F.08

■ Partitioning material: see page A104



CABINETS SERIES STANDARD GG



- A 50-S 50-S
- B 75-S 75-TT
- 75-S 75-TT
- 75-S 75-TT
- 100-S 100-TT
- 100-S 100-TT
- 150-TT 150-TT
- 200-TT 200-TT



- A 75-S 75-TT
- B 75-S 75-TT
- 75-S 75-TT
- 100-S 100-TT
- 100-S 100-TT
- 125-TT 125-TT
- 125-TT 125-TT
- 150-TT 150-TT

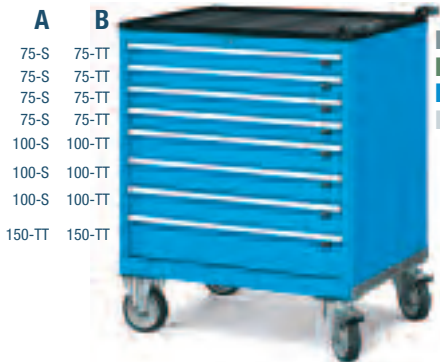

- A 75-S 75-TT
- B 75-S 75-TT
- 75-S 75-TT
- 75-S 75-TT
- 75-S 75-TT
- 100-S 100-TT
- 100-S 100-TT
- 100-S 100-TT
- 150-TT 150-TT

ORD. NO.	TYPE
F AG L334 01 04	A
F AG L334 51 04	B
Cabinet with 7 drawers	
Cabinet load capacity: 600 kg	
Ø 160 mm elastic rubber wheels	
Dimensions mm 945x727x1121 h	
Central lock	

ORD. NO.	TYPE
F AG L334 02 04	A
F AG L334 52 04	B
Cabinet with 7 drawers	
Cabinet load capacity: 600 kg	
Ø 160 mm elastic rubber wheels	
Dimensions mm 945x727x1121 h	
Central lock	

ORD. NO.	TYPE
F AG L334 03 04	A
F AG L334 53 04	B
Cabinet with 8 drawers	
Cabinet load capacity: 600 kg	
Ø 160 mm elastic rubber wheels	
Dimensions mm 945x727x1121 h	
Central lock	



- A 100-S 100-TT
- B 100-S 100-TT
- 100-S 100-TT
- 100-S 100-TT
- 150-TT 150-TT
- 150-TT 150-TT
- 300-TT 300-TT



- A 75-S 75-TT
- B 75-S 75-TT
- 75-S 75-TT
- 100-S 100-TT
- 150-TT 150-TT
- 150-TT 150-TT
- 150-TT 150-TT
- 150-TT 150-TT
- 200-TT 200-TT



- A 50-S 50-S
- B 75-S 75-TT
- 75-S 75-TT
- 75-S 75-TT
- 100-S 100-TT
- 100-S 100-TT
- 150-TT 150-TT
- 150-TT 150-TT
- 150-TT 150-TT
- 200-TT 200-TT

ORD. NO.	TYPE
F AG L340 01 04	A
F AG L340 51 04	B
Cabinet with 6 drawers	
Cabinet load capacity: 600 kg	
Ø 160 mm elastic rubber wheels	
Dimensions mm 945x727x1271 h	
Central lock	

ORD. NO.	TYPE
F AG L340 02 04	A
F AG L340 52 04	B
Cabinet with 7 drawers	
Cabinet load capacity: 600 kg	
Ø 160 mm elastic rubber wheels	
Dimensions mm 945x727x1271 h	
Central lock	

ORD. NO.	TYPE
F AG L340 03 04	A
F AG L340 53 04	B
Cabinet with 8 drawers	
Cabinet load capacity: 600 kg	
Ø 160 mm elastic rubber wheels	
Dimensions mm 945x727x1271 h	
Central lock	

- RAL 7000 F.01
- RAL 6011 F.02
- RAL 5012 F.04
- RAL 7035 F.08

KEY ■

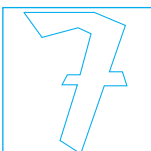

■ Partitioning material: see page A104

■ The handles can be fitted towards the bottom thereby reducing the height by 38 mm.



- TT = telescopic full extension (100%)
- S = normal extension (87%)
- All indicated loads are net and refer to evenly distributed weights



LENGTH = 870 mm DEPTH = 726 mm (45x36 Eh)

CABINETS SERIES STANDARD GG

CABINET WITH WHEELS**ORD. NO.****F AG L334 S1 51**complete with 7 drawers,
1 rubber cover MDF top**Dimensions mm 945x727x1091 h**

Tools and partitioning material excluded



■ RAL 5012 + ■ RAL 7000



■ RAL 5012 + ■ RAL 7000

CABINET**ORD. NO.****F AG 3034 S1 51**

7 drawers

1 multiplex worktop 40 mm thickness

1 plinth for transpallet

Dimensions mm 870x750x990 h

Tools and partitioning material excluded

■ **INFO**

RAL 7000 F.01

RAL 6011 F.02

RAL 5012 F.04

RAL 7035 F.08

■ Partitioning
material: see
page A180
www.famispa.com

CABINETS SERIES STANDARD GG

EMPTY CABINETS

ORD. NO.	USABLE HEIGHT mm	LOAD CAPACITY kg	DIMENSIONS mm
F AG 3034 00 04	750	3100	870x726x850 h
F AG 3040 00 04	900	3100	870x726x1000 h
F AG 3058 00 04	1350	3100	870x726x1450 h



SPARE LOCK

ORD. NO. R CSR 0003 00
for cabinet

■ 01 ■ 02 ■ 04 ■ 08

■ The cabinets must be secured to the floor or to the wall. If the cabinets are stacked they must be secured to the wall and their load capacity must be divided by 2. Further information for fixing set see page A98.

NORMAL EXTENSION DRAWERS (S)

ORD. NO.	FRONT HEIGHT mm	LOAD CAPACITY kg	USABLE DIMENSIONS mm
F FG 3005 00 04	50	60	753x600x36 h
F FG 3007 00 04	75	80	753x600x61 h
F FG 3010 00 04	100	100	753x600x86 h

Normal extension (87%)



■ 01
■ 02
■ 04
■ 08

■ Partitioning material: see page A104-A105

FULL TELESCOPIC EXTENSION DRAWERS (TT)

ORD. NO.	FRONT HEIGHT mm	LOAD CAPACITY kg	USABLE DIMENSIONS mm
F FG 3107 00 04	75	200	753x600x54 h
F FG 3110 00 04	100	200	753x600x79 h
F FG 3112 00 04	125	200	753x600x104 h
F FG 3115 00 04	150	200	753x600x129 h
F FG 3120 00 04	200	200	753x600x179 h
F FG 3125 00 04	250	200	753x600x229 h
F FG 3130 00 04	300	200	753x600x279 h

Full telescopic extension (100%)

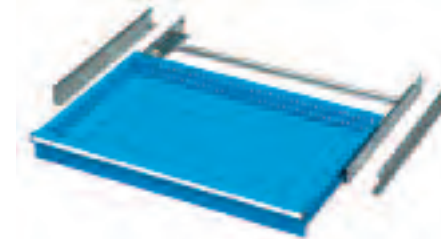

■ 01
■ 02
■ 04
■ 08

■ Partitioning material: see page A104-A105

NORMAL EXTENSION SHELVES (PE-S)

ORD. NO.	SIDE HEIGHT mm	LOAD CAPACITY kg	USABLE DIMENSIONS mm
F FG 8030 00 04	-	100	763x610

Normal extension (87%)



■ 01
■ 02
■ 04
■ 08

FULL TELESCOPIC EXTENSION SHELVES (PE-TT)

ORD. NO.	SIDE HEIGHT mm	LOAD CAPACITY kg	USABLE DIMENSIONS mm
F FG 8130 00 04	-	200	763x610

Full telescopic extension (100%)

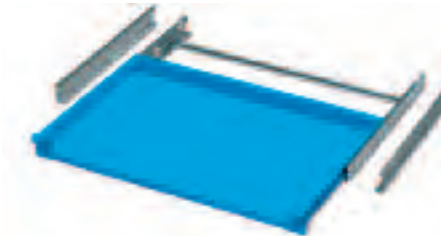

■ 01
■ 02
■ 04
■ 08

ADJUSTABLE SHELVES

ORD. NO.	SIDE HEIGHT mm	LOAD CAPACITY kg	USABLE DIMENSIONS mm
F SR 1265 01 04	25	100	814x618

Without extension system



■ 01
■ 02
■ 04
■ 08

RAL 7000 F.01 RAL 6011 F.02 RAL 5012 F.04 RAL 7035 F.08

KEY ■

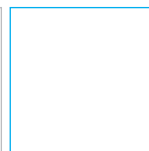
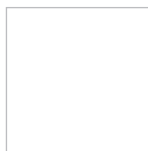
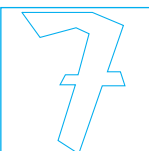

■ All indicated loads are net and refer to evenly distributed weights



LENGTH = 870 mm DEPTH = 726 mm (45x36 Eh)

CABINETS SERIES STANDARD GG

CABINET TO CABINET FIXING

■ The article includes:
4 M8 nuts and bolts

ORD. NO. F AG 9202 00 99

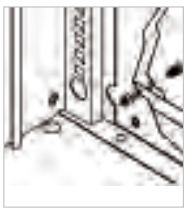

TWO SIDED ADHESIVE TAPE

ORD. NO.

R CMV 0025 00

width 15 mm, length 50 metri



TOP SHELF

ORD. NO.

F AG 9006 01 07

DIMENSIONS mm

870x726x20 h

oil-resistant rubber cover top with 3 edges

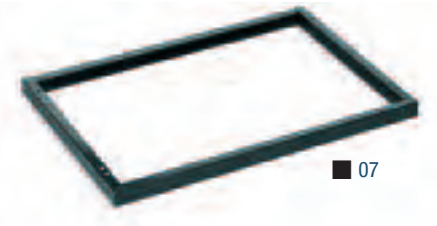

PLINTHS

ORD. NO.

F RR 0087 00 07

Plinths height 50 mm



PLINTHS FOR TRANSPALLET

ORD. NO.

F RR 0235 00 07 Plinths height 100 mm

F RR 0408 00 07 Facing piece

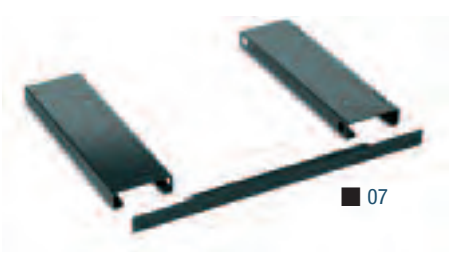

PLINTHS FOR FORK LIFT TRUCK

ORD. NO.

F RR 0230 00 07 Pair of plinths height 60 mm

F RR 0407 00 07 Facing piece

UPPER MDF TOP WITH RUBBER COVERING DIMENSIONS 871x726x31,5 mm H

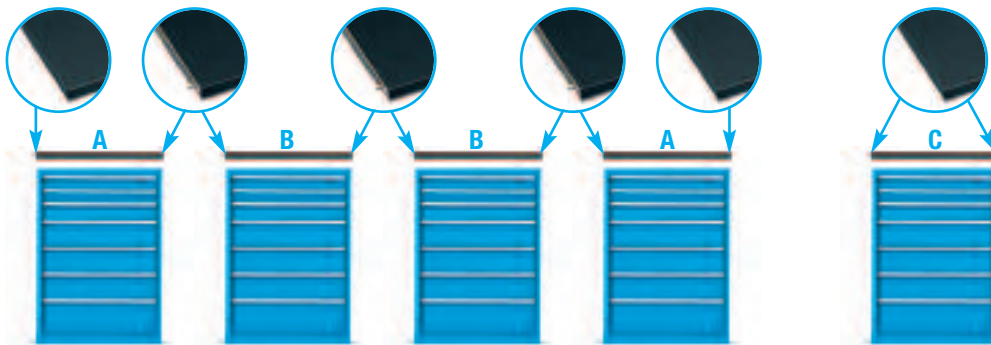

ORD. NO. F UZ 9999 00 00

Drilling of the cabinet upper shelf for the MDF top fixing.



Detail of oil-resistant rubber

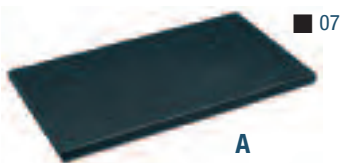

ORD. NO.

F UZ 3230 11 07

MDF top with rubber covering

Side profile

For end cabinets

Oil-resistant rubber mat



ORD. NO.

F UZ 3230 12 07

MDF top with rubber covering

No side profile

For additional central cabinets Oil-resist. rubber mat

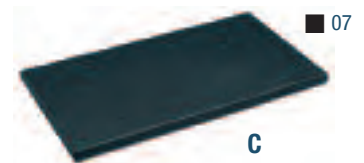

ORD. NO.

F UZ 3230 13 07

MDF top with rubber covering

2 side profiles

For single cabinet

Oil-resistant rubber mat

■ **INFO**

RAL 7000 F.01

RAL 6011 F.02

RAL 5012 F.04

RAL 7035 F.08



www.famispa.com

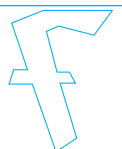

CABINETS SERIES STANDARD GG

CABINETS PREPARED FOR WHEELS

Cabinets prepared for wheels including: wheel plate, 4 edged top with oil-resistant rubber, 2 steel handles covered with shock-resistant rubber, cylinder lock with 2 keys, anti-tilt rod.

- 01
- 02
- 04
- 08



ORD. NO.

F AG 0334 00 04

Overall dim. mm:
945x727x917 h without wheels
 *Wheel plate thickness

- 01
- 02
- 04
- 08

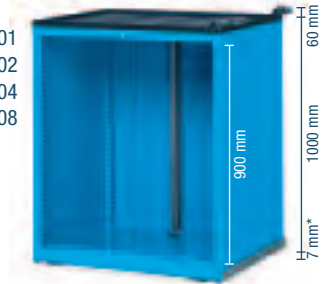

ORD. NO.

F AG 0340 00 04

Overall dim. mm:
945x727x1067 h without wheels
 *Wheel plate thickness



■ The single drawer opening system **ORD. NO. F DD 9400 00 07** must be applied to all drawers of mobile cabinets.

■ Other types of wheels see page A52



ELASTIC RUBBER SWIVEL WHEEL WITH BRAKE

ORD. NO.	Ø mm	CABINET LOAD CAPACITY	C mm
C RG DCE15 160	160	600 kg	204



ELASTIC RUBBER FIXED WHEEL

ORD. NO.	Ø mm	CABINET LOAD CAPACITY	C mm
C RG BCE15 160	160	600 kg	204



NYLON SWIVEL WHEEL WITH BRAKE

ORD. NO.	Ø mm	CABINET LOAD CAPACITY	C mm
C RN DAD04 160	160	600 kg	204



NYLON FIXED WHEEL

ORD. NO.	Ø mm	CABINET LOAD CAPACITY	C mm
C RN BAD04 160	160	600 kg	204

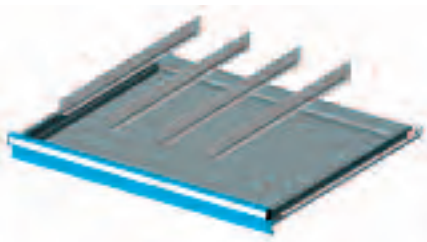

ORD. NO.	FOR FRONT HEIGHTS
F FH 2005 22 00	50
F FH 2007 22 00	75
F FH 2010 22 00	100-125
F FH 2015 22 00	150-175
F FH 2020 22 00	200-250
Set including:	
4 Plain partitions	610 mm

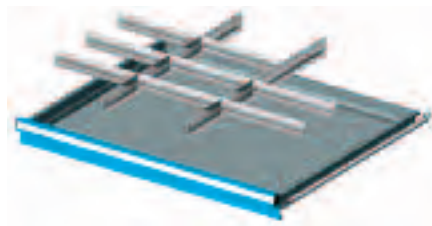

ORD. NO.	FOR FRONT HEIGHTS
F FH 3010 02 00	100-125
F FH 3015 02 00	150-175
F FH 3020 02 00	200-250
F FH 3030 02 00	300
Set including:	
2 Slotted partitions	610 mm
8 Plain partitions	251 mm



ORD. NO.	FOR FRONT HEIGHTS
F FH 3007 03 00	75
F FH 3010 03 00	100-125
F FH 3015 03 00	150-175
F FH 3020 03 00	200-250
F FH 3030 03 00	300
Set including:	
4 Slotted partitions	610 mm
21 Plain partitions	149 mm

- RAL 7000 F.01
- RAL 6011 F.02
- RAL 5012 F.04
- RAL 7035 F.08

KEY ■

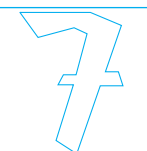

■ Partitioning material: see page A180

■ The handles can be fitted towards the bottom thereby reducing the height by 38 mm.



■ All indicated loads are net and refer to evenly distributed weights



LENGTH = 870 mm DEPTH = 726 mm (45x36 Eh)

CABINETS SERIES STANDARD GG

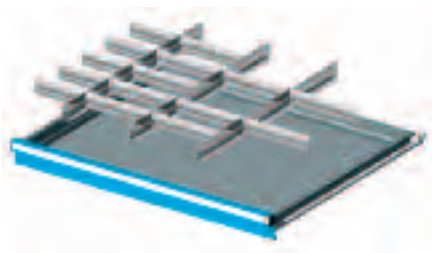

ORD. NO.	FOR FRONT HEIGHTS
F FH 3007 04 00	75
F FH 3010 04 00	100-125
F FH 3015 04 00	150-175
F FH 3020 04 00	200-250
F FH 3030 04 00	300
Set including:	
3 Slotted partitions	610 mm
5 Plain partitions	149 mm
10 Plain partitions	200 mm



ORD. NO.	FOR FRONT HEIGHTS
F FH 3005 05 00	50
F FH 3007 05 00	75
F FH 3010 05 00	100-125
Set including:	
5 Slotted partitions	610 mm
15 Plain partitions	98 mm
5 Plain partitions	149 mm



ORD. NO.	FOR FRONT HEIGHTS
F FH 3005 06 00	50
F FH 3007 06 00	75
F FH 3010 06 00	100-125
Set including:	
6 Slotted partitions	610 mm
24 Plain partitions	98 mm
1 Plain partition	149 mm

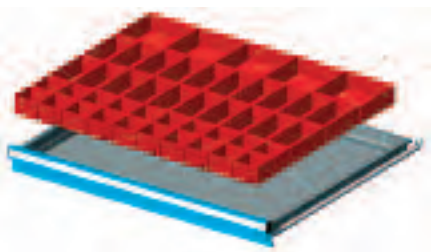

ORD. NO.	FOR FRONT HEIGHTS
F FH 3005 07 00	50
F FH 3007 07 00	75
Set including:	
20 Plastic boxes	75x75 mm
20 Plastic boxes	150x75 mm
5 Plastic boxes	150x150 mm

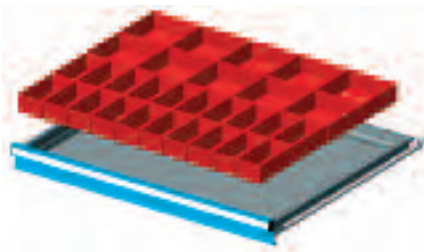

ORD. NO.	FOR FRONT HEIGHTS
F FH 3005 08 00	50
F FH 3007 08 00	75
F FH 3010 08 00	100-125
Set including:	
20 Plastic boxes	150x75 mm
10 Plastic boxes	150x150 mm

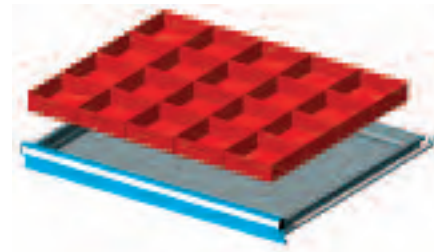

ORD. NO.	FOR FRONT HEIGHTS
F FH 3005 09 00	50
F FH 3007 09 00	75
F FH 3010 09 00	100-125
Set including:	
20 Plastic boxes	150x150 mm

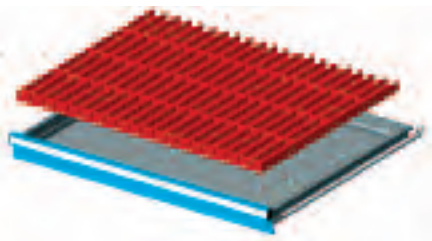

ORD. NO.	FOR FRONT HEIGHTS
F FH 3005 10 00	50-300
Set including:	
20 Troughs	4 grooves
135 Plain partitions	36 mm

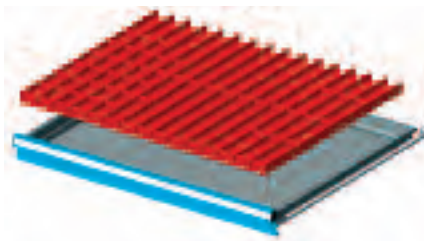

ORD. NO.	FOR FRONT HEIGHTS
F FH 3005 12 00	50-300
Set including:	
20 Troughs	3 grooves
100 Plain partitions	47 mm

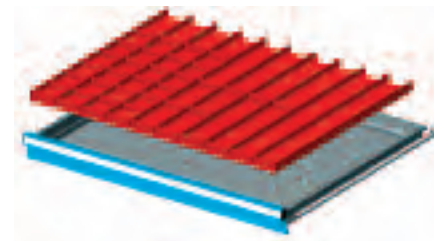

ORD. NO.	FOR FRONT HEIGHTS
F FH 3005 14 00	50-300
Set including:	
20 Troughs	2 grooves
70 Plain partitions	73 mm

■ INFO

www.famispa.com

■ Partitioning material: see page A180



CABINETS SERIES STANDARD GF



ORD. NO. F AG L434 04 2Y
RAL 3020

ORD. NO. F AG 4040 S1 08
RAL 7035

54 EH (906 mm)

27 EH (447 mm)

FLOOR FIXING SET



2x

- 2 "HILTI" plugs for concrete floors \geq to classes B25/RBK250/MPa 25 N/mm²
- Recommended traction of the plug: 2.9 KN
- Plug diameter: \varnothing 6 mm

ORD. NO. F AG 9204 00 99

CABINET FLOOR FIXING SET

- Pair of spare galvanised brackets
- \varnothing 6 mm hole



ORD. NO. F AG 9200 00 99

CABINET

ORD. NO.

F AG 4040 S1 08

Complete with 6 drawers,
1 rubber cover MDF top

Dimensions mm 1023x573x1030 h

Tools and partitioning material
excluded

CABINET WITH WHEELS

ORD. NO.

F AG L434 04 2Y

Complete with 5 drawers

Dimensions mm 1098x574x1121 h

RAL 7000 F.01

RAL 6011 F.02

RAL 5012 F.04

RAL 7035 F.08

SUPPLEMENTARY PARTS ■

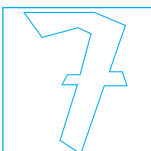

- Partitioning material: see page A113



- **Spare key.** Always indicate the number on the cylinder lock of the key to be replaced.

ORD. NO. R CSC 0002 00

- **Master key.** This type of key opens all the 45 and 46 series locks.

ORD. NO. R CSC 0001 00



LENGTH = 1023 mm DEPTH = 573 mm (54x27 Eh)

CABINETS SERIES STANDARD GF



• ORD. NO.	TYPE
F AG 4034 01 04	A
F AG 4034 51 04	B
Cabinet with 5 drawers	
Dim. mm 1023x573x850 h Central lock	

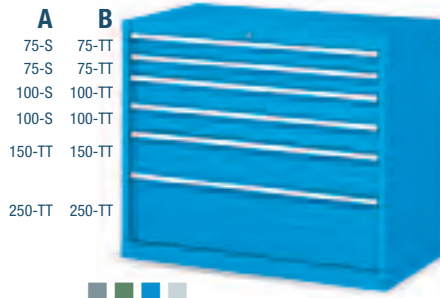

• ORD. NO.	TYPE
F AG 4034 02 04	A
F AG 4034 52 04	B
Cabinet with 6 drawers	
Dim. mm 1023x573x850 h Central lock	

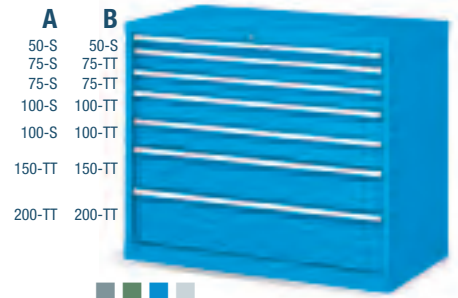

• ORD. NO.	TYPE
F AG 4034 03 04	A
F AG 4034 53 04	B
Cabinet with 7 drawers	
Dim. mm 1023x573x850 h Central lock	

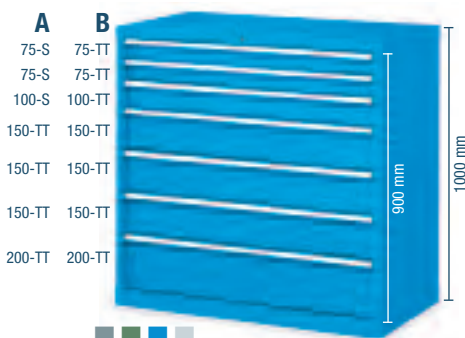

• ORD. NO.	TYPE
F AG 4040 06 04	A
F AG 4040 56 04	B
Cabinet with 7 drawers	
Dim. mm 1023x573x1000 h Central lock	

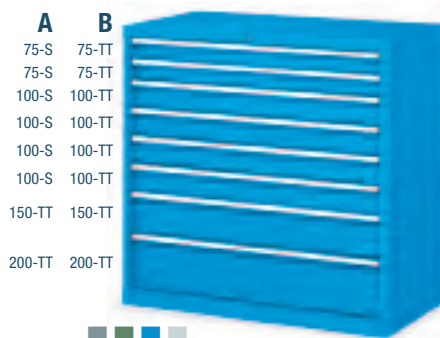

• ORD. NO.	TYPE
F AG 4040 02 04	A
F AG 4040 52 04	B
Cabinet with 8 drawers	
Dim. mm 1023x573x1000 h Central lock	

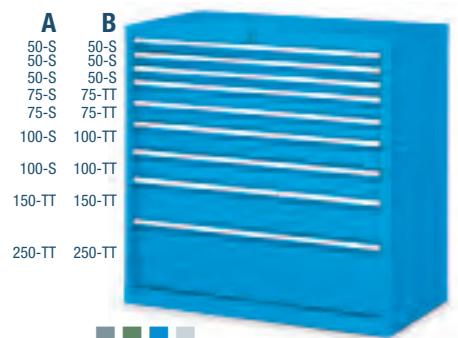

• ORD. NO.	TYPE
F AG 4040 03 04	A
F AG 4040 53 04	B
Cabinet with 9 drawers	
Dim. mm 1023x573x1000 h Central lock	

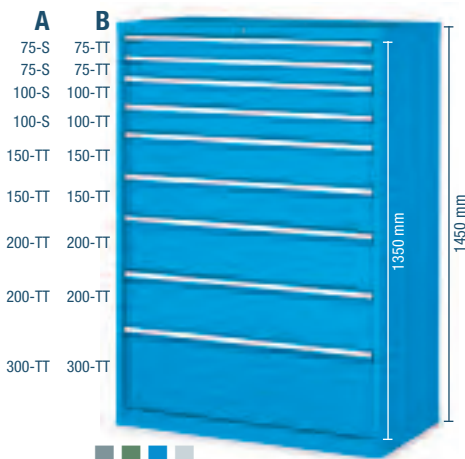

• ORD. NO.	TYPE
F AG 4058 01 04	A
F AG 4058 51 04	B
Cabinet with 9 drawers	
Dimensions mm 1023x573x1450 h Central lock	

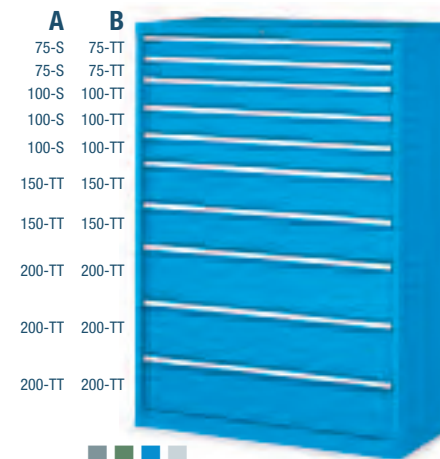

• ORD. NO.	TYPE
F AG 4058 05 04	A
F AG 4058 55 04	B
Cabinet with 10 drawers	
Dimensions mm 1023x573x1450 h Central lock	

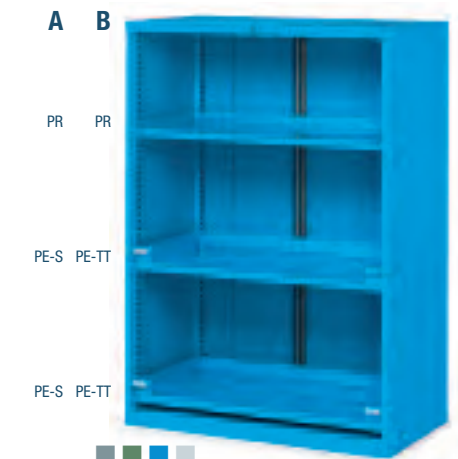

• ORD. NO.	TYPE
F AG 4058 08 04	A
F AG 4058 58 04	B
Cabinet with 2 retractable shelves, 1 adjust. shelf	
Dimensions mm 1023x573x1450 h Without lock, with anti-tilt rod	

KEY



- TT = telescopic full extension (100%)
- PE-TT = full telescopic retractable shelf (100%)
- S = normal extension (87%)
- PE-S = normal retractable shelf (87%)
- PR = height adjustable shelf

RAL 7000 F.01

RAL 6011 F.02

RAL 5012 F.04

RAL 7035 F.08

■ The cabinets must be secured to the floor or to the wall

■ Partitioning material: see page A113

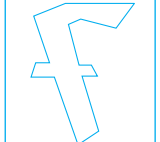

LENGTH = 1023 mm DEPTH = 573 mm (54x27 Eh)

CABINETS SERIES STANDARD GF

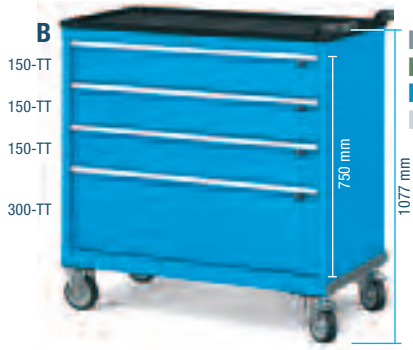

ORD. NO.	TYPE
—	
F AG S434 53 04	B
Cabinet with 4 drawers	
Cabinet load capacity: 370 kg	
Ø 125 mm elastic rubber wheels	
Dimensions mm 1098x574x1077 h	
Central lock	

ORD. NO.	TYPE
F AG S434 04 04	A
F AG S434 54 04	B
Cabinet with 5 drawers	
Cabinet load capacity: 370 kg	
Ø 125 mm elastic rubber wheels	
Dimensions mm 1098x574x1077 h	
Central lock	

ORD. NO.	TYPE
F AG S434 05 04	A
F AG S434 55 04	B
Cabinet with 6 drawers	
Cabinet load capacity: 370 kg	
Ø 125 mm elastic rubber wheels	
Dimensions mm 1098x574x1077 h	
Central lock	



ORD. NO.	TYPE
F AG S440 01 04	A
F AG S440 51 04	B
Cabinet with 6 drawers	
Cabinet load capacity: 370 kg	
Ø 125 mm elastic rubber wheels	
Dimensions mm 1098x574x1227 h	
Central lock	

ORD. NO.	TYPE
F AG S440 02 04	A
F AG S440 52 04	B
Cabinet with 7 drawers	
Cabinet load capacity: 370 kg	
Ø 125 mm elastic rubber wheels	
Dimensions mm 1098x574x1227 h	
Central lock	

RAL 7000 F.01 RAL 6011 F.02 RAL 5012 F.04 RAL 7035 F.08

KEY ■

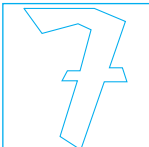

■ Partitioning material: see page A113

■ The handles can be fitted towards the bottom thereby reducing the height by 38 mm.

- TT = telescopic full extension (100%)
- S = normal extension (87%)
- All indicated loads are net and refer to evenly distributed weights



LENGTH = 1023 mm DEPTH = 573 mm (54x27 Eh)

CABINETS SERIES STANDARD GF

CABINET WITH WHEELS**ORD. NO.****F AG L434 S1 2Y**complete with 5 drawers,
1 rubber cover MDF top**Dimensions mm 1098x574x1091 h**

Tools and partitioning material excluded

■ RAL 3020



■ RAL 7035

CABINET**ORD. NO.****F AG 4040 S2 08**

6 drawers

1 rubber cover top with 3 edges

1 plinth for transpallet

Dimensions mm 1023x573x1120 h

Tools and partitioning material excluded

■ **INFO**

RAL 7000 F.01

RAL 6011 F.02

RAL 5012 F.04

RAL 7035 F.08

■ Partitioning
material: see
page **A180**
www.famispa.com

CABINETS SERIES STANDARD GF

EMPTY CABINETS

ORD. NO.	USABLE HEIGHT mm	LOAD CAPACITY kg	DIMENSIONS mm
F AG 4034 00 04	750	3100	1023x573x850 h
F AG 4040 00 04	900	3100	1023x573x1000 h
F AG 4058 00 04	1350	3100	1023x573x1450 h



SPARE LOCK
ORD. NO. R CSR 0003 00
for cabinet

■ 01 ■ 02 ■ 04 ■ 08

■ The cabinets must be secured to the floor or to the wall. If the cabinets are stacked they must be secured to the wall and their load capacity must be divided by 2. Further information for fixing set see page A106.

NORMAL EXTENSION DRAWERS (S)

ORD. NO.	FRONT HEIGHT mm	LOAD CAPACITY kg	USABLE DIMENSIONS mm
F FG 4005 00 04	50	60	906x447x36 h
F FG 4007 00 04	75	80	906x447x61 h
F FG 4010 00 04	100	100	906x447x86 h
F FG 4012 00 04	125	100	906x447x111 h

Normal extension (87%)



■ 01
■ 02
■ 04
■ 08

Partitioning material: see page A113

FULL TELESCOPIC EXTENSION DRAWERS (TT)

ORD. NO.	FRONT HEIGHT mm	LOAD CAPACITY kg	USABLE DIMENSIONS mm
F FG 4107 00 04	75	150	906x447x54 h
F FG 4110 00 04	100	150	906x447x79 h
F FG 4112 00 04	125	150	906x447x104 h
F FG 4115 00 04	150	150	906x447x129 h
F FG 4120 00 04	200	150	906x447x179 h
F FG 4125 00 04	250	150	906x447x229 h
F FG 4130 00 04	300	150	906x447x279 h

Full telescopic extension (100%)



■ 01
■ 02
■ 04
■ 08

■ Partitioning material: see page A113

NORMAL EXTENSION SHELVES (PE-S)

ORD. NO.	SIDE HEIGHT mm	LOAD CAPACITY kg	USABLE DIMENSIONS mm
F FG 8040 00 04	–	100	916x457

Normal extension (87%)



■ 01
■ 02
■ 04
■ 08

FULL TELESCOPIC EXTENSION SHELVES (PE-TT)

ORD. NO.	SIDE HEIGHT mm	LOAD CAPACITY kg	USABLE DIMENSIONS mm
F FG 8140 00 04	–	150	916x457

Full telescopic extension (100%)

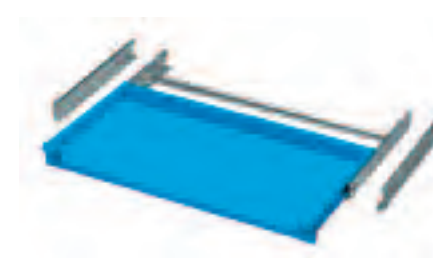

■ 01
■ 02
■ 04
■ 08

ADJUSTABLE SHELVES

ORD. NO.	SIDE HEIGHT mm	LOAD CAPACITY kg	USABLE DIMENSIONS mm
F SR 1220 01 04	25	100	967x465

Without extension system



■ 01
■ 02
■ 04
■ 08

RAL 7000 F.01

RAL 6011 F.02

RAL 5012 F.04

RAL 7035 F.08

KEY ■

■ All indicated loads are net and refer to evenly distributed weights



LENGTH = 1023 mm DEPTH = 573 mm (54x27 Eh)

CABINETS SERIES STANDARD GF

CABINET TO CABINET FIXING

■ The article includes:
4 M8 nuts and bolts

ORD. NO. F AG 9202 00 99



TWO SIDED ADHESIVE TAPE

ORD. NO.

R CMV 0025 00

width 15 mm, length 50 metres



■ 07

TOP SHELF

ORD. NO.

DIMENSIONS mm

F AG 9009 01 07

1023x573x20 h

oil-resistant rubber cover top with 3 edges



■ 07

PLINTHS

ORD. NO.

F RR 0090 00 07

Plinths height 50 mm



■ 07

ZOCOLI PER TRANSPALLET

ORD. NO.

F RR 0205 00 07 Plinths height 100 mm

F RR 0415 00 07 Facing piece



■ 07

PLINTHS FOR FORK LIFT TRUCK

ORD. NO.

F RR 0200 00 07 Pair of plinths height 60 mm

F RR 0410 00 07 Facing piece

UPPER MDF TOP WITH RUBBER COVERING DIMENSIONS 1024x573x31,5 mm H

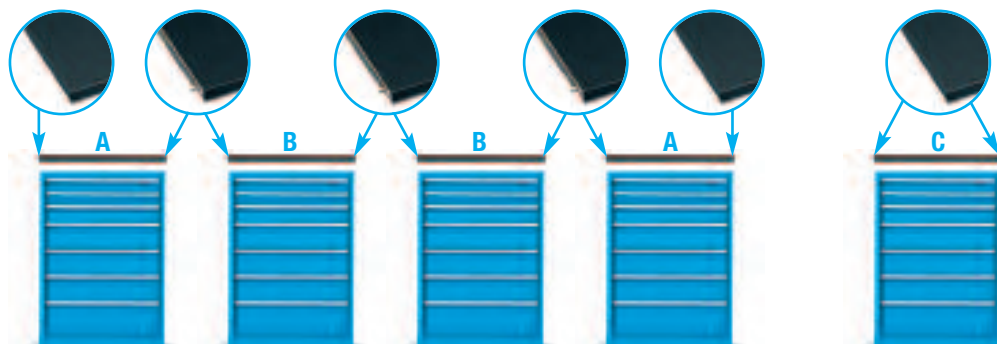

ORD. NO. F UZ 9999 00 00

Drilling of the cabinet upper shelf for the MDF top fixing.



Detail of the oil-resistant rubber

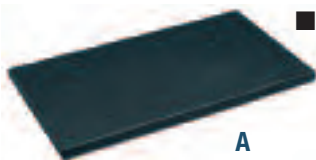

■ 07

A

ORD. NO.

F UZ 3090 11 07

MDF top with rubber covering

Side profile

For end cabinets

Oil-resistant rubber mat



■ 07

B

ORD. NO.

F UZ 3090 12 07

MDF top with rubber covering

No side profile

For additional central cabinets Oil-resist. rubber mat



■ 07

C

ORD. NO.

F UZ 3090 13 07

MDF top with rubber covering

2 side profiles

For single cabinet

Oil-resistant rubber mat

■ INFO

RAL 7000 F.01

RAL 6011 F.02

RAL 5012 F.04

RAL 7035 F.08



www.famispa.com



CABINETS SERIES STANDARD GF

CABINETS PREPARED FOR WHEELS

Cabinets prepared for wheels including: wheel plate, 4 edged top with oil-resistant rubber, 2 steel handles covered with shock-resistant rubber, cylinder lock with 2 keys, anti-tilt rod.

- 01
- 02
- 04
- 08



- 01
- 02
- 04
- 08



■ The single drawer opening system **ORD. NO. F DD 9400 00 07** must be applied to all drawers of mobile cabinets.

ORD. NO.

F AG 0434 00 04

Overall dim. mm:
1098x574x917 h without wheels

*Wheel plate thickness

ORD. NO.

F AG 0440 00 04

Overall dim. mm:
1098x574x1067 h without wheels

*Wheel plate thickness

■ Other types of wheels see page **A52**



ELASTIC RUBBER SWIVEL WHEEL WITH BRAKE

ORD. NO.	Ø mm	CABINET LOAD CAPACITY	C mm
C RG DCE15 125	125	370 kg	160



ELASTIC RUBBER FIXED WHEEL

ORD. NO.	Ø mm	CABINET LOAD CAPACITY	C mm
C RG BCE15 125	125	370 kg	160



NYLON SWIVEL WHEEL WITH BRAKE

ORD. NO.	Ø mm	CABINET LOAD CAPACITY	C mm
C RN DAD11 125	125	370 kg	160



NYLON FIXED WHEEL

ORD. NO.	Ø mm	CABINET LOAD CAPACITY	C mm
C RN BAD11 125	125	370 kg	160

RAL 7000 F.01

RAL 6011 F.02

RAL 5012 F.04

RAL 7035 F.08

KEY ■



■ The handles can be fitted towards the bottom thereby reducing the height by 38 mm.



■ All indicated loads are net and refer to evenly distributed weights



LENGTH = 1023 mm DEPTH = 573 mm (54x27 Eh)

CABINETS SERIES STANDARD GF

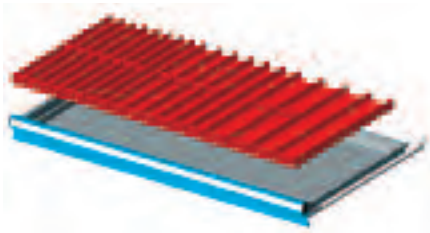

ORD. NO.	FOR FRONT HEIGHTS
----------	-------------------

F FH 4005 12 00	50-300
Set including:	
6 Troughs	4 grooves
15 Plain partitions	36 mm
6 Troughs	3 grooves
10 Plain partitions	47 mm
6 Troughs	2 grooves
6 Plain partitions	73 mm

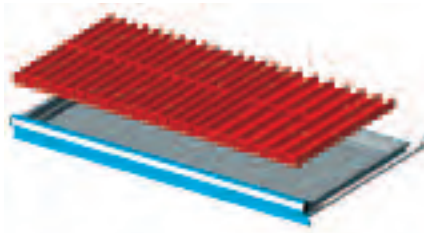

ORD. NO.	FOR FRONT HEIGHTS
----------	-------------------

F FH 4005 15 00	50-300
Set including:	
12 Troughs	4 grooves
30 Plain partitions	36 mm
6 Troughs	3 grooves
10 Plain partitions	47 mm

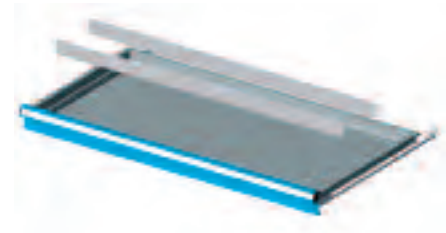

ORD. NO.	FOR FRONT HEIGHTS
----------	-------------------

F FH 4005 01 00	50
F FH 4007 01 00	75
F FH 4010 01 00	100-125
F FH 4015 01 00	150-175
F FH 4020 01 00	200-250
F FH 4030 01 00	300
Set including:	
2 Plain partitions	914 mm



ORD. NO.	FOR FRONT HEIGHTS
----------	-------------------

F FH 4005 03 00	50
F FH 4007 03 00	75
F FH 4010 03 00	100-125
F FH 4015 03 00	150-175
F FH 4020 03 00	200-250
Set including:	
5 Slotted partitions	455 mm
12 Plain partitions	149 mm

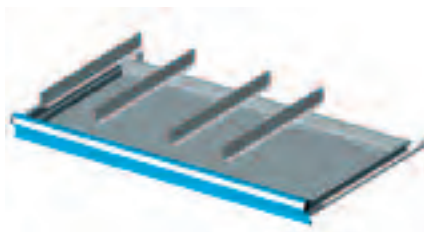

ORD. NO.	FOR FRONT HEIGHTS
----------	-------------------

F FH 4005 04 00	50
F FH 4007 04 00	75
F FH 4010 04 00	100-125
F FH 4015 04 00	150-175
F FH 4020 04 00	200-250
Set including:	
4 Plain partitions	455 mm

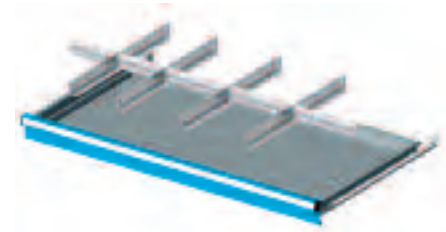

ORD. NO.	FOR FRONT HEIGHTS
----------	-------------------

F FH 4005 05 00	50
F FH 4007 05 00	75
F FH 4010 05 00	100-125
F FH 4015 05 00	150-175
F FH 4020 05 00	200-250
Set including:	
4 Slotted partitions	455 mm
2 Plain partitions	149 mm
3 Plain partitions	200 mm

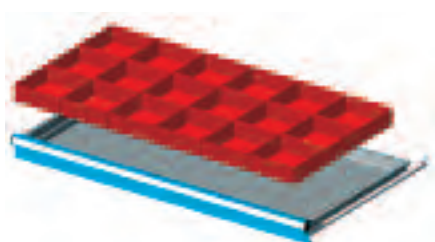

ORD. NO.	FOR FRONT HEIGHTS
----------	-------------------

F FH 4005 11 00	50
F FH 4007 11 00	75
F FH 4010 11 00	100-125
Set including:	
18 Plastic boxes	150x150 mm

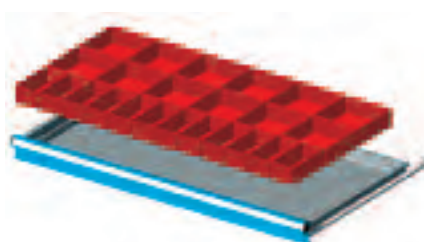

ORD. NO.	FOR FRONT HEIGHTS
----------	-------------------

F FH 4005 13 00	50
F FH 4007 13 00	75
F FH 4010 13 00	100-125
Set including:	
12 Plastic boxes	150x75 mm
12 Plastic boxes	150x150 mm

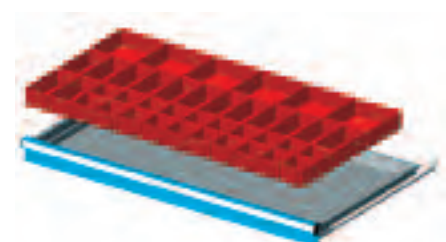

ORD. NO.	FOR FRONT HEIGHTS
----------	-------------------

F FH 4005 16 00	50
F FH 4007 16 00	75
Set including:	
20 Plastic boxes	75x75 mm
14 Plastic boxes	150x75 mm
6 Plastic boxes	150x150 mm

■ INFO

www.famispa.com

■ Partitioning material: see page A180

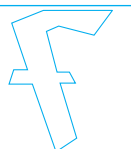

CABINETS SERIES STANDARD GB



ORD. NO. F AG 5040 S1 08
RAL 7035

ORD. NO. F AG L534 S1 50
RAL 7035+5012

54 EH (906 mm)

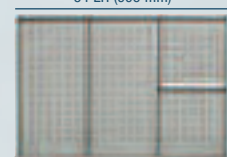

36 EH (600 mm)

FLOOR FIXING SET



2x

- 2 "HILTI" plugs for concrete floors ≥ to classes B25/RBK250/MPA 25 N/mm²
- Recommended traction of the plug: 2.9 KN
- Plug diameter: Ø 6 mm

ORD. NO. F AG 9204 00 99

CABINET FLOOR FIXING SET

- Pair of spare galvanised brackets
- Ø 6 mm hole



ORD. NO. F AG 9200 00 99

CABINET

ORD. NO.

F AG 5040 S1 08

Complete with 6 drawers,
1 rubber cover top with 3 edges

Dimensions mm 1023x726x1020 h

Tools and partitioning material excluded

CABINET WITH WHEELS

ORD. NO.

F AG L534 S1 50

Complete with 5 drawers,
1 multiplex worktop 40 mm thickness

Dimensions mm 1098x750x1101 h

RAL 7000 F.01

RAL 6011 F.02

RAL 5012 F.04

RAL 7035 F.08

SUPPLEMENTARY PARTS ■

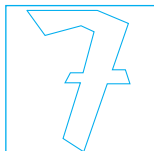

■ Partitioning material: see page A113



■ **Spare key.** Always indicate the number on the cylinder lock of the key to be replaced.

ORD. NO. R CSC 0002 00

■ **Master key.** This type of key opens all the 45 and 46 series locks.

ORD. NO. R CSC 0001 00



LENGTH = 1023 mm DEPTH = 726 mm (54x36 Eh)

CABINETS SERIES STANDARD GB



- | A | B |
|--------|--------|
| 100-S | 100-TT |
| 150-TT | 150-TT |
| 150-TT | 150-TT |
| 150-TT | 150-TT |
| 200-TT | 200-TT |

ORD. NO.	TYPE
F AG 5034 04 04	A
F AG 5034 54 04	B
Cabinet with 5 drawers	
Dimensions mm 1023x726x850 h	
Central lock	



- | A | B |
|--------|--------|
| 100-S | 100-TT |
| 100-S | 100-TT |
| 100-S | 100-TT |
| 150-TT | 150-TT |
| 300-TT | 300-TT |

ORD. NO.	TYPE
F AG 5034 07 04	A
F AG 5034 57 04	B
Cabinet with 5 drawers	
Dimensions mm 1023x726x850 h	
Central lock	



- | A | B |
|--------|--------|
| 75-S | 75-TT |
| 75-S | 75-TT |
| 100-S | 100-TT |
| 100-S | 100-TT |
| 150-TT | 150-TT |
| 250-TT | 250-TT |

ORD. NO.	TYPE
F AG 5034 08 04	A
F AG 5034 58 04	B
Cabinet with 6 drawers	
Dimensions mm 1023x726x850 h	
Central lock	



- | A | B |
|--------|--------|
| 50-S | 50-S |
| 75-S | 75-TT |
| 75-S | 75-TT |
| 100-S | 100-TT |
| 100-S | 100-TT |
| 100-S | 100-TT |
| 150-TT | 150-TT |
| 200-TT | 200-TT |

ORD. NO.	TYPE
F AG 5034 09 04	A
F AG 5034 59 04	B
Cabinet with 7 drawers	
Dimensions mm 1023x726x850 h	
Central lock	

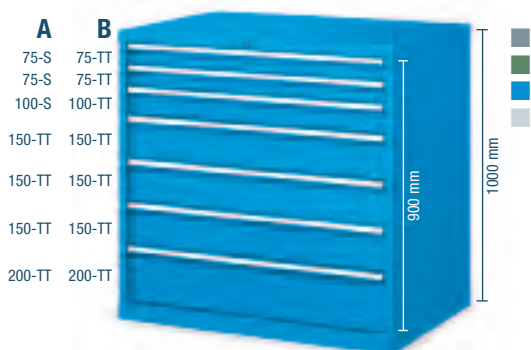

- | A | B |
|--------|--------|
| 75-S | 75-TT |
| 75-S | 75-TT |
| 100-S | 100-TT |
| 150-TT | 150-TT |
| 150-TT | 150-TT |
| 150-TT | 150-TT |
| 200-TT | 200-TT |

ORD. NO.	TYPE
F AG 5040 11 04	A
F AG 5040 61 04	B
Cabinet with 7 drawers	
Dimensions mm 1023x726x1000 h	
Central lock	

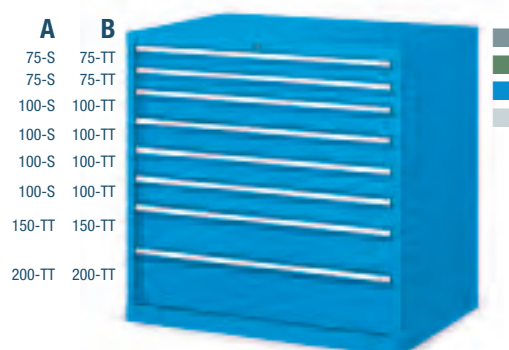

- | A | B |
|--------|--------|
| 75-S | 75-TT |
| 75-S | 75-TT |
| 100-S | 100-TT |
| 100-S | 100-TT |
| 100-S | 100-TT |
| 100-S | 100-TT |
| 150-TT | 150-TT |
| 200-TT | 200-TT |

ORD. NO.	TYPE
F AG 5040 05 04	A
F AG 5040 02 04	B
Cabinet with 8 drawers	
Dimensions mm 1023x726x1000 h	
Central lock	

KEY



- TT = telescopic full extension (100%)
- S = normal extension (87%)
- All indicated loads are net and refer to evenly distributed weights

RAL 7000 F.01 RAL 6011 F.02 RAL 5012 F.04 RAL 7035 F.08

■ Partitioning material: see page A113



LENGTH = 1023 mm DEPTH = 726 mm (54x36 Eh)

CABINETS SERIES STANDARD GB

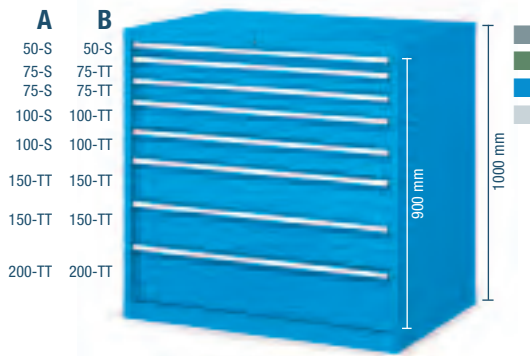

- | | |
|----------|----------|
| A | B |
| 50-S | 50-S |
| 75-S | 75-TT |
| 75-S | 75-TT |
| 100-S | 100-TT |
| 100-S | 100-TT |
| 150-TT | 150-TT |
| 150-TT | 150-TT |
| 200-TT | 200-TT |

ORD. NO.	TYPE
F AG 5040 08 04	A
F AG 5040 58 04	B
Cabinet with 8 drawers	
Dimensions mm 1023x726x1000 h	
Central lock	

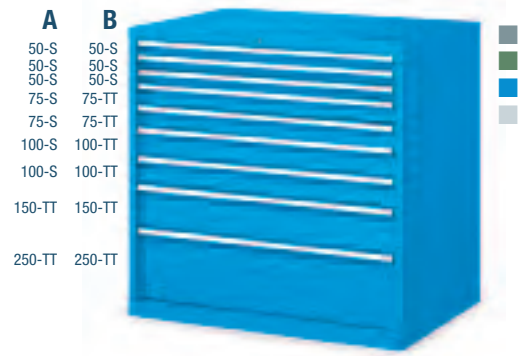

- | | |
|----------|----------|
| A | B |
| 50-S | 50-S |
| 50-S | 50-S |
| 50-S | 50-S |
| 75-S | 75-TT |
| 75-S | 75-TT |
| 100-S | 100-TT |
| 100-S | 100-TT |
| 150-TT | 150-TT |
| 250-TT | 250-TT |

ORD. NO.	TYPE
F AG 5040 12 04	A
F AG 5040 62 04	B
Cabinet with 9 drawers	
Dimensions mm 1023x726x1000 h	
Central lock	

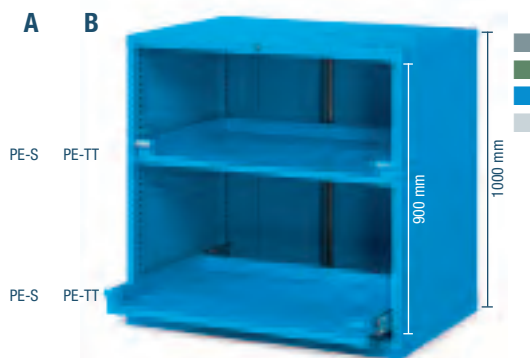

- | | |
|----------|----------|
| A | B |
| PE-S | PE-TT |
| PE-S | PE-TT |

ORD. NO.	TYPE
F AG 5040 15 04	A
F AG 5040 65 04	B
Cabinet with 2 retractable shelves	
Dimensions mm 1023x726x1000 h	
Without lock, with anti-tilt rod	



- | | |
|----------|----------|
| A | B |
| 100-S | 100-TT |
| 100-S | 100-TT |
| 100-S | 100-TT |
| 100-S | 100-TT |
| 125-S | 125-TT |
| 150-TT | 150-TT |
| 150-TT | 150-TT |
| 200-TT | 200-TT |
| 200-TT | 200-TT |

ORD. NO.	TYPE
F AG 5053 04 04	A
F AG 5053 01 04	B
Cabinet with 9 drawers	
Dimensions mm 1023x726x1325 h	
Central lock	

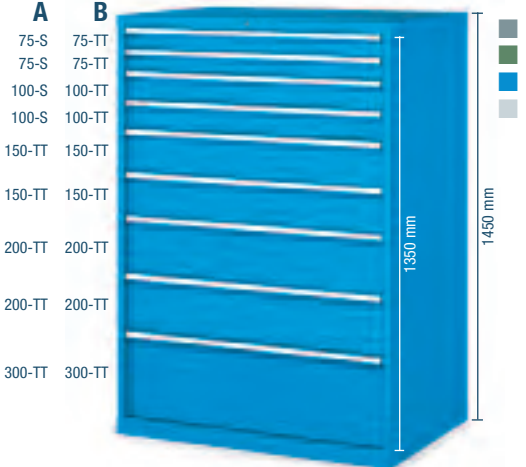

- | | |
|----------|----------|
| A | B |
| 75-S | 75-TT |
| 75-S | 75-TT |
| 100-S | 100-TT |
| 100-S | 100-TT |
| 150-TT | 150-TT |
| 150-TT | 150-TT |
| 200-TT | 200-TT |
| 200-TT | 200-TT |
| 300-TT | 300-TT |

ORD. NO.	TYPE
F AG 5058 07 04	A
F AG 5058 57 04	B
Cabinet with 9 drawers	
Dimensions mm 1023x726x1450 h	
Central lock	

RAL 7000 F.01 RAL 6011 F.02 RAL 5012 F.04 RAL 7035 F.08

KEY ■

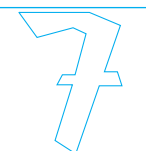

■ Partitioning material: see page A113

- TT = telescopic full extension (100%)
- PE-TT = full telescopic retractable shelf (100%)
- S = normal extension (87%)
- PE-S = normal retractable shelf (87%)
- The cabinets must be secured to the floor or to the wall



LENGTH = 1023 mm DEPTH = 726 mm (54x36 Eh)

CABINETS SERIES STANDARD GB

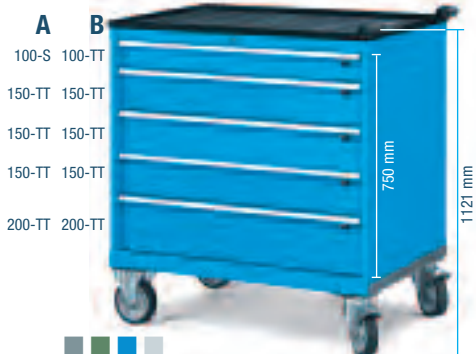

ORD. NO.	TYPE
F AG L534 02 04	A
F AG L534 52 04	B
Cabinet with 5 drawers	
Cabinet load capacity: 600 kg	
Ø 160 mm elastic rubber wheels	
Dimensions mm 1098x727x1121 h	
Central lock	



ORD. NO.	TYPE
F AG L534 05 04	A
F AG L534 55 04	B
Cabinet with 6 drawers	
Cabinet load capacity: 600 kg	
Ø 160 mm elastic rubber wheels	
Dimensions mm 1098x727x1271 h	
Central lock	



ORD. NO.	TYPE
F AG L540 01 04	A
F AG L540 51 04	B
Cabinet with 6 drawers	
Cabinet load capacity: 600 kg	
Ø 160 mm elastic rubber wheels	
Dimensions mm 1098x727x1271 h	
Central lock	



ORD. NO.	TYPE
F AG L540 02 04	A
F AG L540 52 04	B
Cabinet with 7 drawers	
Cabinet load capacity: 600 kg	
Ø 160 mm elastic rubber wheels	
Dimensions mm 1098x727x1271 h	
Central lock	



CABINET WITH WHEELS

ORD. NO.

F AG L534 S2 50

complete with 5 drawers,
1 multiplex worktop 40 mm thickness,
1 multi-purpose back panel with containers and 2x18W lamp

Dim. mm 1098x750x1041/2068 h Tools and partitioning material excluded

KEY

RAL 7000 F.01 RAL 6011 F.02 RAL 5012 F.04 RAL 7035 F.08



- TT = telescopic full extension (100%)
- S = normal extension (87%)
- All indicated loads are net and refer to evenly distributed weights



■ The handles can be fitted towards the bottom thereby reducing the height by 38 mm.

■ Partitioning material: see page A113



CABINETS SERIES STANDARD GB

EMPTY CABINETS

ORD. NO.	USABLE HEIGHT mm	LOAD CAPACITY kg	DIMENSIONS mm
F AG 5034 00 04	750	3100	1023x726x850 h
F AG 5040 00 04	900	3100	1023x726x1000 h
F AG 5053 00 04	1225	3100	1023x726x1325 h
F AG 5058 00 04	1350	3100	1023x726x1450 h



SPARE LOCK

ORD. NO. R CSR 0003 00
for cabinet

■ 01 ■ 02 ■ 04 ■ 08

■ The cabinets must be secured to the floor or to the wall. If the cabinets are stacked they must be secured to the wall and their load capacity must be divided by 2. Further information for fixing set see page A114.

NORMAL EXTENSION DRAWERS (S)

ORD. NO.	FRONT HEIGHT mm	LOAD CAPACITY kg	USABLE DIMENSIONS mm
F FG 5005 00 04	50	60	906x600x36 h
F FG 5007 00 04	75	80	906x600x61 h
F FG 5010 00 04	100	100	906x600x86 h
F FG 5012 00 04	125	100	906x600x111 h

Normal extension (87%)



■ 01
■ 02
■ 04
■ 08

■ Partitioning material: see page A121

FULL TELESCOPIC EXTENSION DRAWERS (TT)

ORD. NO.	FRONT HEIGHT mm	LOAD CAPACITY kg	USABLE DIMENSIONS mm
F FG 5107 00 04	75	150	906x600x54 h
F FG 5110 00 04	100	150	906x600x79 h
F FG 5112 00 04	125	150	906x600x104 h
F FG 5115 00 04	150	150	906x600x129 h
F FG 5117 00 04	175	150	906x600x154 h
F FG 5120 00 04	200	150	906x600x179 h
F FG 5125 00 04	250	150	906x600x229 h
F FG 5130 00 04	300	150	906x600x279 h

Full telescopic extension (100%)



■ 01
■ 02
■ 04
■ 08

■ Partitioning material: see page A121

NORMAL EXTENSION SHELVES (PE-S)

ORD. NO.	SIDE HEIGHT mm	LOAD CAPACITY kg	USABLE DIMENSIONS mm
F FG 8050 00 04	-	100	916x610

Normal extension (87%)



■ 01
■ 02
■ 04
■ 08

FULL TELESCOPIC EXTENSION SHELVES (PE-TT)

ORD. NO.	SIDE HEIGHT mm	LOAD CAPACITY kg	USABLE DIMENSIONS mm
F FG 8150 00 04	-	150	916x610

Full telescopic extension (100%)

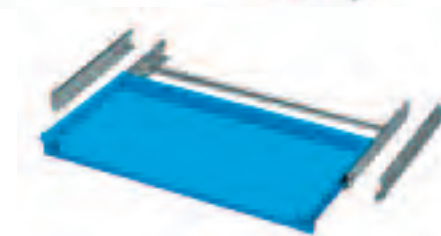

■ 01
■ 02
■ 04
■ 08

ADJUSTABLE SHELVES

ORD. NO.	SIDE HEIGHT mm	LOAD CAPACITY kg	USABLE DIMENSIONS mm
F SR 1270 01 04	25	100	967x618

Without extension system



■ 01
■ 02
■ 04
■ 08

RAL 7000 F.01 RAL 6011 F.02 RAL 5012 F.04 RAL 7035 F.08

KEY ■

■ All indicated loads are net and refer to evenly distributed weights



LENGTH = 1023 mm DEPTH = 726 mm (54x36 Eh)

CABINETS SERIES STANDARD GB

CABINET TO CABINET FIXING

■ The article includes:
4 M8 nuts and bolts

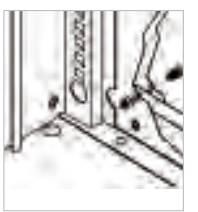

ORD. NO. F AG 9202 00 99



TWO SIDED ADHESIVE TAPE

ORD. NO.

R CMV 0025 00

width 15 mm, length 50 metres



■ 07

TOP SHELF

ORD. NO.

F AG 9012 01 07

DIMENSIONS mm

1023x726x20 h

oil-resistant rubber cover top with 3 edges

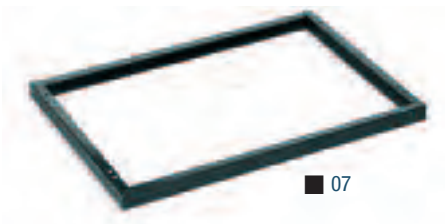

■ 07

PLINTHS

ORD. NO.

F RR 0095 00 07

Plinths height 50 mm



■ 07

PLINTHS FOR TRANSPALLET

ORD. NO.

F RR 0235 00 07 Plinths height 100 mm

F RR 0415 00 07 Facing piece



■ 07

PLINTHS FOR FORK LIFT TRUCK

ORD. NO.

F RR 0230 00 07 Pair of plinths height 60 mm

F RR 0410 00 07 Facing piece

UPPER MDF TOP WITH RUBBER COVERING DIMENSIONS 1024x726x31,5 mm H

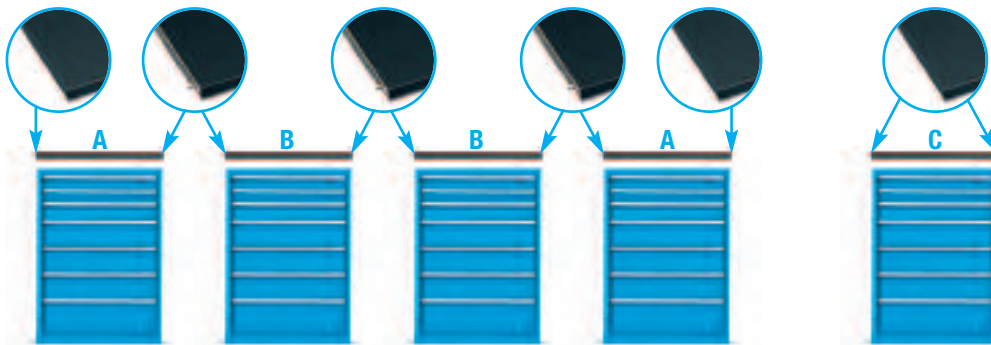

ORD. NO. F UZ 9999 00 00

Drilling of the cabinet upper shelf for the MDF top fixing.



Detail of the oil-resistant rubber

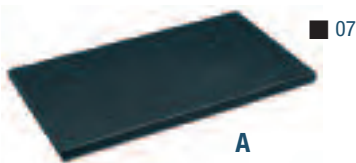

■ 07

A

ORD. NO.

F UZ 3240 11 07

MDF top with rubber covering

Side profile

For end cabinets

Oil-resistant rubber mat



■ 07

B

ORD. NO.

F UZ 3240 12 07

MDF top with rubber covering

No side profile

For additional central cabinets Oil-resist. rubber mat



■ 07

C

ORD. NO.

F UZ 3240 13 07

MDF top with rubber covering

2 side profiles

For single cabinet

Oil-resistant rubber mat

■ **INFO**

RAL 7000 F.01

RAL 6011 F.02

RAL 5012 F.04

RAL 7035 F.08



www.famispa.com

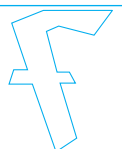

CABINETS SERIES STANDARD GB

CABINETS PREPARED FOR WHEELS

Cabinets prepared for wheels including: wheel plate, 4 edged top with oil-resistant rubber, 2 steel handles covered with shock-resistant rubber, cylinder lock with 2 keys, anti-tilt rod.



- 01
- 02
- 04
- 08



- 01
- 02
- 04
- 08

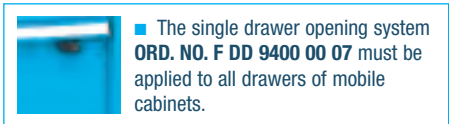

■ The single drawer opening system **ORD. NO. F DD 9400 00 07** must be applied to all drawers of mobile cabinets.

ORD. NO.

F AG 0534 00 04

Overall dim. mm:
1098x727x917 h senza ruote
*Wheel plate thickness

ORD. NO.

F AG 0540 00 04

Overall dim. mm:
1098x727x1067 h senza ruote
*Wheel plate thickness

■ Other types of wheels see page A52

ELASTIC RUBBER SWIVEL WHEEL WITH BRAKE

ORD. NO.	Ø mm	CABINET LOAD CAPACITY	C mm
C RG DCE15 160	160	600 kg	204

ELASTIC RUBBER FIXED WHEEL

ORD. NO.	Ø mm	CABINET LOAD CAPACITY	C mm
C RG BCE15 160	160	600 kg	204

NYLON SWIVEL WHEEL WITH BRAKE

ORD. NO.	Ø mm	CABINET LOAD CAPACITY	C mm
C RN DAD04 160	160	600 kg	204

NYLON FIXED WHEEL

ORD. NO.	Ø mm	CABINET LOAD CAPACITY	C mm
C RN BAD04 160	160	600 kg	204

EXAMPLE INCLUDING:

ORD. NO.

F AG 5053 58 50

2 retractable shelves

Dimensions mm **1023x726x1325 h**

Polypropylene stacking containers excluded

- RAL 7035 +
- RAL 5012



KEY ■

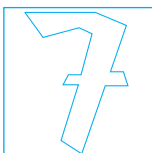

■ Partitioning material: see page A180

■ The handles can be fitted towards the bottom thereby reducing the height by 38 mm.



■ All indicated loads are net and refer to evenly distributed weights



LENGTH = 1023 mm DEPTH = 726 mm (54x36 Eh)

CABINETS SERIES STANDARD GB

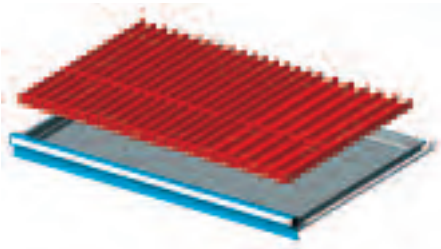

ORD. NO.	FOR FRONT HEIGHTS
----------	-------------------

F FH 5005 19 00	50-300
Set including:	
16 Troughs	4 grooves
30 Plain partitions	36 mm
8 Troughs	3 grooves
10 Plain partitions	47 mm

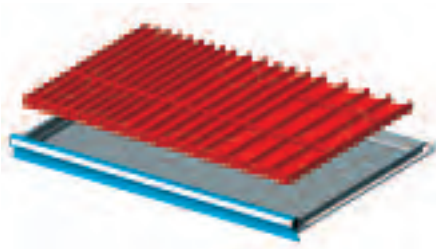

ORD. NO.	FOR FRONT HEIGHTS
----------	-------------------

F FH 5005 09 00	50-300
Set including:	
8 Troughs	4 grooves
15 Plain partitions	36 mm
8 Troughs	3 grooves
10 Plain partitions	47 mm
8 Troughs	2 grooves
6 Plain partitions	73 mm

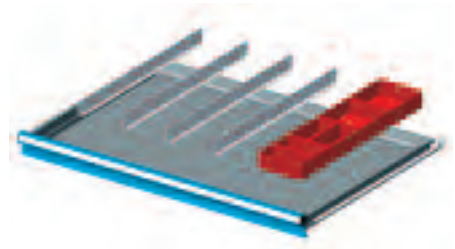

ORD. NO.	FOR FRONT HEIGHTS
----------	-------------------

F FH 5005 05 00	50
F FH 5007 05 00	75
F FH 5010 05 00	100-125
Set including:	
5 Plain partitions	610 mm
4 Plastic boxes	150x75 mm
2 Plastic boxes	150x150 mm

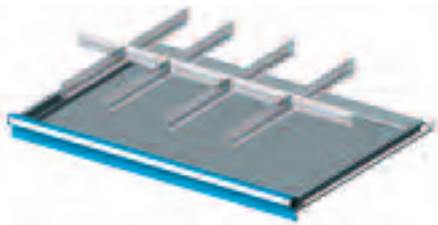

ORD. NO.	FOR FRONT HEIGHTS
----------	-------------------

F FH 5005 07 00	50
F FH 5007 07 00	75
F FH 5010 07 00	100-125
F FH 5015 07 00	150-175
F FH 5020 07 00	200-250
F FH 5030 07 00	300
Set including:	
4 Slotted partitions	610 mm
2 Plain partitions	149 mm
3 Plain partitions	200 mm

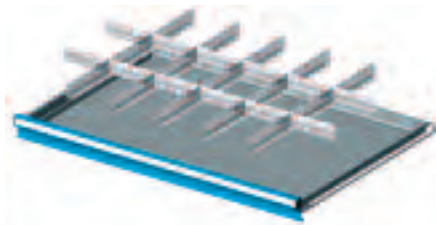

ORD. NO.	FOR FRONT HEIGHTS
----------	-------------------

F FH 5005 13 00	50
F FH 5007 13 00	75
F FH 5010 13 00	100-125
F FH 5015 13 00	150-175
F FH 5020 13 00	200-250
F FH 5030 13 00	300
Set including:	
5 Slotted partitions	610 mm
12 Plain partitions	149 mm



ORD. NO.	FOR FRONT HEIGHTS
----------	-------------------

F FH 5005 14 00	50
F FH 5007 14 00	75
F FH 5010 14 00	100-125
Set including:	
6 Slotted partitions	610 mm
6 Plain partitions	98 mm
3 Plain partitions	149 mm
1 Plain partition	200 mm

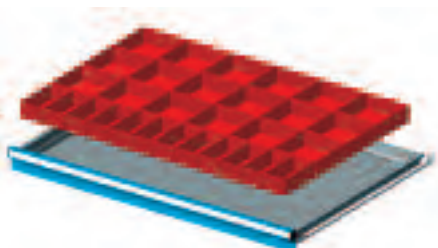

ORD. NO.	FOR FRONT HEIGHTS
----------	-------------------

F FH 5005 08 00	50
F FH 5007 08 00	75
F FH 5010 08 00	100-125
Set including:	
12 Plastic boxes	150x75 mm
18 Plastic boxes	150x150 mm

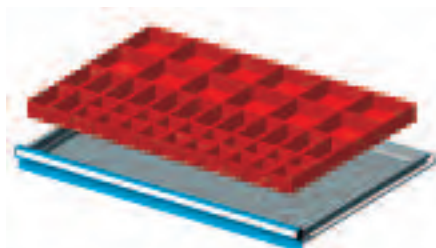

ORD. NO.	FOR FRONT HEIGHTS
----------	-------------------

F FH 5005 17 00	50
F FH 5007 17 00	75
Set including:	
20 Plastic boxes	75x75 mm
14 Plastic boxes	150x75 mm
12 Plastic boxes	150x150 mm

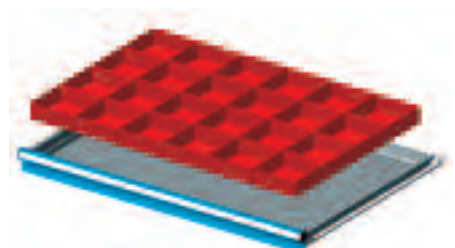

ORD. NO.	FOR FRONT HEIGHTS
----------	-------------------

F FH 5005 18 00	50
F FH 5007 18 00	75
F FH 5010 18 00	100-125
Set including:	
24 Plastic boxes	150x150 mm

■ INFO

www.famispa.com

■ Partitioning material: see page A180

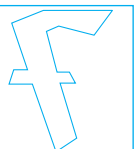

CABINETS SERIES STANDARD GC



ORD. NO. F AG 6034 S1 2Y
RAL 3020

64 EH (1076 mm)

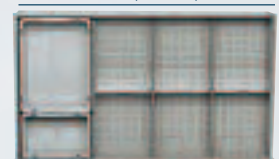

36 EH (600 mm)

FLOOR FIXING SET

2x

- 2 "HILTI" plugs for concrete floors \geq to classes B25/RBK250/MPa 25 N/mm²
- Recommended traction of the plug: 2.9 KN
- Plug diameter: \varnothing 6 mm

ORD. NO. F AG 9204 00 99

CABINET FLOOR FIXING SET

- Pair of spare galvanised brackets
- \varnothing 6 mm hole



ORD. NO. F AG 9200 00 99

CABINET**ORD. NO.****F AG 6034 S1 2Y**

Complete with 5 drawers,
1 rubber cover MDF top,
1 plinth for transpallet

Dimensions mm 1193x726x980 h

Tools and partitioning material excluded

RAL 7000 F.01

RAL 6011 F.02

RAL 5012 F.04

RAL 7035 F.08

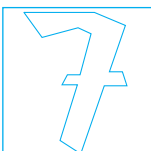
SUPPLEMENTARY PARTS ■

■ Partitioning material: see page A129



■ **Spare key.** Always indicate the number on the cylinder lock of the key to be replaced.

ORD. NO. R CSC 0002 00

■ **Master key.** This type of key opens all the 45 and 46 series locks.

ORD. NO. R CSC 0001 00



LENGTH = 1193 mm DEPTH = 726 mm (64x36 Eh)

CABINETS SERIES STANDARD GC



ORD. NO.

DRAWERS

F AG 6034 01 04**5**

Cabinet with 5 full telescopic extension drawers

Dimensions mm 1193x726x850 h

Central lock



ORD. NO.

DRAWERS

F AG 6034 02 04**6**

Cabinet with 6 full telescopic extension drawers

Dimensions mm 1193x726x850 h

Central lock



ORD. NO.

DRAWERS

F AG 6040 01 04**7**

Cabinet with 7 full telescopic extension drawers

Dimensions mm 1193x726x1000 h

Central lock



ORD. NO.

DRAWERS

F AG 6040 02 04**8**

Cabinet with 8 full telescopic extension drawers

Dimensions mm 1193x726x1000 h

Central lock



ORD. NO.

DRAWERS

F AG 6040 03 04**8**

Cabinet with 8 full telescopic extension drawers

Dimensions mm 1193x726x1000 h

Central lock



ORD. NO.

DRAWERS

F AG 6040 04 04**1**

Cabinet with 1 drawer, 2 retractable shelves

Dimensions mm 1193x726x1000 h

Without lock, with anti-tilt rod



- TT = telescopic full extension (100%)
- PE-TT = full telescopic retractable shelf (100%)
- The cabinets must be secured to the floor or to the wall

KEY

RAL 7000 F.01

RAL 6011 F.02

RAL 5012 F.04

RAL 7035 F.08

■ Partitioning material: see page A129



LENGTH = 1193 mm DEPTH = 726 mm (64x36 Eh)

CABINETS SERIES STANDARD GC



• ORD. NO.

DRAWERS

F AG 6053 01 04**9**

Cabinet with 9 full telescopic extension drawers

Dimensions mm 1193x726x1325 h

Central lock



• ORD. NO.

DRAWERS

F AG 6053 02 04**10**

Cabinet with 10 full telescopic extension drawers

Dimensions mm 1193x726x1325 h

Central lock

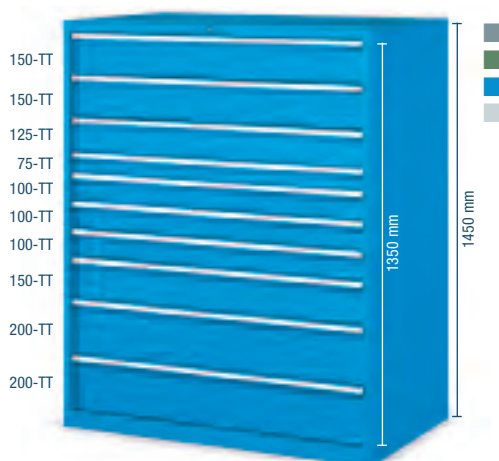

• ORD. NO.

DRAWERS

F AG 6058 01 04**10**

Cabinet with 10 full telescopic extension drawers

Dimensions mm 1193x726x1450 h

Central lock



ORD. NO.

SHELVES

F AG 6058 04 04**3**

Cabinet with 1 adjustable shelf, 2 retractable shelves

Dimensions mm 1193x726x1450 h

Without lock, with anti-tilt rod

RAL 7000 F.01

RAL 6011 F.02

RAL 5012 F.04

RAL 7035 F.08

KEY ■

- TT = telescopic full extension (100%)
- PE-TT = full telescopic retractable shelf (100%)
- PR = height adjustable shelf
- The cabinets must be secured to the floor or to the wall



LENGTH = 1193 mm DEPTH = 726 mm (64x36 Eh)

CABINETS SERIES STANDARD GC



ORD. NO.

DRAWERS

F AG L634 02 04**4**

Cabinet with 4 full telescopic extension drawers

Cabinet load capacity: 600 kg

Ø 160 mm elastic rubber wheels

Dimensions mm 1268x727x1121 h

Central lock



ORD. NO.

DRAWERS

F AG L634 01 04**5**

Cabinet with 5 full telescopic extension drawers

Cabinet load capacity: 600 kg

Ø 160 mm elastic rubber wheels

Dimensions mm 1268x727x1121 h

Central lock



ORD. NO.

DRAWERS

F AG L640 01 04**6**

Cabinet with 6 full telescopic extension drawers

Cabinet load capacity: 600 kg

Ø 160 mm elastic rubber wheels

Dimensions mm 1268x727x1271 h

Central lock



ORD. NO.

DRAWERS

F AG L640 02 04**7**

Cabinet with 7 full telescopic extension drawers

Cabinet load capacity: 600 kg

Ø 160 mm elastic rubber wheels

Dimensions mm 1268x727x1271 h

Central lock

KEY

RAL 7000 F.01 RAL 6011 F.02 RAL 5012 F.04 RAL 7035 F.08



- TT = telescopic full extension (100%)
- All indicated loads are net and refer to evenly distributed weights



- The handles can be fitted towards the bottom thereby reducing the height by 38 mm.

- Partitioning material: see page A129



CABINETS SERIES STANDARD GC

LENGTH = 1193 mm DEPTH = 726 mm (64x36 Eh)

EMPTY CABINETS

ORD. NO.	USABLE HEIGHT mm	LOAD CAPACITY kg	DIMENSIONS mm
F AG 6034 00 04	750	3100	1193x726x850 h
F AG 6040 00 04	900	3100	1193x726x1000 h
F AG 6053 00 04	1225	3100	1193x726x1325 h
F AG 6058 00 04	1350	3100	1193x726x1450 h

■ The cabinets must be secured to the floor or to the wall. If the cabinets are stacked they must be secured to the wall and their load capacity must be divided by 2. Further information for fixing set see page A122.



SPARE LOCK

ORD. NO.
R CSR 0003 00
for cabinet

■ 01 ■ 02 ■ 04 ■ 08

FULL TELESCOPIC EXTENSION DRAWERS (TT)

ORD. NO.	FRONT HEIGHT mm	LOAD CAPACITY kg	USABLE DIMENSIONS mm
F FG 6107 00 04	75	150	1076x600x54 h
F FG 6110 00 04	100	150	1076x600x79 h
F FG 6112 00 04	125	150	1076x600x104 h
F FG 6115 00 04	150	150	1076x600x129 h
F FG 6120 00 04	200	150	1076x600x179 h
F FG 6125 00 04	250	150	1076x600x229 h
F FG 6130 00 04	300	150	1076x600x279 h

Full telescopic extension (100%)



■ 01
■ 02
■ 04
■ 08

■ Partitioning material: see page A129

FULL TELESCOPIC EXTENSION SHELVES (PE-TT)

ORD. NO.	SIDE HEIGHT mm	LOAD CAPACITY kg	USABLE DIMENSIONS mm
F FG 8160 00 04	—	150	1086x610 h

Full telescopic extension (100%)



■ 01
■ 02
■ 04
■ 08

ADJUSTABLE SHELVES

ORD. NO.	SIDE HEIGHT mm	LOAD CAPACITY kg	USABLE DIMENSIONS mm
F SR 1280 01 04	35	150	1137x618

Without extension system



■ 01
■ 02
■ 04
■ 08

CABINET TO CABINET FIXING

■ The article includes:
4 M8 nuts and bolts

ORD. NO. F AG 9202 00 99

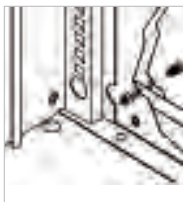

TWO SIDED ADHESIVE TAPE

ORD. NO.

R CMV 0025 00

width 15 mm, length 50 metres



■ 07

TOP SHELF

ORD. NO.

DIMENSIONS mm

F AG 9015 01 07 1193x726x20 h

oil-resistant rubber cover top with 3 edges



■ 07

PLINTHS

ORD. NO.

F RR 0100 00 07

Plinths height 50 mm



■ 07

PLINTHS FOR TRANSPALLET

ORD. NO.

F RR 0235 00 07 Plinths height 100 mm

F RR 0435 00 07 Facing piece



■ 07

PLINTHS FOR FORK LIFT TRUCK

ORD. NO.

F RR 0230 00 07 Pair of plinths height 60 mm

F RR 0430 00 07 Facing piece

LENGTH = 1193 mm DEPTH = 726 mm (64x36 Eh)

CABINETS SERIES STANDARD GC

UPPER MDF TOP WITH RUBBER COVERING DIMENSIONS 1194x726x31,5 mm H

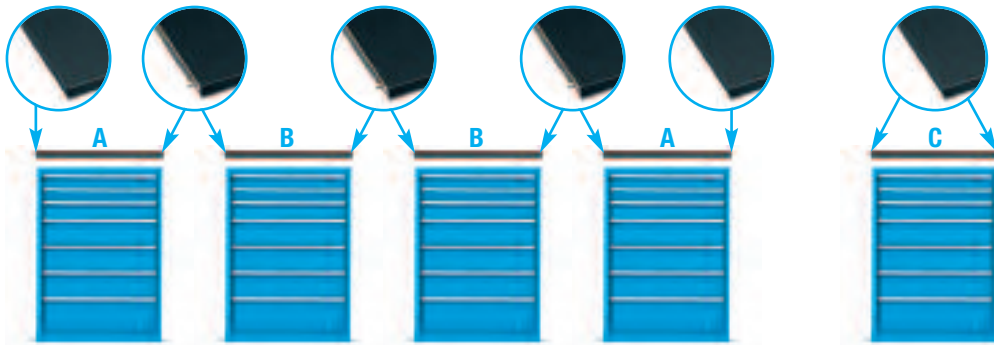

ORD. NO. F UZ 9998 00 00

Drilling of the cabinet upper shelf for the MDF top fixing.



Detail of the oil-resistant rubber



A



B



C

ORD. NO.

F UZ 3250 11 07

MDF top with rubber covering

Side profile

For end cabinets

Oil-resistant rubber mat

ORD. NO.

F UZ 3250 12 07

MDF top with rubber covering

No side profile

For additional central cabinets

Oil-resist. rubber mat

ORD. NO.

F UZ 3250 13 07

MDF top with rubber covering

2 side profiles

For single cabinet

Oil-resistant rubber mat

CABINETS PREPARED FOR WHEELS

Cabinets prepared for wheels including: wheel plate, 4 edged top with oil-resistant rubber, 2 steel handles covered with shock-resistant rubber, cylinder lock with 2 keys, anti-tilt rod.

- 01
- 02
- 04
- 08



- 01
- 02
- 04
- 08



ORD. NO.

F AG 0634 00 04

Overall dim. mm:

1268x727x917 h without wheels

*Wheel plate thickness

ORD. NO.

F AG 0640 00 04

Overall dim. mm:

1268x727x1067 h without wheels

*Wheel plate thickness



The single drawer opening system ORD. NO. F DD 9400 00 07 must be applied to all drawers of mobile cabinets.

Other types of wheels see page A52

ELASTIC RUBBER SWIVEL WHEEL WITH BRAKE

ORD. NO. Ø mm CABINET LOAD CAPACITY C mm

C RG DCE15 160 160 600 kg 204

ELASTIC RUBBER FIXED WHEEL

ORD. NO. Ø mm CABINET LOAD CAPACITY C mm

C RG BCE15 160 160 600 kg 204

NYLON SWIVEL WHEEL WITH BRAKE

ORD. NO. Ø mm CABINET LOAD CAPACITY C mm

C RN DAD04 160 160 600 kg 204

NYLON FIXED WHEEL

ORD. NO. Ø mm CABINET LOAD CAPACITY C mm

C RN BAD04 160 160 600 kg 204

KEY

- RAL 7000 F.01
- RAL 6011 F.02
- RAL 5012 F.04
- RAL 7035 F.08



All indicated loads are net and refer to evenly distributed weights



The handles can be fitted towards the bottom thereby reducing the height by 38 mm.

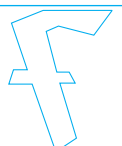

CABINETS SERIES STANDARD GC

ORD. NO. F BL 1020 00 00

Steel vice 130 mm

**CABINET WITH WHEELS****ORD. NO.****F AG L634 S1 2Y**

complete with 5 drawers

1 multiplex worktop 40 mm thickness

Dimensions mm 1268x750x1101 h

Tools and partitioning material excluded

■ RAL 3020

RAL 7000 F.01

RAL 6011 F.02

RAL 5012 F.04

RAL 7035 F.08

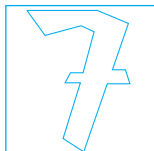
INFO ■

■ Partitioning material: see page **A180**

www.famispa.com



LENGTH = 1193 mm DEPTH = 726 mm (64x36 Eh)

CABINETS SERIES STANDARD GC

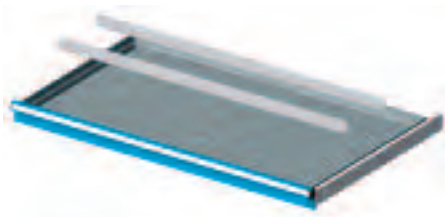

ORD. NO.	FOR FRONT HEIGHTS
----------	-------------------

F FH 6007 10 00	75
F FH 6010 10 00	100-125
F FH 6015 10 00	150-175
F FH 6020 10 00	200-250
F FH 6030 10 00	300

Set including:
2 Plain partitions 1085 mm



ORD. NO.	FOR FRONT HEIGHTS
----------	-------------------

F FH 6007 09 00	75
F FH 6010 09 00	100-125
F FH 6015 09 00	150-175
F FH 6020 09 00	200-250
F FH 6030 09 00	300

Set including:
4 Plain partitions 1085 mm



ORD. NO.	FOR FRONT HEIGHTS
----------	-------------------

F FH 6007 02 00	75
F FH 6010 02 00	100-125
F FH 6015 02 00	150-175
F FH 6020 02 00	200-250

Set including:
4 Slotted partitions 610 mm
3 Plain partitions 149 mm
3 Plain partitions 166 mm
9 Plain partitions 251 mm



ORD. NO.	FOR FRONT HEIGHTS
----------	-------------------

F FH 6007 11 00	75
F FH 6010 11 00	100-125
F FH 6015 11 00	150-175
F FH 6020 11 00	200-250
F FH 6030 11 00	300

Set including:
6 Slotted partitions 610 mm
6 Plain partitions 149 mm
1 Plain partition 166 mm

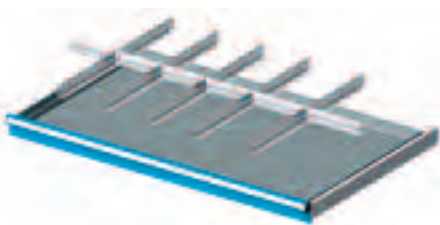

ORD. NO.	FOR FRONT HEIGHTS
----------	-------------------

F FH 6007 08 00	75
F FH 6010 08 00	100-125
F FH 6015 08 00	150-175
F FH 6020 08 00	200-250
F FH 6030 08 00	300

Set including:
5 Slotted partitions 610 mm
2 Plain partitions 149 mm
1 Plain partition 166 mm
3 Plain partitions 200 mm

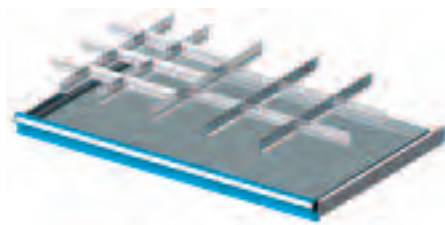

ORD. NO.	FOR FRONT HEIGHTS
----------	-------------------

F FH 6007 05 00	75
F FH 6010 05 00	100-125
F FH 6015 05 00	150-175

Set including:
5 Slotted partitions 610 mm
6 Plain partitions 132 mm
9 Plain partitions 200 mm



■ INFO

■ Partitioning material: see page A180



www.famispa.com



CABINETS SERIES STANDARD GD

ORD. NO. F BL 1020 00 00
Steel vice 130 mm



ORD. NO. F AG 7034 S1 56
RAL 7035+7000

78 EH (1314 mm)



36 EH (600 mm)

FLOOR FIXING SET



2x

- 2 "HILTI" plugs for concrete floors \geq to classes B25/RBK250/MPa 25 N/mm²
- Recommended traction of the plug: 2.9 KN
- Plug diameter: \varnothing 6 mm

ORD. NO. F AG 9204 00 99

CABINET FLOOR FIXING SET

- Pair of spare galvanised brackets
- \varnothing 6 mm hole



ORD. NO. F AG 9200 00 99

CABINET

ORD. NO.

F AG 7034 S1 56

Complete with 7 drawers

1 multiplex worktop 40 mm thickness

1 plinth for transpallet

Dimensions mm 1500x750x990 h

Tools and partitioning material excluded

RAL 7000 F.01

RAL 6011 F.02

RAL 5012 F.04

RAL 7035 F.08

SUPPLEMENTARY PARTS ■

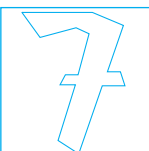

- Partitioning material: see page A137



- **Spare key.** Always indicate the number on the cylinder lock of the key to be replaced.

ORD. NO. R CSC 0002 00

- **Master key.** This type of key opens all the 45 and 46 series locks.

ORD. NO. R CSC 0001 00



LENGTH = 1431 mm DEPTH = 726 mm (78x36 Eh)

CABINETS SERIES STANDARD GD



ORD. NO.	DRAWERS
F AG 7034 01 04	5
Cabinet with 5 full telescopic extension drawers	
Dimensions mm 1431x726x850 h	
Central lock	



ORD. NO.	DRAWERS
F AG 7034 02 04	6
Cabinet with 6 full telescopic extension drawers	
Dimensions mm 1431x726x850 h	
Central lock	

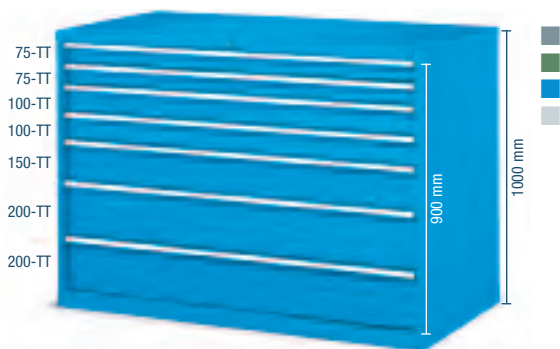

ORD. NO.	DRAWERS
F AG 7040 01 04	7
Cabinet with 7 full telescopic extension drawers	
Dimensions mm 1431x726x1000 h	
Central lock	



ORD. NO.	DRAWERS
F AG 7040 02 04	8
Cabinet with 8 full telescopic extension drawers	
Dimensions mm 1431x726x1000 h	
Central lock	



ORD. NO.	DRAWERS
F AG 7040 03 04	8
Cabinet with 8 full telescopic extension drawers	
Dimensions mm 1431x726x1000 h	
Central lock	



ORD. NO.	SHELVES
F AG 7040 05 04	2
Cabinet with 2 retractable shelves	
Dimensions mm 1431x726x1000 h	
Without lock, with anti-tilt rod	

KEY



- TT = telescopic full extension (100%)
- PE-TT = full telescopic retractable shelf (100%)
- The cabinets must be secured to the floor or to the wall

RAL 7000 F.01 RAL 6011 F.02 RAL 5012 F.04 RAL 7035 F.08

■ Partitioning material: see page A137



CABINETS SERIES STANDARD GD



•ORD. NO.	DRAWERS
F AG 7053 01 04	9
Cabinet with 9 full telescopic extension drawers	
Dimensions mm 1431x726x1325 h	
Central lock	



•ORD. NO.	DRAWERS
F AG 7053 02 04	10
Cabinet with 10 full telescopic extension drawers	
Dimensions mm 1431x726x1325 h	
Central lock	



•ORD. NO.	DRAWERS
F AG 7058 01 04	10
Cabinet with 10 full telescopic extension drawers	
Dimensions mm 1431x726x1450 h	
Central lock	



ORD. NO.	SHELVES
F AG 7058 04 04	3
Cabinet with 1 adjustable shelf, 2 retractable shelves	
Dimensions mm 1431x726x1450 h	
Without lock, with anti-tilt rod	

RAL 7000 F.01 RAL 6011 F.02 RAL 5012 F.04 RAL 7035 F.08

KEY ■

- TT = telescopic full extension (100%)
- PE-TT = full telescopic retractable shelf (100%)
- PR = height adjustable shelf
- The cabinets must be secured to the floor or to the wall

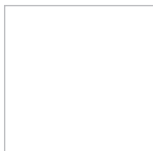

■ Partitioning material: see page A137

LENGTH = 1431 mm DEPTH = 726 mm (78x36 Eh)

CABINETS SERIES STANDARD GD



ORD. NO.

DRAWERS

F AG L734 02 04**4**

Cabinet with 4 full telescopic extension drawers

Cabinet load capacity: 600 kg

Ø 160 mm elastic rubber wheels

Dimensions mm 1506x727x1121 h

Central lock



ORD. NO.

DRAWERS

F AG L734 01 04**5**

Cabinet with 5 full telescopic extension drawers

Cabinet load capacity: 600 kg

Ø 160 mm elastic rubber wheels

Dimensions mm 1506x727x1121 h

Central lock



ORD. NO.

DRAWERS

F AG L740 01 04**6**

Cabinet with 6 full telescopic extension drawers

Cabinet load capacity: 600 kg

Ø 160 mm elastic rubber wheels

Dimensions mm 1506x727x1271 h

Central lock



ORD. NO.

DRAWERS

F AG L740 02 04**7**

Cabinet with 7 full telescopic extension drawers

Cabinet load capacity: 600 kg

Ø 160 mm elastic rubber wheels

Dimensions mm 1506x727x1271 h

Central lock

KEY

RAL 7000 F.01 RAL 6011 F.02 RAL 5012 F.04 RAL 7035 F.08



- TT = telescopic full extension (100%)
- All indicated loads are net and refer to evenly distributed weights



- The handles can be fitted towards the bottom thereby reducing the height by 38 mm.

- Partitioning material: see page A137



CABINETS SERIES STANDARD GD

EMPTY CABINETS

ORD. NO.	USABLE HEIGHT mm	LOAD CAPACITY kg	DIMENSIONS mm
F AG 7034 00 04	750	3100	1431x726x850 h
F AG 7040 00 04	900	3100	1431x726x1000 h
F AG 7053 00 04	1225	3100	1431x726x1325 h
F AG 7058 00 04	1350	3100	1431x726x1450 h



SPARE LOCK

ORD. NO.
R CSR 0003 00
for cabinet

■ The cabinets must be secured to the floor or to the wall. If the cabinets are stacked they must be secured to the wall and their load capacity must be divided by 2. Further information for fixing set see page A130.

■ 01 ■ 02 ■ 04 ■ 08

FULL TELESCOPIC EXTENSION DRAWERS (TT)

ORD. NO.	FRONT HEIGHT mm	LOAD CAPACITY kg	USABLE DIMENSIONS mm
F FG 7107 00 04	75	150	1314x600x54 h
F FG 7110 00 04	100	150	1314x600x79 h
F FG 7112 00 04	125	150	1314x600x104 h
F FG 7115 00 04	150	150	1314x600x129 h
F FG 7117 00 04	175	150	1314x600x154 h
F FG 7120 00 04	200	150	1314x600x179 h
F FG 7125 00 04	250	150	1314x600x229 h
F FG 7130 00 04	300	150	1314x600x279 h

Full telescopic extension (100%)



■ Partitioning material: see page A137

■ 01
■ 02
■ 04
■ 08

FULL TELESCOPIC EXTENSION SHELVES (PE-TT)

ORD. NO.	SIDE HEIGHT mm	LOAD CAPACITY kg	USABLE DIMENSIONS mm
F FG 8170 00 04	–	150	1324x610

Full telescopic extension (100%)

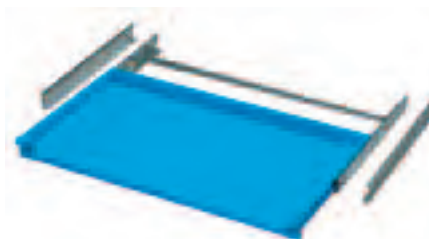

■ 01
■ 02
■ 04
■ 08

ADJUSTABLE SHELVES

ORD. NO.	SIDE HEIGHT mm	LOAD CAPACITY kg	USABLE DIMENSIONS mm
F SR 1290 01 04	35	150	1375x618

Without extension system



■ 01
■ 02
■ 04
■ 08



TWO SIDED ADHESIVE TAPE

ORD. NO.

R CMV 0025 00

width 15 mm, length 50 metres



■ 07

TOP SHELF

ORD. NO.

DIMENSIONS mm

F AG 9018 01 07

1434x726x20 h

oil-resistant rubber cover top with 3 edges

CABINET TO CABINET FIXING

■ The article includes:
4 M8 nuts and bolts

ORD. NO. F AG 9202 00 99

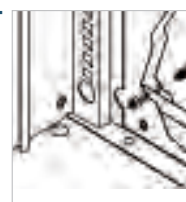

■ 07

PLINTHS

ORD. NO.

F RR 0115 00 07

Plinths height 50 mm



■ 07

PLINTHS FOR TRANSPALLET

ORD. NO.

F RR 0235 00 07 Plinths height 100 mm

F RR 0445 00 07 Facing piece

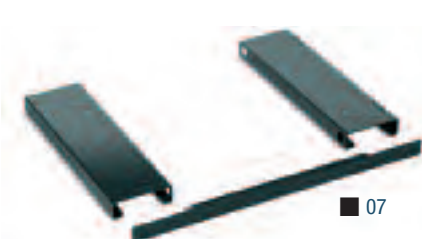

■ 07

PLINTHS FOR FORK LIFT TRUCK

ORD. NO.

F RR 0230 00 07 Pair of plinths height 60 mm

F RR 0440 00 07 Facing piece

LENGTH = 1431 mm DEPTH = 726 mm (78x36 Eh)

CABINETS SERIES STANDARD GD

UPPER MDF TOP WITH RUBBER COVERING DIMENSIONS 1434x726x31,5 mm H

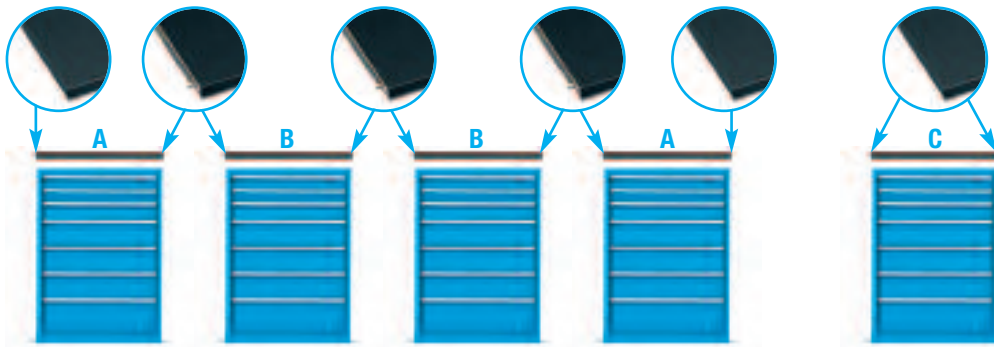

ORD. NO. F UZ 9998 00 00

Drilling of the cabinet upper shelf for the MDF top fixing.



Detail of the oil-resistant rubber

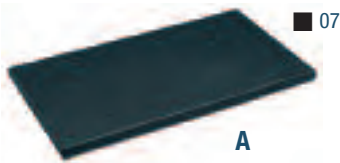

A



B

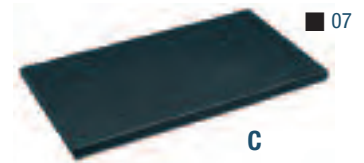

C

ORD. NO.

F UZ 3260 11 07

MDF top with rubber covering

Side profile

For end cabinets

Oil-resistant rubber mat

ORD. NO.

F UZ 3260 12 07

MDF top with rubber covering

No side profile

For additional central cabinets Oil-resist. rubber mat

ORD. NO.

F UZ 3260 13 07

MDF top with rubber covering

2 side profiles

For single cabinet

Oil-resistant rubber mat

CABINETS PREPARED FOR WHEELS

Cabinets prepared for wheels including: wheel plate, 4 edged top with oil-resistant rubber, 2 steel handles covered with shock-resistant rubber, cylinder lock with 2 keys, anti-tilt rod.

- 01
- 02
- 04
- 08



ORD. NO.

F AG 0734 00 04

Overall dim. mm:

1506x727x917 h without wheels

*Wheel plate thickness

- 01
- 02
- 04
- 08



ORD. NO.

F AG 0740 00 04

Overall dim. mm:

1506x727x1067 h without wheels

*Wheel plate thickness



The single drawer opening system ORD. NO. F DD 9400 00 07 must be applied to all drawers of mobile cabinets.

Other types of wheels see page A52



ELASTIC RUBBER SWIVEL WHEEL WITH BRAKE

ORD. NO.

C RG DCE15 160 160 600 kg 204



ELASTIC RUBBER FIXED WHEEL

ORD. NO.

C RG BCE15 160 160 600 kg 204



NYLON SWIVEL WHEEL WITH BRAKE

ORD. NO.

C RN DAD04 160 160 600 kg 204



NYLON FIXED WHEEL

ORD. NO.

C RN BAD04 160 160 600 kg 204

KEY

- RAL 7000 F.01
- RAL 6011 F.02
- RAL 5012 F.04
- RAL 7035 F.08



All indicated loads are net and refer to evenly distributed weights



The handles can be fitted towards the bottom thereby reducing the height by 38 mm.

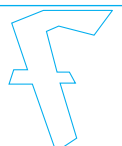

CABINETS SERIES STANDARD GD

**EXAMPLE INCLUDING:****ORD. NO.****F AG ZA03 00 56**

3 cabinets with drawers

Dimensions mm 1431x726x1850 h

Tools and partitioning material excluded

■ RAL 7035 + ■ RAL 7000

RAL 7000 F.01

RAL 6011 F.02

RAL 5012 F.04

RAL 7035 F.08

INFO ■

■ Partitioning material: see page **A180**

www.famispa.com



LENGTH = 1431 mm DEPTH = 726 mm (78x36 Eh)

CABINETS SERIES STANDARD GD

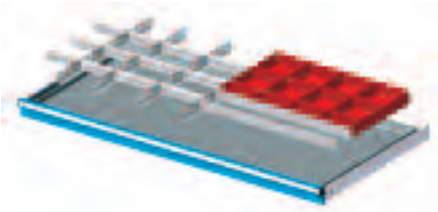

ORD. NO.	FOR FRONT HEIGHTS
----------	-------------------

F FH 7007 01 00	75
F FH 7010 01 00	100-125

Set including:

4 Slotted partitions	610 mm
2 Plain partitions	610 mm
6 Plain partitions	149 mm
6 Plain partitions	200 mm
4 Plastic boxes	150x75 mm
8 Plastic boxes	150x150 mm



ORD. NO.	FOR FRONT HEIGHTS
----------	-------------------

F FH 7007 02 00	75
F FH 7010 02 00	100-125
F FH 7015 02 00	150-175
F FH 7020 02 00	200-250

Set including:

5 Slotted partitions	610 mm
6 Plain partitions	149 mm
9 Plain partitions	251 mm

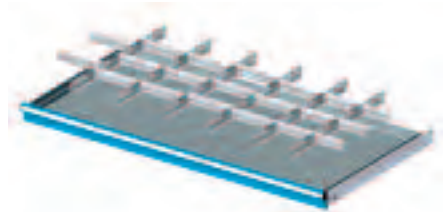

ORD. NO.	FOR FRONT HEIGHTS
----------	-------------------

F FH 7007 03 00	75
F FH 7010 03 00	100-125
F FH 7015 03 00	150-175

Set including:

6 Slotted partitions	610 mm
3 Plain partitions	132 mm
3 Plain partitions	166 mm
14 Plain partitions	200 mm

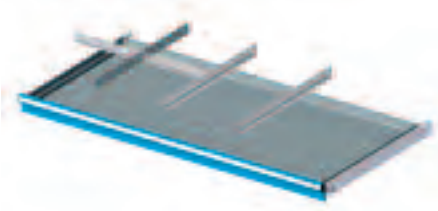

ORD. NO.	FOR FRONT HEIGHTS
----------	-------------------

F FH 7007 04 00	75
F FH 7010 04 00	100-125
F FH 7015 04 00	150-175
F FH 7020 04 00	200-250
F FH 7030 04 00	300

Set including:

3 Slotted partitions	610 mm
2 Plain partitions	302 mm

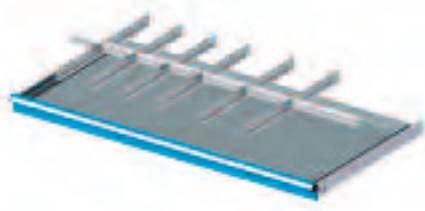

ORD. NO.	FOR FRONT HEIGHTS
----------	-------------------

F FH 7007 07 00	75
F FH 7010 07 00	100-125
F FH 7015 07 00	150-175
F FH 7020 07 00	200-250
F FH 7030 07 00	300

Set including:

6 Slotted partitions	610 mm
4 Plain partitions	149 mm
2 Plain partitions	200 mm
1 Plain partition	302 mm

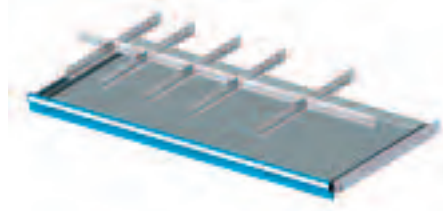

ORD. NO.	FOR FRONT HEIGHTS
----------	-------------------

F FH 7007 08 00	75
F FH 7010 08 00	100-125
F FH 7015 08 00	150-175
F FH 7020 08 00	200-250
F FH 7030 08 00	300

Set including:

5 Slotted partitions	610 mm
2 Plain partitions	149 mm
2 Plain partitions	200 mm
2 Plain partitions	302 mm



■ INFO



www.famispa.com

■ Partitioning material: see page A180

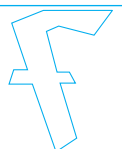

CABINETS SERIES STANDARD FG-FI



ORD. NO. F AF 2040 S1 56
RAL 7035+7000

CABINET**ORD. NO.****F AF 2040 S1 56**

Complete with 1 pair of sliding doors

1 height adjustable shelf

1 rubber cover MDF top

Dimensions mm 1431x726x1030 h

Tools, boxes and toolboxes excluded

LOAD CAPACITY: 200 kg

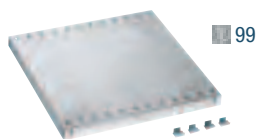

LOAD CAPACITY: 150 kg



RAL 7000 F.01

RAL 6011 F.02

RAL 5012 F.04

RAL 7035 F.08

SUPPLEMENTARY PARTS ■

■ All indicated loads are net and refer to evenly distributed weights



■ **Spare key.** Always indicate the number on the cylinder lock of the key to be replaced.

ORD. NO. R CSC 0002 00

■ **Master key.** This type of key opens all the 45 and 46 series locks.

ORD. NO. R CSC 0001 00



LENGTH = 1431 mm DEPTH = 726 mm

CABINETS SERIES STANDARD FG-FI



ORD. NO.	SHELVES
F AE 5040 13 04	1
Cabinet with 1 shelf depth 623 mm	
Dimensions mm 1431x726x1000 h	



ORD. NO.	SHELVES
F AE 5040 14 04	2
Cabinet with 2 shelves depth 623 mm, 1 centre support	
Dimensions mm 1431x726x1000 h	



ORD. NO.	SHELVES
F AF 2040 13 04	1
Cabinet with 1 shelf depth 623 mm	
Dimensions mm 1431x726x1000 h	



ORD. NO.	SHELVES
F AF 2040 14 04	2
Cabinet with 2 shelves depth 623 mm, 1 centre support	
Dimensions mm 1431x726x1000 h	



ORD. NO.	SHELVES
F AE 5053 13 04	1
Cabinet with 1 shelf depth 623 mm	
Dimensions mm 1431x726x1325 h	



ORD. NO.	SHELVES
F AE 5053 14 04	2
Cabinet with 2 shelves depth 623 mm, 1 centre support	
Dimensions mm 1431x726x1325 h	

■ INFO



www.famispa.com

RAL 7000 F.01 RAL 6011 F.02 RAL 5012 F.04 RAL 7035 F.08

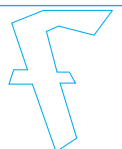

CABINETS SERIES STANDARD FG-FI



ORD. NO.

SHELVES

F AF 2053 13 04**1**

Cabinet with 1 shelf depth 623 mm

Dimensions mm 1431x726x1325 h



ORD. NO.

SHELVES

F AF 2053 14 04**2**

Cabinet with 2 shelves depth 623 mm, 1 centre support

Dimensions mm 1431x726x1325 h



ORD. NO.

SHELVES

F AE 5058 13 04**1**

Cabinet with 1 shelf depth 623 mm

Dimensions mm 1431x726x1450 h



ORD. NO.

SHELVES

F AE 5058 14 04**2**

Cabinet with 2 shelves depth 623 mm, 1 centre support

Dimensions mm 1431x726x1450 h

RAL 7000 F.01 RAL 6011 F.02 RAL 5012 F.04 RAL 7035 F.08

INFO ■

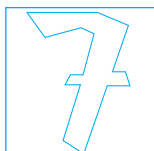
www.famispa.com

LENGTH = 1431 mm DEPTH = 726 mm

CABINETS SERIES STANDARD FG-FI



ORD. NO.	SHELVES
F AF 2058 13 04	1
Cabinet with 1 shelf depth 623 mm	
Dimensions mm 1431x726x1450 h	

ORD. NO.	SHELVES
F AF 2058 14 04	2
Cabinet with 2 shelves depth 623 mm, 1 centre support	
Dimensions mm 1431x726x1450 h	

EXAMPLE INCLUDING:

ORD. NO.
F AG ZA04 00 56
1 corner cabinet
3 cabinets with drawers
1 cabinet with sliding doors and adjustable shelf
1 cabinet with adjustable shelf without sliding doors
3 rubber cover MDF tops
Tools, partitioning material and boxes excluded

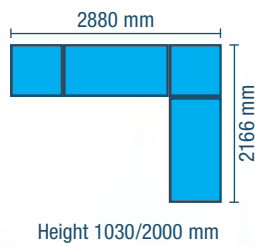

■ RAL 7035 +
■ RAL 7000

■ INFO

■ RAL 7000 F.01 ■ RAL 6011 F.02 ■ RAL 5012 F.04 ■ RAL 7035 F.08



www.famispa.com



CABINETS SERIES STANDARD FG-FI

CABINET TO CABINET FIXING

■ The article includes:
4 M8 nuts and bolts

ORD. NO. F AG 9202 00 99

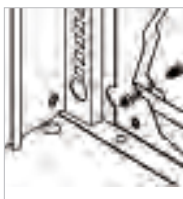

TWO SIDED ADHESIVE TAPE

ORD. NO.

R CMV 0025 00

width 15 mm, length 50 metres



■ 07

PLINTHS

ORD. NO.

F RR 0115 00 07

Plinths height 50 mm



■ 07

PLINTHS FOR TRANSPALLET

ORD. NO.

F RR 0235 00 07 Plinths height 100 mm

F RR 0445 00 07 Facing piece



■ 07

PLINTHS FOR FORK LIFT TRUCK

ORD. NO.

F RR 0230 00 07 Pair of plinths height 60 mm

F RR 0440 00 07 Facing piece

GALVANISED ADJUSTABLE SHELVES

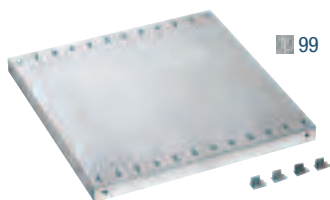

■ 99

■ This type of shelf can only be used when there is a centre support.

ORD. NO.

F AF 9109 03 99

Load capacity: 200 kg

Dimensions mm 683x623x35 h

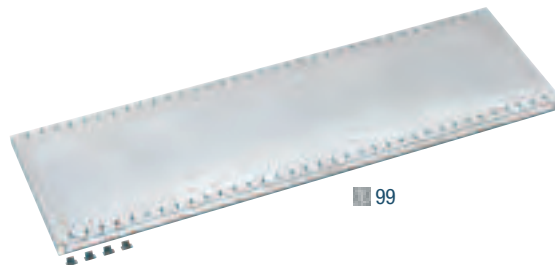

■ 99

ORD. NO.

F AF 9139 05 99

Load capacity: 150 kg

Dimensions mm 1395x623x35 h

adjustable shelf

ORD. NO. F AF 9109 03 99



centre support

adjustable shelf

ORD. NO. F AF 9139 05 99

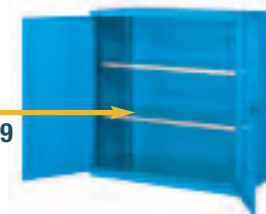

CONTAINERS

■ see page G28-G30



size 4



size 4A2



size 4A5

RAL 7000 F.01

RAL 6011 F.02

RAL 5012 F.04

RAL 7035 F.08

KEY ■

■ All indicated loads are net and refer to evenly distributed weights

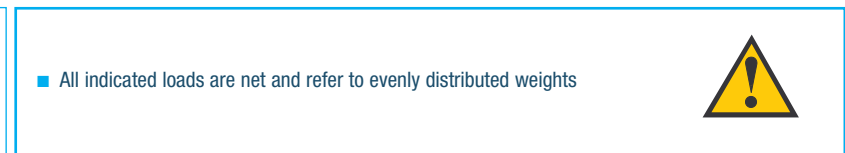
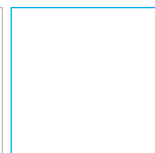
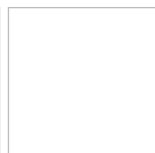
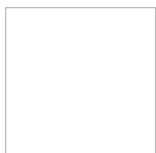
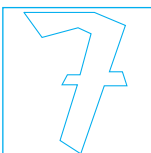

LENGTH = 1431 mm DEPTH = 726 mm

CABINETS SERIES STANDARD FG-FI



■ 99

SHELF DIVIDERS

ORD. NO.

F AF 9400 00 99

shelf divider



■ 99

SIDE PANEL

ORD. NO.

F AF 9420 00 99

Shelves side panel



■ 07

TOP SHELF

ORD. NO.

DIMENSIONS mm

F AG 9018 01 07

1431x726x20 h

oil-resistant rubber cover top with 3 edges

SPARE LOCKS FOR CABINETS SERIES F AE

ORD. NO.

R CSR 0008 00

Spare locks for cabinets ORD. NO. F AE 5040 - 5053 - 5058

R XAE 0006 99

Spare rods for cabinets ORD. NO. F AE 5058

R XAE 0004 99

Spare rods for cabinets ORD. NO. F AE 5040

R XAE 0005 99

Spare rods for cabinets ORD. NO. F AE 5053

SPARE LOCKS FOR CABINETS SERIES F AF

ORD. NO.

R CSR 0012 00

Spare lock

■ Spare key see page A138

UPPER MDF TOP WITH RUBBER COVERING DIMENSIONS 1434x726x31,5 mm H

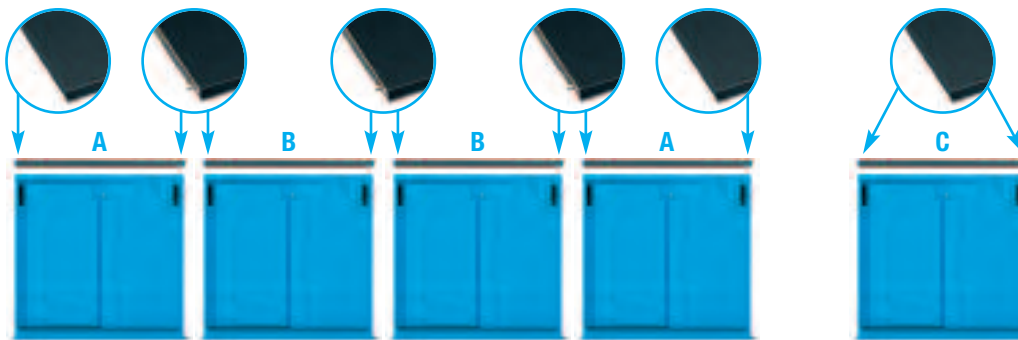

ORD. NO. F UZ 9998 00 00

Drilling of the cabinet upper shelf for the MDF top fixing.



Detail of the oil-resistant rubber

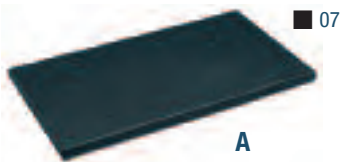

A

ORD. NO.

F UZ 3260 11 07

MDF top with rubber covering

Side profile

For end cabinets

Oil-resistant rubber mat



B

ORD. NO.

F UZ 3260 12 07

MDF top with rubber covering

No side profile

For additional central cabinets

Oil-resist. rubber mat

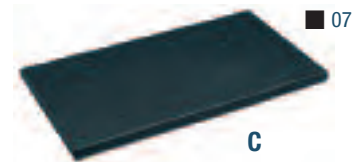

C

ORD. NO.

F UZ 3260 13 07

MDF top with rubber covering

2 side profiles

For single cabinet

Oil-resistant rubber mat

■ INFO

RAL 7000 F.01

RAL 6011 F.02

RAL 5012 F.04

RAL 7035 F.08



www.famispa.com



CORNER CABINETS SERIES
STANDARD FL-G

DEPTH = 726 mm (36 Eh)

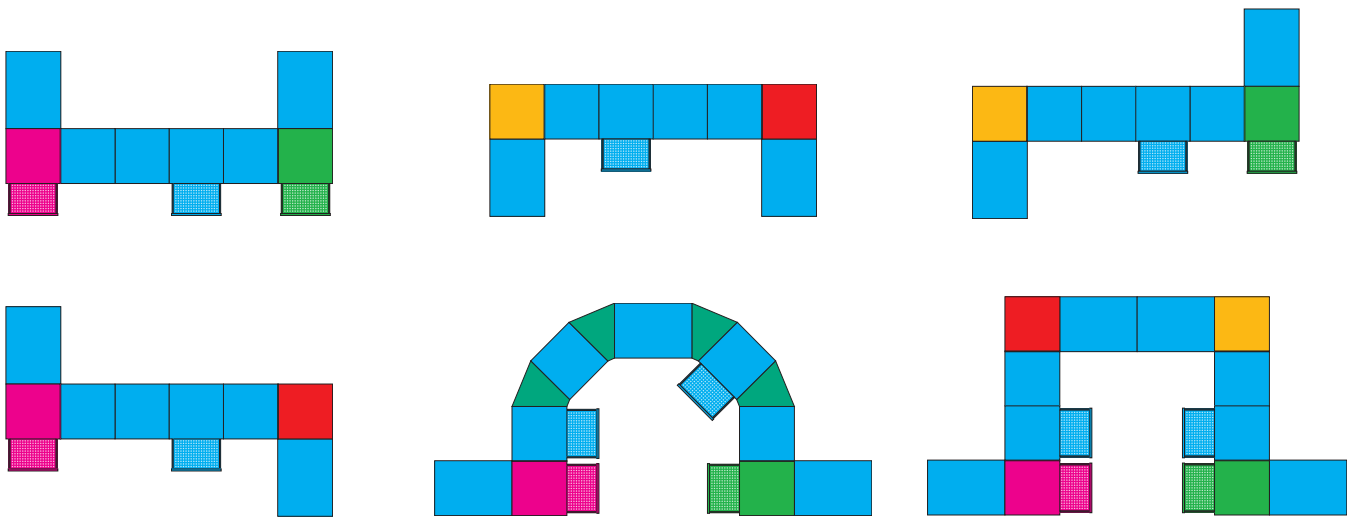

RAL 7000 F.01 RAL 6011 F.02 RAL 5012 F.04 RAL 7035 F.08

SUPPLEMENTARY PARTS ■

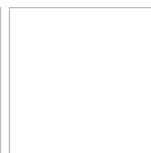
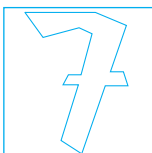

- **Spare key.** Always indicate the number on the cylinder lock of the key to be replaced.
ORD. NO. R CSC 0002 00
- **Master key.** This type of key opens all the 45 and 46 series locks.
ORD. NO. R CSC 0001 00



DEPTH = 726 mm (36 Eh)

CORNER CABINETS SERIES
STANDARD FL-GWOODEN COVERS: PLEASE, CONTACT **FAMI** FOR DETAILED INFORMATION.

ORD. NO.

F AG 0050 00 04

45° angle

Dimensions mm 653x671x1000 h

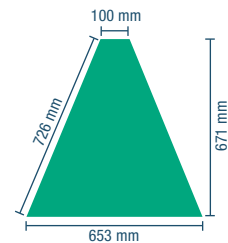
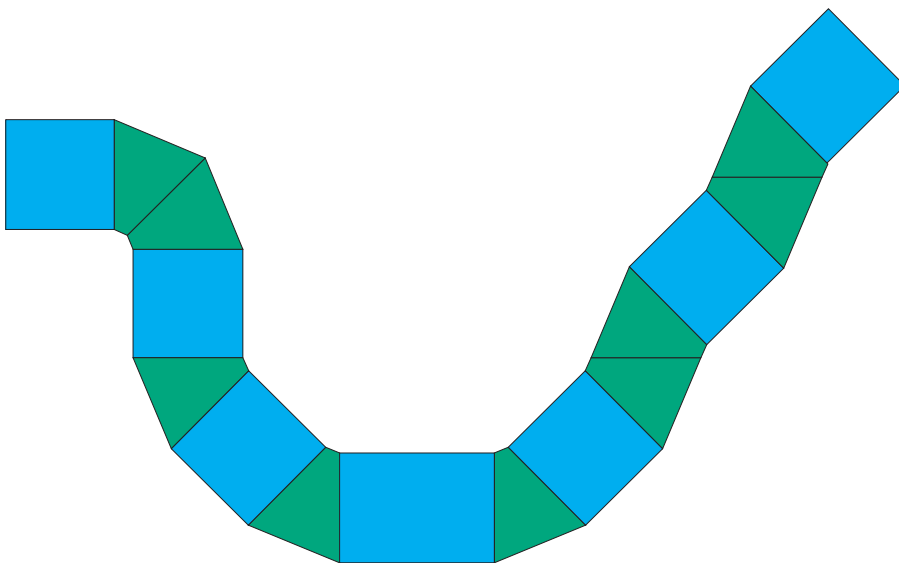

■ This corner cabinet can stick with 726 mm (36 Eh) depth STANDARD series cabinets only.

■ INFO

RAL 7000 F.01

RAL 6011 F.02

RAL 5012 F.04

RAL 7035 F.08

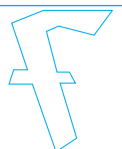

www.famispaspa.com

CORNER CABINETS SERIES
STANDARD FL-G

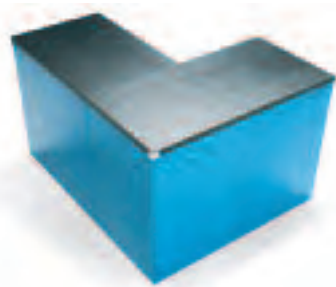
DEPTH = 726 mm (36 Eh)

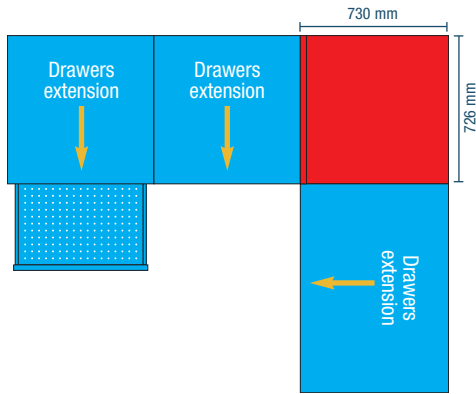

Back view



■ This corner cabinets can stick with 726 mm (36 Eh) depth STANDARD series cabinets only.



ORD. NO.

F AG 2040 R1 04
Right side external corner cabinet
Dimensions mm 730x726x1000 h



ORD. NO.

F AG 2040 R2 04
Right side external corner cabinet
with MDF top and oil-resistant rubber cover
Dimensions mm 730x726x1030 h



ORD. NO.

F AG 2040 L1 04
Left side external corner cabinet
Dimensions mm 730x726x1000 h



ORD. NO.

F AG 2040 L2 04
Left side external corner cabinet
with MDF top and oil-resistant rubber cover
Dimensions mm 730x726x1030 h

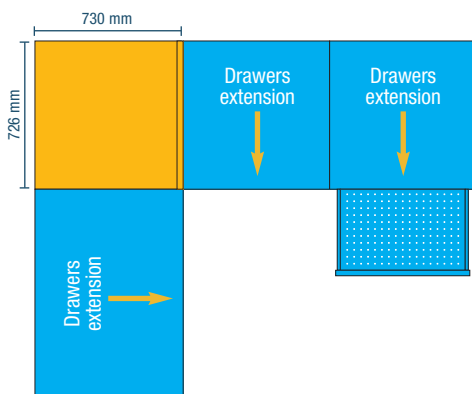

RAL 7000 F.01 RAL 6011 F.02 RAL 5012 F.04 RAL 7035 F.08

KEY ■

■ The cabinets must be secured to the floor or to the wall

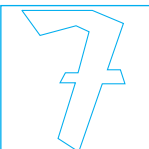

DEPTH = 726 mm (36 Eh)

CORNER CABINETS SERIES STANDARD FL-G

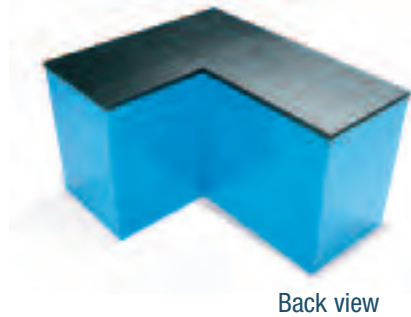

Back view



ORD. NO.

F AG 2040 L3 04

Left side internal corner cabinet
Dimensions mm 730x726x1000 h



ORD. NO.

F AG 2040 L4 04

Left side internal corner cabinet
with MDF top and oil-resistant rubber cover
Dimensions mm 730x726x1030 h

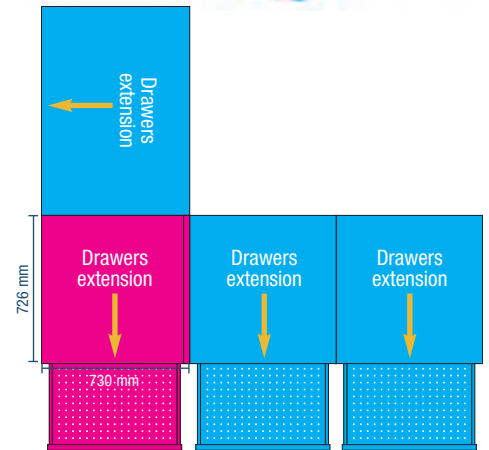

■ This corner cabinets can stick with 726 mm (36 Eh) depth STANDARD series cabinets only.

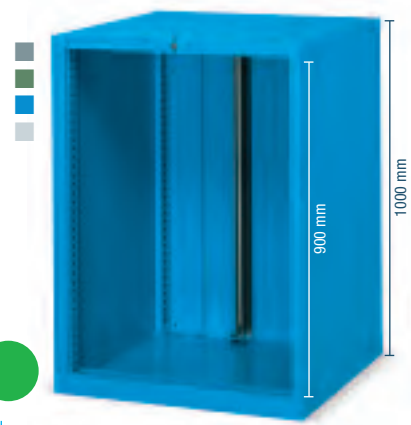

ORD. NO.

F AG 2040 R3 04

Right side internal corner cabinet
Dimensions mm 730x726x1000 h



ORD. NO.

F AG 2040 R4 04

Right side internal corner cabinet
with MDF top and oil-resistant rubber cover
Dimensions mm 730x726x1030 h

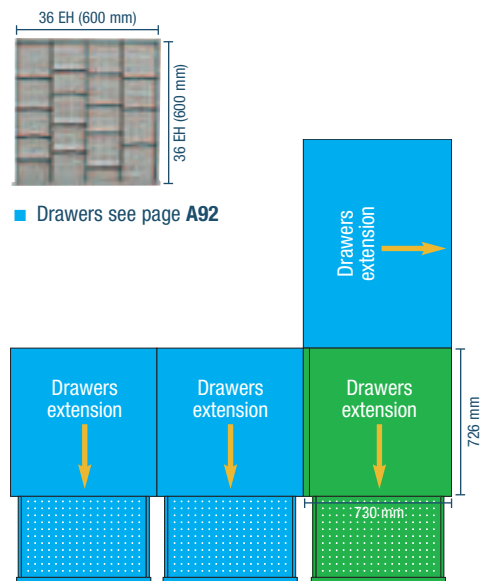

■ Drawers see page A92

KEY

- RAL 7000 F.01
- RAL 6011 F.02
- RAL 5012 F.04
- RAL 7035 F.08



■ The cabinets must be secured to the floor or to the wall

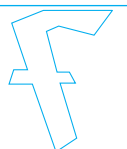

CORNER CABINETS SERIES
STANDARD F DA

DEPTH = 554 mm (27 Eh)

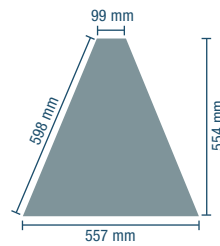
**ORD. NO.****F DA 0050 00 01**

45° angle

Dimensions mm 557x554x1000 h

■ This corner cabinet can stick with 600 mm (27 Eh) depth FLEXA series cabinets only or with cabinets of the PERFORM A800, A600 and A400 series.

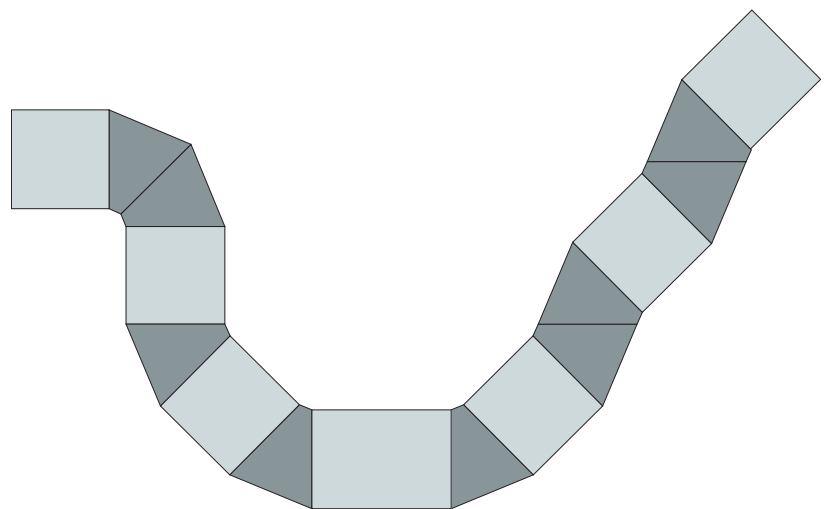

RAL 7000 F.01

RAL 6011 F.02

RAL 5012 F.04

RAL 7035 F.08

INFO ■
www.famispa.com

DEPTH = 554 mm (27 Eh)

CORNER CABINETS SERIES
STANDARD F DA**ORD. NO.****F BS 9140 00 00**

Top cover with laminate with 2 rounded edges for FLEXA F DL/F DM cabinets and PERFORM cabinets series F AB 4100

Dimensions mm 1024x650x30 h

**ORD. NO.****F BS 9130 00 00**

Top cover with laminate with 2 rounded edges for cabinets series F DG/F DF

Dimensions mm 718x650x30 h

**ORD. NO.****F BS 9110 00 00**

Top cover with laminate only for use with corner cabinet ORD. NO. F DA 0050 00 ..

Dimensions mm 577x601x30 h



■ INFO



www.famispa.com

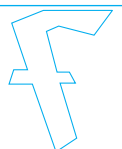

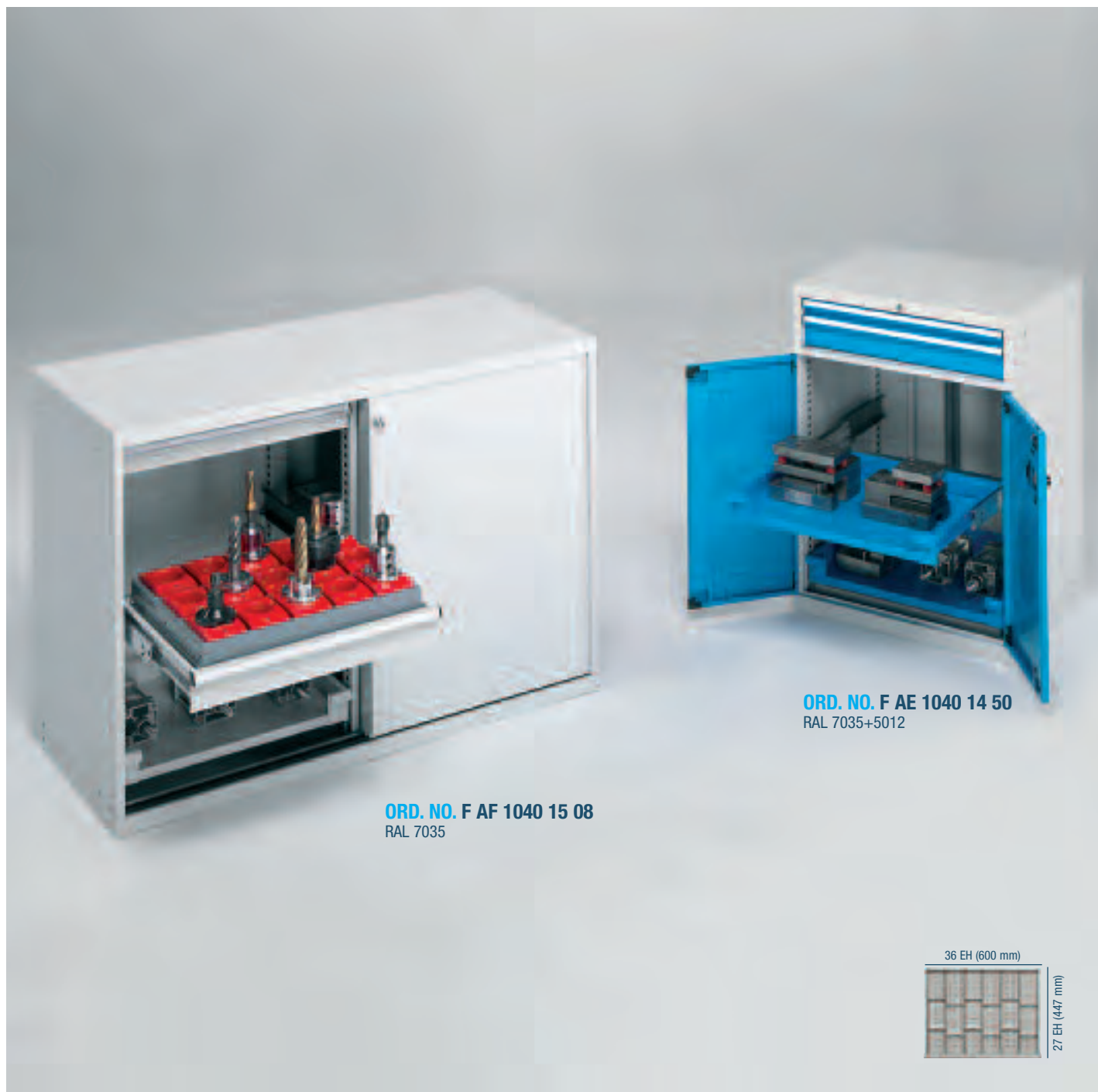

ORD. NO. F AF 1040 15 08
RAL 7035

ORD. NO. F AE 1040 14 50
RAL 7035+5012

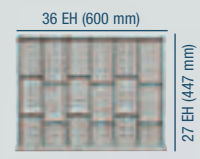

FLOOR FIXING SET



- 2 "HILTI" plugs for concrete floors \geq to classes B25/RBK250/MPa 25 N/mm²
- Recommended traction of the plug: 2.9 KN
- Plug diameter: \varnothing 6 mm

ORD. NO. F AG 9204 00 99

CABINET FLOOR FIXING SET

- Pair of spare galvanised brackets
- \varnothing 6 mm hole



ORD. NO. F AG 9200 00 99

CABINET WITH SLIDING DOORS

ORD. NO.

F AF 1040 15 08

- Complete with 4 drawers
- 2 retract. shelves, 2 tool holder frames
- Dimensions mm 1431x632x1000 h**
- Tools and tool holders excluded

CABINET WITH LEAF DOORS

ORD. NO.

F AE 1040 14 50

- Complete with 2 drawers, 2 retractable shelves
- Dimensions mm 717x597x1000 h**
- Tools excluded

RAL 7000 F.01 RAL 6011 F.02 RAL 5012 F.04 RAL 7035 F.08

SUPPLEMENTARY PARTS ■

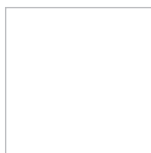
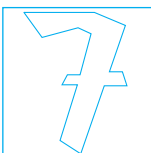

- **Spare key.** Always indicate the number on the cylinder lock of the key to be replaced.
ORD. NO. R CSC 0002 00
- **Master key.** This type of key opens all the 45 and 46 series locks.
ORD. NO. R CSC 0001 00



LENGTH = 717 mm DEPTH = 597/632 mm (36x27 Eh)

CABINETS SERIES STANDARD F27

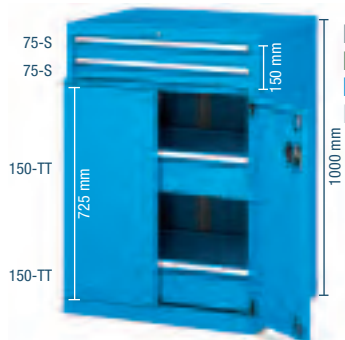

ORD. NO.	DRAWERS
F AE 1040 01 04	4
Cabinet with 4 drawers	
Dimensions mm 717x597x1000 h	
Central lock	



ORD. NO.	DRAWERS
F AE 1040 10 04	3
Cabinet with 3 drawers	
2 retractable shelves	
Dim. mm 717x597x1000 h	
Central lock	



ORD. NO.	DRAWERS
F AE 1040 11 04	5
Cabinet with 5 drawers	
1 retractable shelf	
Dim. mm 717x597x1000 h	
Central lock	

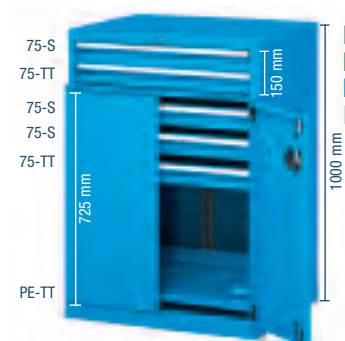

ORD. NO.	DRAWERS
F AE 1040 12 04	5
Cabinet with 5 drawers	
1 retractable shelf	
Dim. mm 717x597x1000 h	
Central lock	



ORD. NO.	DRAWERS
F AE 1040 13 04	4
Cabinet with 4 drawers	
Dimensions mm 717x597x1000 h	
Central lock	



ORD. NO.	DRAWERS
F AE 1040 14 04	2
Cabinet with 2 drawers	
2 retractable shelves	
Dim. mm 717x597x1000 h	
Central lock	

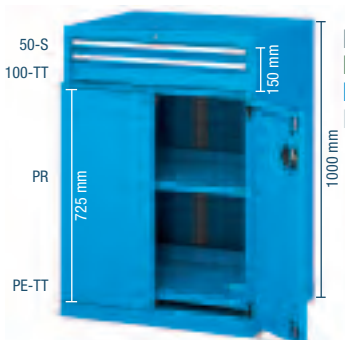

ORD. NO.	DRAWERS
F AE 1040 15 04	2
Cabinet with 2 drawers	
1 retractable shelf, 1 adjustable shelf	
Dim. mm 717x597x1000 h	
Central lock	

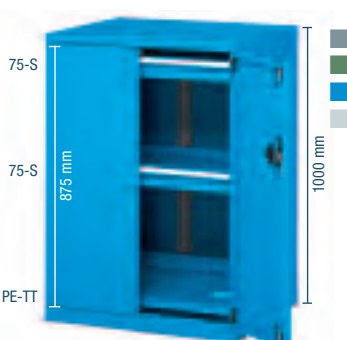

ORD. NO.	DRAWERS
F AE 2040 01 04	2
Cabinet with 2 drawers	
1 retractable shelf	
Dimensions mm 717x597x1000 h	

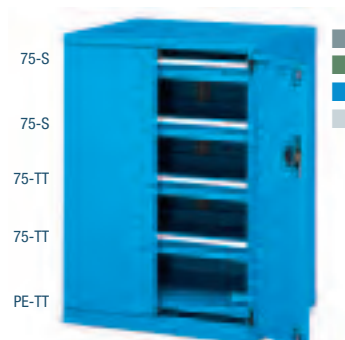

ORD. NO.	DRAWERS
F AE 2040 03 04	4
Cabinet with 4 drawers	
1 retractable shelf	
Dimensions mm 717x597x1000 h	

KEY

- RAL 7000 F.01
- RAL 6011 F.02
- RAL 5012 F.04
- RAL 7035 F.08



- TT = telescopic full extension (100%)
- PE-TT = full telescopic retractable shelf (100%)
- S = normal extension (87%)
- PR = height adjustable shelf

The cabinets must be secured to the floor or to the wall



CABINETS SERIES STANDARD F27

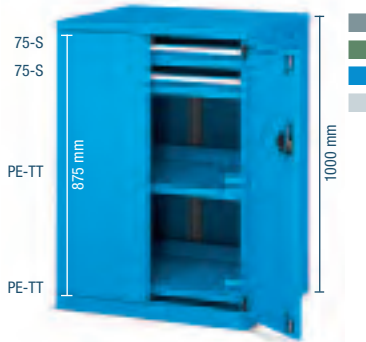

ORD. NO.	DRAWERS
F AE 2040 05 04	2
Cabinet with 2 drawers	
2 retractable shelves	
Dimensions mm 717x597x1000 h	

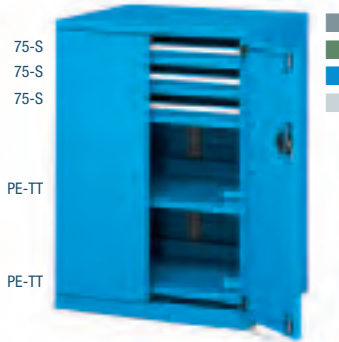

ORD. NO.	DRAWERS
F AE 2040 06 04	3
Cabinet with 3 drawers	
2 retractable shelves	
Dimensions mm 717x597x1000 h	

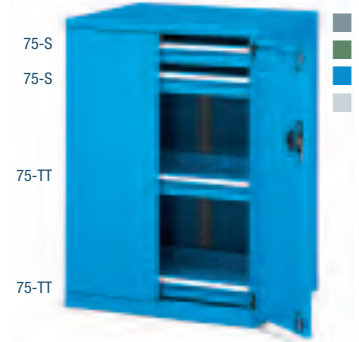

ORD. NO.	DRAWERS
F AE 2040 07 04	4
Cabinet with 4 drawers	
Dimensions mm 717x597x1000 h	

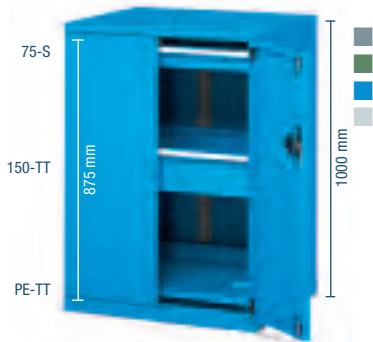

ORD. NO.	DRAWERS
F AE 2040 10 04	2
Cabinet with 2 drawers	
1 retractable shelf	
Dimensions mm 717x597x1000 h	



ORD. NO.	DRAWERS
F AE 2040 04 04	1
Cabinet with 1 drawers	
2 retractable shelves	
Dimensions mm 717x597x1000 h	



ORD. NO.	DRAWERS
F AE 2040 11 04	3
Cabinet with 3 drawers	
1 retractable shelf	
Dimensions mm 717x597x1000 h	

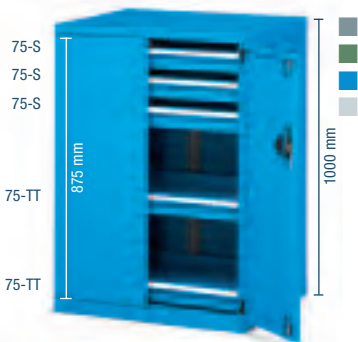

ORD. NO.	DRAWERS
F AE 2040 12 04	5
Cabinet with 5 drawers	
Dimensions mm 717x597x1000 h	



ORD. NO.	SHELVES
F AE 2040 13 04	2
Cabinet with 2 retract. shelves, 1 adjustable shelf	
Dimensions mm 717x597x1000 h	

RAL 7000 F.01 RAL 6011 F.02 RAL 5012 F.04 RAL 7035 F.08

KEY ■

■ The cabinets must be secured to the floor or to the wall

- TT = telescopic full extension (100%)
- PE-TT = full telescopic retractable shelf (100%)
- S = normal extension (87%)
- PE-S = normal retractable shelf (87%)
- PR = height adjustable shelf



LENGTH = 717 mm DEPTH = 597/632 mm (36x27 Eh)

CABINETS SERIES STANDARD F27



RAL 7035

CABINET WITH SLIDING DOORS**ORD. NO.****F AF 1040 S1 08**

complete with 4 drawers, 2 retractable shelves,
2 tool holder frames,
1 rubber cover top with 3 edges

Dimensions mm 1431x632x1020 h

Tools and tool holders excluded



RAL 7000

CABINET WITH LEAF DOORS**ORD. NO.****F AE 2040 S1 01**

complete with 4 drawers, 2 tool holder frames,
1 rubber cover top with 3 edges

Dimensions mm 717x597x1020 h

Tools, tool holders and partitioning material excluded

KEY

RAL 7000 F.01

RAL 6011 F.02

RAL 5012 F.04

RAL 7035 F.08



- The cabinets must be secured to the floor or to the wall

■ Partitioning material: see page **A180**

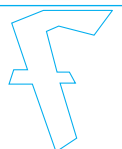

CABINETS SERIES STANDARD F27



ORD. NO.	DRAWERS
F AF 1040 06 04	2
Cabinet with 2 drawers, 6 retractable shelves	
Dimensions mm 1431x632x1000 h	



ORD. NO.	DRAWERS
F AF 1040 01 04	4
Cabinet with 4 drawers, 2 retractable shelves	
Dimensions mm 1431x632x1000 h	



ORD. NO.	DRAWERS
F AF 1040 02 04	6
Cabinet with 6 drawers, 2 retractable shelves	
Dimensions mm 1431x632x1000 h	



ORD. NO.	DRAWERS
F AF 1040 04 04	4
Cabinet with 4 drawers, 4 retractable shelves	
Dimensions mm 1431x632x1000 h	



ORD. NO.	DRAWERS
F AF 1040 13 04	8
Cabinet with 8 drawers, 2 retractable shelves	
Dimensions mm 1431x632x1000 h	



ORD. NO.	DRAWERS
F AF 1040 09 04	10
Cabinet with 10 drawers	
Dimensions mm 1431x632x1000 h	

RAL 7000 F.01 RAL 6011 F.02 RAL 5012 F.04 RAL 7035 F.08

KEY ■

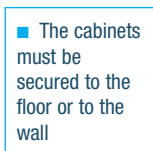
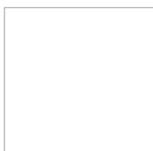
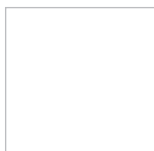
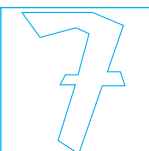

■ The cabinets must be secured to the floor or to the wall

- TT = telescopic full extension (100%)
- PE-TT = full telescopic retractable shelf (100%)
- S = normal extension (87%)



LENGTH = 717 mm DEPTH = 597/632 mm (36x27 Eh)

CABINETS SERIES STANDARD F27



ORD. NO.	DRAWERS
F AF 1040 10 04	4
Cabinet with 4 drawers, 2 retractable shelves	
Dimensions mm 1431x632x1000 h	



ORD. NO.	SHELVES
F AF 1040 14 04	6
Cabinet with 4 retractable shelves, 2 adjustable shelves	
Dimensions mm 1431x632x1000 h	



KEY



- TT = telescopic full extension (100%)
- PE-TT = full telescopic retractable shelf (100%)
- S = normal extension (87%)
- PR = height adjustable shelf

RAL 7000 F.01 RAL 6011 F.02 RAL 5012 F.04 RAL 7035 F.08

■ The cabinets must be secured to the floor or to the wall

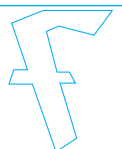

CABINETS SERIES STANDARD F27

EMPTY CABINET (FB102)



■ 01
■ 02
■ 04
■ 08

ORD. NO. LOAD CAPACITY kg

F AE 1040 00 04 3000

Dimensions mm 717x597x1000 h

Usable height mm 150+725

Cabinet including 2 cylinder locks and 4 keys

ORD. NO.

R CSR 0003 00

Spare lock (for cabinet)

R CSR 0008 00

Spare lock (for door)

R XAE 0001 99

Pair of spare rod (for door)

EMPTY CABINET (FB100)



■ 01
■ 02
■ 04
■ 08

ORD. NO. LOAD CAPACITY kg

F AE 2040 00 04 3000

Dimensions mm 717x597x1000 h

Usable height mm 875

Cabinet including cylinder lock and 2 keys

ORD. NO.

R CSR 0008 00

Spare lock (for door)

R XAE 0002 99

Pair of spare rod (for door)

EMPTY CABINET (FD100)



■ 01
■ 02
■ 04
■ 08

ORD. NO. LOAD CAPACITY kg

F AF 1040 00 04 1500+1500

Dimensions mm 1431x632x1000 h

Usable height mm 875

Cabinet including cylinder lock and 2 keys

ORD. NO.

R CSR 0012 00

Spare lock (for door)

■ Spare key see page A150

■ The cabinet must be secured to the floor or to the wall. Further information for fixing set see page A150.

NORMAL EXTENSION DRAWERS (S)

ORD. NO.	FRONT HEIGHT mm	LOAD CAPACITY kg	USABLE DIMENSIONS mm
F FG 1005 00 04	50	60	600x447x36 h
F FG 1007 00 04	75	80	600x447x61 h
F FG 1010 00 04	100	100	600x447x86 h
F FG 1012 00 04	125	100	600x447x111 h

Normale extension (87%)



■ 01
■ 02
■ 04
■ 08

■ Partitioning material: see page A80-A81

FULL TELESCOPIC EXTENSION DRAWERS (TT)

ORD. NO.	FRONT HEIGHT mm	LOAD CAPACITY kg	USABLE DIMENSIONS mm
F FG 1107 00 04	75	200	600x447x54 h
F FG 1110 00 04	100	200	600x447x79 h
F FG 1112 00 04	125	200	600x447x104 h
F FG 1115 00 04	150	200	600x447x129 h
F FG 1120 00 04	200	200	600x447x179 h
F FG 1125 00 04	250	200	600x447x229 h
F FG 1130 00 04	300	200	600x447x279 h

Full telescopic extension (100%)



■ 01
■ 02
■ 04
■ 08

■ Partitioning material: see page A80-A81

NORMAL EXTENSION SHELVES (PE-S)

ORD. NO.	SIDE HEIGHT mm	LOAD CAPACITY kg	USABLE DIMENSIONS mm
F FG 8010 00 04	–	100	610x459

Normale extension (87%)



■ 01
■ 02
■ 04
■ 08

FULL TELESCOPIC EXTENSION SHELVES (PE-TT)

ORD. NO.	SIDE HEIGHT mm	LOAD CAPACITY kg	USABLE DIMENSIONS mm
F FG 8110 00 04	–	200	610x459

Full telescopic extension (100%)



■ 01
■ 02
■ 04
■ 08

ADJUSTABLE SHELVES

ORD. NO.	SIDE HEIGHT mm	LOAD CAPACITY kg	USABLE DIMENSIONS mm
F SR 1210 01 04	25	150	655x460

Without extension system



■ 01
■ 02
■ 04
■ 08

LENGTH = 717 mm DEPTH = 597/632 mm (36x27 Eh)

CABINETS SERIES STANDARD F27

CABINET TO CABINET FIXING

■ The article includes:
4 M8 nuts and bolts.
Suitable for fixing same
series cabinets only.

ORD. NO. F AG 9202 00 99



TWO SIDED ADHESIVE TAPE

ORD. NO.

R CMV 0025 00

width 15 mm
length 50 metres



■ 07

PLINTHS

For cabinet F AE 1040 - F AE 2040

ORD. NO.

F RR 0060 00 07

Plinths height 50 mm

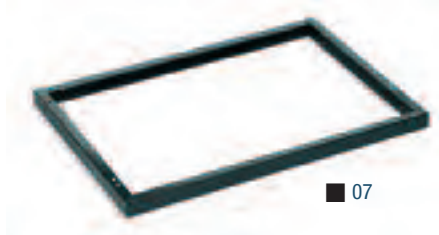

■ 07

PLINTHS

For cabinet F AF 1040

ORD. NO.

F RR 0110 00 07

Plinths height 50 mm

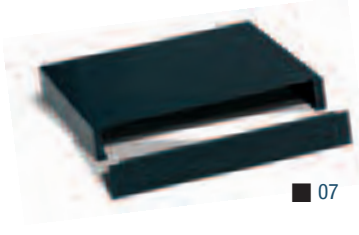

■ 07

PLINTHS FOR TRANSPALLET

For cabinet F AE 1040 - F AE 2040

ORD. NO.

F RR 0305 00 07 Plinths height 100 mm

F RR 0405 00 07 Facing piece



■ 07

PLINTHS FOR TRANSPALLET

For cabinet F AF 1040

ORD. NO.

F RR 0225 00 07

Pair of plinths height 100 mm

F RR 0445 00 07

Facing piece

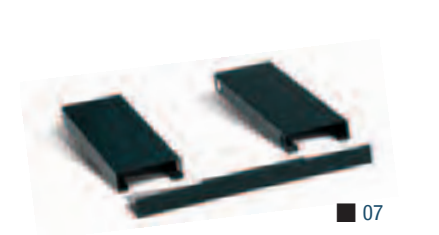

■ 07

PLINTHS FOR FORK LIFT TRUCK

For cabinet F AE 1040 - F AE 2040

ORD. NO.

F RR 0210 00 07

Pair of plinths height 60 mm

F RR 0400 00 07

Facing piece



■ 07

PLINTHS FOR FORK LIFT TRUCK

For cabinet F AF 1040

ORD. NO.

F RR 0220 00 07

Pair of plinths height 60 mm

F RR 0440 00 07

Facing piece

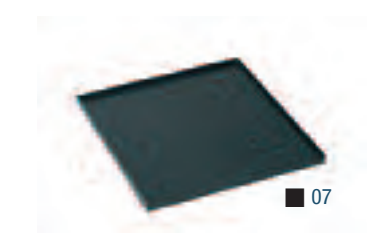

■ 07

TOP SHELF

For cabinet F AE 1040

ORD. NO.

DIMENSIONS mm

F AG 9000 01 07

717x573x20 h

oil-resistant rubber cover top with 3 edges

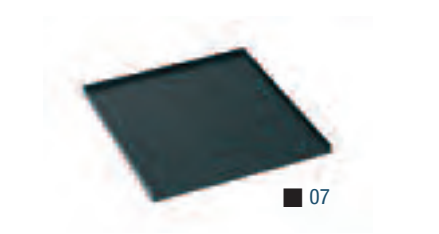

■ 07

TOP SHELF

For cabinet F AE 2040

ORD. NO.

DIMENSIONS mm

F AE 9003 01 07

717x597x20 h

oil-resistant rubber cover top with 3 edges



■ 07

TOP SHELF

For cabinet F AF 1040

ORD. NO.

DIMENSIONS mm

F AF 9000 01 07

1431x630x20 h

oil-resistant rubber cover top with 3 edges

■ INFO



www.famispa.com



CABINETS SERIES STANDARD F36



ORD. NO. F AE 4058 14 01
RAL 7000

ORD. NO. F AF 3040 17 08
RAL 7035

36 EH (600 mm)

36 EH (600 mm)

FLOOR FIXING SET



2x

- 2 "HILTI" plugs for concrete floors \geq to classes B25/RBK250/MPa 25 N/mm²
- Recommended traction of the plug: 2.9 KN
- Plug diameter: \varnothing 6 mm

ORD. NO. F AG 9204 00 99

CABINET FLOOR FIXING SET

- Pair of spare galvanised brackets
- \varnothing 6 mm hole



ORD. NO. F AG 9200 00 99

CABINET WITH SLIDING DOORS

ORD. NO.

F AF 3040 17 08

Complete with 4 drawers

2 retractable shelves

2 tool holder frames

Dimensions mm 1431x785x1000 h

Tools and tool holders excluded

CABINET WITH LEAF DOORS

ORD. NO.

F AE 4058 14 01

Complete with 3 drawers

2 retractable shelves

1 tool holder frame

Dimensions mm 717x750x1450 h

Tools and tool holders excluded

RAL 7000 F.01

RAL 6011 F.02

RAL 5012 F.04

RAL 7035 F.08

SUPPLEMENTARY PARTS ■

- **Spare key.** Always indicate the number on the cylinder lock of the key to be replaced.

ORD. NO. R CSC 0002 00

- **Master key.** This type of key opens all the 45 and 46 series locks.

ORD. NO. R CSC 0001 00

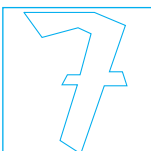

LENGTH = 717 mm DEPTH = 750/785 mm (36x36 Eh)

CABINETS SERIES STANDARD F36



ORD. NO.	DRAWERS
F AE 3040 01 04	4
Cabinet with 4 drawers	
Dimensions mm 717x750x1000 h	
Central lock	



ORD. NO.	DRAWERS
F AE 3040 11 04	3
Cabinet with 3 drawers	
2 retractable shelves	
Dim. mm 717x750x1000 h	
Central lock	



ORD. NO.	DRAWERS
F AE 3040 12 04	5
Cabinet with 5 drawers	
1 retractable shelf	
Dim. mm 717x750x1000 h	
Central lock	



ORD. NO.	DRAWERS
F AE 3040 13 04	5
Cabinet with 5 drawers	
1 retractable shelf	
Dim. mm 717x750x1000 h	
Central lock	



ORD. NO.	DRAWERS
F AE 3040 14 04	4
Cabinet with 4 drawers	
Dimensions mm 717x750x1000 h	
Central lock	



ORD. NO.	DRAWERS
F AE 3040 15 04	2
Cabinet with 2 drawers	
2 retractable shelves	
Dim. mm 717x750x1000 h	
Central lock	

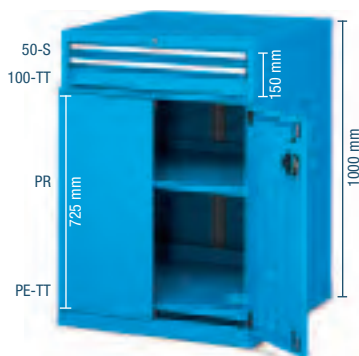

ORD. NO.	DRAWERS
F AE 3040 17 04	2
Cabinet with 2 drawers	
1 retractable shelf, 1 adjustable shelf	
Dim. mm 717x750x1000 h	
Central lock	

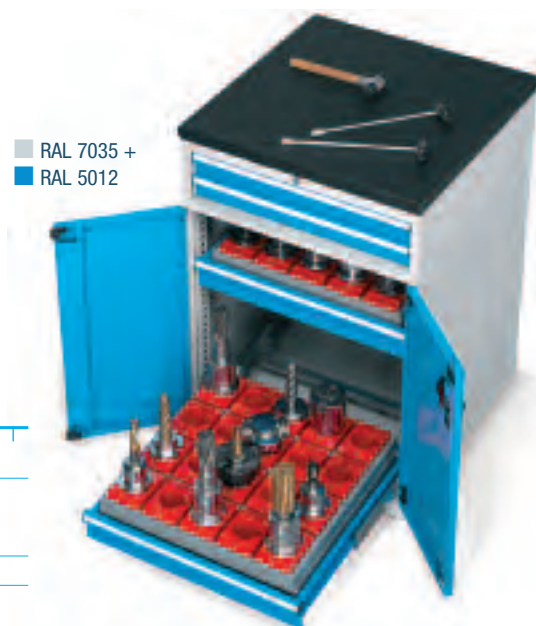

CABINET WITH LEAF DOORS

ORD. NO.
F AE 3040 S1 50
complete with 4 drawers, 2 tool holder frames with supports, 1 rubber cover MDF top
Dimensions mm 717x750x1030 h
Tools and tool holders excluded.

KEY

RAL 7000 F.01 RAL 6011 F.02 RAL 5012 F.04 RAL 7035 F.08



- TT = telescopic full extension (100%)
- PE-TT = full telescopic retractable shelf (100%)
- S = normal extension (87%)
- PR = height adjustable shelf

■ The cabinets must be secured to the floor or to the wall



CABINETS SERIES STANDARD F36

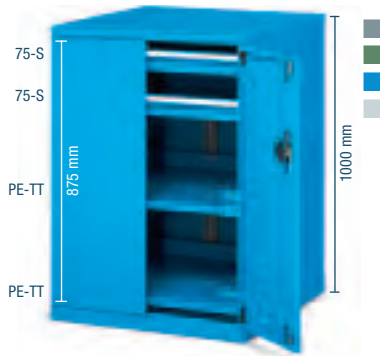

ORD. NO.	DRAWERS
F AE 4040 01 04	2
Cabinet with 2 drawers	
2 retractable shelves	
Dimensions mm 717x750x1000 h	



ORD. NO.	DRAWERS
F AE 4040 08 04	6
Cabinet with 6 drawers	
Dimensions mm 717x750x1000 h	



ORD. NO.	DRAWERS
F AE 4040 09 04	3
Cabinet with 3 drawers	
Dimensions mm 717x750x1000 h	

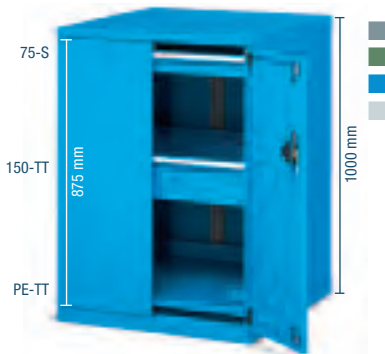

ORD. NO.	DRAWERS
F AE 4040 10 04	2
Cabinet with 2 drawers	
1 retractable shelf	
Dimensions mm 717x750x1000 h	



ORD. NO.	DRAWERS
F AE 4040 11 04	2
Cabinet with 2 drawers	
1 retractable shelf	
Dimensions mm 717x750x1000 h	



ORD. NO.	DRAWERS
F AE 4040 12 04	3
Cabinet with 3 drawers	
1 retractable shelf	
Dimensions mm 717x750x1000 h	



ORD. NO.	DRAWERS
F AE 4040 13 04	3
Cabinet with 3 drawers	
2 retractable shelves	
Dimensions mm 717x750x1000 h	



ORD. NO.	DRAWERS
F AE 4040 14 04	4
Cabinet with 4 drawers	
1 retractable shelf	
Dimensions mm 717x750x1000 h	



ORD. NO.	DRAWERS
F AE 4040 15 04	3
Cabinet with 3 drawers	
Dimensions mm 717x750x1000 h	

RAL 7000 F.01

RAL 6011 F.02

RAL 5012 F.04

RAL 7035 F.08

KEY ■

■ The cabinets must be secured to the floor or to the wall

- TT = telescopic full extension (100%)
- PE-TT = full telescopic retractable shelf (100%)
- S = normal extension (87%)



LENGTH = 717 mm DEPTH = 750/785 mm (36x36 Eh)

CABINETS SERIES STANDARD F36



ORD. NO.	DRAWERS
F AE 4058 02 04	5
Cabinet with 5 drawers	
Dimensions mm 717x750x1450 h	

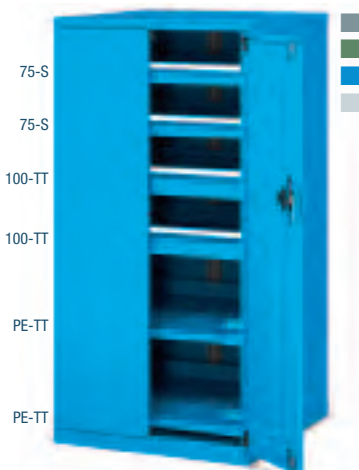

ORD. NO.	DRAWERS
F AE 4058 04 04	4
Cabinet with 4 drawers, 2 retractable shelves	
Dimensions mm 717x750x1450 h	



ORD. NO.	DRAWERS
F AE 4058 08 04	3
Cabinet with 3 drawers, 2 retractable shelves	
Dimensions mm 717x750x1450 h	



ORD. NO.	DRAWERS
F AE 4058 12 04	8
Cabinet with 8 drawers	
Dimensions mm 717x750x1450 h	

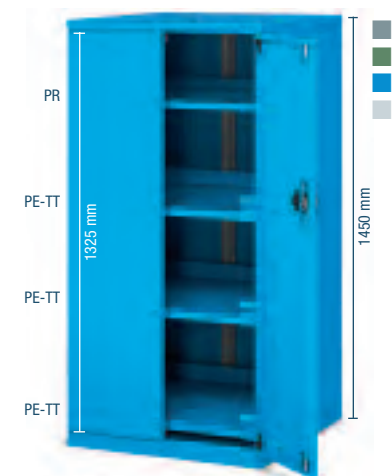

ORD. NO.	SHELVES
F AE 4058 10 04	4
Cabinet with 3 retractable shelves, 1 adjustable shelf	
Dimensions mm 717x750x1450 h	



CABINET WITH LEAF DOORS

ORD. NO.
F AE 4058 S1 01
complete with 3 drawers, 2 retractable shelves, 1 tool holder frame, 1 rubber cover top with 3 edges
Dim. mm 717x750x1470 h Tools and tool holders excluded

KEY



- TT = telescopic full extension (100%)
- PE-TT = full telescopic retractable shelf (100%)
- S = normal extension (87%)
- PR = height adjustable shelf

■ RAL 7000 F.01 ■ RAL 6011 F.02 ■ RAL 5012 F.04 ■ RAL 7035 F.08

■ The cabinets must be secured to the floor or to the wall



CABINETS SERIES STANDARD F36



•ORD. NO. DRAWERS
F AF 3040 04 04 4
 Cabinet with 4 drawers, 4 retractable shelves
 Dimensions mm 1431x785x1000 h



•ORD. NO. DRAWERS
F AF 3040 06 04 6
 Cabinet with 6 drawers
 Dimensions mm 1431x785x1000 h



ORD. NO. DRAWERS
F AF 3040 10 04 4
 Cabinet with 4 drawers, 2 retractable shelves
 Dimensions mm 1431x785x1000 h



•ORD. NO. DRAWERS
F AF 3040 12 04 12
 Cabinet with 12 drawers
 Dimensions mm 1431x785x1000 h



•ORD. NO. DRAWERS
F AF 3040 14 04 8
 Cabinet with 8 drawers, 2 retractable shelves
 Dimensions mm 1431x785x1000 h



•ORD. NO. DRAWERS
F AF 3040 13 04 8
 Cabinet with 8 drawers
 Dimensions mm 1431x785x1000 h

RAL 7000 F.01 RAL 6011 F.02 RAL 5012 F.04 RAL 7035 F.08

KEY ■

- TT = telescopic full extension (100%)
- PE-TT = full telescopic retractable shelf (100%)
- S = normal extension (87%)

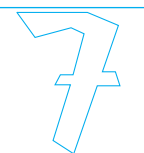

■ The cabinets must be secured to the floor or to the wall

LENGTH = 717 mm DEPTH = 750/785 mm (36x36 Eh)

CABINETS SERIES STANDARD F36



ORD. NO.	DRAWERS
F AF 3040 15 04	2
Cabinet with 2 drawers, 6 retractable shelves	
Dimensions mm 1431x785x1000 h	

CABINET WITH SLIDING DOORS

ORD. NO.
F AF 3040 S1 08
complete with 4 drawers, 2 retractable shelves
2 tool holder frames
1 rubber cover top with 3 edges
Dimensions mm 1431x785x1020 h
Tools and tool holders excluded



KEY

RAL 7000 F.01 RAL 6011 F.02 RAL 5012 F.04 RAL 7035 F.08



- PE-TT = full telescopic retractable shelf (100%)
- S = normal extension (87%)

■ The cabinets must be secured to the floor or to the wall

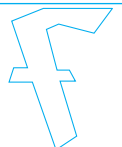

CABINETS SERIES STANDARD F36

EMPTY CABINET (FA100)



■ 01
■ 02
■ 04
■ 08

ORD. NO. LOAD CAPACITY kg

F AE 3040 00 04 3000

Dimensions mm 717x750x1000 h

Usable height mm 150+725

Cabinet including 2 cylinder locks and 4 keys

ORD. NO.

R CSR 0003 00

Spare lock (for cabinet)

R CSR 0008 00

Spare lock (for door)

R XAE 0001 99

Pair of spare rod (for door)

EMPTY CABINET (F100 - F145)



■ 01
■ 02
■ 04
■ 08

ORD. NO. LOAD CAPACITY kg

F AE 4040 00 04 3000

Dimensions mm 717x750x1000 h

Usable height mm 875

F AE 4058 00 04 3000

Dimensions mm 717x750x1450 h

Usable height mm 1325

Cabinet including cylinder lock and 2 keys

ORD. NO.

R CSR 0008 00

Spare lock (for door)

R XAE 0002 99

Pair of spare rod (for door) cabinet F AE 4040

R XAE 0003 99

Pair of spare rod (for door) cabinet F AE 4058

EMPTY CABINET (FC100)



■ 01
■ 02
■ 04
■ 08

ORD. NO. LOAD CAPACITY kg

F AF 3040 00 04 1500+1500

Dimensions mm 1431x785x1000 h

Usable height mm 875

Cabinet including cylinder lock and 2 keys

ORD. NO.

R CSR 0012 00

Spare lock (for door)

■ Spare key see page A158

■ The cabinet must be secured to the floor or to the wall. Further information for fixing set see page A158.

NORMAL EXTENSION DRAWERS (S)

ORD. NO.	FRONT HEIGHT mm	LOAD CAPACITY kg	USABLE DIMENSIONS mm
F FG 2005 00 04	50	60	600x600x36 h
F FG 2007 00 04	75	80	600x600x61 h
F FG 2010 00 04	100	100	600x600x86 h
F FG 2012 00 04	125	100	600x600x111 h
F FG 2015 00 04	150	100	600x600x136 h
F FG 2017 00 04	175	100	600x600x161 h
F FG 2020 00 04	200	100	600x600x186 h
F FG 2030 00 04	300	100	600x600x286 h

Normal extension (87%)

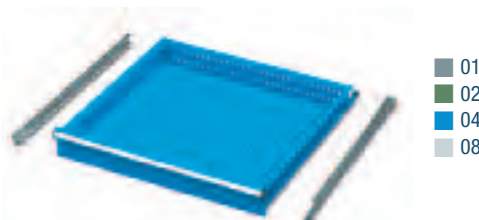

■ 01
■ 02
■ 04
■ 08

■ Partitioning material: see page A96-A97

FULL TELESCOPIC EXTENSION DRAWERS (TT)

ORD. NO.	FRONT HEIGHT mm	LOAD CAPACITY kg	USABLE DIMENSIONS mm
F FG 2107 00 04	75	200	600x600x54 h
F FG 2110 00 04	100	200	600x600x79 h
F FG 2112 00 04	125	200	600x600x104 h
F FG 2115 00 04	150	200	600x600x129 h
F FG 2117 00 04	175	200	600x600x154 h
F FG 2120 00 04	200	200	600x600x179 h
F FG 2125 00 04	250	200	600x600x229 h
F FG 2130 00 04	300	200	600x600x279 h
F FG 2140 00 04	400	200	600x600x379 h

Full telescopic extension (100%)



■ 01
■ 02
■ 04
■ 08

■ Partitioning material: see page A96-A97

NORMAL EXTENSION SHELVES (PE-S)

ORD. NO.	SIDE HEIGHT mm	LOAD CAPACITY kg	USABLE DIMENSIONS mm
F FG 8020 00 04	-	100	610x610

Normal extension (87%)

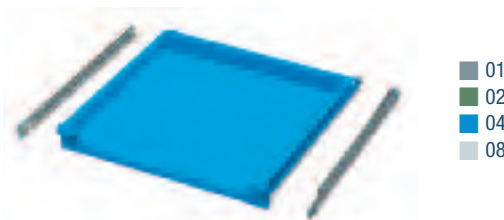

■ 01
■ 02
■ 04
■ 08

LENGTH = 717 mm DEPTH = 750/785 mm (36x36 Eh)

CABINETS SERIES STANDARD F36

FULL TELESCOPIC EXTENSION SHELVES (PE-TT)

ORD. NO.	SIDE HEIGHT mm	LOAD CAPACITY kg	USABLE DIMENSIONS mm
F FG 8120 00 04	-	200	610x610

Full telescopic extension (100%)

ADJUSTABLE SHELVES

ORD. NO.	SIDE HEIGHT mm	LOAD CAPACITY kg	USABLE DIMENSIONS mm
F SR 1260 01 04	25	150	618x618

Without extension system

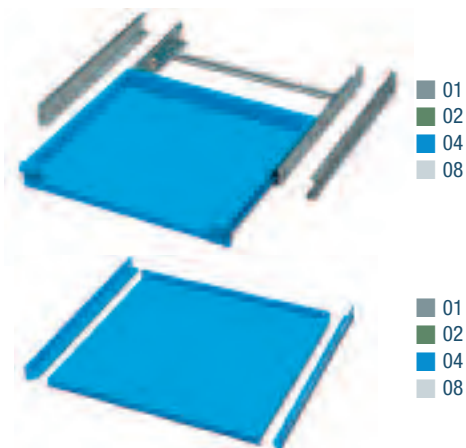

CABINET TO CABINET FIXING

■ The article includes:
4 M8 nuts and bolts.
Suitable for fixing same series cabinets only.

ORD. NO. F AG 9202 00 99



TWO SIDED ADHESIVE TAPE

ORD. NO.

R CMV 0025 00

width 15 mm
length 50 metres



■ 07

PLINTHS

For cabinet F AE 3040 - F AE 4040 - F AE 4058

ORD. NO.

F RR 0080 00 07

Plinths height 50 mm



■ 07

PLINTHS

For cabinet F AF 3040

ORD. NO.

F RR 0145 00 07

Plinths height 50 mm



■ 07

PLINTHS FOR TRANSPALLET

For cabinet F AE 3040 - F AE 4040 - F AE 4058

ORD. NO.

F RR 0315 00 07 Plinths height 100 mm

F RR 0405 00 07 Facing piece



■ 07

PLINTHS FOR TRANSPALLET

For cabinet F AF 3040

ORD. NO.

F RR 0255 00 07 Pair of plinths height 100 mm

F RR 0445 00 07 Facing piece

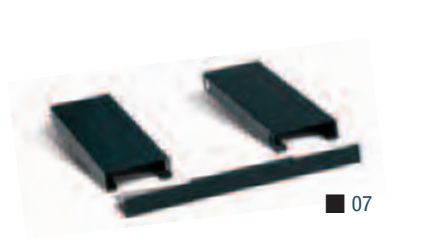

■ 07

PLINTHS FOR FORK LIFT TRUCK

For cabinet F AE 3040 - F AE 4040 - F AE 4058

ORD. NO.

F RR 0240 00 07 Pair of plinths height 60 mm

F RR 0400 00 07 Facing piece



■ 07

PLINTHS FOR FORK LIFT TRUCK

For cabinet F AF 3040

ORD. NO.

F RR 0250 00 07 Pair of plinths height 60 mm

F RR 0440 00 07 Facing piece

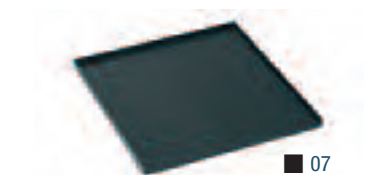

■ 07

TOP SHELF

For cabinet F AE 3040

ORD. NO.

F AG 9003 01 07 717x726x20 h

oil-resistant rubber cover top with 3 edges

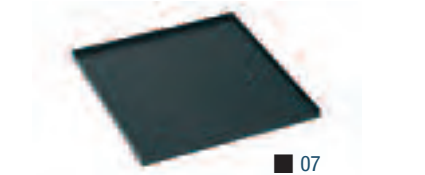

■ 07

TOP SHELF

For cabinet F AE 4040 - F AE 4058

ORD. NO.

F AE 9009 01 07 717x750x20 h

oil-resistant rubber cover top with 3 edges



■ 07

TOP SHELF

For cabinet F AF 3040

ORD. NO.

F AF 9006 01 07 1431x785x20 h

oil-resistant rubber cover top with 3 edges



ORD. NO. F AE 8058 21 04

FLOOR FIXING SET

2x

- 2 "HILTI" plugs for concrete floors \geq to classes B25/RBK250/MPa 25 N/mm²
- Recommended traction of the plug: 2.9 KN
- Plug diameter: \varnothing 6 mm

ORD. NO. F AG 9204 00 99

CABINET FLOOR FIXING SET

- Pair of spare galvanised brackets
- \varnothing 6 mm hole



ORD. NO. F AG 9200 00 99

RAL 7000 F.01

RAL 6011 F.02

RAL 5012 F.04

RAL 7035 F.08

SUPPLEMENTARY PARTS ■

- **Spare key.** Always indicate the number on the cylinder lock of the key to be replaced.

ORD. NO. R CSC 0002 00

- **Master key.** This type of key opens all the 45 and 46 series locks.

ORD. NO. R CSC 0001 00



LENGTH = 717 mm DEPTH = 750 mm (36x36 Eh)

CABINETS SERIES STANDARD FO



ORD. NO.	SHELVES
F AE 8058 01 04	2
Cabinet complete with: 2 full extension retractable shelves (200 kg), 4 plastic cans 25 litres capacity, 5 plastic cans 10 litres capacity, 1 retractable safety tank for oil 40 litres capacity.	
Total useful capacity of the cabinet:	150 litres
Capacity of safety tank for oil:	40 litres
Dimensions mm 717x750x1450 h	



ORD. NO.	SHELVES
F AE 8058 21 04	2
Cabinet complete with: 2 full extension retractable shelves (200 kg), 4 plastic cans 25 litres capacity, 5 plastic cans 10 litres capacity, 1 plastic drip tray 10 litres capacity, 1 safety tank for oil 77 litres capacity, 2 plugs for tank.	
Total useful capacity of the cabinet:	150 litres
Capacity of safety tank for oil:	77 litres
Dimensions mm 717x750x1600 h	



ORD. NO.	SHELVES
F AE 8058 41 04	2
Cabinet complete with: 2 full extension retractable shelves (200 kg), 4 plastic cans 25 litres capacity, 5 plastic cans 10 litres capacity, 1 retractable safety tank for oil 40 litres capacity, 1 safety tank for oil 77 litres capacity, 2 plugs for tank.	
Total useful capacity of the cabinet:	150 litres
Total capacity of safety tanks for oil:	117 litres
Dimensions mm 717x750x1600 h	



ORD. NO.	SHELVES
F AE 8058 02 04	3
Cabinet complete with: 3 full extension retractable shelves (200 kg), 4 plastic cans 25 litres capacity, 10 plastic cans 10 litres capacity, 1 retractable safety tank for oil 40 litres capacity.	
Total useful capacity of the cabinet:	200 litres
Capacity of safety tank for oil:	40 litres
Dimensions mm 717x750x1450 h	



ORD. NO.	SHELVES
F AE 8058 22 04	3
Cabinet complete with: 3 full extension retractable shelves (200 kg), 4 plastic cans 25 litres capacity, 10 plastic cans 10 litres capacity, 1 plastic drip tray 10 litres capacity, 1 safety tank for oil 77 litres capacity, 2 plugs for tank.	
Total useful capacity of the cabinet:	200 litres
Capacity of safety tank for oil:	77 litres
Dimensions mm 717x750x1600 h	



ORD. NO.	SHELVES
F AE 8058 42 04	3
Cabinet complete with: 3 full extension retractable shelves (200 kg), 4 plastic cans 25 litres capacity, 10 plastic cans 10 litres capacity, 1 retractable safety tank for oil 40 litres capacity, 1 safety tank for oil 77 litres capacity, 2 plugs for tank.	
Total useful capacity of the cabinet:	200 litres
Total capacity of safety tanks for oil:	117 litres
Dimensions mm 717x750x1600 h	

■ KEY

RAL 7000 F.01

RAL 6011 F.02

RAL 5012 F.04

RAL 7035 F.08



- The cabinets must be secured to the floor or to the wall

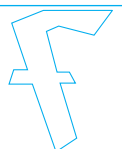

CABINETS SERIES STANDARD FO



ORD. NO.	SHELVES
F AE 8058 03 04	2

Cabinet complete with:

2 full extension retractable shelves (200 kg),
8 plastic cans 25 litres capacity,
1 retractable safety tank for oil 40 litres capacity

Total useful capacity of the cabinet: 200 litres

Capacity of safety tank for oil: 40 litres

Dimensions mm 717x750x1450 h



ORD. NO.	SHELVES
F AE 8058 23 04	2

Cabinet complete with: 2 full extension retractable shelves (200 kg), 8 plastic cans 25 litres capacity, 1 plastic drip tray 10 litres capacity, 1 safety tank for oil 77 litres capacity, 2 plugs for tank.

Total useful capacity of the cabinet: 200 litres

Capacity of safety tank for oil: 77 litres

Dimensions mm 717x750x1600 h



ORD. NO.	SHELVES
F AE 8058 43 04	2

Cabinet complete with: 2 full extension retractable shelves (200 kg), 8 plastic cans 25 litres capacity, 1 retractable safety tank for oil 40 litres capacity, 1 safety tank for oil 77 litres capacity, 2 plugs for tank.

Total useful capacity of the cabinet: 200 litres

Total capacity of safety tanks for oil: 117 litres

Dimensions mm 717x750x1600 h



RAL 7000 F.01

RAL 6011 F.02

RAL 5012 F.04

RAL 7035 F.08

KEY ■

- The cabinets must be secured to the floor or to the wall



LENGTH = 717 mm DEPTH = 750 mm (36x36 Eh)

CABINETS SERIES STANDARD FO

**ORD. NO.****SHELVES****F AE 8058 04 04****4**

Cabinet complete with:

4 full extension retractable shelves (200 kg),
20 plastic cans 10 litres capacity,
1 retractable safety tank for oil 23 litres capacity

Total useful capacity of the cabinet: 200 litres

Capacity of safety tank for oil: 23 litres

Dimensions mm 717x750x1450 h**ORD. NO.****SHELVES****F AE 8058 24 04****4**

Cabinet complete with: 4 full extension retractable
shelves (200 kg), 20 plastic cans 10 litres capacity,
1 plastic drip tray 10 litres capacity,
1 safety tank for oil 77 litres capacity,
2 plugs for tank.

Total useful capacity of the cabinet: 200 litres

Capacity of safety tank for oil: 77 litres

Dimensions mm 717x750x1600 h**ORD. NO.****SHELVES****F AE 8058 44 04****4**

Cabinet complete with: 4 full extension retractable
shelves (200 kg), 20 plastic cans 10 litres capacity,
1 retractable safety tank for oil 23 litres capacity,
1 safety tank for oil holding 77 litres, 2 plugs for tank.

Total useful capacity of the cabinet: 200 litres

Total capacity of safety tanks for oil: 100 litres

Dimensions mm 717x750x1600 h**KEY**

RAL 7000 F.01

RAL 6011 F.02

RAL 5012 F.04

RAL 7035 F.08



- The cabinets must be secured to the floor or to the wall

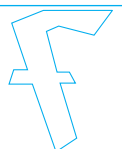

CABINETS SERIES STANDARD FO

LENGTH = 717 mm DEPTH = 750 mm (36x36 Eh)



ORD. NO.	SHELVES
F AE 8058 05 04	3
Cabinet complete with: 2 full extension retractable shelves (200 kg), 4 plastic cans 25 litres capacity, 5 plastic cans 10 litres capacity, 1 height adjustable shelf (150 kg) 618 mm deep, 1 retractable safety tank for oil 40 litres capacity.	
Total useful capacity of the cabinet:	150 litres
Capacity of safety tank for oil:	40 litres
Dimensions mm 717x750x1450 h	



ORD. NO.	SHELVES
F AE 8058 25 04	3
Cabinet complete with: 2 full extension retractable shelves (200 kg), 4 plastic cans 25 litres capacity, 5 plastic cans 10 litres capacity, 1 height adjustable shelf (150 kg) 618 mm deep, 1 plastic drip tray 10 litres capacity, 1 safety tank for oil 77 litres capacity, 2 plugs for tank.	
Total useful capacity of the cabinet:	150 litres
Capacity of safety tank for oil:	77 litres
Dimensions mm 717x750x1600 h	



ORD. NO.	SHELVES
F AE 8058 45 04	3
Cabinet complete with: 2 full extension retractable shelves (200 kg), 4 plastic cans 25 litres capacity, 5 plastic cans 10 litres capacity, 1 height adjustable shelf (150 kg) 618 mm deep, 1 retractable safety tank for oil 40 litres capacity, 1 safety tank for oil 77 litres capacity, 2 plugs for tank.	
Total useful capacity of the cabinet:	150 litres
Total capacity of safety tanks for oil:	117 litres
Dimensions mm 717x750x1600 h	



ORD. NO. F AE 8058 42 04



ORD. NO. F AE 8058 25 04

RAL 7000 F.01

RAL 6011 F.02

RAL 5012 F.04

RAL 7035 F.08

SUPPLEMENTARY PARTS ■



■ The cabinets must be secured to the floor or to the wall



■ **Spare key.** Always indicate the number on the cylinder lock of the key to be replaced.

ORD. NO. R CSC 0002 00

■ **Master key.** This type of key opens all the 45 and 46 series locks.

ORD. NO. R CSC 0001 00



LENGTH = 717 mm DEPTH = 750 mm (36x36 Eh)

CABINETS SERIES STANDARD FO



■ INFO

RAL 7000 F.01

RAL 6011 F.02

RAL 5012 F.04

RAL 7035 F.08



www.famispa.com

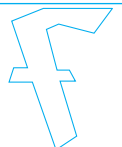

CABINETS SERIES STANDARD CS



FLOOR FIXING SET



2x

- 2 "HILTI" plugs for concrete floors \geq to classes B25/RBK250/MP_A 25 N/mm²
- Recommended traction of the plug: 2.9 KN
- Plug diameter: \varnothing 6 mm

ORD. NO. F AG 9204 00 99

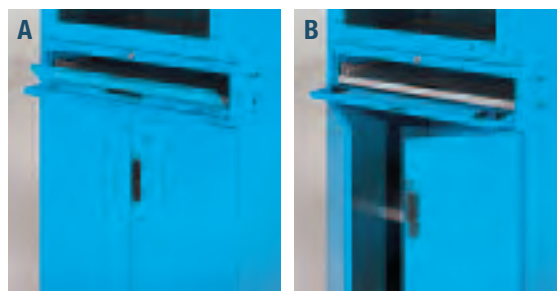

The lock on the door in figure **A** closes or opens the lower door in figure **B** at the same time

RAL 7000 F.01

RAL 6011 F.02

RAL 5012 F.04

RAL 7035 F.08

SUPPLEMENTARY PARTS ■

■ **Spare key.** Always indicate the number on the cylinder lock of the key to be replaced.

ORD. NO. R CSC 0002 00

■ **Master key.** This type of key opens all the 45 and 46 series locks.

ORD. NO. R CSC 0001 00



LENGTH = 717 mm DEPTH = 635 mm

CABINETS SERIES STANDARD CS

Polycarbonate door with safety lock.
Useful dimensions: 660x525 mm h.

Suitable for monitor sizes up to 21".
Internal dimensions of upper compartment: 690x600x580 mm h.

Retractable keyboard shelf.
Useful dimensions: 620x510 mm h.

The lower compartment can be fitted with retractable and height adjustable shelves for housing hardware systems and printers.
Internal dimensions : 690x600x720 mm h.

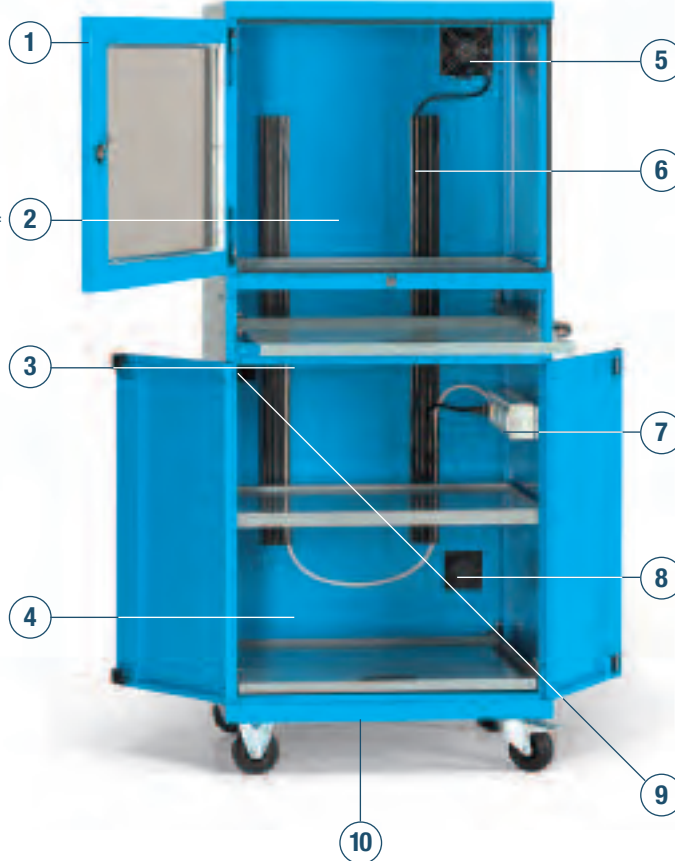

5 Cooling fan with dust filter.

6 4-channel cable duct.

7 5-socket electrical system with circuit breaker.

8 Air inlet hole with dust filter.

9 Inlet hole for network cables and outlet hole for power cable.

Room temperature for use -5/+40 °C with umidity up to 50%
Room temperature for use -5/+20 °C with umidity up to 90%

3 The retractable keyboard shelf can be locked in two different positions and it is generously sized to make place for work accessories and make it more comfortable to use the keyboard. 1 mouse pad, 2 floor brackets, 12 plastic caps and 2 levelling devices are supplied standard with the cabinet.



■ **Cabinet with or without plinths**
Cabinet load capacity: 400 kg
Load capacity of the adjustable shelf: 100 kg
Load capacity of the retractable shelf: 50 kg

■ **Cabinet with wheels**
Cabinet load capacity: 400 kg.
Load capacity of the adjustable shelf: 100 kg
Load capacity of the retractable shelf: 25 kg*

*Attention: the load capacity may be increased by 100% if the cabinet already contains a 50 kg load.

7 The electrical system (protected by IP 30) of each computer cabinet is standard supplied with a 230V 10A circuit breaker and tested with a special tester according to the CEI EN 60204-1, with the following tests:
- continuity of the earth circuit
- applied voltage
- insulation resistance



9 Adjust the external length of the power cable by unscrewing the relative cable holder. The dual protection power cable is 3 metres long.

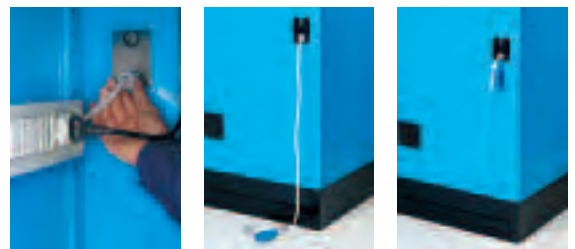

■ KEY

RAL 7000 F.01 RAL 6011 F.02 RAL 5012 F.04 RAL 7035 F.08



■ All indicated loads are net and refer to evenly distributed weights

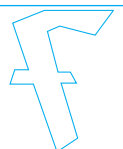

CABINETS SERIES STANDARD CS

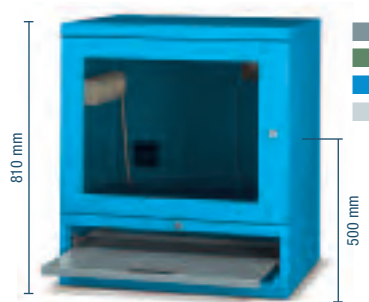
**Dimensions mm 717x635x810 h**

Complete with: 1 height adjustable shelf, 1 retractable keyboard shelf

Computer cabinet **ORD. NO. F AS 0801 11 08**

ORD. NO. with 1 fan	type and number of wired sockets:					
	D	F	GB	I	CH	IL
F AS 0801 11 04	5	-	-	-	-	-
F AS 0801 21 04	2	3	-	-	-	-
F AS 0801 31 04	2	-	2	-	-	-
F AS 0801 41 04	2	-	-	3	-	-
F AS 0801 51 04	2	-	-	-	3	-
F AS 0801 71 04	2	-	-	-	-	3

ORD. NO. with 2 fans	type and number of wired sockets:					
	D	F	GB	I	CH	IL
F AS 0802 11 04	5	-	-	-	-	-
F AS 0802 21 04	2	3	-	-	-	-
F AS 0802 31 04	2	-	2	-	-	-
F AS 0802 41 04	2	-	-	3	-	-
F AS 0802 51 04	2	-	-	-	3	-
F AS 0802 71 04	2	-	-	-	-	3



RAL 7035



LENGTH = 717 mm DEPTH = 635 mm

CABINETS SERIES STANDARD CS

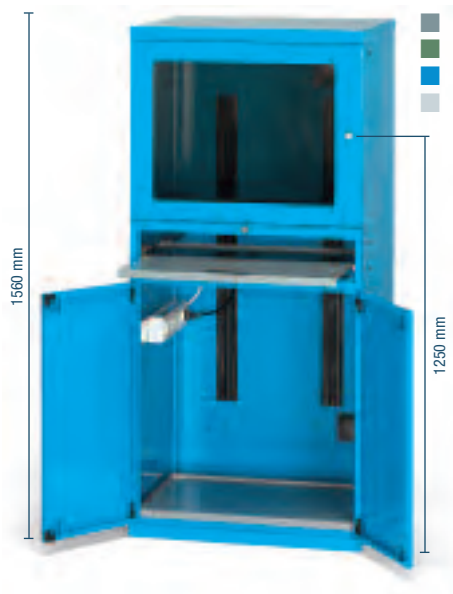

Dimensions mm 717x635x1560 h
complete with: 2 height adjustable shelves, 1 retractable keyboard shelf

ORD. NO. with 1 fan	type and number of wired sockets:					
	D	F	GB	I	CH	IL
F AS 1601 11 04	5	-	-	-	-	-
F AS 1601 21 04	2	3	-	-	-	-
F AS 1601 31 04	2	-	2	-	-	-
F AS 1601 41 04	2	-	-	3	-	-
F AS 1601 51 04	2	-	-	-	3	-
F AS 1601 71 04	2	-	-	-	-	3

ORD. NO. with 2 fans	type and number of wired sockets:					
	D	F	GB	I	CH	IL
F AS 1602 11 04	5	-	-	-	-	-
F AS 1602 21 04	2	3	-	-	-	-
F AS 1602 31 04	2	-	2	-	-	-
F AS 1602 41 04	2	-	-	3	-	-
F AS 1602 51 04	2	-	-	-	3	-
F AS 1602 71 04	2	-	-	-	-	3

can contain big tower



Computer cabinet
ORD. NO. F AS 1601 12 04
with 2 multi-purpose supports
ORD. NO. F AS 2250 00 07

"Dark light" lamp with three joints
ORD. NO. F BL 9980 00 08



Cabinet with writing desk ORD. NO. F AA 0110 00 04 Polyurethane chair ORD. NO. F QZ 2211 00 07

KEY

- RAL 7000 F.01
- RAL 6011 F.02
- RAL 5012 F.04
- RAL 7035 F.08



The cabinets must be secured to the floor



CABINETS SERIES STANDARD CS

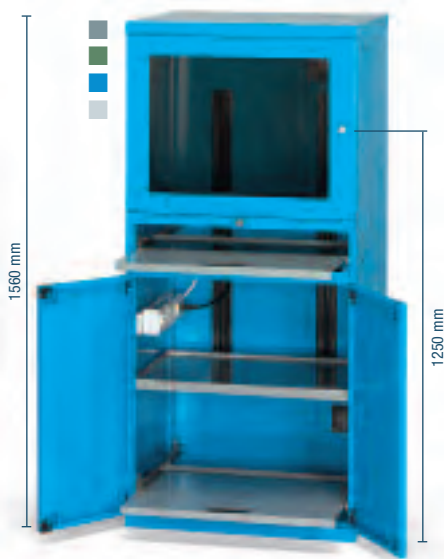

Dim. mm 717x635x1560 h
Complete with:
2 height adjustable shelves
1 retractable keyboard shelf
1 retractable shelf

ORD. NO. with 1 fan	type and number of wired sockets:					
	D	F	GB	I	CH	IL
F AS 1601 12 04	5	-	-	-	-	-
F AS 1601 22 04	2	3	-	-	-	-
F AS 1601 32 04	2	-	2	-	-	-
F AS 1601 42 04	2	-	-	3	-	-
F AS 1601 52 04	2	-	-	-	3	-
F AS 1601 72 04	2	-	-	-	-	3

ORD. NO. with 2 fans	type and number of wired sockets:					
	D	F	GB	I	CH	IL
F AS 1602 12 04	5	-	-	-	-	-
F AS 1602 22 04	2	3	-	-	-	-
F AS 1602 32 04	2	-	2	-	-	-
F AS 1602 42 04	2	-	-	3	-	-
F AS 1602 52 04	2	-	-	-	3	-
F AS 1602 72 04	2	-	-	-	-	3

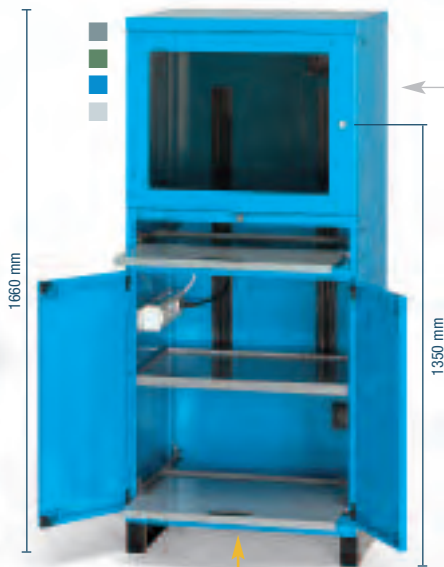

Dim. mm 717x635x1660 h
Complete with:
2 height adjustable shelves
1 retractable keyboard shelf
1 retractable shelf
1 pair of 100 mm h base plinths without facing piece

Facing piece for base plinths 100 mm h

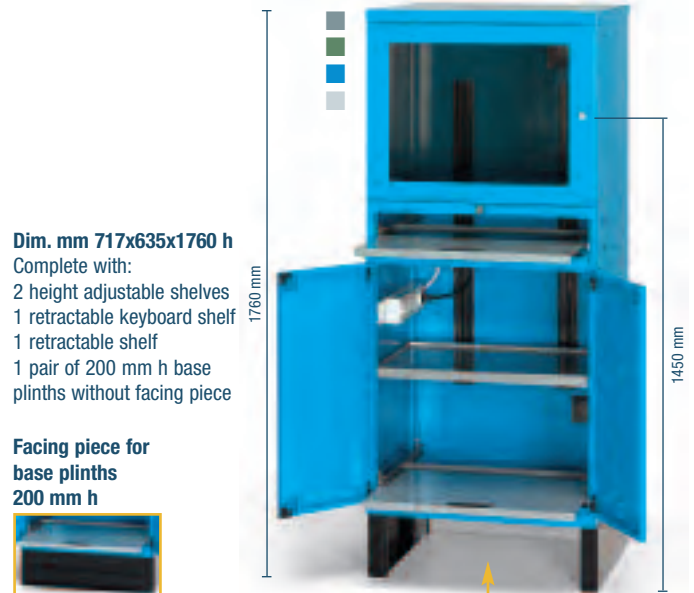

Dim. mm 717x635x1760 h
Complete with:
2 height adjustable shelves
1 retractable keyboard shelf
1 retractable shelf
1 pair of 200 mm h base plinths without facing piece

Facing piece for base plinths 200 mm h



ORD. NO. with 1 fan	type and number of wired sockets:					
	D	F	GB	I	CH	IL
F AS 1601 14 04	5	-	-	-	-	-
F AS 1601 24 04	2	3	-	-	-	-
F AS 1601 34 04	2	-	2	-	-	-
F AS 1601 44 04	2	-	-	3	-	-
F AS 1601 54 04	2	-	-	-	3	-
F AS 1601 74 04	2	-	-	-	-	3

ORD. NO. with 2 fans	type and number of wired sockets:					
	D	F	GB	I	CH	IL
F AS 1602 14 04	5	-	-	-	-	-
F AS 1602 24 04	2	3	-	-	-	-
F AS 1602 34 04	2	-	2	-	-	-
F AS 1602 44 04	2	-	-	3	-	-
F AS 1602 54 04	2	-	-	-	3	-
F AS 1602 74 04	2	-	-	-	-	3

ORD. NO. with 1 fan	type and number of wired sockets:					
	D	F	GB	I	CH	IL
F AS 1601 15 04	5	-	-	-	-	-
F AS 1601 25 04	2	3	-	-	-	-
F AS 1601 35 04	2	-	2	-	-	-
F AS 1601 45 04	2	-	-	3	-	-
F AS 1601 55 04	2	-	-	-	3	-
F AS 1601 75 04	2	-	-	-	-	3

ORD. NO. with 2 fans	type and number of wired sockets:					
	D	F	GB	I	CH	IL
F AS 1602 15 04	5	-	-	-	-	-
F AS 1602 25 04	2	3	-	-	-	-
F AS 1602 35 04	2	-	2	-	-	-
F AS 1602 45 04	2	-	-	3	-	-
F AS 1602 55 04	2	-	-	-	3	-
F AS 1602 75 04	2	-	-	-	-	3

RAL 7000 F.01

RAL 6011 F.02

RAL 5012 F.04

RAL 7035 F.08

SUPPLEMENTARY PARTS ■



■ All indicated loads are net and refer to evenly distributed weights



- 2 "HILTI" plugs for concrete floors \geq to classes B25/RBK250/MPa 25 N/mm²
- Recommended traction of the plug: 2.9 KN
- Plug diameter: \varnothing 6 mm

ORD. NO. F AG 9204 00 99



LENGTH = 717 mm DEPTH = 635 mm

CABINETS SERIES STANDARD CS

MULTI-PURPOSE SUPPORT



ORD. NO. F AS 2250 00 07

07



4 position for the multi-purpose support (2 to the right side and 2 to the left side of the cabinet).



Cabinet **ORD. NO. F AS 1601 15 04** with base plinth and facing piece **ORD. NO. F RR 0645 01 07**

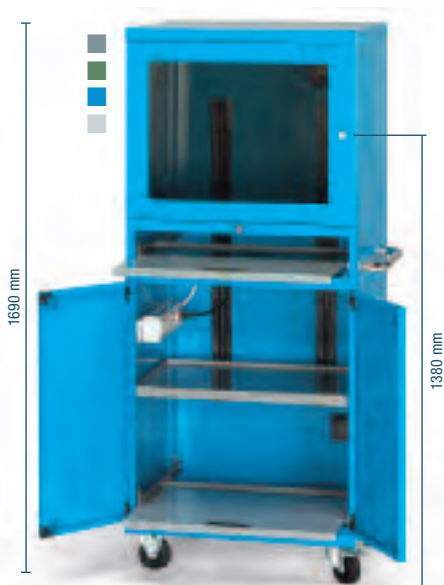

handling with a transpallet



Dim. mm 717x635x1690 h
 Complete with:
 2 height adjustable shelves
 1 retractable keyboard shelf
 1 retractable shelf
 2 swivel nylon wheels with brake
 2 fixed nylon wheels Ø 100 mm

ORD. NO. with 1 fan	type and number of wired sockets:					
	D	F	GB	I	CH	IL
F AS 1601 13 04	5	-	-	-	-	-
F AS 1601 23 04	2	3	-	-	-	-
F AS 1601 33 04	2	-	2	-	-	-
F AS 1601 43 04	2	-	-	3	-	-
F AS 1601 53 04	2	-	-	-	3	-
F AS 1601 73 04	2	-	-	-	-	3

ORD. NO. with 2 fans	type and number of wired sockets:					
	D	F	GB	I	CH	IL
F AS 1602 13 04	5	-	-	-	-	-
F AS 1602 23 04	2	3	-	-	-	-
F AS 1602 33 04	2	-	2	-	-	-
F AS 1602 43 04	2	-	-	3	-	-
F AS 1602 53 04	2	-	-	-	3	-
F AS 1602 73 04	2	-	-	-	-	3



CABINETS SERIES STANDARD CS

LENGTH = 717 mm DEPTH = 635 mm

EMPTY CABINET



ORD. NO.	LOAD CAPACITY kg
F AS 1600 01 04	400

overall dimensions mm **717x635x1560 h**Int. dim. of upper compartment mm **690x600x580 h**Int. dim. of lower compartment mm **690x600x720 h****Attention:** to the computer cabinet it is possible to apply wheels with Ø 100/125/150 mm only

- Wheels see page **A52**

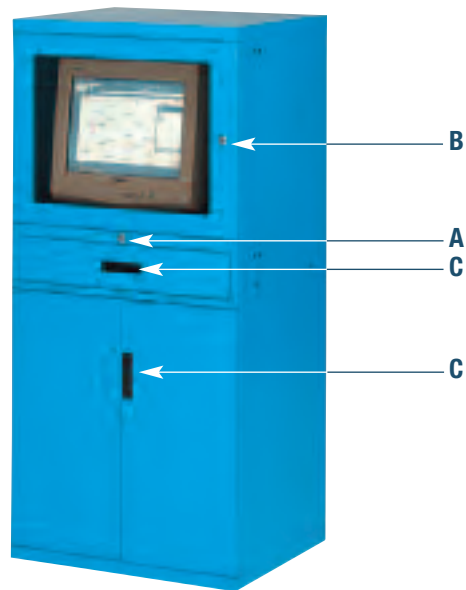

ORD. NO.
R CSR 0027 00

Spare lock (for central lock) ref. A

R CSR 0026 00

Spare lock (for polycarbonate doors) ref. B

R XAS 0002 99

Spare rod (for pair of doors)

R XDA 0002 07

Spare handle (for doors) ref. C

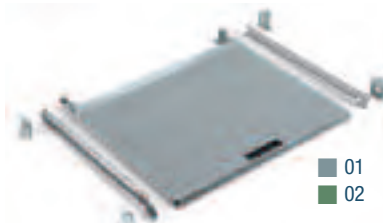

RETRACTABLE SHELF

ORD. NO.	LOAD CAPACITY kg
F AS 2360 00 01	50

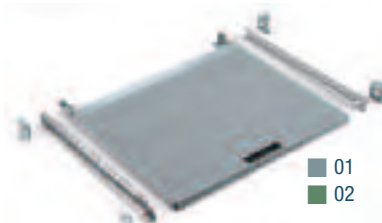
Overall dimensions mm **650x585x25 h**Usable dimensions mm **620x510**

RETRACTABLE KEYBOARD SHELF

ORD. NO.	LOAD CAPACITY kg
F AS 2350 00 01	50

Overall dimensions mm **650x585x25 h**Usable dimensions mm **620x510**

ADJUSTABLE SHELF

ORD. NO.	LOAD CAPACITY kg
F AS 2040 01 01	100

Overall dimensions mm **690x595x35 h**Usable dimensions mm **685x510**

PAIR OF PLINTHS FOR TRANSPALLET 100 mm h

ORD. NO.

F RR 1625 00 07 Plinths height 100 mm**F RR 0645 00 07** Facing piece

PAIR OF PLINTHS 200 mm h

ORD. NO.

F RR 1635 00 07 Plinths height 200 mm**F RR 0645 01 07** Facing piece

RAL 7000 F.01 RAL 6011 F.02 RAL 5012 F.04 RAL 7035 F.08

SUPPLEMENTARY PARTS ■



- All indicated loads are net and refer to evenly distributed weights



- **Spare key.** Always indicate the number on the cylinder lock of the key to be replaced.

ORD. NO. **R CSC 0002 00**

- **Master key.** This type of key opens all the 45 and 46 series locks.

ORD. NO. **R CSC 0001 00**

LENGTH = 717 mm DEPTH = 635 mm

CABINETS SERIES STANDARD CS

**PROFILE****ORD. NO.****C ME 99 018**

1000 mm long 4-channel plastic cable duct

**GRILLES****ORD. NO.****F AS 3210 00 00**

External grille complete with dust filter

**HANDLE****ORD. NO.****F AG 9300 00 07****FAN****ORD. NO.****F AS 3220 00 00**

220V wired fan complete with grilles and Schuko plug

ELECTRICAL SYSTEM

The electrical system (protected by **IP 30**) is supplied with one 230V 10A circuit breaker, five 220-250V 10A 2P+E sockets and one 220-250V 16A 2P+E heavy-duty plug

ORD. NO.	type and number of wired sockets:					
	D	F	GB	I	CH	IL
F AS 4100 10 00	5	-	-	-	-	-
F AS 4100 20 00	2	3	-	-	-	-
F AS 4100 30 00	2	-	2	-	-	-
F AS 4100 40 00	2	-	-	3	-	-
F AS 4100 50 00	2	-	-	-	3	-
F AS 4100 70 00	2	-	-	-	-	3

■ INFO

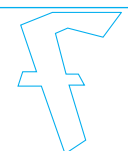

www.famispa.com

SERIES STANDARD H

1 Eh = 17 mm

**1 Eh = 17 mm**

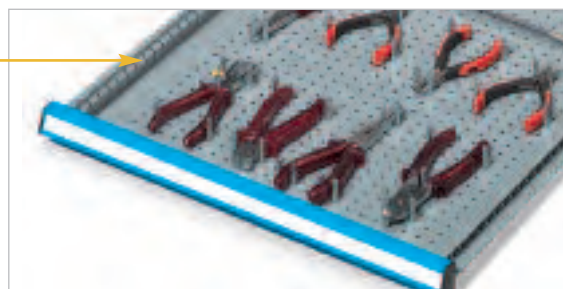
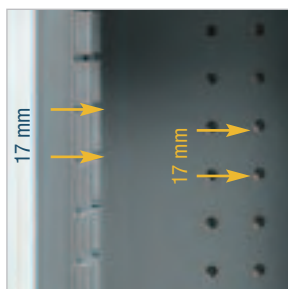
1 Eh (17 mm)
corresponds to the pitch of the slots and
of the perforations of the drawer.



1 EH = 17 mm

SERIES STANDARD H

PLAIN PARTITIONS

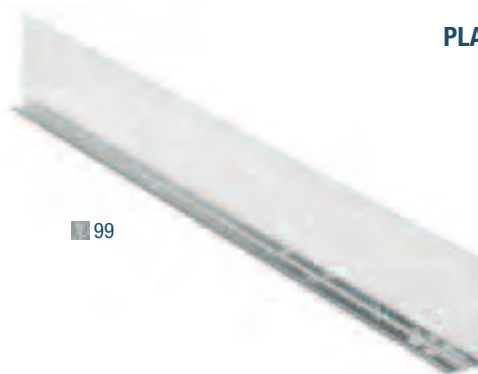

FOR FRONT HEIGHTS

	ORD. NO. Lengths 24 Eh (405 mm)	ORD. NO. Lengths 27 Eh (455 mm)	ORD. NO. Lengths 30 Eh (507 mm)	ORD. NO. Lengths 36 Eh (610 mm)	ORD. NO. Lengths 54 Eh (914 mm)	ORD. NO. Lengths 64 Eh (1085 mm)	ORD. NO. Lengths 78 Eh (1323 mm)
50	F HA 2110 00 99	F HA 2120 00 99	F HA 2130 00 99	F HA 2140 00 99	F HA 2150 00 99	-	-
75	F HA 2210 00 99	F HA 2220 00 99	F HA 2230 00 99	F HA 2240 00 99	F HA 2250 00 99	F HA 2260 00 99	F HA 2270 00 99
100-125	F HA 2310 00 99	F HA 2320 00 99	F HA 2330 00 99	F HA 2340 00 99	F HA 2350 00 99	F HA 2360 00 99	F HA 2370 00 99
150-175	F HA 2410 00 99	F HA 2420 00 99	F HA 2430 00 99	F HA 2440 00 99	F HA 2450 00 99	F HA 2460 00 99	F HA 2470 00 99
200-250	F HA 2510 00 99	F HA 2520 00 99	F HA 2530 00 99	F HA 2540 00 99	F HA 2550 00 99	F HA 2560 00 99	F HA 2570 00 99
300-400	-	-	-	F HA 2640 00 99	F HA 2650 00 99	F HA 2660 00 99	F HA 2670 00 99

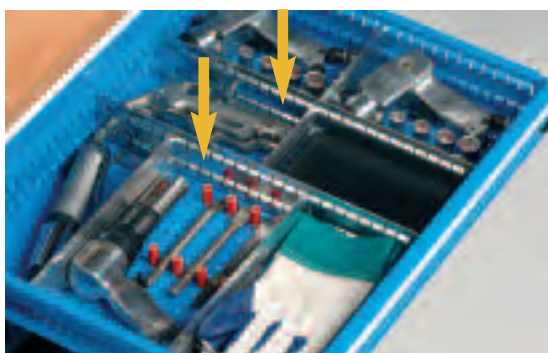

SLOTTED PARTITIONS



FOR FRONT HEIGHTS

	ORD. NO. Lengths 17 Eh (286 mm)	ORD. NO. Lengths 27 Eh (455 mm)	ORD. NO. Lengths 30 Eh (507 mm)	ORD. NO. Lengths 36 Eh (610 mm)	ORD. NO. Lengths 54 Eh (914 mm)	ORD. NO. Lengths 64 Eh (1085 mm)	ORD. NO. Lengths 78 Eh (1323 mm)
50	F HA 1110 00 99	F HA 1120 00 99	F HA 1130 00 99	F HA 1140 00 99	F HA 1150 00 99	-	-
75	-	F HA 1220 00 99	F HA 1230 00 99	F HA 1240 00 99	F HA 1250 00 99	F HA 1260 00 99	F HA 1270 00 99
100-125	-	F HA 1320 00 99	F HA 1330 00 99	F HA 1340 00 99	F HA 1350 00 99	F HA 1360 00 99	F HA 1370 00 99
150-175	-	F HA 1420 00 99	F HA 1430 00 99	F HA 1440 00 99	F HA 1450 00 99	F HA 1460 00 99	F HA 1470 00 99
200-250	-	F HA 1520 00 99	-	F HA 1540 00 99	F HA 1550 00 99	F HA 1560 00 99	F HA 1570 00 99
300-400	-	F HA 1620 00 99	-	F HA 1640 00 99	F HA 1650 00 99	F HA 1660 00 99	F HA 1670 00 99



SINGLE-SIDED SLOTTED PARTITIONS



FOR FRONT HEIGHTS

	ORD. NO. Lengths 27 Eh (455 mm)	ORD. NO. Lengths 36 Eh (610 mm)
50	F HA 1121 00 99	F HA 1141 00 99

■ INFO



www.famispa.com

ZINCATO F. 99

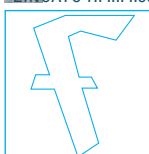

1 EH = 17 mm

SERIES STANDARD H

PLAIN PARTITIONS

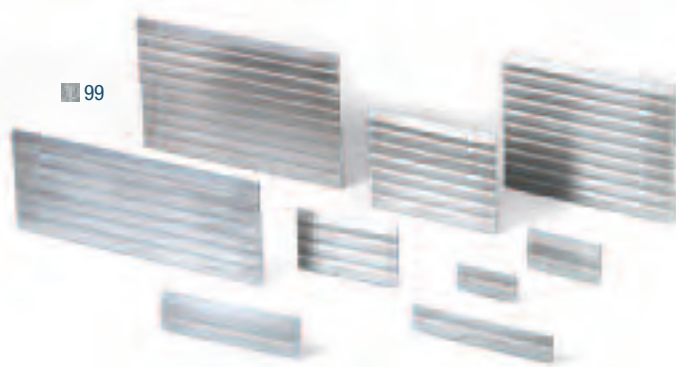

FOR FRONT HEIGHTS

	ORD. NO. Lengths 2 Eh (30 mm)	ORD. NO. Lengths 3 Eh (47 mm)	ORD. NO. Lengths 4 Eh (64 mm)	ORD. NO. Lengths 5 Eh (81 mm)	ORD. NO. Lengths 6 Eh (98 mm)	ORD. NO. Lengths 7 Eh (115 mm)
50	F HA 3105 00 00	F HA 3110 00 00	F HA 3115 00 00	F HA 3120 00 00	F HA 3125 00 00	F HA 3130 00 00
75	-	F HA 3210 00 00	F HA 3215 00 00	F HA 3220 00 00	F HA 3225 00 00	F HA 3230 00 00
100-125	-	F HA 3310 00 00	F HA 3315 00 00	F HA 3320 00 00	F HA 3325 00 00	F HA 3330 00 00
150-175	-	-	-	-	F HA 3425 00 00	F HA 3430 00 00
200-250	-	-	-	-	-	F HA 3530 00 00
300-400	-	-	-	-	-	-

FOR FRONT HEIGHTS

	ORD. NO. Lengths 8 Eh (132 mm)	ORD. NO. Lengths 9 Eh (149 mm)	ORD. NO. Lengths 10 Eh (166 mm)	ORD. NO. Lengths 12 Eh (200 mm)	ORD. NO. Lengths 15 Eh (251 mm)	ORD. NO. Lengths 18 Eh (302 mm)
50	F HA 3135 00 00	F HA 3140 00 00	F HA 3145 00 00	F HA 3150 00 00	F HA 3155 00 00	F HA 3160 00 00
75	F HA 3235 00 00	F HA 3240 00 00	F HA 3245 00 00	F HA 3250 00 00	F HA 3255 00 00	F HA 3260 00 00
100-125	F HA 3335 00 00	F HA 3340 00 00	F HA 3345 00 00	F HA 3350 00 00	F HA 3355 00 00	F HA 3360 00 00
150-175	F HA 3435 00 00	F HA 3440 00 00	F HA 3445 00 00	F HA 3450 00 00	F HA 3455 00 00	F HA 3460 00 00
200-250	F HA 3535 00 00	F HA 3540 00 00	F HA 3545 00 00	F HA 3550 00 00	F HA 3555 00 00	F HA 3560 00 00
300-400	-	F HA 3640 00 00	F HA 3645 00 00	F HA 3650 00 00	F HA 3655 00 00	F HA 3660 00 00

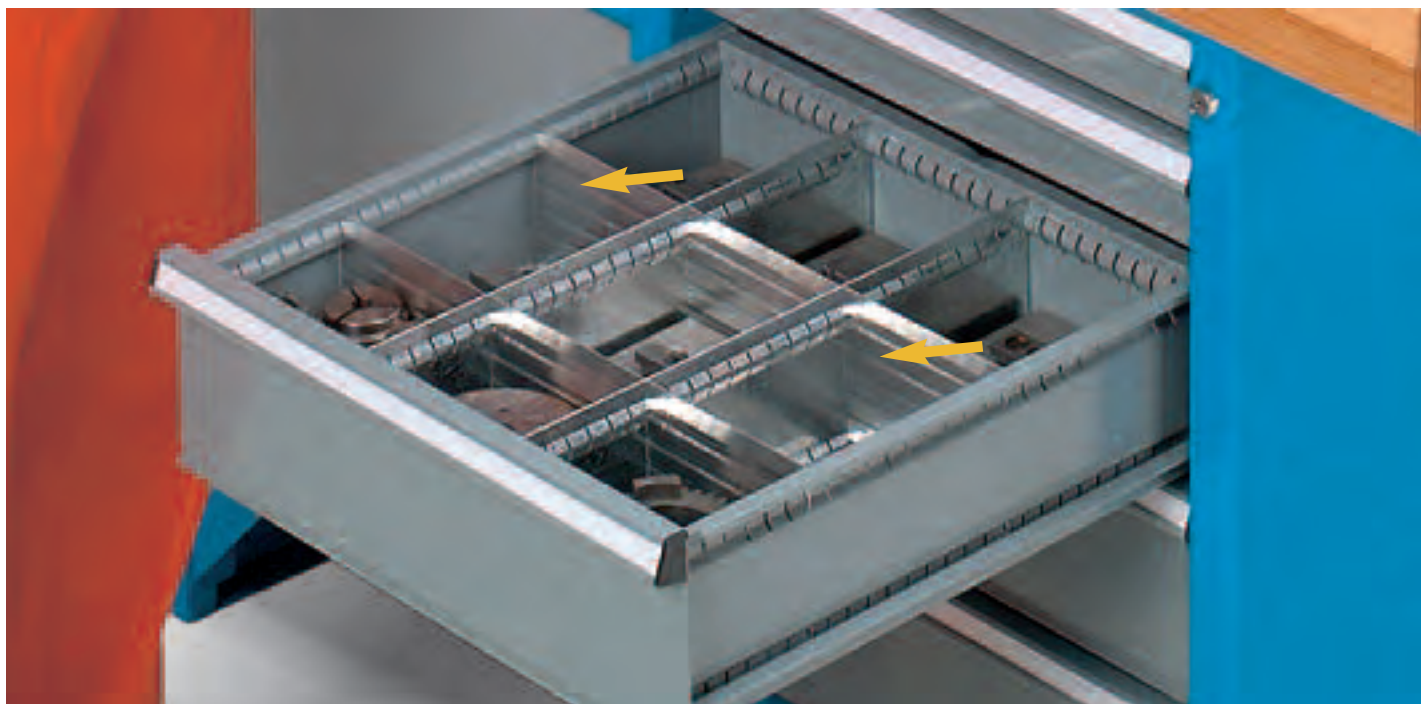

ZINCATO F.99

INFO ■

www.famispa.com



1 EH = 17 mm

SERIES STANDARD H

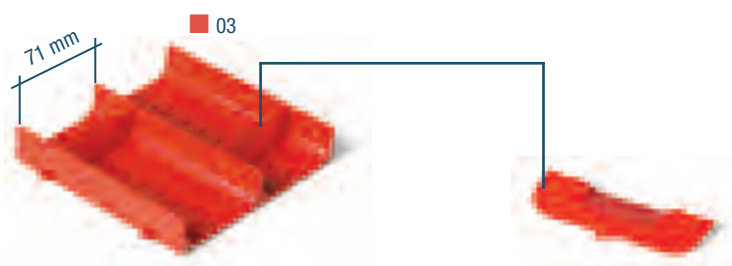

SERIES STANDARD H

TROUGH

Trough with 2 grooves **9x9 Eh** Dimensions mm**ORD. NO. F HC 3071 00 03** 150x150x28 hFor tools \varnothing max. 70 mm

Trough divider 73 mm

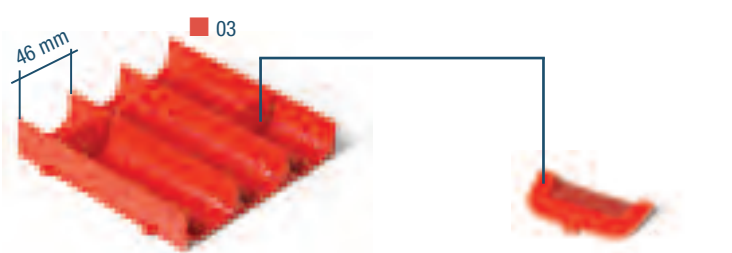
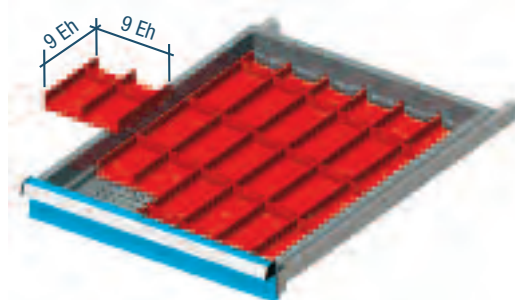
ORD. NO. F HC 1871 00 03Trough with 3 grooves **9x9 Eh** Dimensions mm**ORD. NO. F HC 3471 00 03** 150x150x28 hFor tools \varnothing max. 45 mm

Trough divider 47 mm

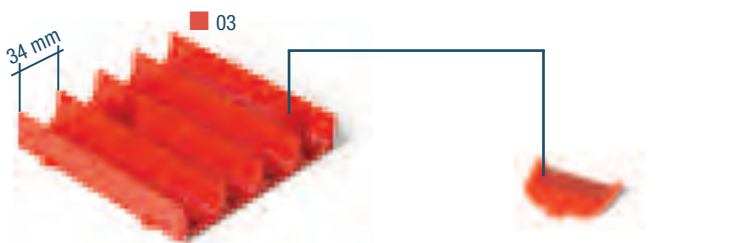
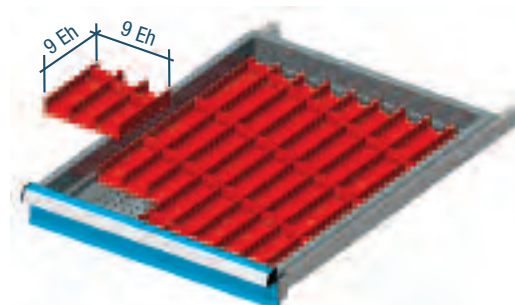
ORD. NO. F HC 1471 00 03Trough with 4 grooves **9x9 Eh** Dimensions mm**ORD. NO. F HC 3871 00 03** 150x150x28 hFor tools \varnothing max. 33 mm

Trough divider 36 mm

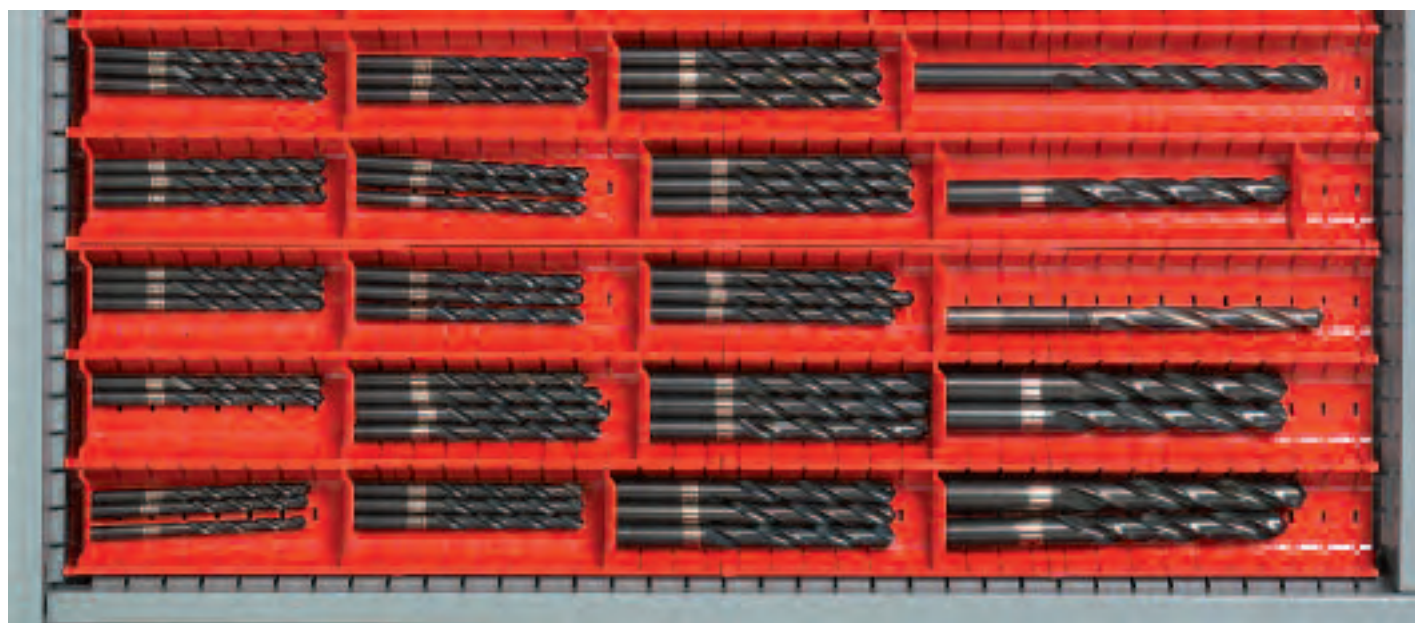
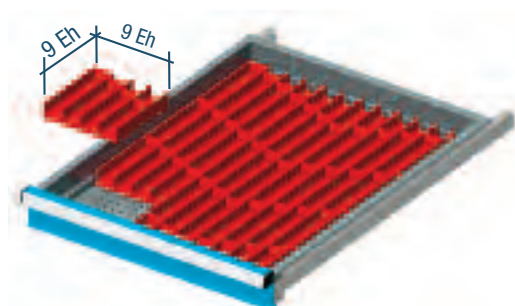
ORD. NO. F HC 1071 00 03

1 EH = 17 mm

SERIES STANDARD H

PLASTIC BOXES

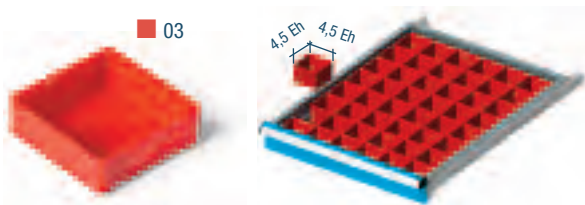

FOR FRONT HEIGHTS

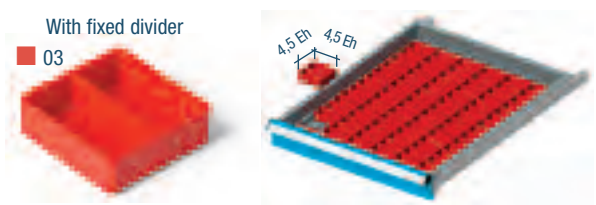
ORD. NO. Plastic boxes
4,5x4,5 EhDimensions
mm50
75F HC 4471 00 03
F HC 6071 00 0375x75x26 h
75x75x52 h

With fixed divider

03

FOR FRONT HEIGHTS

ORD. NO. Plastic boxes
4,5x4,5 EhDimensions
mm

50

F HC 4071 00 03

75x75x26 h

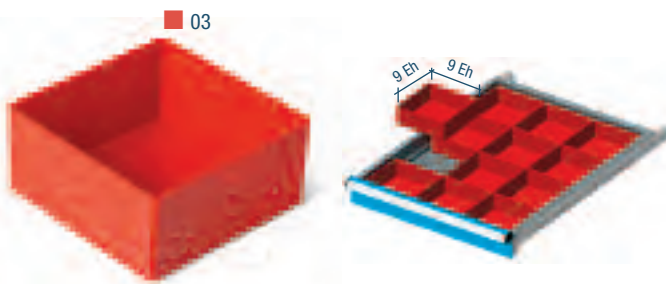

FOR FRONT HEIGHTS

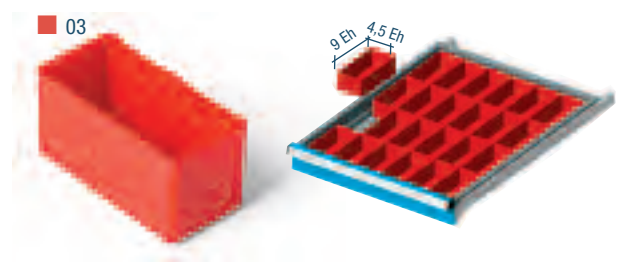
ORD. NO. Plastic boxes
9x9 EhDimensions
mm50
75
100-125F HC 5271 00 03
F HC 6871 00 03
F HC 7671 00 03150x150x26 h
150x150x52 h
150x150x71 h

FOR FRONT HEIGHTS

ORD. NO. Plastic boxes
9x4,5 EhDimensions
mm50
75
100-125F HC 4871 00 03
F HC 6471 00 03
F HC 7271 00 03150x75x26 h
150x75x52 h
150x75x71 h

Divider for boxes F HC 5671

ORD. NO. F HC 8071 00 03

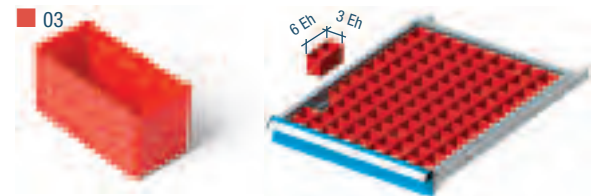
Example of use of the
central divider

FOR FRONT HEIGHTS

ORD. NO. Plastic boxes
6x3 EhDimensions
mm

75

F HC 5671 00 03

100x50x52 h

LABEL HOLDER

Label holder including plastic cover + labels

ORD. NO. F HC 9071 00 03

Not suitable for F HC 5671 00 03

Additional labels including plastic covers

ORD. NO. R FHD 0002 00

Package of: 84 pz

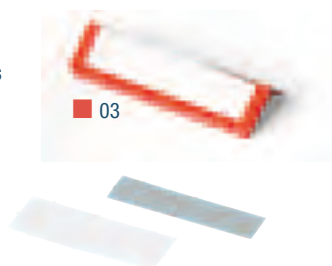

INFO



www.famisp.com

RED F. 03

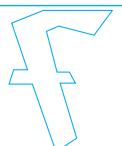

SERIES STANDARD H

CUTTER HOLDERS



■ 03

Tool identification label pin Ø 3 mm 26 mm h

ORD. NO. F HD 0250 00 99

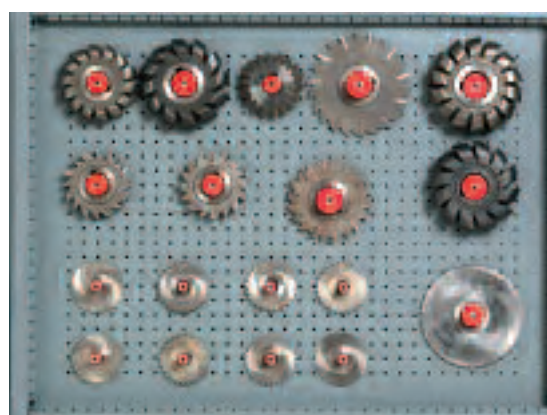
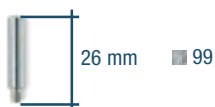

ORD. NO. CUTTER HOLDERS	Cutter holders Ø mm	Hole DIN Tool mm	Height mm
F HD 2071 00 03	12,2	13	26
F HD 2371 00 03	15,5	16	26
F HD 2671 00 03	21,5	22	26
F HD 2971 00 03	26,5	27	26
F HD 3271 00 03	31,2	32	26
F HD 3571 00 03	39,5	40	26
F HD 3871 00 03	49,5	50	26
F HD 4171 00 03	1	-	26
F HD 4471 00 03	1½	-	26

TOOL IDENTIFICATION LABEL BOXES

Label boxes dim. mm 65x25x30 h

ORD. NO. F HD 8271 00 03

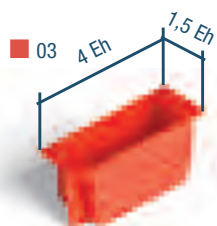

The tool identification label containers must be combined with the following slotted partitions:

ORD. NO. F HA 1140 00 99 for 600 mm long drawers (36 Eh)

ORD. NO. F HA 1120 00 99 for 447 mm long drawers (27 Eh)

RED F. 03 GALVANISED F. 99

INFO ■

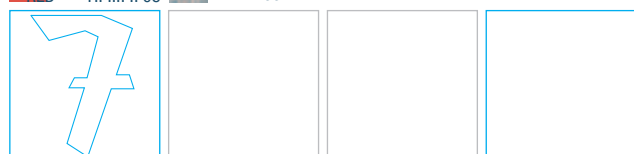

1 EH = 17 mm

SERIES STANDARD H

ANGLE-GROOVED TRAYS



PLAIN PARTITION WIDTH 9 EH

ORD. NO. F HA 3140 00 00 This partition must be combined with the following slotted partitions:

ORD. NO. F HA 1140 00 99 for long drawers 600 mm (36 Eh)

ORD. NO. F HA 1120 00 99 for long drawers 447 mm (27 Eh)

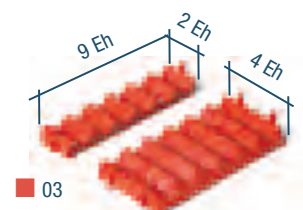

03

Angle tray with 6 grooves for tools max. Ø 20 mm

ORD. NO. F HD 1871 00 03

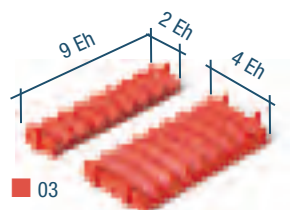

03

Angle tray with 8 grooves for tools max. Ø 14 mm

ORD. NO. F HD 1471 00 03

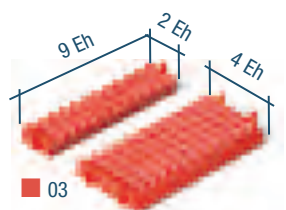

03

Angle tray with 11 grooves for tools max. Ø 8 mm

ORD. NO. F HD 1071 00 03

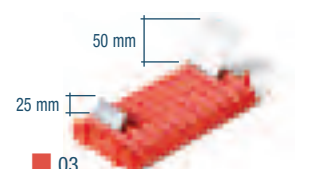

03

FOR FRONT HEIGHTS

ORD. NO. Label holders

H mm

50
75-100

F HD 0105 00 00
F HD 0110 00 00

25
50

ALLEN KEY TRAY

ORD. NO.

F HD 9271 00 03

Dimensions mm

150x150x26 h

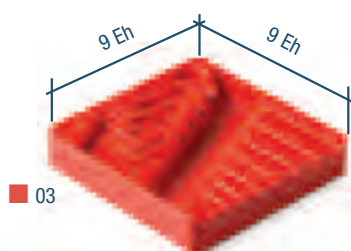

03

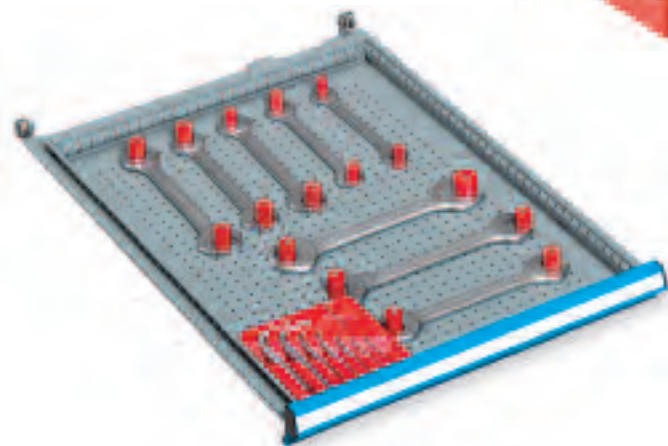

INFO

GALVANISED
F. 99

RED
F. 03



www.famispa.com

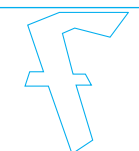

SERIES STANDARD H

PAIR OF ARBOR HOLDERS

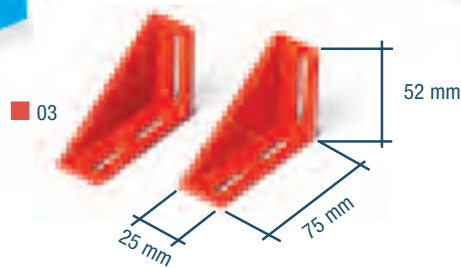
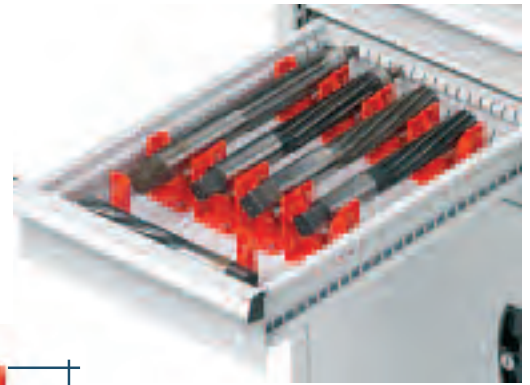
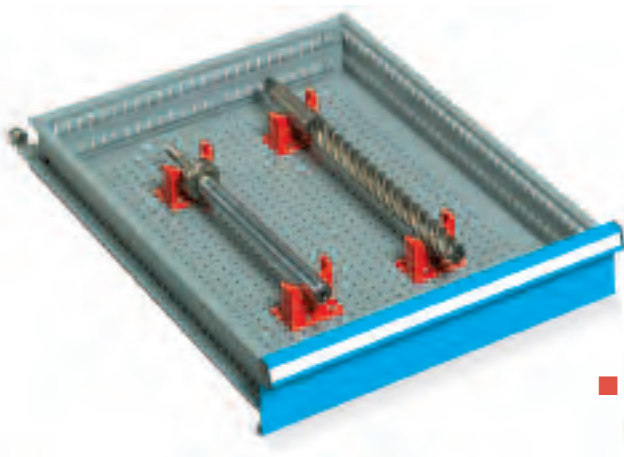

Pair of arbor holders

ORD. NO. F HD 5071 00 03

MULTI-PURPOSE SUPPORTS

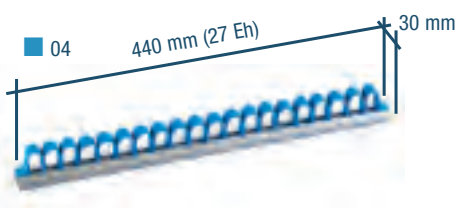

Multi-purpose supports

ORD. NO. F HD 7271 00 04

Dimensions mm

440x30x35 h

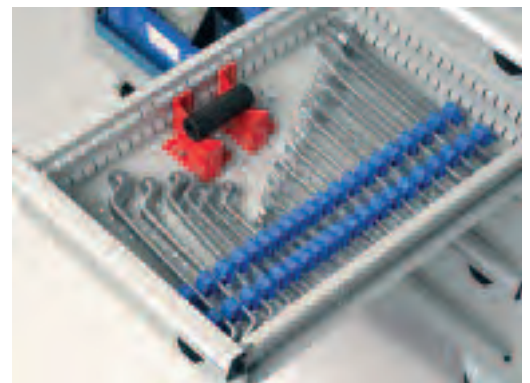

MULTI-PURPOSE SUPPORTS

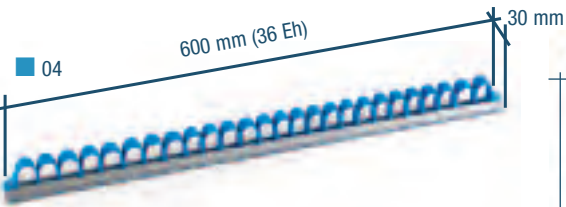

Multi-purpose supports

ORD. NO. F HD 7571 00 04

Dimensions mm

600x30x35 h

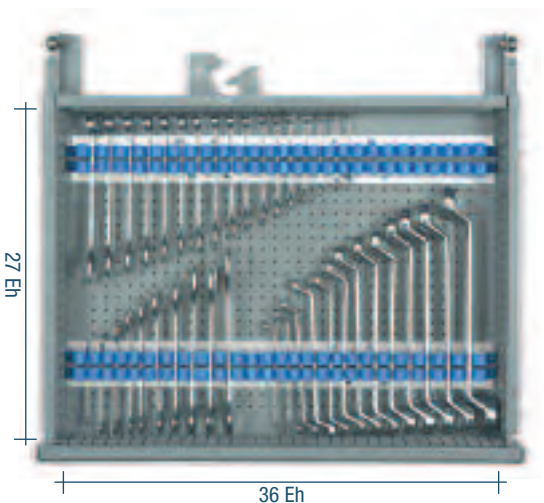
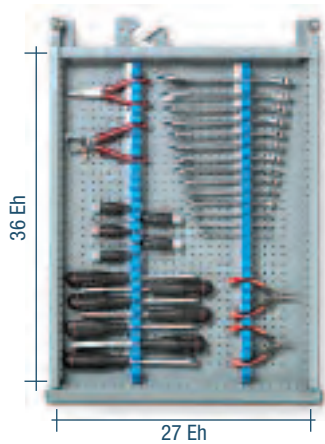

RED F. 03 BLUE F. 04

INFO ■

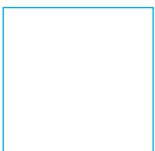
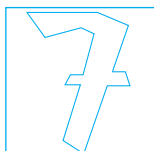

www.famispa.com

1 EH = 17 mm

SERIES STANDARD H

LOCATION PINS

■ 99  27 mm

FOR FRONT HEIGHTS **ORD. NO.** Location pins Ø 6 mm
27 mm h

50 **F HD 0210 00 99**

■ 99  52 mm

FOR FRONT HEIGHTS **ORD. NO.** Location pins Ø 6 mm
52 mm h

75 **F HD 0215 00 99**

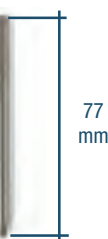
■ 99  77 mm

FOR FRONT HEIGHTS **ORD. NO.** Location pins Ø 6 mm
77 mm h

100-125 **F HD 0220 00 99**



SLIDING SHELF



Sliding shelf Dimensions mm

ORD. NO. F HD 0310 00 99 470x200x30 h

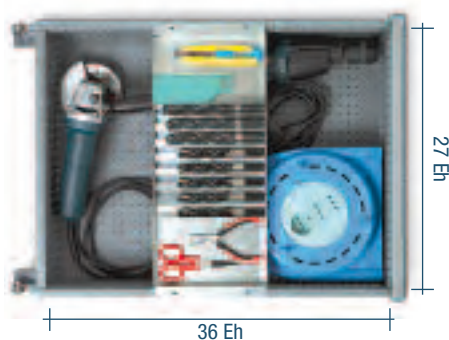
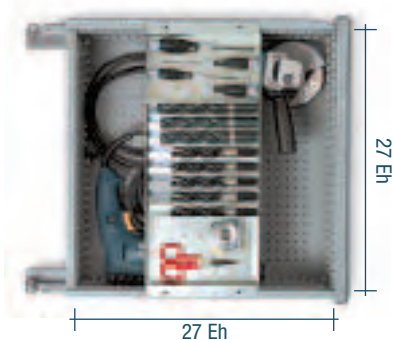

■ Only for width 447 mm (27 Eh)

■ INFO



www.famispaspa.com

GALVANISED
F... ..99

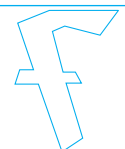

SERIES STANDARD H

FOAM BASE FOR DRAWERS

FOR DRAWERS	ORD. NO. Foam base for drawers	Dimensions mm
54x27 Eh	F HD 6171 00 00	905x450x10 h
54x36 Eh	F HD 6471 00 00	905x600x10 h
27x27 Eh	F HD 5471 00 00	450x450x10 h
36x27 Eh	F HD 5571 00 00	605x450x10 h
36x36 Eh	F HD 5871 00 00	605x605x10 h



NON-SLIP RUBBER

FOR DRAWERS	ORD. NO. Non-slip rubber	Dimensions mm
19x27 Eh	F HD 6505 00 07	323x450x3 h
27x27 Eh	F HD 6510 00 07	450x450x3 h
36x27 Eh	F HD 6515 00 07	600x450x3 h
54x27 Eh	F HD 6525 00 07	905x450x3 h
27x36 Eh	F HD 6560 00 07	450x600x3 h
36x36 Eh	F HD 6565 00 07	600x600x3 h
45x36 Eh	F HD 6570 00 07	758x600x3 h
54x36 Eh	F HD 6575 00 07	905x600x3 h
64x36 Eh	F HD 6580 00 07	1081x600x3 h
78x36 Eh	F HD 6585 00 07	1319x600x3 h



ROLL

FOR DEPTH	ORD. NO. Non-slip rubber	Dimensions mm
27 Eh	CMV 99 201	10.000x450x3 h
36 Eh	CMV 99 202	10.000x600x3 h



PAIR OF GUIDE RAILS FOR SUSPENSION FOLDERS

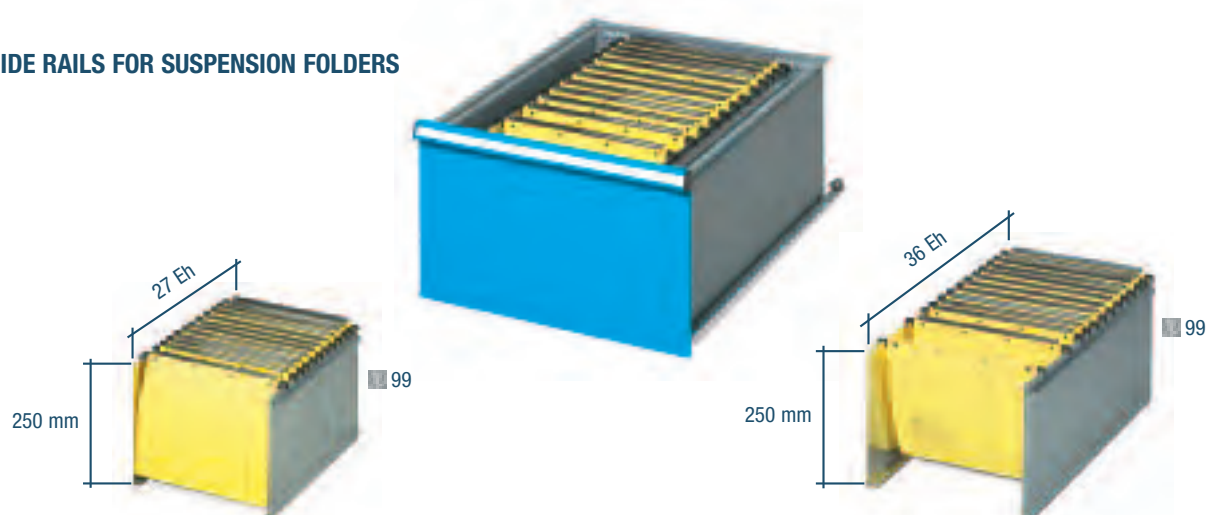

FRONT HEIGHT	ORD. NO. Pair of guide	For drawer depth
300	F HD 0460 00 99	27 Eh

FRONT HEIGHT	ORD. NO. Pair of guide	For drawer depth
300	F HD 0465 00 99	36 Eh

GALVANISED
F.99

INFO ■



1 EH = 17 mm

SERIES STANDARD H

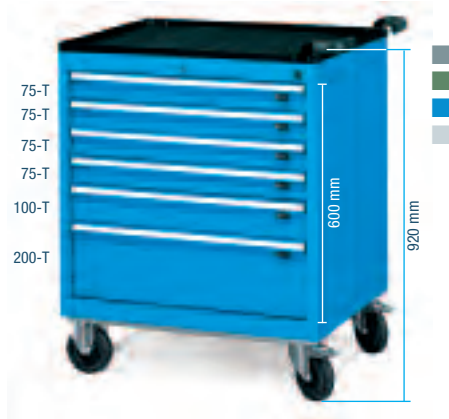

CABINET

ORD. NO.

DRAWERS

F DF B560 03 04

6

Cabinet with 6 full extension drawers

Ø 125 mm standard rubber wheels

Cabinet load capacity: 225 kg

Dimensions mm 792x600x920 h

Central lock

PARTITIONING MATERIAL SET FOR 6 DRAWERS 36x27 EH

ORD. NO.

F FH 9907 01 00

Capacity of up to 170 tools

This set is suitable for the ORD. NO. F DF B560 03.. cabinet set (see above)

The drawers and tools are not included in this set

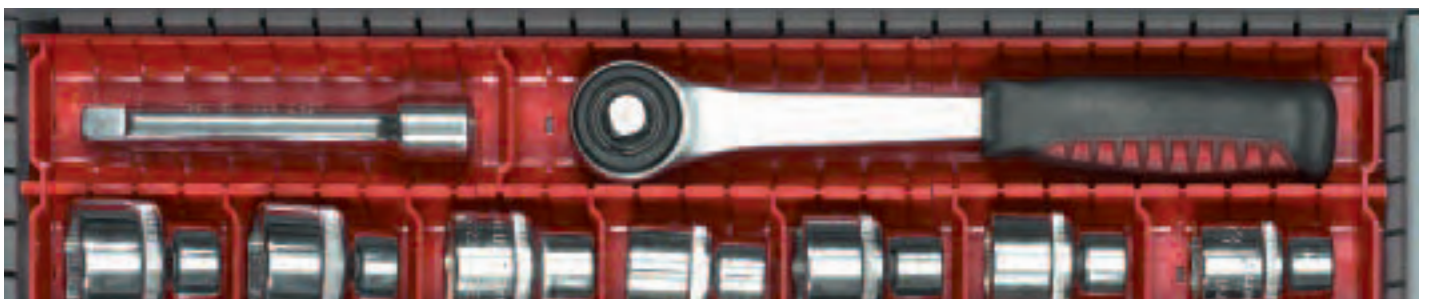
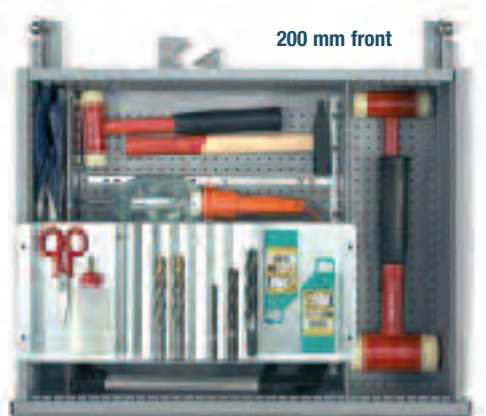
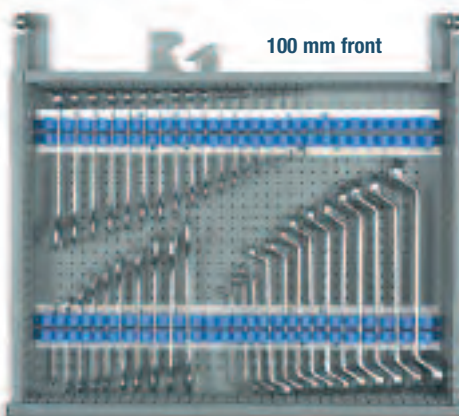
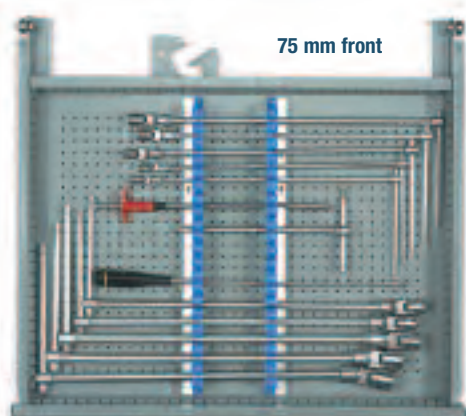
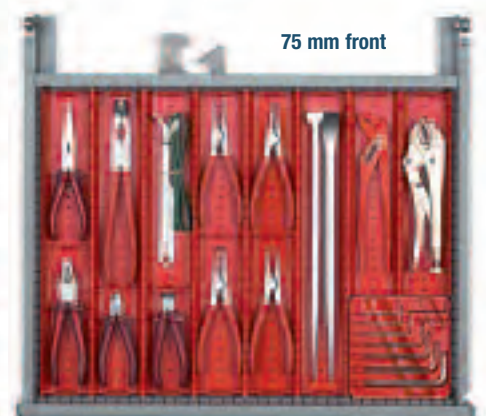
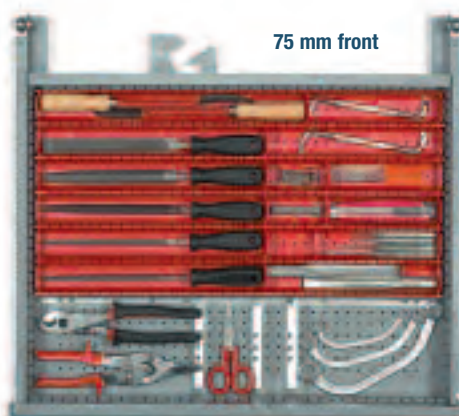
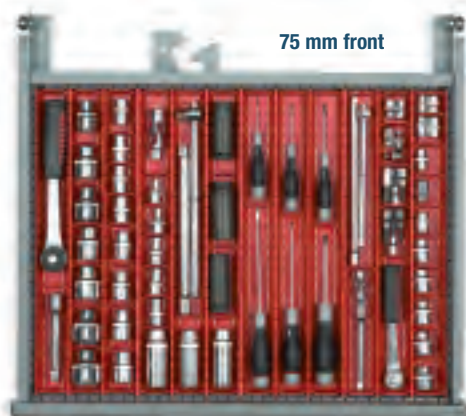

ORGANIZE SPACE

LET'S REORG

- STORAGE CUPBOARDS SERIES PERFORM
- SLIDING DOOR CABINETS SERIES PERFORM
- CONTAINER CABINETS SERIES PERFORM
- LOCKERS SERIES PERFORM

VERSATILE

NORMAL AND FULL EXTENSION DRAWERS

SEVERAL ACCESSORIES SERIES

STRONG AND RELIABLE





ORGANIZE SPACE

LET'S REORG

CABINETS SERIES PERFORM A110

LENGTH = 512 mm DEPTH = 555 mm (24x27 Eh)



ORD. NO. F AA 1100 04 08
RAL 7035



ORD. NO. F AA 0110 01 08
RAL 7035

24 EH (396 mm)



27 EH (447 mm)

FLOOR FIXING SET



2x

- 2 "HILTI" plugs for concrete floors \geq to classes B25/RBK250/MP_A 25 N/mm²
- Recommended traction of the plug: 2.9 KN
- Plug diameter: \varnothing 6 mm

ORD. NO. F AG 9204 00 99

CABINET

ORD. NO.

F AA 1100 04 08

Dimensions mm 512x555x1000 h

Tools excluded

CABINET WITH WRITING DESK

ORD. NO.

F AA 0110 01 08

Dimensions mm 512x555x1270 h

RAL 7000 F.01

RAL 6011 F.02

RAL 5012 F.04

RAL 7035 F.08

SUPPLEMENTARY PARTS ■

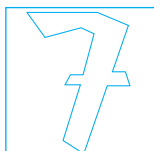

- **Spare key.** Always indicate the number on the cylinder lock of the key to be replaced.

ORD. NO. R CSC 0002 00

- **Master key.** This type of key opens all the 45 and 46 series locks.

ORD. NO. R CSC 0001 00



LENGTH = 512 mm DEPTH = 555 mm (24x27 Eh)

CABINETS SERIES PERFORM A110



■ Top shelf load capacity 80 kg

ORD. NO.	SHELVES
F AA 1100 51 04	2
Cabinet with 2 shelves depth 500 mm load capacity 100 kg	
Cabinet load capacity: 250 kg	
Dimensions mm 512x555x1000 h	



ORD. NO.	DRAWERS
F AA 1100 53 04	1
Cabinet with 2 shelves depth 500 mm load capacity 100 kg	
1 normal extension drawer load capacity 50 kg	
Cabinet load capacity: 250 kg	
Dimensions mm 512x555x1000 h	



ORD. NO.	DRAWERS
F AA 1100 54 04	2
Cabinet with 1 shelf depth 500 mm load capacity 100 kg	
2 normal extension drawers load capacity 50 kg	
Cabinet load capacity: 250 kg	
Dimensions mm 512x555x1000 h	



ORD. NO.	DRAWERS
F AA 1100 56 04	3
Cabinet with 1 shelf depth 500 mm load capacity 100 kg	
3 normal extension drawers load capacity 50 kg	
Cabinet load capacity: 250 kg	
Dimensions mm 512x555x1000 h	



ORD. NO.	DRAWERS
F AA 0110 01 04	1
Cabinet with 1 shelf depth 500 mm load capacity 100 kg	
1 writing desk top with normal extension drawer load capacity 50 kg	
Cabinet load capacity: 250 kg	
Dimensions mm 512x555x1270 h	

■ KEY



- Normal extension (87%)
- If the cabinet is with drawers it must be fixed to the floor or to the wall
- All indicated loads are net and refer to evenly distributed weights

RAL 7000 F.01 RAL 6011 F.02 RAL 5012 F.04 RAL 7035 F.08

■ Partitioning material see page A224-A225

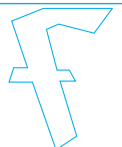

CABINETS SERIES PERFORM A110

LENGTH = 512 mm DEPTH = 555 mm (24x27 Eh)

EMPTY CABINET WITH DOOR

■ 01
■ 02
■ 04
■ 08



■ If one or more drawers are fitted, the cabinets must be fixed to the floor or to the wall. If the cabinets are placed one on the top of the other, they must be fixed to the wall.



■ The drawers in the cabinet have a maximum load capacity of 200 kg regardless of the load capacity of the cabinets.

ORD. NO.

F AA 1100 00 04

Cabinet load capacity: 250 kg

Dimensions mm 512x555x1000 h

Internal dimensions mm 480x500x850 h

The F AA 1100 series cabinets are supplied as standard with 2 floor fixing brackets and 2 wall fixing brackets.

ADJUSTABLE SHELF DEPTH 500 mm

■ 99

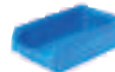
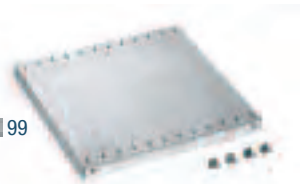

size 4A2



size 4



size 4A5

■ Containers see page G28-G30

ORD. NO.

F AC 2100 01 99

Complete with 4 hooks

Load capacity: 100 kg

The depth of this shelf is suitable for the following containers: size 4A2 / size 4 / size 4A5

Dimensions mm 483x500x35 h

NORMAL EXTENSION DRAWERS 24x27 EH

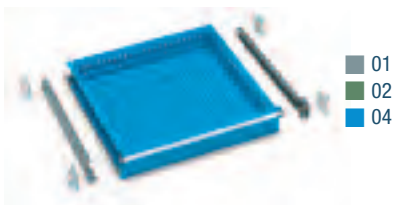

■ 01
■ 02
■ 04

TELESCOPIC EXTENSION DRAWERS 24x27 EH



■ 01
■ 02
■ 04

ORD. NO.

F AC 1100 00 04

Normal extension drawer load capacity: 50 kg

Internal dimensions mm 396x447x85 h

ORD. NO.

F AC 1150 00 04

Full extension drawer load capacity: 100 kg

Internal dimensions mm 396x447x85 h

RAL 7000 F.01

RAL 6011 F.02

RAL 5012 F.04

RAL 7035 F.08

KEY ■

■ Partitioning material see page A224-A225

- Normal extension (87%)
- Full telescopic extension (100%)
- If the cabinet is with drawers it must be fixed to the floor or to the wall
- All indicated loads are net and refer to evenly distributed weights



LENGTH = 512 mm DEPTH = 555 mm (24x27 Eh)

CABINETS SERIES PERFORM A110

TOP SHELF WITH 3 EDGES

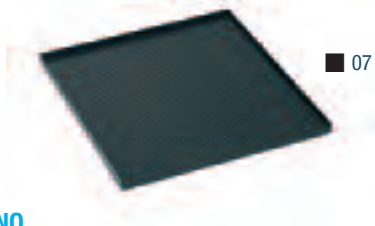

ORD. NO.

F AC 4100 01 07

For cabinet F AA 1100 ...

Dimensions mm 512x555x20 h



Oil-resistant rubber mat

UPPER MDF TOP WITH RUBBER OR PVC COVERING DIMENSIONS 512x555x31,5 mm H

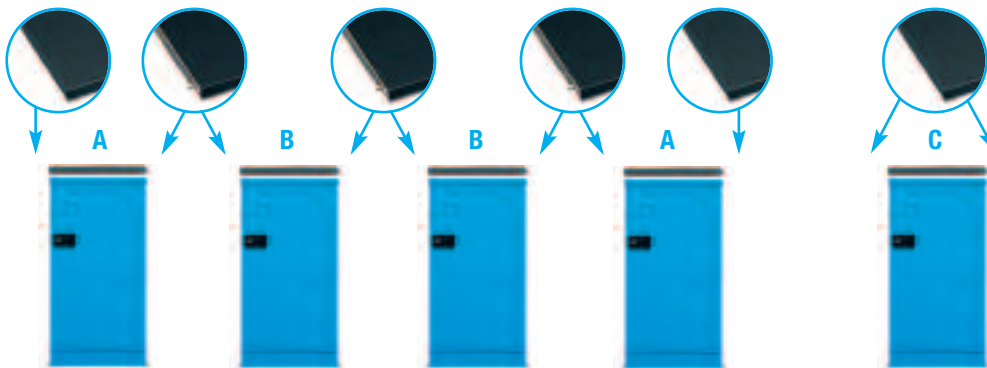

ORD. NO. **F UZ 9999 00 00**

Perforation of the cabinet top shelf for MDF top fixing.



Detail of the oil-resistant rubber



07

A

ORD. NO.

F UZ 3050 12 07

MDF top with rubber covering

No side profile

For additional central cabinets

Oil-resistant rubber mat



07

B

ORD. NO.

F UZ 3050 13 07

MDF top with rubber covering

2 side profiles

For single cabinet

Oil-resistant rubber mat



07

C

ORD. NO.

F UZ 3050 11 07

MDF top with rubber covering

Side profile

For end cabinets

Oil-resistant rubber mat

INFO

RAI 9011 F.07



www.famispa.com

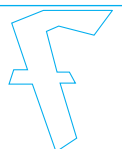

CABINETS SERIES PERFORM A120

LENGTH = 1023 mm DEPTH = 555 mm (24/54x27 Eh)



ORD. NO. F AA 1200 S1 01
RAL 7000

ORD. NO. F AA 1200 01 04
RAL 5012

54 EH (906 mm)

24 EH (396 mm)

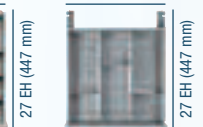
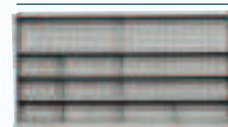

FLOOR FIXING SET



2x

- 2 "HILTI" plugs for concrete floors \geq to classes B25/RBK250/MP_A 25 N/mm²
- Recommended traction of the plug: 2.9 KN
- Plug diameter: \varnothing 6 mm

ORD. NO. F AG 9204 00 99

CABINET

ORD. NO.

F AA 1200 S1 01

1 normal extension drawer, 3 adjustable shelves,
3 vertical partitions, 3 shelf dividers, 1 size 4 container,
5 Multibox containers with safety rods, 6 guides for
Multibox, 1 top shelf with oil-resistant rubber mat.

Dim. mm 1023x555x1000 h

Tools and drawer layout set excluded

CABINET

ORD. NO.

F AA 1200 01 04

1 F AA 1200 51 04 cabinet complete with
2 adjustable shelves

1 F AC 4200 01 07 top shelf with
oil-resistant rubber mat

Dimensions mm 1023x555x1000 h

Tools excluded

RAL 7000 F.01

RAL 6011 F.02

RAL 5012 F.04

RAL 7035 F.08

SUPPLEMENTARY PARTS ■

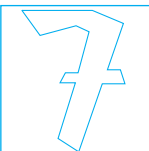

- **Spare key.** Always indicate the number on the cylinder lock of the key to be replaced.

ORD. NO. R CSC 0002 00

- **Master key.** This type of key opens all the 45 and 46 series locks.

ORD. NO. R CSC 0001 00



LENGTH = 1023 mm DEPTH = 555 mm (24/54x27 Eh)

CABINETS SERIES PERFORM A120



■ Top shelf load capacity 80 kg

ORD. NO.	SHELVES
F AA 1200 51 04	2
Cabinet with 2 shelves depth 500 mm load capacity 100 kg	
Cabinet load capacity: 600 kg	
Dimensions mm 1023x555x1000 h	



ORD. NO.	DRAWERS
F AA 1200 52 04	2
Cabinet with 2 shelves depth 500 mm load capacity 100 kg	
1 pair of normal extension drawers load capacity 50 kg	
Cabinet load capacity: 600 kg	
Dimensions mm 1023x555x1000 h	



ORD. NO.	DRAWERS
F AA 1200 53 04	3
Cabinet with 1 shelf depth 500 mm load capacity 100 kg	
1 normal extension drawer load capacity 50 kg	
1 pair of normal extension drawers load capacity 50 kg	
Cabinet load capacity: 600 kg	
Dimensions mm 1023x555x1000 h	



ORD. NO.	DRAWERS
F AA 1200 54 04	4
Cabinet with 1 shelf depth 500 mm load capacity 100 kg	
2 pairs of normal extension drawers load capacity 50 kg	
Cabinet load capacity: 600 kg	
Dimensions mm 1023x555x1000 h	



ORD. NO.	DRAWERS
F AA 1200 55 04	2
Cabinet with 1 shelf depth 500 mm load capacity 100 kg	
2 normal extension drawers load capacity 50 kg	
Cabinet load capacity: 600 kg	
Dimensions mm 1023x555x1000 h	

■ KEY

RAL 7000 F.01 RAL 6011 F.02 RAL 5012 F.04 RAL 7035 F.08

■ Partitioning material see page A224-A225



- Normal extension (87%)
- If the cabinet is with drawers it must be fixed to the floor or to the wall
- All indicated loads are net and refer to evenly distributed weights

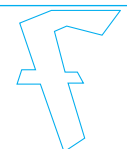

CABINETS SERIES PERFORM A120

EMPTY CABINET WITH DOOR



■ If one or more drawers are fitted, the cabinets must be fixed to the floor or to the wall. If the cabinets are placed one on the top of the other, they must be fixed to the wall.

■ The drawers in the cabinet have a maximum load capacity of 350 kg regardless of the load capacity of the cabinets.

ORD. NO.

F AA 1200 00 04

Cabinet load capacity: 600 kg

Dimensions mm 1023x555x1000 h

Internal dimensions mm 990x500x850 h

The F AA 1200 series cabinets are supplied as standard with 2 floor fixing brackets, 2 wall fixing brackets and 2 levelling devices.

ADJUSTABLE SHELF DEPTH 500 mm

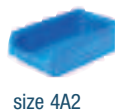

■ Containers see page G28-G30

ORD. NO.

STRENGTHENING BAR

LOAD CAPACITY kg

F AC 2500 01 99

0

100

F AC 2500 03 99

1

180

Complete with 4 hooks

The depth of this shelf is suitable for the following containers: size 4A2 / size 4 / size 4A5

Dimensions mm 995x500x35 h

PAIR OF NORMAL AND TELESCOPIC EXTENSION DRAWERS 24x27 EH

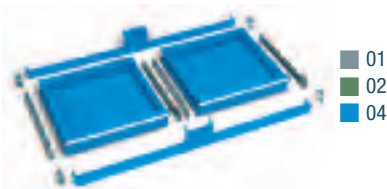

NORMAL AND TELESCOPIC EXTENSION DRAWERS 54x27 EH



ORD. NO.

EXTENSION

F AC 1600 00 04

NORMAL

F AC 1650 00 04

TELESCOPIC

Normal extension drawer load capacity: 50 kg

Full extension drawer load capacity: 60 kg

Internal dimensions mm 396x447x85 h (each drawer)

ORD. NO.

EXTENSION

F AC 1200 00 04

NORMAL

F AC 1250 00 04

TELESCOPIC

Normal extension drawer load capacity: 50 kg

Full extension drawer load capacity: 100 kg

Internal dimensions mm 906x447x85 h

RAL 7000 F.01 RAL 6011 F.02 RAL 5012 F.04 RAL 7035 F.08

KEY ■

- Partitioning material see page A224-A225
- Normal extension (87%)
- Full telescopic extension (100%)
- If the cabinet is with drawers it must be fixed to the floor or to the wall
- All indicated loads are net and refer to evenly distributed weights

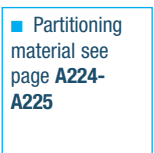
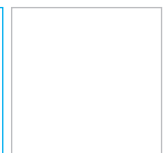
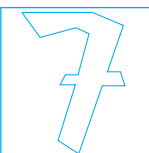

LENGTH = 1023 mm DEPTH = 555 mm (24/54x27 Eh)

CABINETS SERIES PERFORM A120

TELESCOPIC EXTENSION SUSPENSION FOLDER FRAME FOR SUSPENSION FOLDER DIN A4

ORD. NO.

F AC 7500 00 07

The suspension folder frames are supplied with telescopic extension guide rails (100% extension) with 30 kg load capacity.

Overall dimensions: 990x500 mm

For suspension folders DIN A4



■ 07

TOP SHELF WITH 3 EDGES



■ 07



■ Oil-resistant rubber mat

ORD. NO.

F AC 4200 01 07

For cabinet F AA 1200 ...

Dimensions mm 1023x555x20 h

UPPER MDF TOP WITH RUBBER OR PVC COVERING DIMENSIONS 1023x555x31,5 mm H

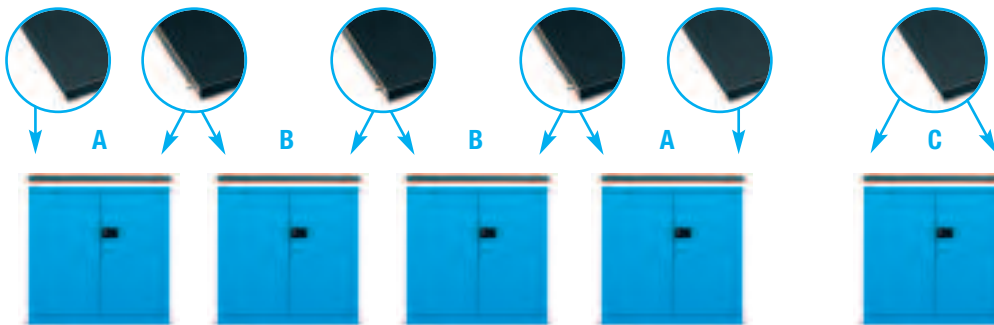

ORD. NO. F UZ 9999 00 00

Perforation of the cabinet top shelf for MDF top fixing.



Detail of the oil-resistant rubber

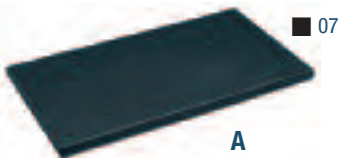

A

■ 07



B

■ 07

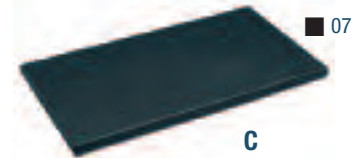

C

■ 07

ORD. NO.

F UZ 3060 11 07

MDF top with rubber covering

Side profile

For end cabinets

Oil-resistant rubber mat

ORD. NO.

F UZ 3060 12 07

MDF top with rubber covering

No side profile

For additional central cabinets

Oil-resistant rubber mat

ORD. NO.

F UZ 3060 13 07

MDF top with rubber covering

2 side profiles

For single cabinet

Oil-resistant rubber mat

■ INFO



www.famispa.com

RAI 9011 F. 07

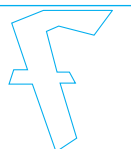

CABINETS SERIES PERFORM A140

LENGTH = 1194 mm DEPTH = 555 mm (24/64x27 Eh)



ORD. NO. F AA 1500 01 08
RAL 7035



ORD. NO. F AA 1500 S2 04
RAL 5012

64 EH (1076 mm)

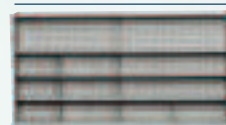

27 EH (447 mm)

24 EH (396 mm)



27 EH (447 mm)

FLOOR FIXING SET



2x

- 2 "HILTI" plugs for concrete floors \geq to classes B25/RBK250/MP_A 25 N/mm²
- Recommended traction of the plug: 2.9 KN
- Plug diameter: \varnothing 6 mm

ORD. NO. F AG 9204 00 99

CABINET

ORD. NO.

F AA 1500 01 08

- 1 F AA 1500 51 08 cabinet complete with
- 2 adjustable shelves
- 1 F AC 4300 01 07 top shelf with oil resistant rubber mat

Dimensions mm 1194x555x1000 h

Tools excluded

CABINET

ORD. NO.

F AA 1500 S2 04

- 1 pair of normal extension drawers
- 3 adjust. shelves, 3 vertical partitions, 3 shelf dividers
- 7 Multibox containers with safety rods
- 8 guides for Multibox, 1 size 4 container
- 1 top shelf with oil-resistant rubber mat

Dim. mm 1194x555x1000 h

Tools excluded

RAL 7000 F.01

RAL 6011 F.02

RAL 5012 F.04

RAL 7035 F.08

SUPPLEMENTARY PARTS ■



- **Spare key.** Always indicate the number on the cylinder lock of the key to be replaced.

ORD. NO. R CSC 0002 00

- **Master key.** This type of key opens all the 45 and 46 series locks.

ORD. NO. R CSC 0001 00



LENGTH = 1194 mm DEPTH = 555 mm (24/64x27 Eh)

CABINETS SERIES PERFORM A140



■ Top shelf load capacity 80 kg

ORD. NO.	SHELVES
F AA 1500 51 04	2
Cabinet with 2 shelves depth 500 mm load capacity 100 kg	
Cabinet load capacity: 600 kg	
Dimensions mm 1194x555x1000 h	
Central lock	



ORD. NO.	DRAWERS
F AA 1500 52 04	2
Cabinet with 1 shelf depth 500 mm load capacity 100 kg	
1 pair of normal extension drawers load capacity 50 kg	
Cabinet load capacity: 600 kg	
Dimensions mm 1194x555x1000 h	
Central lock	



ORD. NO.	DRAWERS
F AA 1500 55 04	3
Cabinet with 1 shelf depth 500 mm load capacity 100 kg	
1 normal extension drawer load capacity 50 kg	
1 pair of normal extension drawers load capacity 50 kg	
Cabinet load capacity: 600 kg	
Dimensions mm 1194x555x1000 h	
Central lock	



ORD. NO.	DRAWERS
F AA 1500 56 04	4
Cabinet with 1 shelf depth 500 mm load capacity 100 kg	
2 pairs of normal extension drawers load capacity 50 kg	
Cabinet load capacity: 600 kg	
Dimensions mm 1194x555x1000 h	
Central lock	



ORD. NO.	DRAWERS
F AA 1500 57 04	2
Cabinet with 1 shelf depth 500 mm load capacity 100 kg	
2 normal extension drawers load capacity 50 kg	
Cabinet load capacity: 600 kg	
Dimensions mm 1194x555x1000 h	
Central lock	

■ KEY

RAL 7000 F.01 RAL 6011 F.02 RAL 5012 F.04 RAL 7035 F.08



- Normal extension (87%)
- Full telescopic extension (100%)
- If the cabinet is with drawers it must be fixed to the floor or to the wall
- All indicated loads are net and refer to evenly distributed weights

■ Partitioning material see page A224-A225

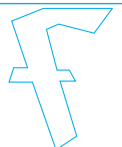

CABINETS SERIES PERFORM A140

EMPTY CABINET WITH DOOR



- 01
- 02
- 04
- 08

■ If one or more drawers are fitted, the cabinets must be fixed to the floor or to the wall. If the cabinets are placed one on the top of the other, they must be fixed to the wall.



■ The drawers in the cabinet have a maximum load capacity of 350 kg regardless of the load capacity of the cabinets.

ORD. NO.

F AA 1500 00 04

Cabinet load capacity: 600 kg

Dimensions mm **1194x555x1000 h**

Internal dimensions mm 1160x500x850 h

The F AA 1500 series cabinets are supplied as standard with 2 floor fixing brackets, 2 wall fixing brackets and 2 levelling devices.

ADJUSTABLE SHELF DEPTH 500 mm

■ 99



size 4A2



size 4

■ Containers see page **G28-G30**



size 4A5

ORD. NO.

STRENGTHENING BAR

LOAD CAPACITY kg

F AC 2550 01 99

0

100

F AC 2550 03 99

1

180

Complete with 4 hooks

The depth of this shelf is suitable for the following containers:
size 4A2 / size 4 / size 4A5

Dimensions mm **1165x500x35 h**

PAIR OF NORMAL AND TELESCOPIC EXTENSION DRAWERS 27x27 EH



- 01
- 02
- 04

ORD. NO.

EXTENSION

F AC 1700 00 04

NORMAL

F AC 1750 00 04

TELESCOPIC

Normal extension drawer load capacity: 50 kg

Full extension drawer load capacity: 60 kg

Internal dimensions mm **447x447x85 h** (each drawer)

NORMAL AND TELESCOPIC EXTENSION DRAWERS 64x27 EH



- 01
- 02
- 04

ORD. NO.

EXTENSION

F AC 1300 00 04

NORMAL

F AC 1350 00 04

TELESCOPIC

Normal extension drawer load capacity: 50 kg

Full extension drawer load capacity: 100 kg

Internal dimensions mm **1076x447x85 h**

RAL 7000 F.01 RAL 6011 F.02 RAL 5012 F.04 RAL 7035 F.08

KEY ■

- Partitioning material see page **A224-A225**
- Normal extension (87%)
- Full telescopic extension (100%)
- If the cabinet is with drawers it must be fixed to the floor or to the wall

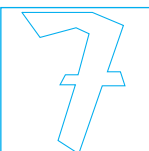

LENGTH = 1194 mm DEPTH = 555 mm (24/64x27 Eh)

CABINETS SERIES PERFORM A140

TOP SHELF WITH 3 EDGES



Oil-resistant rubber mat

ORD. NO.

F AC 4300 01 07

For cabinet F AA 1500 ...

Dimensions mm 1194x555x20 h

UPPER MDF TOP WITH RUBBER OR PVC COVERING DIMENSIONS 1194x555x31,5 mm H

COD. ART F UZ 9999 00 00

Perforation of the cabinet top shelf for MDF top fixing.

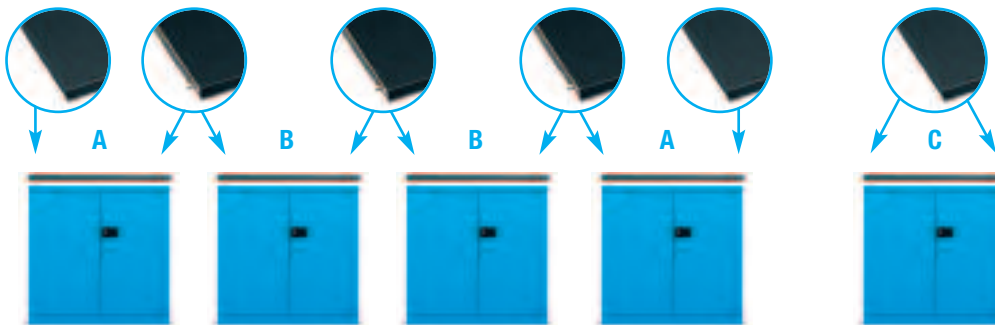

Detail of the oil-resistant rubber



A



B

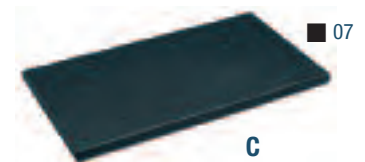

C

ORD. NO.

F UZ 3070 11 07

MDF top with rubber covering

Side profile

For end cabinets

Oil-resistant rubber mat

ORD. NO.

F UZ 3070 12 07

MDF top with rubber covering

No side profile

For additional central cabinets

Oil-resistant rubber mat

ORD. NO.

F UZ 3070 13 07

MDF top with rubber covering

2 side profiles

For single cabinet

Oil-resistant rubber mat

INFO



www.famispa.com

RAI 9011 F.07

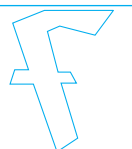

CABINETS SERIES PERFORM-LOOK

PERFORATED PANEL FOR WALL FIXING



■ Set of hooks see page C66

■ Supplied without fixing plugs.

ORD. NO.

F BL 1220 00 04

Perforated panel for wall fixing

Load capacity 25 kg

Dimensions mm: 988x13x456 h



EXAMPLE INCLUDING:

■ RAL 5012

ORD. NO.

F AA ZA02 00 04

1 cabinet ORD. NO. **F AA 1250 01 04** with 2 adjustable shelves

1 cabinet ORD. NO. **F AA 1240 01 04** with 2 adjustable shelves

1 cabinet ORD. NO. **F AA 1200 00 04** with 2 adjustable shelves

1 cabinet ORD. NO. **F AA 1200 00 04** with 4 adjustable shelves + 23 Multibox containers+ 3 containers

1 cabinet ORD. NO. **F AA 1400 00 04** with 4 adjustable shelves

4 perforated panels ORD. NO. **F BL 1220 00 04**

1 set of 95 hooks ORD. NO. **F BL 9517 00 99**

2 MDF tops with rubber mat ORD. NO. **F UZ 3060 11 07**

10 non-slip mattings ORD. NO. **F PX 2541 00 01**

14 edging pieces ORD. NO. **F PX 0241 00 05**

2 corner pieces ORD. NO. **F PX 0741 00 05**

RAL 7000 F.01

RAL 6011 F.02

RAL 5012 F.04

RAL 7035 F.08

INFO ■

www.famispa.com





CABINETS SERIES PERFORM A124



ORD. NO. F AA 1303 S1 08
RAL 7035

ORD. NO. F AA 1302 03 08
RAL 7035

FLOOR FIXING SET



2x

- 2 "HILTI" plugs for concrete floors \geq to classes B25/RBK250/MP_A 25 N/mm²
- Recommended traction of the plug: 2.9 KN
- Plug diameter: \varnothing 6 mm

ORD. NO. F AG 9204 00 99

CABINET

ORD. NO.

F AA 1303 S1 08

- 4 adjustable shelves, 8 size 1 blue containers
- 20 size 2 grey containers
- 8 size 3A2 blue containers, 8 size 3 blue containers
- 8 container rails
- 2 perforated panels, 1 set of 92 hooks
- Dim. mm 1023x400x2000 h** Tools excluded

CABINET

ORD. NO.

F AA 1302 03 08

- 4 adjustable shelves
- Dimensions mm 1023x400x2000 h**

RAL 7000 F.01

RAL 6011 F.02

RAL 5012 F.04

RAL 7035 F.08

SUPPLEMENTARY PARTS ■

- **Spare key.** Always indicate the number on the cylinder lock of the key to be replaced.

ORD. NO. R CSC 0002 00

- **Master key.** This type of key opens all the 45 and 46 series locks.

ORD. NO. R CSC 0001 00



LENGTH = 1023 mm DEPTH = 400 mm

CABINETS SERIES PERFORM A124



ORD. NO.

SHELVES

F AA 1303 02 04**1**

Cabinet with 4 perforated panels, 1 shelf depth 250 mm load capacity 25 kg

Load capacity: 800 kg. **Dimensions mm 1023x400x2000 h**

Load capacity of each individual door with perforated panels: 40 kg

ORD. NO. F AA 1303 52 04Including: 1 cabinet ORD. NO. **F AA 1303 02 04**, 1 set of 142 hooks
ORD. NO. **F BL 9525 00 99**, 1 set of 13 hooks ORD. NO. **F BL 9539 00 99**

ORD. NO.

SHELVES

F AA 1300 02 04**6**

Cabinet with 6 shelves depth 345 mm load capacity 100 kg

Load capacity: 800 kg

Dimensions mm 1023x400x2000 h**ORD. NO. F AA 1300 52 04**Including: 1 cabinet ORD. NO. **F AA 1300 02 04**,
28 size 3 grey containers

■ 3 mm thickness polycarbonate doors



ORD. NO.

SHELVES

F AA 1300 01 04**4**

Cabinet with 4 shelves depth 345 mm load capacity 100 kg

Load capacity: 800 kg

Dimensions mm 1023x400x2000 h

ORD. NO.

SHELVES

F AA 1302 03 04**4**

Cabinet with 4 shelves depth 345 mm load capacity 100 kg

Load capacity: 800 kg

Dimensions mm 1023x400x2000 h

■ KEY

RAL 7000 F.01

RAL 6011 F.02

RAL 5012 F.04

RAL 7035 F.08



- The cabinets must be secured to the floor or to the wall
- The cabinets with perforated doors must be secured to the wall
- Top shelf load capacity 80 kg
- All indicated loads are net and refer to evenly distributed weights

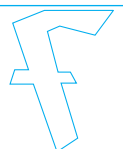

CABINETS SERIES PERFORM A124

EMPTY CABINET WITH DOORS



■ 01
■ 02
■ 04
■ 08

ORD. NO.

F AA 1300 00 04

Load capacity: 800 kg

Dimensions mm 1023x400x2000 h

Internal dimensions mm 995x345x1850 h

The F AA 1300 series cabinets are supplied as standard with 2 floor fixing brackets, 2 wall fixing brackets and 2 levelling devices.

EMPTY CABINET WITH DOORS WITH PERFORATED PANELS



■ 01
■ 02
■ 04
■ 08

ORD. NO.

F AA 1303 00 04

Load capacity: 800 kg

Load capacity of each individual doors: 40 kg

Dimensions mm 1023x400x2000 h

Internal dimensions mm 995x345x1850 h

The F AA 1303 series cabinets are supplied as standard with 2 floor fixing brackets, 2 wall fixing brackets and 2 levelling devices.

EMPTY CABINET WITH 3 mm THICKNESS
POLYCARBONATE DOORS

■ 01
■ 02
■ 04
■ 08

ORD. NO.

F AA 1302 00 04

Load capacity: 800 kg

Dimensions mm 1023x400x2000 h

Internal dimensions mm 995x345x1850 h

The F AA 1302 series cabinets are supplied as standard with 2 floor fixing brackets, 2 wall fixing brackets and 2 levelling devices.

RAL 7000 F.01

RAL 6011 F.02

RAL 5012 F.04

RAL 7035 F.08

KEY ■

- The cabinets must be secured to the floor or to the wall
- The cabinets with perforated doors must be secured to the wall
- Top shelf load capacity 80 kg
- All indicated loads are net and refer to evenly distributed weights

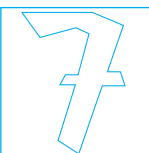

LENGTH = 1023 mm DEPTH = 400 mm

CABINETS SERIES PERFORM A124

**ADJUSTABLE SHELF
DEPTH 345 mm**



■ This type of shelf can be fitted only if the **perforated back panel** is not fitted.



■ Containers see page **G28-G30**

ORD. NO.

DIM. mm

LOAD CAPACITY kg

F AC 2350 01 99

995x345x35 h

100

With 4 hooks

The depth of this shelf is suitable for the following containers:
size 3A2 / size 3



size 3



size 3A2

**ADJUSTABLE SHELF
DEPTH 250 mm**



■ This type of shelf **can** be fitted even in the presence of the **perforated back panel**.



■ Containers see page **G28-G30**

ORD. NO.

DIM. mm

LOAD CAPACITY kg

F AC 2330 06 99

995x250x35 h

25

With 2 guides

The depth of this shelf is suitable for the following containers:
size 2

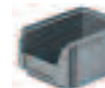

size 2

**CONTAINER
HOOKER RAILS**



■ This type of rail can be applied to the doors with perforated panels or perforated panels fitted inside the cabinet.



■ Containers see page **G28-G30**

ORD. NO.

DIM. mm

LOAD CAPACITY kg

F BL 7438 00 99

445x86 h

10

The following containers can be hooked to this type of rail:
size 1 / size 2



size 1



size 2

**PERFORATED
PANELS**



- 01
- 02
- 04
- 08

■ This type of panel is fitted inside the cabinet by means of 4 brackets complete of screws. A maximum of 4 panels can be fitted in height.

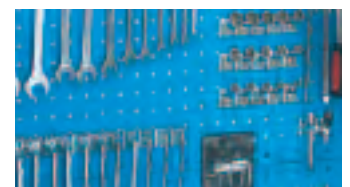

■ Hooks see page **C66**

ORD. NO.

DIM. mm

LOAD CAPACITY kg

F AC 8100 01 04

988x13x456 h

25

With 4 brackets, 4 screws and 4 washers

Not suitable for doors

■ **KEY**

■ RAL 7000 F.01

■ RAL 6011 F.02

■ RAL 5012 F.04

■ RAL 7035 F.08



■ All indicated loads are net and refer to evenly distributed weights

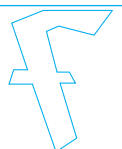

CABINETS SERIES PERFORM A130

LENGTH = 1023 mm DEPTH = 555 mm (54x27 Eh) (24x27 Eh)



ORD. NO. F AA 1403 55 04
RAL 5012



ORD. NO. F AA 1402 01 08
RAL 7035

54 EH (906 mm)

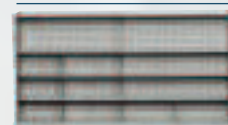

27 EH (447 mm)

24 EH (396 mm)



27 EH (447 mm)

FLOOR FIXING SET



2x

- 2 "HILTI" plugs for concrete floors \geq to classes B25/RBK250/MP_A 25 N/mm²
- Recommended traction of the plug: 2.9 KN
- Plug diameter: \varnothing 6 mm

ORD. NO. F AG 9204 00 99

CABINET

ORD. NO.

F AA 1403 55 04

3 normal extension drawers, 8 adjustable shelves

40 size 1 blue containers

44 size 2 grey containers

16 size 3A2 blue containers

16 container rails

Dim. mm 1023x555x2000 h

Tools excluded

CABINET

ORD. NO.

F AA 1402 01 08

4 galvanised adjustable shelves

Dimensions mm 1023x555x2000 h

Tools excluded

RAL 7000 F.01

RAL 6011 F.02

RAL 5012 F.04

RAL 7035 F.08

SUPPLEMENTARY PARTS ■



- Partitioning material see page A224-A225



- **Spare key.** Always indicate the number on the cylinder lock of the key to be replaced.

ORD. NO. R CSC 0002 00

- **Master key.** This type of key opens all the 45 and 46 series locks.

ORD. NO. R CSC 0001 00



LENGTH = 1023 mm DEPTH = 555 mm (54x27 Eh) (24x27 Eh)

CABINETS SERIES PERFORM A130



The drawers in the cabinet have a maximum load capacity of 350 kg regardless of the load capacity of the cabinets.

Top shelf load capacity 80 kg

ORD. NO.	SHELVES
F AA 1400 01 04	4
Cabinet with 4 shelves depth 500 mm load capacity 100 kg	
Load capacity: 800 kg	
Dimensions mm 1023x555x2000 h	



ORD. NO.	DRAWERS
F AA 1400 02 04	3
Cabinet with 4 shelves depth 500 mm load capacity 100 kg	
3 normal extension drawers load capacity (50 kg)	
Load capacity: 800 kg	
Dimensions mm 1023x555x2000 h	



ORD. NO.	DRAWERS
F AA 1400 07 04	1
Cabinet with 4 shelves depth 500 mm load capacity 100 kg	
1 normal extension drawer load capacity (50 kg)	
Load capacity: 800 kg	
Dimensions mm 1023x555x2000 h	

KEY



- The cabinets must be secured to the floor or to the wall
- Top shelf load capacity 80 kg
- Normal extension (87%)
- All indicated loads are net and refer to evenly distributed weights

RAL 7000 F.01	RAL 6011 F.02	RAL 5012 F.04	RAL 7035 F.08
Partitioning material see page A224-A225			

CABINETS SERIES PERFORM A130

LENGTH = 1023 mm DEPTH = 555 mm (54x27 Eh) (24x27 Eh)



ORD. NO.	DRAWERS
F AA 1400 11 04	9
Cabinet with 2 shelves depth 500 mm load capacity 100 kg	
9 normal extension drawers load capacity 50 kg	
Load capacity: 800 kg. Dimensions mm 1023x555x2000 h	



ORD. NO.	SHELVES
F AA 1400 13 04	7
Cabinet with 7 shelves depth 500 mm load capacity 100 kg	
Load capacity: 800 kg. Dimensions mm 1023x555x2000 h	

ORD. NO. F AA 1400 63 04
Including: 1 cabinet ORD. NO. F AA 1400 13 04
12 size 4A2 blue containers, 12 size 4 grey containers.
Dimensions mm 1023x555x2000 h



ORD. NO.	SHELVES
F AA 1400 15 04	11
Cabinet with 11 shelves depth 500 mm load capacity 100 kg	
Load capacity: 800 kg. Dimensions mm 1023x555x2000 h	

ORD. NO. F AA 1400 65 04
Including: 1 cabinet ORD. NO. F AA 1400 15 04 ,
3 size 272-4 blue stacking containers, 55 blue Multibox 3551, 11 blue
Multibox 3051, 77 guides for Multibox, 66 safety rods for Multibox

■ REQUEST CATALOGUE

For further information about multibox, please check catalogue **no. 400 section G.**

Cabinets with MULTIBOX are supplied with safety rods to prevent the container exiting completely and with guides rails for precise sliding.



RAL 7000 F.01	RAL 6011 F.02	RAL 5012 F.04	RAL 7035 F.08
--------------------	--------------------	--------------------	--------------------

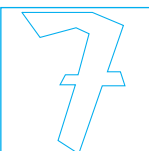

■ Partitioning material see page **A224-A225**

KEY ■

- The cabinets must be secured to the floor or to the wall
- Top shelf load capacity 80 kg
- Normal extension (87%)
- All indicated loads are net and refer to evenly distributed weights



LENGTH = 1023 mm DEPTH = 555 mm (54x27 Eh) (24x27 Eh)

CABINETS SERIES PERFORM A130



■ RAL 7000 + ■ RAL 7035

EXAMPLE INCLUDING:

ORD. NO.

DRAWERS

F AA 1400 08 EF

2

Cabinet with 2 normal extension drawers, load capacity: 800 kg

Dimensions mm 1023x555x2000 h

■ KEY

RAL 7000 F.01

RAL 6011 F.02

RAL 5012 F.04

RAL 7035 F.08

■ Partitioning material see page A224-A225



- The cabinets must be secured to the floor or to the wall
- Top shelf load capacity 80 kg
- Normal extension (87%)

CABINETS SERIES PERFORM A130

LENGTH = 1023 mm DEPTH = 555 mm (54x27 Eh) (24x27 Eh)



ORD. NO.

SHELVES

F AA 1402 01 04**4**

Cabinet with 4 shelves depth 500 mm load capacity 100 kg

Load capacity: 800 kg

Dimensions mm 1023x555x2000 h



ORD. NO.

SHELVES

F AA 1402 02 04**2**

Cabinet with 2 perforated panels, 2 shelves depth 500 mm load capacity 100 kg

Load capacity: 800 kg. **Dimensions mm 1023x555x2000 h****ORD. NO. F AA 1402 52 04**Including: 1 cabinet ORD. NO. **F AA 1402 03 04**,1 set of 43 hooks ORD. NO. **F BL 9515 00 99**

Dim. mm 1023x555x2000 h



ORD. NO.

SHELVES

F AA 1402 03 04**4**

Cabinet with 2 shelves depth 500 mm load capacity 100 kg

2 retractable frames for DIN A4 load capacity 30 kg

Load capacity: 800 kg. **Dimensions mm 1023x555x2000 h**

ORD. NO.

SHELVES

F AA 1402 04 04**4**

Cabinet with 2 perforated panels, 1 shelf depth 480 mm load capacity 50 kg

3 shelves depth 500 mm load capacity 100 kg

Load capacity: 800 kg. **Dimensions mm 1023x555x2000 h****ORD. NO. F AA 1402 54 04**Including: 1 cabinet ORD. NO. **F AA 1402 04 04**, 6 size 4A2 blue containers,6 size 4 grey containers, 1 set of 32 hooks ORD. NO. **F BL 9514 00 99**

Dimensions mm 1023x555x2000 h

RAL 7000 F.01

RAL 6011 F.02

RAL 5012 F.04

RAL 7035 F.08

KEY ■

■ Partitioning material see page A224-A225

- The cabinets must be secured to the floor or to the wall
- Top shelf load capacity 80 kg
- 3 mm thickness polycarbonate doors
- All indicated loads are net and refer to evenly distributed weights



LENGTH = 1023 mm DEPTH = 555 mm (54x27 Eh) (24x27 Eh)

CABINETS SERIES PERFORM A130



ORD. NO.

DRAWERS

F AA 1402 05 04**3**

Cabinet with 2 perforated panels, 1 shelf depth 480 mm load capacity 50 kg
 1 shelf depth 500 mm load capacity 100 kg, 3 normal extension drawers 50 kg
 Load capacity: 800 kg. Dimensions mm 1023x555x2000 h

ORD. NO. F AA 1402 55 04

Including: 1 cabinet ORD. NO. F AA 1402 05 04,
 1 set of 22 hooks ORD. NO. F BL 9522 00 99



ORD. NO.

DRAWERS

F AA 1402 06 04**4**

Cabinet with 3 perforated panels, 1 shelf depth 480 mm load capacity 50 kg
 4 normal extension drawers load capacity 50 kg. Load capacity: 800 kg
 Dimensions mm 1023x555x2000 h

ORD. NO. F AA 1402 56 04

Including: 1 cabinet ORD. NO. F AA 1402 06 04,
 1 set of 95 hooks ORD. NO. F BL 9517 00 99



■ RAL 7035

EXAMPLE INCLUDING:

ORD. NO.

F AA ZA03 00 08

1 cabinet ORD. NO. F AA 1550 01 08 with 2 adjustable shelves
 1 cabinet ORD. NO. F AA 1540 01 08 with 5 adjustable shelves
 + 35 Multibox containers with safety rods
 + 40 guides for Multibox containers
 + 1 normal extension drawer
 1 cabinet with polycarbonate doors ORD. NO. F AA 1402 00 08 with
 4 adjustable shelves

■ KEY

RAL 7000 F.01

RAL 6011 F.02

RAL 5012 F.04

RAL 7035 F.08



- The cabinets must be secured to the floor or to the wall
- Top shelf load capacity 80 kg
- Normal extension (87%)
- 3 mm thickness polycarbonate doors
- All indicated loads are net and refer to evenly distributed weights

■ Partitioning
 material see
 page A224-
 A225



CABINETS SERIES PERFORM A130

LENGTH = 1023 mm DEPTH = 555 mm (54x27 Eh) (24x27 Eh)



ORD. NO.

SHELVES

F AA 1403 01 04**5**

Cabinet with 5 shelves depth 345 mm load capacity 50 kg
2 shelves depth 500 mm load capacity 100 kg, 12 container rails
Load capacity: 800 kg. **Dimensions mm 1023x555x2000 h**

ORD. NO. F AA 1403 51 04

Including: 1 cabinet ORD. NO. F AA 1403 01 04, 48 size 1 blue containers,
5 size 2 grey containers, 20 size 3A2 blue containers, 9 size 4 grey containers
Dimensions mm 1023x555x2000 h



ORD. NO.

DRAWERS

F AA 1403 05 04**3**

Cabinet with 4 shelves depth 250 mm load capacity 25 kg
3 shelves depth 345 mm load capacity 50 kg, 1 shelf depth 500 mm load
capacity 100 kg, 16 container rails, 3 normal extension drawers load capacity
50 kg. Load capacity: 800 kg. **Dimensions mm 1023x555x2000 h**

ORD. NO. F AA 1403 55 04

Including: 1 cabinet ORD. NO. F AA 1403 05 04, 40 size 1 blue containers,
44 size 2 grey containers, 16 size 3A2 blue containers.
Dimensions mm 1023x555x2000 h



ORD. NO.

DRAWERS

F AA 1403 06 04**5**

Cabinet with 4 shelves depth 345 mm load capacity 50 kg, 2 shelves depth 500 mm
load capacity 100 kg, 12 container rails, 3 normal extension drawers load
capacity 50 kg. Load capacity: 800 kg. **Dimensions mm 1023x555x2000 h**

ORD. NO. F AA 1403 56 04

Including: 1 cabinet ORD. NO. F AA 1403 06 04, 48 size 1 blue containers,
5 size 2 grey containers, 20 size 3A2 blue containers.
Dimensions mm 1023x555x2000 h

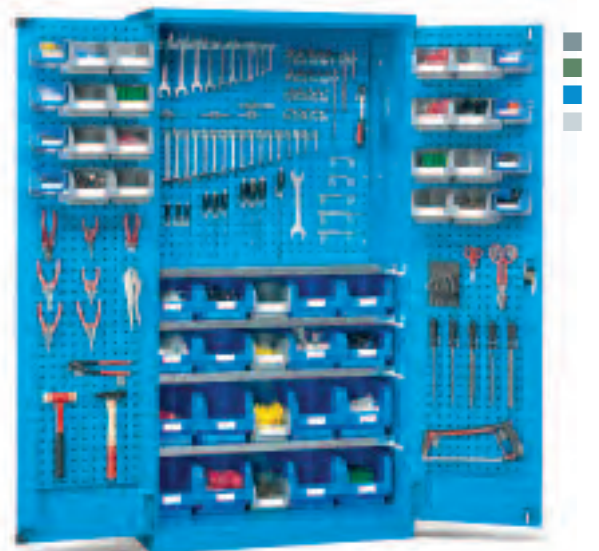

ORD. NO.

SHELVES

F AA 1403 08 04**4**

Cabinet with 2 perforated panels, 4 shelves depth 345 mm load capacity 50 kg,
8 container rails. Load capacity: 800 kg
Dim. mm 1023x555x2000 h

ORD. NO. F AA 1403 58 04

Including: 1 cabinet ORD. NO. F AA 1403 08 04, 8 size 1 blue containers,
20 size 2 grey containers, 8 size 3A2 blue containers, 8 size 3 blue containers,
1 set of 92 hooks ORD. NO. F BL 9521 00 99. **Dim. mm 1023x555x2000 h**

RAL 7000 F.01

RAL 6011 F.02

RAL 5012 F.04

RAL 7035 F.08

KEY ■

■ Partitioning material see page A224-A225

■ Load capacity of each individual door with perforated panels: 40 kg

- The cabinets must be secured to the floor or to the wall
- The cabinets with perforated doors must be secured to the wall
- Top shelf load capacity 80 kg
- Normal extension (87%)
- All indicated loads are net and refer to evenly distributed weights



LENGTH = 1023 mm DEPTH = 555 mm (54x27 Eh) (24x27 Eh)

CABINETS SERIES PERFORM A130



ORD. NO. SHELVES

F AA 1403 10 04 2

Cabinet with 2 perforated panels, 1 shelf depth 480 mm load capacity 50 kg,
1 shelf depth 500 mm load capacity 100 kg, 8 container rails
Load capacity: 800 kg

Dimensions mm 1023x555x2000 h

ORD. NO. F AA 1403 60 04

Including: 1 cabinet ORD. NO. F AA 1403 10 04, 8 size 1 blue containers,
16 size 2 grey containers, 1 set of 43 hooks ORD. NO. F BL 9515 00 99
Dimensions mm 1023x555x2000 h



ORD. NO. DRAWERS

F AA 1403 11 04 3

Cabinet with 2 perforated panels, 1 shelf depth 480 mm load capacity 50 kg,
1 shelf depth 500 mm load capacity 100 kg, 8 container rails
3 normal extension drawers load capacity 50 kg. Load capacity: 800 kg

Dimensions mm 1023x555x2000 h

ORD. NO. F AA 1403 61 04

Including: 1 cabinet ORD. NO. F AA 1403 11 04, 8 size 1 blue containers,
16 size 2 grey containers, 1 set of 22 hooks ORD. NO. F BL 9522 00 99
Dimensions mm 1023x555x2000 h

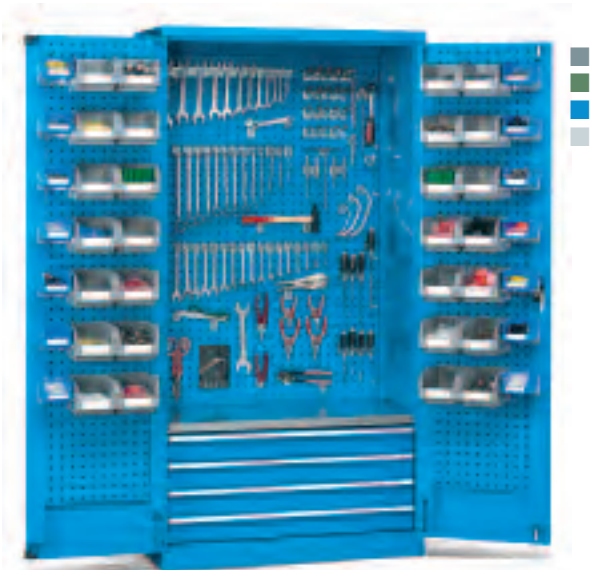

ORD. NO. DRAWERS

F AA 1403 14 04 4

Cabinet with 3 perforated panels, 1 shelf depth 480 mm load capacity 50 kg,
14 container rails, 4 normal extension drawers load capacity 50 kg
Load capacity: 800 kg. Dimensions mm 1023x555x2000 h

ORD. NO. F AA 1403 64 04

Including: 1 cabinet ORD. NO. F AA 1403 14 04, 14 size 1 blue containers,
28 size 2 grey containers, 1 set of 95 hooks ORD. NO. F BL 9517 00 99



■ RAL 7000

EXAMPLE INCLUDING:

ORD. NO. SHELVES

F AA 1403 S1 01 1

1 cabinet ORD. NO. F AA 1403 07 01, 1 wooden worktop ORD. NO. F AC 7620 00 00
12 size 1 blue containers, 48 size 2 blue containers

Dimensions mm 1023x555x2000 h

Tools excluded

■ KEY

■ RAL 7000 F.01

■ RAL 6011 F.02

■ RAL 5012 F.04

■ RAL 7035 F.08



- The cabinets must be secured to the floor or to the wall
- The cabinets with perforated doors must be secured to the wall
- Top shelf load capacity 80 kg
- Normal extension (87%)
- All indicated loads are net and refer to evenly distributed weights

■ Partitioning material see page A224-A225

■ Load capacity of each individual door with perforated panels: 40 kg

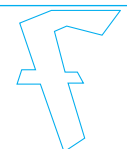

CABINETS SERIES PERFORM



■ RAL 7000 +
■ RAL 5012

EXAMPLE INCLUDING:**ORD. NO.****SHELVES****F AA 1403 S2 71****1**1 cabinet ORD. NO. **F AA 1403**, 1 wooden worktop ORD. NO. **F AC 7620 00 00**

8 size 1 blue containers, 16 size 2 grey containers, 1 set of 64 hooks

Dimensions mm 1023x555x2000 h

Tools and partitioning material excluded

RAL 7000 F.01

RAL 6011 F.02

RAL 5012 F.04

RAL 7035 F.08

SUPPLEMENTARY PARTS ■

■ Partitioning material see page **A224-A225**



■ **Spare key.** Always indicate the number on the cylinder lock of the key to be replaced.

ORD. NO. R CSC 0002 00

■ **Master key.** This type of key opens all the 45 and 46 series locks.

ORD. NO. R CSC 0001 00



LENGTH = 1023 mm DEPTH = 555 mm (54x27 Eh) (24x27 Eh)

CABINETS SERIES PERFORM A220

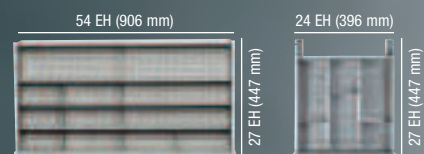

Workstation: see catalogue no. 300.

**ORD. NO.****SHELVES****F AA 1800 01 04****4**

Cabinet with 4 shelves depth 500 mm load capacity 100 kg

Load capacity: 800 kg

Dimensions mm 1023x555x2200 h

**ORD. NO.****DRAWERS****F AA 1800 02 04****3**

Cabinet with 4 shelves depth 500 mm load capacity 100 kg,

3 normal extension drawers load capacity 50 kg. Load capacity: 800 kg

Dimensions mm 1023x555x2200 h

■ KEY

RAL 7000 F.01

RAL 6011 F.02

RAL 5012 F.04

RAL 7035 F.08



- The cabinets must be secured to the floor or to the wall
- The cabinets with perforated doors must be secured to the wall
- Top shelf load capacity 80 kg

■ Partitioning material see page A224-A225

■ Workstations: see page C4



CABINETS SERIES PERFORM

EMPTY CABINET WITH DOORS



- 01
- 02
- 04
- 08

ORD. NO.

F AA 1400 00 04

Load capacity: 800 kg

Dimensions mm 1023x555x2000 h

Internal dimensions mm 995x500x1850 h

The F AA 1400 series cabinets are supplied as standard with 2 floor fixing brackets, 2 wall fixing brackets and 2 levelling devices.

EMPTY CABINET WITH DOORS WITH PERFORATED PANELS



- 01
- 02
- 04
- 08

ORD. NO.

F AA 1403 00 04

Load capacity: 800 kg

Load capacity of each individual door: 40 kg

Dimensions mm 1023x555x2000 h

Internal dimensions mm 995x500x1850 h

The F AA 1403 series cabinets are supplied as standard with 2 floor fixing brackets, 2 wall fixing brackets and 2 levelling devices.

EMPTY CABINET WITH 3 mm THICKNESS POLYCARBONATE DOORS



- 01
- 02
- 04
- 08

ORD. NO.

F AA 1402 00 04

Load capacity: 800 kg

Dimensions mm 1023x555x2000 h

Internal dimensions mm 995x500x1850 h

The F AA 1402 series cabinets are supplied as standard with 2 floor fixing brackets, 2 wall fixing brackets and 2 levelling devices.



- 01
- 02
- 04
- 08

EMPTY CABINET WITH ROLLER SHUTTER

ORD. NO.

F AA 1800 00 04

Load capacity: 800 kg

Dimensions mm 1023x555x2200 h

Internal dimensions mm 995x500x1820 h

The F AA 1800 series cabinets are supplied as standard with 2 floor fixing brackets, 2 wall fixing brackets and 2 levelling devices.

■ The cabinets must be secured to the floor or to the wall. If one or more drawers are fitted, the cabinets must be secured to the floor or to the wall (if the drawers are fitted at a height over 1000 mm from the floor, the cabinet must be secured to the wall only). **The cabinets with perforated doors must be secured to the wall.**

■ The drawers in the cabinet have a maximum load capacity of 350 kg regardless of the load capacity of the cabinets.

PAIR OF NORMAL AND TELESCOPIC EXTENSION DRAWERS 24x27 EH

- 01
- 02
- 04



ORD. NO.

EXTENSION

F AC 1600 00 04

NORMAL

F AC 1650 00 04

TELESCOPIC

Normal extension drawer load capacity: 50 kg

Full extension drawer load capacity: 60 kg

Internal dim. mm 396x447x85 h (each drawer)

NORMAL AND TELESCOPIC EXTENSION DRAWERS 54x27 EH

- 01
- 02
- 04



ORD. NO.

EXTENSION

F AC 1200 00 04

NORMAL

F AC 1250 00 04

TELESCOPIC

Normal extension drawer load capacity: 50 kg

Full extension drawer load capacity: 100 kg

Internal dim. mm 906x447x85 h

TELESCOPIC EXTENSION SUSPENSION FOLDER FRAME FOR SUSPENSION FOLDER DIN A4



ORD. NO.

OVERALL DIM. mm

F AC 7500 00 07

990x500

The suspension folder frames are supplied with telescopic extension guide rails (100% extension) with 30 kg load capacity.

For suspension folders DIN A4

RAL 7000 F.01 RAL 6011 F.02 RAL 5012 F.04 RAL 7035 F.08

KEY ■



■ All indicated loads are net and refer to evenly distributed weights

■ Partitioning material see page A224-A225

- The cabinets must be secured to the floor or to the wall
- The cabinets with perforated doors must be secured to the wall
- Top shelf load capacity 80 kg (F AA 1400 /1402/1403)
- Normal extension (87%)
- Telescopic extension (100%)



LENGTH = 1023 mm DEPTH = 555 mm (54x27 Eh) (24x27 Eh)

CABINETS SERIES PERFORM

**ADJUSTABLE SHELF
DEPTH 500 mm**



■ 99

ORD. NO.	DIM. mm	STRENGTH. BAR	LOAD CAP. kg
F AC 2500 01 99	995x500x35 h	0	100
F AC 2500 03 99	995x500x35 h	1	180

The depth of this shelf is suitable for the following containers:
size 4A2 / size 4 / size 4A5

■ This type of shelf can be fitted only if the **perforated back panel** is **not** fitted. It is **not** possible to fit Multibox series containers on shelves with **1 strengthening bar**.



size 4A2 size 4 size 4A5



■ Containers see page G28-G30

**ADJUSTABLE SHELF
DEPTH 480 mm**



■ 99

ORD. NO.	DIM. mm	LOAD CAPACITY kg
F AC 2480 07 99	995x480x35 h	50

The depth of this shelf is suitable for the following containers:
size 4A2 / size 4 / size 4A5

■ This type of shelf **can** be fitted even in the presence of the **perforated back panel**.



size 4A5 size 4 size 4A2

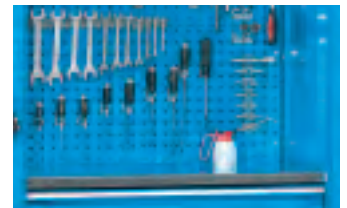

■ Containers see page G28-G30

**ADJUSTABLE SHELF
DEPTH 345 mm**



■ 99

ORD. NO.	DIM. mm	LOAD CAPACITY kg
F AC 2350 07 99	995x345x35 h	50

The depth of this shelf is suitable for the following containers:
size 3A2 / size 3

■ This type of shelf **can** be fitted when the **perforated back panel** is used or when the size 1 containers are hooked on the perforated door panels.



size 3 size 3A2



■ Containers see page G28-G30

**ADJUSTABLE SHELF
DEPTH 250 mm**

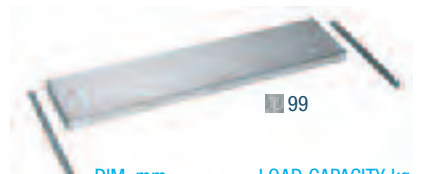

■ 99

ORD. NO.	DIM. mm	LOAD CAPACITY kg
F AC 2330 07 99	995x345x35 h	25

The depth of this shelf is suitable for the following containers:
size 2

■ This type of shelf **can** be fitted when the **perforated back panel** is used or when the size 2 containers are hooked on the perforated door panels.



size 2



■ Containers see page G28-G30

CONTAINER RAILS



■ 99

ORD. NO.	DIM mm	LOAD CAPACITY kg
F BL 7438 00 99	445x86 h	10

The depth of this shelf is suitable for the following containers:
size 1 / size 2

■ This type of rail can be applied to the doors with perforated panels or to the perforated panels fitted inside the cabinet.

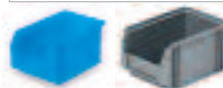

size 1 size 2



■ Containers see page G28-G30

**PERFORATED
PANELS**



■ 01
■ 02
■ 04
■ 08

ORD. NO.	DIM. mm	LOAD CAPACITY kg
F AC 8100 01 04	988x13x456 h	25

With 4 brackets, 4 screws e 4 washers

Not suitable for doors

■ This type of panel is fitted inside the cabinet by means of 4 brackets complete of screws. A maximum of 4 panels can be fitted in height.

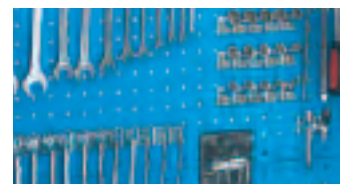

■ Hooks see page C66

CABINETS SERIES PERFORM A

27x27 Eh

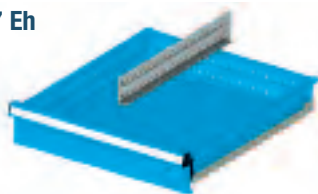

ORD. NO.	FOR FRONT HEIGHTS
F FH 0100 01 00	100
Set including:	
1 Slotted partition	455 mm

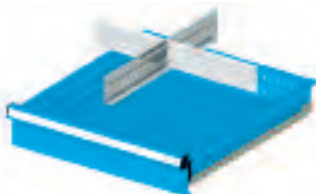

ORD. NO.	FOR FRONT HEIGHTS
F FH 0100 02 00	100
Set including:	
1 Slotted partition	455 mm
1 Plain partition	200 mm
1 Plain partition	251 mm

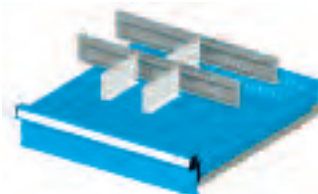

ORD. NO.	FOR FRONT HEIGHTS
F FH 0100 04 00	100
Set including:	
2 Slotted partitions	455 mm
3 Plain partitions	149 mm

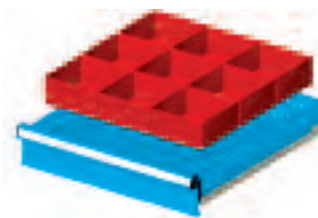

ORD. NO.	FOR FRONT HEIGHTS
F FH 0100 07 00	100
Set including:	
9 Plastic boxes	150x150 mm

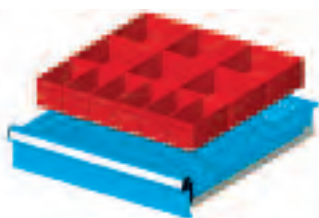

ORD. NO.	FOR FRONT HEIGHTS
F FH 0100 08 00	100
Set including:	
6 Plastic boxes	150x75 mm
6 Plastic boxes	150x150 mm

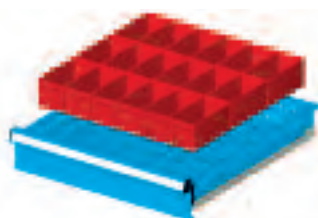

ORD. NO.	FOR FRONT HEIGHTS
F FH 0100 09 00	100
Set including:	
18 Plastic boxes	150x75 mm

64x27 Eh

■ Partitioning material see page A180

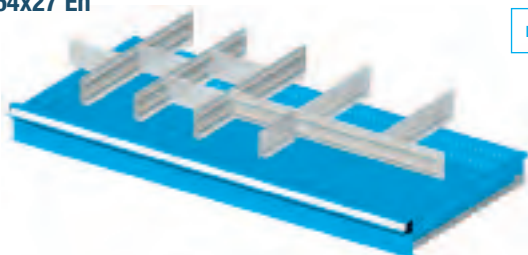

ORD. NO.	FOR FRONT HEIGHTS
F FH 0250 03 00	100
Set including:	
3 Slotted partitions	455 mm
1 Slotted partition	600 mm
3 Plain partitions	149 mm
2 Plain partitions	166 mm
2 Plain partitions	302 mm

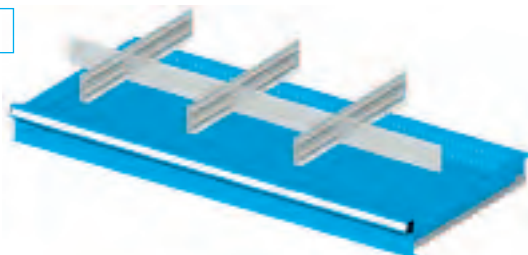

ORD. NO.	FOR FRONT HEIGHTS
F FH 0250 04 00	100
Set including:	
3 Slotted partitions	455 mm
1 Plain partition	166 mm
3 Plain partitions	302 mm

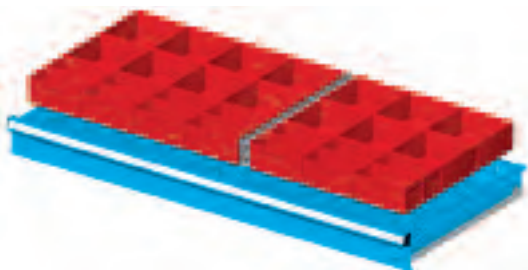

ORD. NO.	FOR FRONT HEIGHTS
F FH 0250 05 00	100
Set including:	
1 Slotted partition	455 mm
14 Plastic boxes	150x75 mm
14 Plastic boxes	150x150 mm

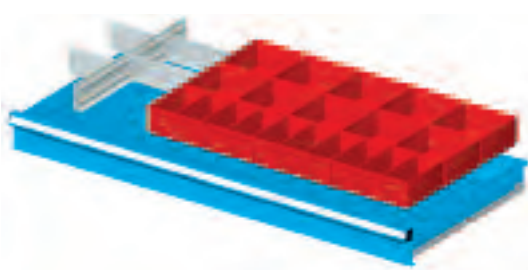

ORD. NO.	FOR FRONT HEIGHTS
F FH 0250 06 00	100
Set including:	
2 Slotted partitions	455 mm
2 Plain partitions	132 mm
2 Plain partitions	200 mm
10 Plastic boxes	150x75 mm
10 Plastic boxes	150x150 mm

24X27 EH / 54X27 EH

CABINETS SERIES PERFORM A

24x27 Eh

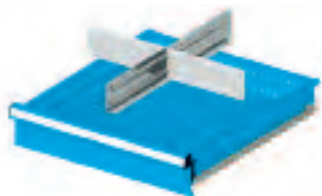

ORD. NO.	FOR FRONT HEIGHTS
F FH 0050 01 00	100
Set including:	
1 Slotted partition	455 mm
2 Plain partitions	200 mm

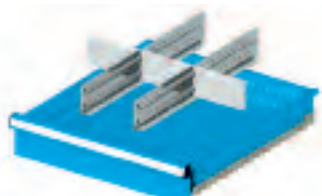

ORD. NO.	FOR FRONT HEIGHTS
F FH 0050 02 00	100
Set including:	
2 Slotted partitions	455 mm
3 Plain partitions	132 mm

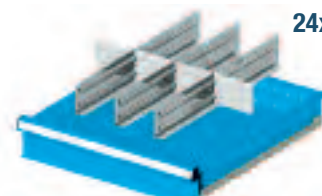

ORD. NO.	FOR FRONT HEIGHTS
F FH 0050 03 00	100
Set including:	
3 Slotted partitions	455 mm
4 Plain partitions	98 mm

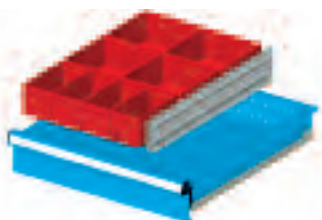

ORD. NO.	FOR FRONT HEIGHTS
F FH 0050 07 00	100
Set including:	
1 Slotted partition	455 mm
4 Plastic boxes	150x75 mm
4 Plastic boxes	150x150 mm

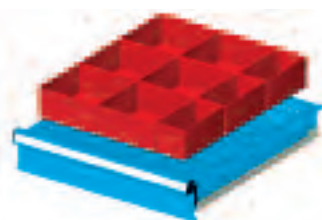

ORD. NO.	FOR FRONT HEIGHTS
F FH 0050 08 00	100
Set including:	
3 Plastic boxes	150x75 mm
6 Plastic boxes	150x150 mm

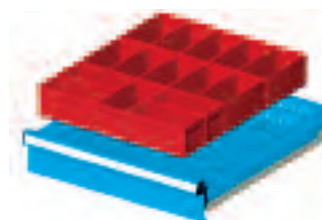

ORD. NO.	FOR FRONT HEIGHTS
F FH 0050 09 00	100
Set including:	
15 Plastic boxes	150x75 mm

■ Partitioning material see page A180

54x27 Eh

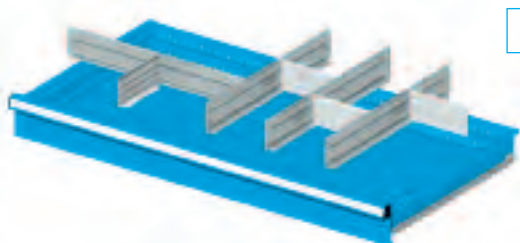

ORD. NO.	FOR FRONT HEIGHTS
F FH 0200 01 00	100
Set including:	
4 Slotted partitions	455 mm
4 Plain partitions	149 mm

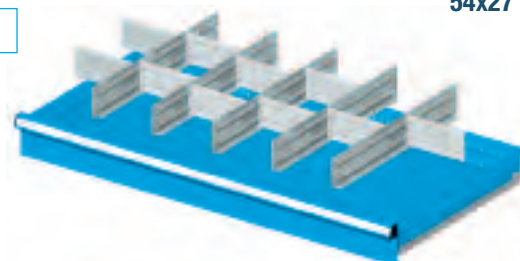

ORD. NO.	FOR FRONT HEIGHTS
F FH 0200 02 00	100
Set including:	
5 Slotted partitions	455 mm
10 Plain partitions	149 mm

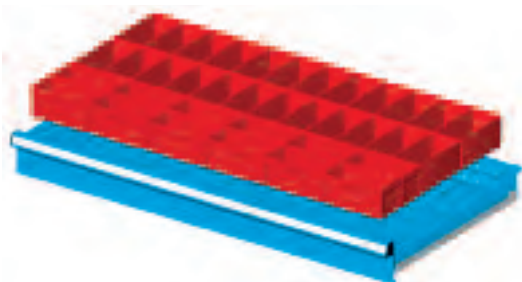

ORD. NO.	FOR FRONT HEIGHTS
F FH 0200 05 00	100
Set including:	
36 Plastic boxes	150x75 mm

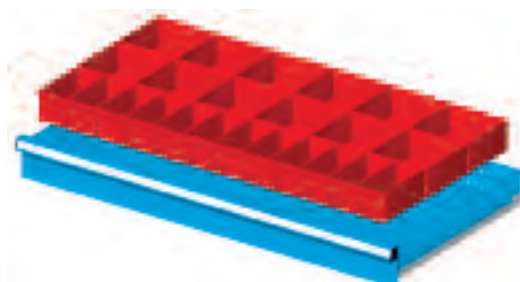

ORD. NO.	FOR FRONT HEIGHTS
F FH 0200 06 00	100
Set including:	
12 Plastic boxes	150x75 mm
12 Plastic boxes	150x150 mm

CABINETS SERIES PERFORM A700

ORD. NO. F AB 7302 01 01
RAL 7000ORD. NO. F AB 7200 02 04
RAL 5012ORD. NO. F AB 7100 03 08
RAL 7035

FLOOR FIXING SET



2x

- 2 "HILTI" plugs for concrete floors \geq to classes B25/RBK250/MP_A 25 N/mm²
- Recommended traction of the plug: 2.9 KN
- Plug diameter: \varnothing 6 mm

ORD. NO. F AG 9204 00 99

CABINET

ORD. NO.

F AB 7100 03 08

Complete with:
4 galvanised adjustable shelves
1 centre support

Dim. mm 2046x450x2000 h

Storage containers excluded

CABINET

ORD. NO.

F AB 7200 02 04

Complete with:
2 galvanised adjustable shelves
1 centre support

Dim. mm 2046x450x1200 h

CABINET

ORD. NO.

F AB 7302 01 01

Complete with:
8 galvanised adjustable shelves
1 centre support

Dim. mm 2046x450x2000 h

Tools excluded

RAL 7000 F.01

RAL 6011 F.02

RAL 5012 F.04

RAL 7035 F.08

SUPPLEMENTARY PARTS ■



- 4 mm thickness polycarbonate doors



- **Spare key.** Always indicate the number on the cylinder lock of the key to be replaced.

ORD. NO. R CSC 0002 00

- **Master key.** This type of key opens all the 45 and 46 series locks.

ORD. NO. R CSC 0001 00



LENGTH = 2046 mm DEPTH = 450 mm

CABINETS SERIES PERFORM A700



ORD. NO.	SHELVES
F AB 7100 02 04	2
Cabinet with 2 shelves depth 370 mm load capacity 100 kg	
1 centre support	
Cabinet load capacity: 300 kg per compartment	
Dimensions mm 2046x450x1000 h	

ORD. NO.	SHELVES
F AB 7100 03 04	4
Cabinet with 4 shelves depth 370 mm load capacity 100 kg	
1 centre support	
Cabinet load capacity: 300 kg per compartment	
Dimensions mm 2046x450x1000 h	



ORD. NO.	SHELVES
F AB 7200 03 04	4
Cabinet with 4 shelves depth 370 mm load capacity 100 kg	
1 centre support	
Cabinet load capacity: 300 kg per compartment	
Dimensions mm 2046x450x1200 h	

ORD. NO.	SHELVES
F AB 7200 06 04	2
Cabinet with 2 shelves depth 370 mm load capacity 100 kg	
2 retractable frames for DIN A4 folders load capacity 30 kg	
1 centre support	
Cabinet load capacity: 300 kg per compartment	
Dimensions mm 2046x450x1200 h	

ORD. NO. F AB 7200 53 04
Including: 1 cabinet ORD. NO. **F AB 7200 03 04**, 2 size 2 grey containers,
8 size 3 blue containers

KEY

RAL 7000 F.01 RAL 6011 F.02 RAL 5012 F.04 RAL 7035 F.08



- If the cabinet is with retractable frames it must be fixed to the floor or to the wall
- Top shelf load capacity 80 kg
- All indicated loads are net and refer to evenly distributed weights

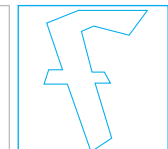
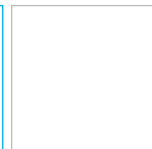
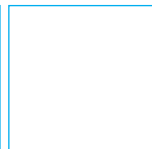

CABINETS SERIES PERFORM A700



ORD. NO.

SHELVES

F AB 7300 01 04**8**

Cabinet with 8 shelves depth 370 mm load capacity 100 kg

1 centre support

Cabinet load capacity: 400 kg per compartment

Dimensions mm 2046x450x2000 h



ORD. NO.

SHELVES

F AB 7300 03 04**10**

Cabinet with 10 shelves depth 370 mm load capacity 100 kg, 1 centre support

Cabinet load capacity: 400 kg per compartment

Dimensions mm 2046x450x2000 h

ORD. NO. **F AB 7300 53 04**Including: 1 cabinet ORD. NO. **F AB 7300 03 04**, 6 size 2 grey containers, 8 size 3A2 blue containers, 16 size 3 blue containers

ORD. NO.

SHELVES

F AB 7300 05 04**4**

Cabinet with 4 shelves depth 370 mm load capacity 100 kg

4 retractable frames for DIN A4 folders load capacity 300 kg

1 centre support

Cabinet load capacity: 400 kg per compartment

Dimensions mm 2046x450x2000 h



ORD. NO.

SHELVES

F AB 7302 01 04**8**

Cabinet with 8 shelves depth 370 mm load capacity 100 kg, 1 centre support

Cabinet load capacity: 400 kg per compartment

Dimensions mm 2046x450x2000 h

ORD. NO. **F AB 7302 51 04**Including: 1 cabinet ORD. NO. **F AB 7302 01 04**, 2 size 2 grey containers, 4 size 3A2 blue containers, 4 size 3 blue containers

RAL 7000 F.01

RAL 6011 F.02

RAL 5012 F.04

RAL 7035 F.08

KEY ■



■ 4 mm thickness polycarbonate doors

- The cabinets must be secured to the floor or to the wall
- Top shelf load capacity 80 kg
- All indicated loads are net and refer to evenly distributed weights



LENGTH = 2046 mm DEPTH = 450 mm

CABINETS SERIES PERFORM A700



■ RAL 7000

EXAMPLE INCLUDING:

ORD. NO.

F AB ZA01 00 01

1 cabinet ORD. NO. **F AB 7302 00 01** with 5 adjustable shelves, 4 perforated panels e 1 set of 95 hooks (tools excluded)

1 cabinet ORD. NO. **F AB 7100 01 01** with 6 adjustable shelves, 8 size 3A2 blue containers e 24 size 3 blue containers

1 upper shelf ORD. NO. **F UZ 3040 13 07**, 8 Practibox ORD. NO. **F PG 1571 01 01**

10 non-slip mattings ORD. NO. **F PX 2541 00 01** with edging and corner

Dimensions mm 4092x450x2000 h

Tools excluded

■ INFO

RAL 7000 F.01

RAL 6011 F.02

RAL 5012 F.04

RAL 7035 F.08



www.famispaspa.com



CABINETS SERIES PERFORM A700

EMPTY CABINET WITH DOORS AND CENTRE SUPPORT



■ 01
■ 02
■ 04
■ 08

ORD. NO.

F AB 7100 01 04

Load capacity: 300 kg per compartment

Dimensions mm 2046x450x1000 h

Internal dimensions of each compartment mm 995x370x850 h

The F AB 7100 series cabinets are supplied as standard with 2 floor fixing brackets, 2 wall fixing brackets and 2 levelling devices.

EMPTY CABINET WITH DOORS AND CENTRE SUPPORT



■ 01
■ 02
■ 04
■ 08

ORD. NO.

F AB 7200 01 04

Load capacity: 300 kg per compartment

Dimensions mm 2046x450x1200 h

Internal dimensions of each compartment mm 995x370x1050 h

The F AB 7200 series cabinets are supplied as standard with 2 floor fixing brackets, 2 wall fixing brackets and 2 levelling devices.

EMPTY CABINET WITH DOORS AND CENTRE SUPPORT



■ 01
■ 02
■ 04
■ 08

ORD. NO.

F AB 7300 00 04

Load capacity: 400 kg per compartment

Dimensions mm 2046x450x2000 h

Internal dimensions of each compartment mm 995x370x1850 h

The F AB 7300 series cabinets are supplied as standard with 4 floor fixing brackets, 4 wall fixing brackets and 4 levelling devices.

EMPTY CABINET WITH POLYCARBONATE DOORS AND CENTRE SUPPORT



■ 01
■ 02
■ 04
■ 08

ORD. NO.

F AB 7302 00 04

Load capacity: 400 kg per compartment

Dimensions mm 2046x450x2000 h

Internal dimensions of each compartment mm 995x370x1850 h

The F AB 7302 series cabinets are supplied as standard with 4 floor fixing brackets, 4 wall fixing brackets and 4 levelling devices.

■ 4 mm thickness polycarbonate doors

■ Fixing cabinets series F AB 7100 / F AB 7200

The cabinet should be fixed to the floor or to the wall. If the cabinets are placed on the top of the other, they must be secured to the wall.

■ Fixing cabinets series F AB 7300 / F AB 7302

The cabinets must be secured to the floor or to the wall. If the cabinets are placed on the top of the other, they must be secured to the wall.

FULL EXTENSION SUSPENSION FOLDER FRAME FOR SUSPENSION FOLDER DIN A4

ORD. NO.

F AC 7400 00 07

The suspension folder frames are supplied with full extension guide rails (100% extension) with 30 kg load capacity

Overall dimensions: 990x370 mm

For suspension folders DIN A4

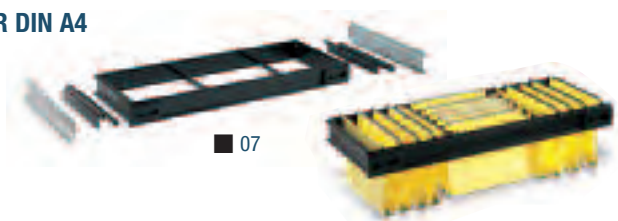

■ 07

RAL 7000 F.01 RAL 6011 F.02 RAL 5012 F.04 RAL 7035 F.08

KEY ■

■ All indicated loads are net and refer to evenly distributed weights



LENGTH = 2046 mm DEPTH = 450 mm

CABINETS SERIES PERFORM A700

ADJUSTABLE SHELF
DEPTH 370 mm



■ This type of shelf can be assembled only if the **perforated back panel is not fitted**.



■ Containers see page G28-G30



size 3

size 3A2

ORD. NO.	DIM. mm	STRENGTH. BAR	LOAD CAPACITY kg
F AC 2450 01 99	995x370x35 h	0	100
F AC 2450 03 99	995x370x35 h	1	150

With 4 hooks

The depth of this shelf is suitable for the following containers:
size 3A2 / size 3

TOP SHELF WITH 3 EDGES



■ 07



■ Oil-resistant rubber

PERFORATED PANEL

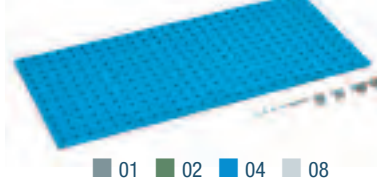

■ 01 ■ 02 ■ 04 ■ 08

■ This type of panel is fitted inside the cabinet by means of 4 brackets complete of screws. A maximum of 4 panels can be fitted in height.

■ Hooks see page C66

ORD. NO.	DIM. mm
F AC 4450 01 07	2046x450x20 h

For cabinet F AB 7100 / 7200

ORD. NO.	DIM. mm	LOAD CAPACITY kg
F AC 8100 01 04	988x13x456 h	25

With 4 brackets, 4 screws and 4 washers

UPPER MDF TOP WITH RUBBER OR PVC COVERING DIMENSIONS 2046x450x31,5 mm H

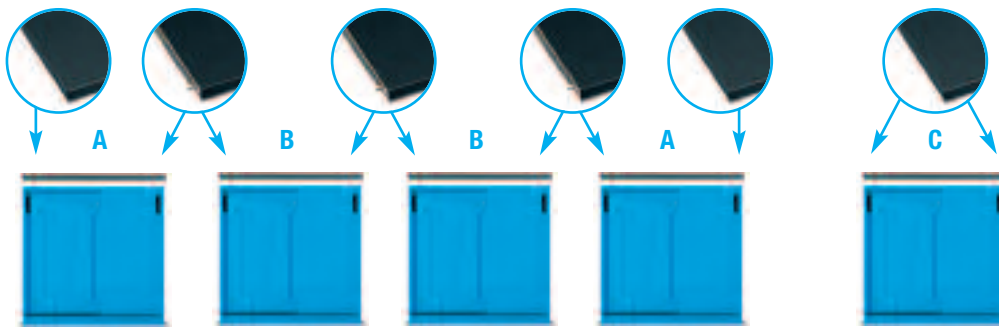

ORD. NO. F UZ 9997 00 00

Drilling of the cabinet upper shelf for the MDF top fixing.



Detail of the oil-resistant rubber



A



B

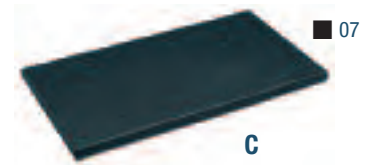

C

ORD. NO.
F UZ 3040 11 07
MDF top with rubber covering
Side profile
For end cabinets
Oil-resistant rubber mat

ORD. NO.
F UZ 3040 12 07
MDF top with rubber covering
No side profile
For additional central cabinets
Oil-resistant rubber mat

ORD. NO.
F UZ 3040 13 07
MDF top with rubber covering
2 side profiles
For single cabinet
Oil-resistant rubber mat

■ KEY

RAL 7000 F.01 RAL 6011 F.02 RAL 5012 F.04 RAL 7035 F.08



■ All indicated loads are net and refer to evenly distributed weights



ORD. NO. F AB 5302 02 08
RAL 7035ORD. NO. F AB 5200 03 04
RAL 5012ORD. NO. F AB 5100 03 01
RAL 7000

FLOOR FIXING SET



2x

- 2 "HILTI" plugs for concrete floors \geq to classes B25/RBK250/MP_A 25 N/mm²
- Recommended traction of the plug: 2.9 KN
- Plug diameter: \varnothing 6 mm

ORD. NO. F AG 9204 00 99

CABINET

ORD. NO.

F AB 5100 03 01

Complete with:
2 galvanised adjustable shelves
Dim. mm 1500x450x1000 h

Accessories excluded

CABINET

ORD. NO.

F AB 5200 03 04

Complete with:
2 galvanised adjustable shelves
Dim. mm 1500x450x1200 h

CABINET

ORD. NO.

F AB 5302 02 08

Complete with:
8 galvanised adjustable shelves
1 centre support
Dim. mm 1500x450x2000 h

Accessories excluded

RAL 7000 F.01

RAL 6011 F.02

RAL 5012 F.04

RAL 7035 F.08

SUPPLEMENTARY PARTS ■

- **Spare key.** Always indicate the number on the cylinder lock of the key to be replaced.

ORD. NO. R CSC 0002 00

- **Master key.** This type of key opens all the 45 and 46 series locks.

ORD. NO. R CSC 0001 00



LENGTH = 1500 mm DEPTH = 450 mm (78x36 Eh)

CABINETS SERIES PERFORM A500



ORD. NO. SHELVES

F AB 5100 02 04 1

Cabinet with 1 shelf depth 370 mm load capacity 100 kg

Without centre support

Cabinet load capacity: 600 kg. **Dimensions mm 1500x450x1000 h**



ORD. NO. SHELVES

F AB 5100 06 04 2

Cabinet with 2 shelves depth 370 mm load capacity 150 kg

1 centre support

Cabinet load capacity: 600 kg. **Dimensions mm 1500x450x1000 h**



ORD. NO. SHELVES

F AB 5200 03 04 2

Cabinet with 2 shelves depth 370 mm load capacity 100 kg

Without centre support

Cabinet load capacity: 600 kg. **Dimensions mm 1500x450x1200 h**



ORD. NO. SHELVES

F AB 5200 08 04 4

Cabinet with 4 shelves depth 370 mm load capacity 150 kg

1 centre support

Cabinet load capacity: 600 kg. **Dimensions mm 1500x450x1200 h**

ORD. NO. F AB 5200 53 04

Including: 1 cabinet ORD. NO. **F AB 5200 03 04**, 6 size 3 blue containers

EXAMPLE INCLUDING:

ORD. NO.

F AB ZA02 00 EF

2 cabinets without doors ORD. NO. **F AB 5101 00 01**
with 2 adjustable shelves each

2 pairs of sliding doors ORD. NO. **F AC 0210 00 08**

2 upper shelves ORD. NO. **F UZ 3030 11 07**

Dimensions mm 3000x450x1030 h

Tools excluded

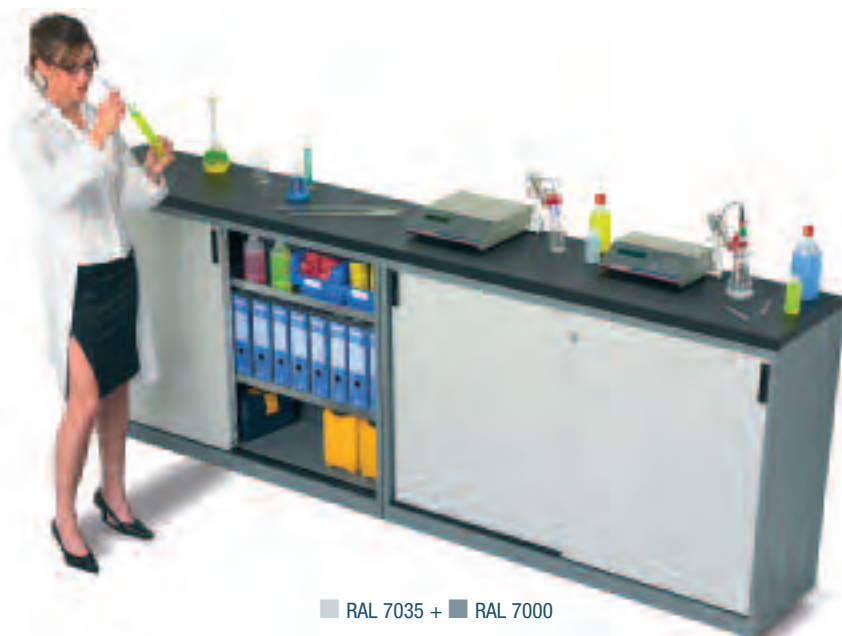

■ RAL 7035 + ■ RAL 7000

■ KEY

■ RAL 7000 F.01 ■ RAL 6011 F.02 ■ RAL 5012 F.04 ■ RAL 7035 F.08



- We suggest to secure the cabinet to the floor or to the wall
- Top shelf load capacity 80 kg
- All indicated loads are net and refer to evenly distributed weights



CABINETS SERIES PERFORM A500

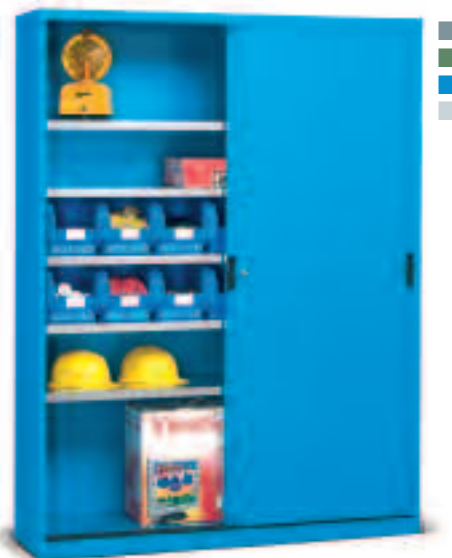

ORD. NO.	SHELVES
F AB 5300 02 04	4
Cabinet with 4 shelves depth 370 mm load capacity 100 kg	
Without centre support	
Cabinet load capacity: 800 kg	
Dimensions mm 1500x450x2000 h	

ORD. NO.	SHELVES
F AB 5300 04 04	5
Cabinet with 5 shelves depth 370 mm load capacity 100 kg	
Without centre support. Cabinet load capacity: 800 kg	
Dimensions mm 1500x450x2000 h	

ORD. NO. F AB 5300 54 04
 Including: 1 cabinet ORD. NO. **F AB 5300 04 04**, 12 size 3 blue containers

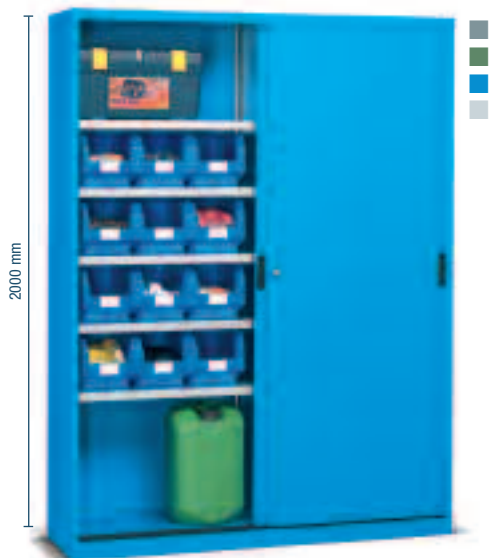

ORD. NO.	SHELVES
F AB 5300 07 04	10
Cabinet with 10 shelves depth 370 mm load capacity 150 kg, 1 centre support	
Cabinet load capacity: 800 kg	
Dimensions mm 1500x450x2000 h	

ORD. NO.	SHELVES
F AB 5302 02 04	8
Cabinet with 8 shelves depth 370 mm load capacity 150 kg, 1 centre support	
Cabinet load capacity: 800 kg	
Dimensions mm 1500x450x2000 h	

ORD. NO. F AB 5300 57 04
 Including: 1 cabinet ORD. NO. **F AB 5300 07 04**, 24 size 3 blue containers

ORD. NO. F AB 5302 52 04
 Including: 1 cabinet ORD. NO. **F AB 5302 02 04**, 9 size 3 blue containers

RAL 7000 F.01 RAL 6011 F.02 RAL 5012 F.04 RAL 7035 F.08

KEY ■



■ 3 mm thickness polycarbonate doors

- The cabinets must be secured to the floor or to the wall
- Top shelf load capacity 80 kg
- All indicated loads are net and refer to evenly distributed weights



LENGTH = 1500 mm DEPTH = 450 mm

CABINETS SERIES PERFORM A500



EXAMPLE INCLUDING:

ORD. NO.

F AB ZA03 00 3U

2 cabinets ORD. NO. **F AB 5302 00 3U**, 1 centre support ORD. NO. **F AC 3300 00 99**

2 cabinets ORD. NO. **F AB 5200 00 3U**, 8 galvanised adjustable shelves ORD. NO. **F AC 2250 01 99**, 8 galvanised adjustable shelves ORD. NO. **F AC 2650 01 99**

2 upper shelves ORD. NO. **F UZ 3030 31 00**

2 perforated panels prepared for wall fixing (supplied without plugs) ORD. NO. **F BL 1220 00 3U**

Dimensions mm 6000x450x2000 h

Tools excluded

■ **INFO**

RAL 7000 F.01

RAL 6011 F.02

RAL 5012 F.04

RAL 7035 F.08



www.famispa.com

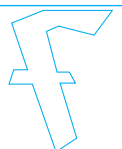

CABINETS SERIES PERFORM A500

EMPTY CABINET WITH DOORS WITHOUT CENTRE SUPPORT



ORD. NO.

F AB 5100 00 04

Load capacity: 600 kg

Dimensions mm 1500x450x1000 h

Internal dimensions mm 1470x370x850 h

The F AB 5100 series cabinets are supplied as standard with 2 floor fixing brackets, 2 wall fixing brackets and 2 levelling devices.

EMPTY CABINET WITH DOORS WITHOUT CENTRE SUPPORT



ORD. NO.

F AB 5200 00 04

Load capacity: 600 kg

Dimensions mm 1500x450x1200 h

Internal dimensions mm 1470x370x1050 h

The F AB 5200 series cabinets are supplied as standard with 2 floor fixing brackets, 2 wall fixing brackets and 2 levelling devices.

EMPTY CABINET WITH DOORS WITHOUT CENTRE SUPPORT



ORD. NO.

F AB 5300 00 04

Load capacity: 800 kg

Dimensions mm 1500x450x2000 h

Internal dimensions mm 1470x370x1850 h

The F AB 5300 series cabinets are supplied as standard with 2 floor fixing brackets, 2 wall fixing brackets and 2 levelling devices.

EMPTY CABINET WITH POLYCARBONATE DOORS WITHOUT CENTRE SUPPORT



ORD. NO.

F AB 5302 00 04

Load capacity: 800 kg

Dimensions mm 1500x450x2000 h

Internal dimensions mm 1470x370x1850 h

The F AB 5302 series cabinets are supplied as standard with 2 floor fixing brackets, 2 wall fixing brackets and 2 levelling devices.

■ 3 mm thickness polycarbonate doors

■ **Fixing cabinets series F AB 5100 / F AB 5200**
The cabinet should be fixed to the floor or to the wall. If the cabinets are placed on the top of the other, they must be secured to the wall.

■ **Fixing cabinets series F AB 5300 / F AB 5302**
The cabinets must be secured to the floor or to the wall. If the cabinets are placed on the top of the other, they must be secured to the wall.

TOP SHELF WITH 3 EDGES

ORD. NO.

DIM. mm

F AC 4350 01 07

1500x450x20 h

For cabinet F AB 5100 / 5200



■ Oil-resistant rubber mat

RAL 7000 F.01 RAL 6011 F.02 RAL 5012 F.04 RAL 7035 F.08

INFO ■

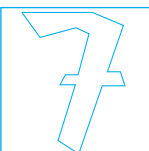

LENGTH = 1500 mm DEPTH = 450 mm

CABINETS SERIES PERFORM A500

ADJUSTABLE SHELF DEPTH 370 mm

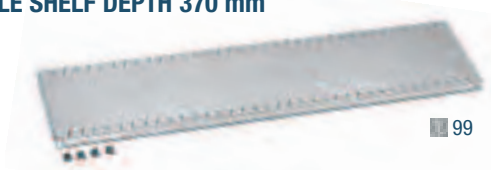

■ 99

ADJUSTABLE SHELF DEPTH 370 mm



■ 99

ORD. NO.	DIM. mm	LOAD CAPACITY kg
F AC 2650 01 99	1470x370x35 h	100
With 4 hooks		
The depth of this shelf is suitable for the following containers: size 3A2 / size 3		

ORD. NO.	DIM. mm	LOAD CAPACITY kg
F AC 2250 01 99	722x370x35 h	150
With 4 hooks		
The depth of this shelf is suitable for the following containers: size 3A2 / size 3		



size 3A2

size 3

■ This type of shelf can only be used if there is **no centre support**.

■ Containers see page **G28-G30**



size 3A2

size 3

■ This type of shelf can **only** be used when there is a **centre support**.

■ Containers see page **G28-G30**

CENTRE SUPPORT FOR CABINETS

ORD. NO.	REF.
F AC 3100 00 99	A
F AC 3200 00 99	B
F AC 3300 00 99	C

■ The centre support cannot be ordered separately from the cabinet



■ 99

A
For cabinet 450 mm depth and 1000 mm height

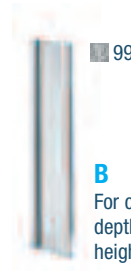

■ 99

B
For cabinet 450 mm depth and 1200 mm height



■ 99

C
For cabinet 450 mm depth and 2000 mm height

UPPER MDF TOP WITH RUBBER OR PVC COVERING DIMENSIONS 1500x450x31,5 mm H

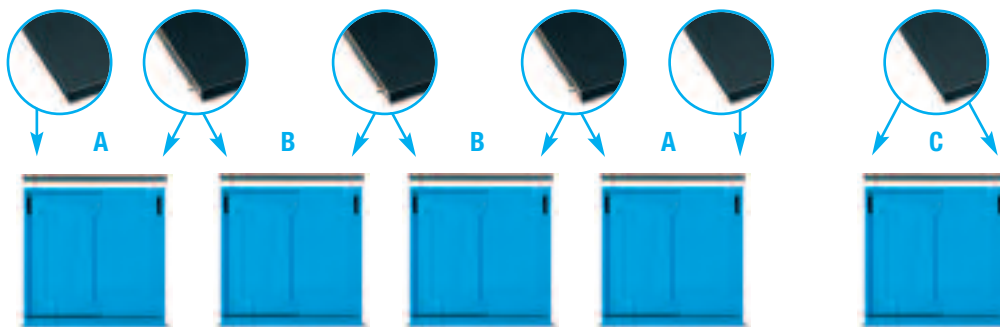

ORD. NO. **F UZ 9998 00 00**

Drilling of the cabinet upper shelf for the MDF top fixing.



Detail of the oil-resistant rubber

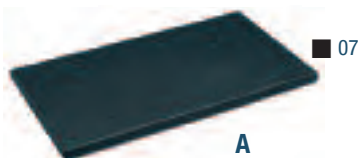

■ 07

A

ORD. NO.
F UZ 3030 11 07
MDF top with rubber covering
Side profile
For end cabinets Oil-resistant rubber mat



■ 07

B

ORD. NO.
F UZ 3030 12 07
MDF top with rubber covering
No side profile
For additional central cabinets Oil-resist. rubber mat

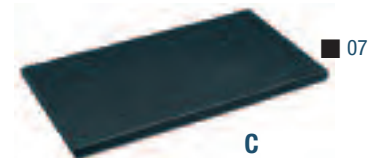

■ 07

C

ORD. NO.
F UZ 3030 13 07
MDF top with rubber covering
2 side profiles
For single cabinet Oil-resistant rubber mat

■ KEY

RAL 7000 F.01

RAL 6011 F.02

RAL 5012 F.04

RAL 7035 F.08



■ All indicated loads are net and refer to evenly distributed weights



CABINETS SERIES PERFORM A300

ORD. NO. F AB 3300 03 08
 RAL 7035

ORD. NO. F AB 3200 02 01
 RAL 7000

ORD. NO. F AB 3100 02 04
 RAL 5012

FLOOR FIXING SET



2x

- 2 "HILTI" plugs for concrete floors ≥ to classes B25/RBK250/MPA 25 N/mm²
- Recommended traction of the plug: 2.9 KN
- Plug diameter: Ø 6 mm

ORD. NO. F AG 9204 00 99

CABINET
ORD. NO.

F AB 3100 02 04

Complete with:
 2 galvanised adjustable shelves

Dim. mm 1023x450x1000 h

Tools excluded

CABINET
ORD. NO.

F AB 3200 02 01

Complete with:
 2 galvanised adjustable shelves

Dim. mm 1023x450x1200 h

Tools excluded

CABINET
ORD. NO.

F AB 3300 03 08

Complete with:
 5 galvanised adjustable shelves

Dim. mm 1023x450x2000 h

Tools excluded

RAL 7000 F.01 RAL 6011 F.02 RAL 5012 F.04 RAL 7035 F.08

SUPPLEMENTARY PARTS ■

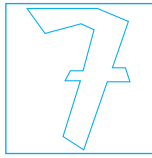

- **Spare key.** Always indicate the number on the cylinder lock of the key to be replaced.
 ORD. NO. R CSC 0002 00
- **Master key.** This type of key opens all the 45 and 46 series locks.
 ORD. NO. R CSC 0001 00



LENGTH = 1023 mm DEPTH = 450 mm

CABINETS SERIES PERFORM A300



ORD. NO.	SHELVES
F AB 3100 01 04	1
Cabinet with 1 shelf depth 370 mm load capacity 100 kg	
Cabinet load capacity: 600 kg	
Dimensions mm 1023x450x1000 h	



ORD. NO.	SHELVES
F AB 3100 02 04	2
Cabinet with 2 shelves depth 370 mm load capacity 100 kg	
Cabinet load capacity: 600 kg	
Dimensions mm 1023x450x1000 h	



ORD. NO.	SHELVES
F AB 3100 04 04	3
Cabinet with 3 shelves depth 370 mm load capacity 100 kg	
Cabinet load capacity: 600 kg	
Dimensions mm 1023x450x1000 h	



ORD. NO.	SHELVES
F AB 3200 02 04	2
Cabinet with 2 shelves depth 370 mm load capacity 100 kg	
Cabinet load capacity: 600 kg	
Dimensions mm 1023x450x1200 h	



ORD. NO.	SHELVES
F AB 3200 04 04	3
Cabinet with 3 shelves depth 370 mm load capacity 100 kg	
Cabinet load capacity: 600 kg	
Dimensions mm 1023x450x1200 h	

ORD. NO. F AB 3100 54 04
Including: 1 cabinet ORD. NO. F AB 3100 04 04
8 size 3 blue containers, 8 size 3A2 blue containers

■ We suggest to secure the cabinet to the floor or to the wall

■ Top shelf load capacity 80 kg

■ The cabinet must be fixed to the floor or to the wall



ORD. NO.	SHELVES
F AB 3300 01 04	4
Cabinet with 4 shelves depth 370 mm load capacity 100 kg	
Cabinet load capacity: 800 kg	
Dimensions mm 1023x450x2000 h	



ORD. NO.	SHELVES
F AB 3300 03 04	5
Cabinet with 5 shelves depth 370 mm load capacity 100 kg	
Cabinet load capacity: 800 kg	
Dimensions mm 1023x450x2000 h	

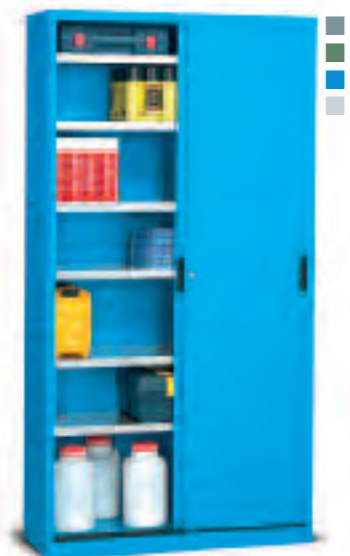

ORD. NO.	SHELVES
F AB 3300 04 04	6
Cabinet with 6 shelves depth 370 mm load capacity 100 kg	
Cabinet load capacity: 800 kg	
Dimensions mm 1023x450x2000 h	

CABINETS SERIES PERFORM A300

EMPTY CABINET WITH DOORS



- 01
- 02
- 04
- 08

ORD. NO.

F AB 3100 00 04

Cabinet load capacity: 600 kg

Dimensions mm 1023x450x1000 h

Internal dimensions mm 995x370x850 h

The F AB 3100 series cabinets are supplied as standard with 2 floor fixing brackets, 2 wall fixing brackets and 2 levelling devices.

■ Fixing cabinets series F AB 3100 / F AB 3200

The cabinet should be fixed to the floor or to the wall. If the cabinets are placed on the top of the other, they must be secured to the wall.

EMPTY CABINET WITH DOORS



- 01
- 02
- 04
- 08

ORD. NO.

F AB 3200 00 04

Cabinet load capacity: 600 kg

Dimensions mm 1023x450x1200 h

Internal dimensions mm 995x370x1050 h

The F AB 3200 series cabinets are supplied as standard with 2 floor fixing brackets, 2 wall fixing brackets and 2 levelling devices.

■ Fixing cabinets series F AB 3300

The cabinet must be secured to the floor or to the wall. If the cabinets are placed on the top of the other, they must be secured to the wall.

EMPTY CABINET WITH DOORS



- 01
- 02
- 04
- 08

ORD. NO.

F AB 3300 00 04

Cabinet load capacity: 800 kg

Dimensions mm 1023x450x2000 h

Internal dimensions mm 995x370x1850 h

The F AB 3300 series cabinets are supplied as standard with 2 floor fixing brackets, 2 wall fixing brackets and 2 levelling devices.

TOP SHELF WITH 3 EDGES



■ 07

ORD. NO.

F AC 4150 01 07

Dimensions mm 1023x450x20 h

For cabinet F AB 3100 / 3200 ...

■ Oil-resistant rubber



ADJUSTABLE SHELF DEPTH 370 mm



■ 99

ORD. NO.

STRENGTH. BAR LOAD CAPACITY

F AC 2450 01 99 0 100 kg

F AC 2450 03 99 1 150 kg

With 4 hooks

The depth of this shelf is suitable for the following containers: size 3A2/size 3.

Dimensions mm 995x370x35 h



■ Containers see page G28-G30

■ This type of shelf can be assembled only if the perforated back panel is not fitted.

UPPER MDF TOP WITH RUBBER OR PVC COVERING DIMENSIONS 1023x450x31,5 mm H

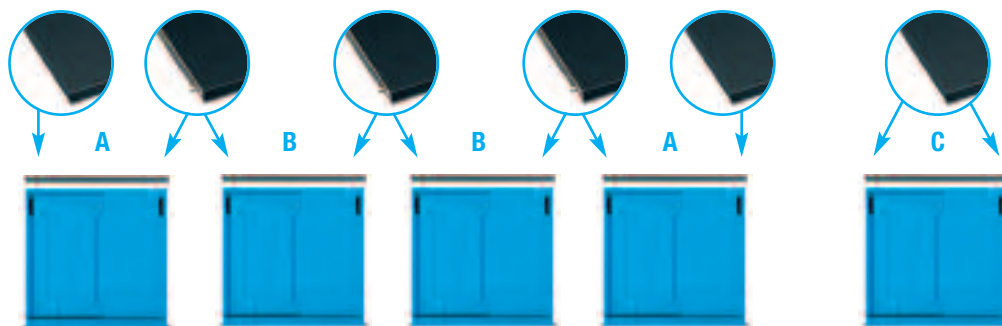

ORD. NO. F UZ 9999 00 00

Drilling of the cabinet upper shelf for the MDF top fixing.



Detail of the oil-resistant rubber

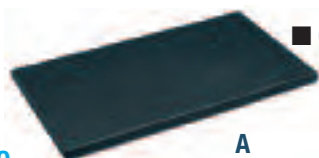

■ 07

A

ORD. NO.

F UZ 3010 11 07

MDF top with rubber covering

Side profile

For end cabinets

Oil-resistant rubber



■ 07

B

ORD. NO.

F UZ 3010 12 07

MDF top with rubber covering

No side profile

For additional central cabinets

Oil-resistant rubber



■ 07

C

ORD. NO.

F UZ 3010 13 07

MDF top with rubber covering

2 side profiles

For single cabinet

Oil-resistant rubber

LENGTH = 1023 mm DEPTH = 450

CABINETS SERIES PERFORM A300

PERFORATED PANEL

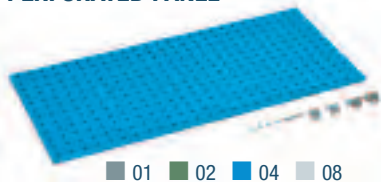

■ 01 ■ 02 ■ 04 ■ 08

■ This type of panel is fitted inside the cabinet by means of 4 brackets complete of screws. A maximum of 4 panels can be fitted in height.

■ Hooks see page C66

ORD. NO.

LOAD CAPACITY kg

F AC 8100 01 04

25

Dimensions mm 988x13x456 h

With 4 brackets, 4 screws and 4 washers

EXAMPLE INCLUDING:

ORD. NO.

F AB 3300 S1 51

1 cabinet without doors ORD. NO. F AB 3301 00 04 with 6 adjustable shelves

1 pair of sliding doors ORD. NO. F AC 0150 00 01

16 size 3 blue containers ORD. NO. F PM 4151 00 04

12 size 3 grey containers ORD. NO. F PM 4151 00 01

Dimensions mm 1023x450x2000 h



■ RAL 5012 + ■ RAL 7000

EXAMPLE INCLUDING:

ORD. NO.

F AB ZA04 00 08

1 cabinet ORD. NO. F AB 3300 00 08 with 3 adjust. shelves, 2 perforated panels, 1 set of 41 hooks (tools are excluded) and 12 size 3 blue containers,

2 cabinets ORD. NO. F AB 3200 00 08 with 2 adjustable shelves each,

2 upper shelves ORD. NO. F UZ 3010 11 07

Dimensions mm 3069x450x2000 h

Tools excluded



■ RAL 7035

CABINETS SERIES PERFORM A800

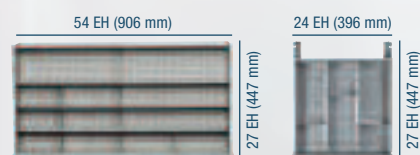
ORD. NO. F AB 8302 03 01
RAL 7000ORD. NO. F AB 8100 08 08
RAL 7035

FLOOR FIXING SET



2x

- 2 "HILTI" plugs for concrete floors \geq to classes B25/RBK250/MP_A 25 N/mm²
- Recommended traction of the plug: 2.9 KN
- Plug diameter: \varnothing 6 mm

ORD. NO. F AG 9204 00 99

CABINET

ORD. NO.

F AB 8100 08 08

Cabinet with 2 galvanised adjustable shelves

2 normal extension drawers

1 centre support

Dimensions mm 2046x600x1000 h

CABINET

ORD. NO.

F AB 8302 03 01

Cabinet with 2 perforated panels

6 galvanised adjustable shelves

3 normal extension drawers

1 centre support

Dimensions mm 2046x600x2000 h

Tools and storage containers excluded

RAL 7000 F.01 RAL 6011 F.02 RAL 5012 F.04 RAL 7035 F.08

SUPPLEMENTARY PARTS ■

- **Spare key.** Always indicate the number on the cylinder lock of the key to be replaced.

ORD. NO. R CSC 0002 00

- **Master key.** This type of key opens all the 45 and 46 series locks.

ORD. NO. R CSC 0001 00



LENGTH = 2046 mm DEPTH = 600 mm (54x27 Eh / 24x27 Eh)

CABINETS SERIES PERFORM A800



ORD. NO.	DRAWERS
F AB 8100 02 04	4
Cabinet with 2 shelves depth 500 mm load capacity 100 kg	
2 pair of normal extension drawers load capacity 50 kg	
1 centre support	
Cabinet load capacity: 600 kg per compartment	
Dimensions mm 2046x600x1000 h	



ORD. NO.	DRAWERS
F AB 8100 08 04	2
Cabinet with 2 shelves depth 500 mm load capacity 100 kg	
2 normal extension drawers load capacity 50 kg	
1 centre support	
Cabinet load capacity: 600 kg per compartment	
Dimensions mm 2046x600x1000 h	



ORD. NO.	DRAWERS
F AB 8100 09 04	2
Cabinet with 4 shelves depth 500 mm load capacity 100 kg	
2 normal extension drawers load capacity 50 kg	
1 centre support	
Cabinet load capacity: 600 kg per compartment	
Dimensions mm 2046x600x1000 h	



ORD. NO.	SHELVES
F AB 8100 10 04	2
Cabinet with 2 shelves depth 500 mm load capacity 100 kg	
1 centre support	
Cabinet load capacity: 600 kg per compartment	
Dimensions mm 2046x600x1000 h	



ORD. NO.	SHELVES
F AB 8100 11 04	4
Cabinet with 4 shelves depth 500 mm load capacity 100 kg	
1 centre support	
Cabinet load capacity: 600 kg per compartment	
Dimensions mm 2046x600x1000 h	

KEY



- If the cabinet is with drawers it must be fixed to the floor or to the wall
- Top shelf load capacity 80 kg
- Normal extension (87%)
- All indicated loads are net and refer to evenly distributed weights

RAL 7000 F.01 RAL 6011 F.02 RAL 5012 F.04 RAL 7035 F.08

■ Partitioning material see page A224-A225



CABINETS SERIES PERFORM A800



ORD. NO.

SHELVES

F AB 8300 01 04**8**

Cabinet with 8 shelves depth 500 mm load capacity 100 kg

1 centre support

Cabinet load capacity: 800 kg per compartment

Dimensions mm 2046x600x2000 h



ORD. NO.

DRAWERS

F AB 8300 02 04**4**

Cabinet with 4 shelves depth 500 mm load capacity 100 kg

4 normal extension drawers load capacity 50 kg, 1 centre support

Cabinet load capacity: 800 kg per compartment

Dimensions mm 2046x600x2000 h



ORD. NO.

DRAWERS

F AB 8300 09 04**6**

Cabinet with 8 shelves depth 500 mm load capacity 100 kg

6 normal extension drawers load capacity 50 kg, 1 centre support

Cabinet load capacity: 800 kg per compartment

Dimensions mm 2046x600x2000 h



ORD. NO.

SHELVES

F AB 8302 01 04**4**

Cabinet with 8 shelves depth 500 mm load capacity 100 kg

1 centre support

Cabinet load capacity: 800 kg per compartment

Dimensions mm 2046x600x2000 h

RAL 7000 F.01 RAL 6011 F.02 RAL 5012 F.04 RAL 7035 F.08

KEY ■



■ Partitioning material see page A224-A225

- The cabinets must be secured to the floor or to the wall
- 4 mm thickness polycarbonate doors
- Top shelf load capacity 80 kg
- Normal extension (87%)
- All indicated loads are net and refer to evenly distributed weights



LENGTH = 2046 mm DEPTH = 600 mm (54x27 Eh / 24x27 Eh)

CABINETS SERIES PERFORM A800

EMPTY CABINET WITH DOORS AND CENTRE SUPPORT



- 01
- 02
- 04
- 08

■ The drawers in the cabinet have a maximum load capacity of 350 kg regardless of the load capacity of the cabinets.

■ **Fixing cabinets series F AB 8100**
If one or more drawers are fitted, the cabinets must be secured to the floor or to the wall. If the cabinets are placed on the top of the other, they must be secured to the wall.

■ **Fixing cabinets series F AB 8300 / F AB 8302**
The cabinets must be secured to the floor or to the wall. If the cabinets are placed on the top of the other, they must be secured to the wall.

ORD. NO.

F AB 8100 01 04

Cabinet load capacity: 600 kg per compartment

Dimensions mm 2046x600x1000 h

Internal dimensions of each compartment mm 995x500x850 h

The F AB 8100 series cabinets are supplied as standard with 2 floor fixing brackets, 2 wall fixing brackets and 2 levelling devices.

EMPTY CABINET WITH DOORS AND CENTRE SUPPORT



- 01
- 02
- 04
- 08

EMPTY CABINET WITH DOORS AND CENTRE SUPPORT



- 01
- 02
- 04
- 08

ORD. NO.

F AB 8300 00 04

Cabinet load capacity: 800 kg per compartment

Dimensions mm 2046x600x2000 h

Internal dimensions of each compartment mm 995x500x1850 h

The F AB 8300 series cabinets are supplied as standard with 4 floor fixing brackets, 4 wall fixing brackets and 4 levelling devices.

ORD. NO.

F AB 8302 00 04

Cabinet load capacity: 800 kg per compartment

Dimensions mm 2046x600x2000 h

Internal dimensions of each compartment mm 995x500x1850 h

The F AB 8302 series cabinets are supplied as standard with 4 floor fixing brackets, 4 wall fixing brackets and 4 levelling devices.

FULL EXTENSION SUSPENSION FOLDER FRAME FOR SUSPENSION FOLDER DIN A4

ORD. NO.

F AC 7500 00 07

The suspension folder frames are supplied with telescopic extension guide rails (100% extension) with 30 kg load capacity.

Overall dimensions: 990x500 mm

For suspension folders DIN A4

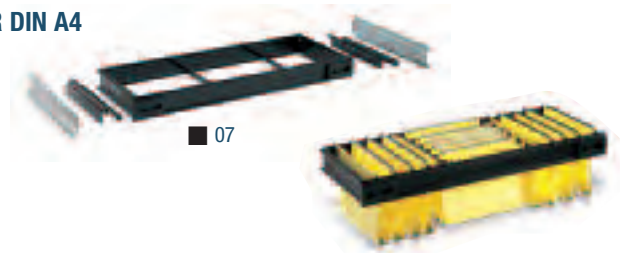

- 07

■ KEY

- RAL 7000 F.01
- RAL 6011 F.02
- RAL 5012 F.04
- RAL 7035 F.08



- 4 mm thickness polycarbonate doors
- Top shelf load capacity 80 kg
- All indicated loads are net and refer to evenly distributed weights

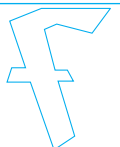

CABINETS SERIES PERFORM A800

TOP SHELF WITH 3 EDGES

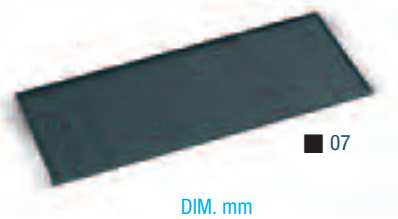

ORD. NO.

DIM. mm

F AC 4500 01 07

2046x600x20 h

For cabinet F AB 8100



■ Oil-resistant rubber

ADJUSTABLE SHELF DEPTH 500 mm



ORD. NO.

DIM. mm

STRENGTH. BAR LOAD CAPACITY kg

F AC 2500 01 99

995x500x35 h

0

100

F AC 2500 03 99

995x500x35 h

1

180

Complete with 4 hooks

The depth of this shelf is suitable for the following containers:
size 4A2 / size 4 / size 4A5

■ This type of shelf can be assembled only if the **perforated back panel is not fitted**.

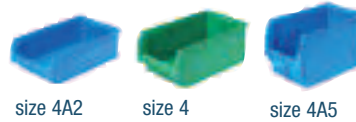

■ Containers see page **G28-G30**

ADJUSTABLE SHELF DEPTH 480 mm



ORD. NO.

DIM. mm

LOAD CAPACITY kg

F AC 2480 07 99

995x480x35 h

50

Complete with 2 guide rails

The depth of this shelf is suitable for the following containers:
size 4A2 / size 4 / size 4A5

■ This type of shelf **can** be fitted even in the presence of the **perforated back panel**.

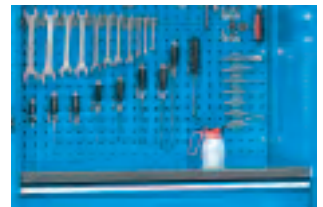
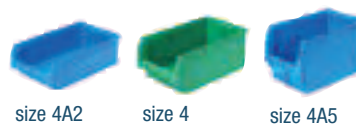

■ Containers see page **G28-G30**

PERFORATED PANEL



ORD. NO.

DIM. mm

LOAD CAPACITY kg

F AC 8100 01 04

988x13x456 h

25

Complete with 4 brackets, 4 screws and 4 washers

Not suitable for doors

■ This type of panel is fitted inside the cabinet by means of 4 brackets complete of screws. A maximum of 4 panels can be fitted in the height.

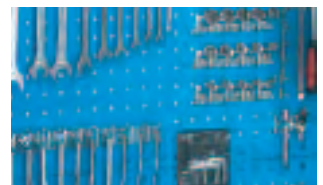

■ Hooks see page **C66**

RAL 7000 F.01 RAL 6011 F.02 RAL 5012 F.04 RAL 7035 F.08

KEY ■

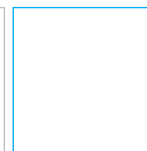
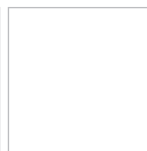
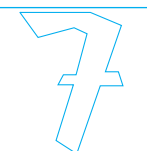

■ All indicated loads are net and refer to evenly distributed weights



LENGTH = 2046 mm DEPTH = 600 mm (54x27 Eh / 24x27 Eh)

CABINETS SERIES PERFORM A800

NORMAL AND FULL EXTENSION DRAWERS 54x27 EH



ORD. NO.	EXTENSION
F AC 1200 00 04	NORMAL
F AC 1250 00 04	TELESCOPIC
Normal extension drawer load capacity: 50 kg	
Full extension drawer load capacity: 100 kg	
Internal dimensions mm 906x447x85 h	

PAIR OF NORMAL AND FULL EXTENSION DRAWERS 24x27 EH

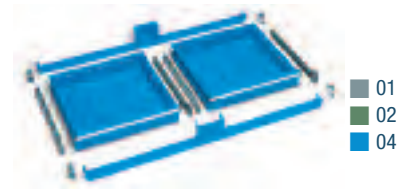

ORD. NO.	EXTENSION
F AC 1600 00 04	NORMAL
F AC 1650 00 04	TELESCOPIC
Normal extension drawer load capacity: 50 kg	
Full extension drawer load capacity: 60 kg	
Internal dimensions mm 396x447x85 h (each drawer)	

UPPER MDF TOP WITH RUBBER OR PVC COVERING DIMENSIONS 2046x600x31,5 mm H

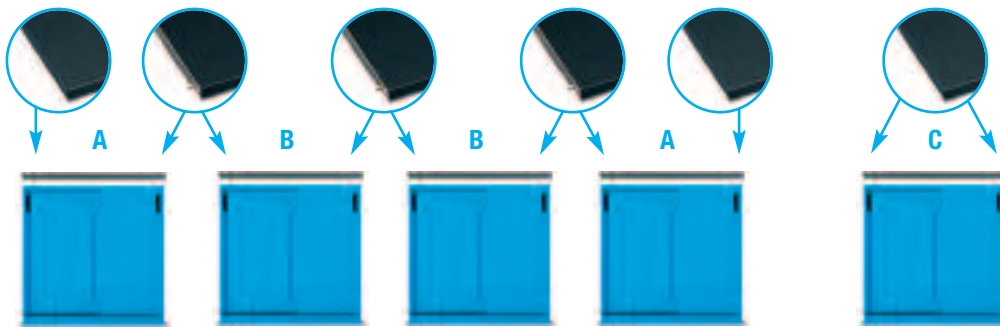

ORD. NO. F UZ 9997 00 00

Drilling of the cabinet upper shelf for the MDF top fixing.



Detail of the oil-resistant rubber

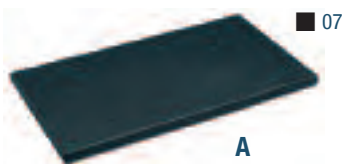

ORD. NO.
F UZ 3170 11 07
MDF top with rubber covering
Side profile
For end cabinets
Oil-resistant rubber



ORD. NO.
F UZ 3170 12 07
MDF top with rubber covering
No side profile
For additional central cabinets
Oil-resistant rubber

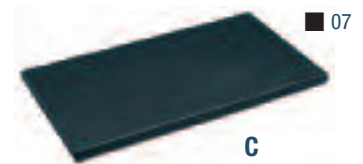

ORD. NO.
F UZ 3170 13 07
MDF top with rubber covering
2 side profiles
For single cabinet
Oil-resistant rubber

KEY



- Normal extension (87%)
- Telescopic extension (100%)
- All indicated loads are net and refer to evenly distributed weights

■ Partitioning material see page A224-A225

RAL 7000 F.01 RAL 6011 F.02 RAL 5012 F.04

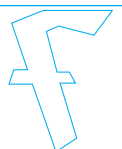



ORD. NO. F AB 6100 06 01
RAL 7000

ORD. NO. F AB 6302 02 08
RAL 7035

FLOOR FIXING SET



2x

- 2 "HILTI" plugs for concrete floors \geq to classes B25/RBK250/MP_A 25 N/mm²
- Recommended traction of the plug: 2.9 KN
- Plug diameter: \varnothing 6 mm

ORD. NO. F AG 9204 00 99

CABINET

ORD. NO.

F AB 6100 06 01

Cabinet with 4 galvanised adjustable shelves
1 centre support

Dimensions mm 1500x600x1000 h

Storage containers excluded

CABINET

ORD. NO.

F AB 6302 02 08

Cabinet with 8 galvanised adjustable shelves
1 centre support

Dimensions mm 1500x600x2000 h

Storage containers excluded

RAL 7000 F.01

RAL 6011 F.02

RAL 5012 F.04

RAL 7035 F.08

SUPPLEMENTARY PARTS ■

- **Spare key.** Always indicate the number on the cylinder lock of the key to be replaced.

ORD. NO. R CSC 0002 00

- **Master key.** This type of key opens all the 45 and 46 series locks.

ORD. NO. R CSC 0001 00



LENGTH = 1500 mm DEPTH = 600 mm

CABINETS SERIES PERFORM A600



ORD. NO.	SHELVES
F AB 6100 02 04	1
Cabinet with 1 shelf depth 500 mm load capacity 100 kg	
Cabinet load capacity: 600 kg	
Dimensions mm 1500x600x1000 h	



ORD. NO.	SHELVES
F AB 6100 03 04	2
Cabinet with 2 shelves depth 500 mm load capacity 100 kg.	
Cabinet load capacity: 600 kg. Dimensions mm 1500x600x1000 h	

ORD. NO. F AB 6100 53 04
Including: 1 cabinet ORD. NO. **F AB 6100 03 04**, 4 size 4A2 blue containers



ORD. NO.	SHELVES
F AB 6100 05 04	2
Cabinet with 2 shelves depth 500 mm load capacity 150 kg, 1 centre support	
Cabinet load capacity: 600 kg. Dimensions mm 1500x600x1000 h	



ORD. NO.	SHELVES
F AB 6100 06 04	4
Cabinet with 4 shelves depth 500 mm load capacity 150 kg, 1 centre support	
Cabinet load capacity: 600 kg	
Dimensions mm 1500x600x1000 h	

ORD. NO. F AB 6100 56 04
Including: 1 cabinet ORD. NO. **F AB 6100 06 04**, 8 size 4 grey containers



■ RAL 7035

EXAMPLE INCLUDING:

ORD. NO.
F AB ZA06 00 08
1 cabinet ORD. NO. F AB 6100 06 08 with 4 adjus. shelves, 1 centre support and 8 size 4 blue containers
1 cabinet ORD. NO. F DF 1090 Z0 08 with lock, 7 drawers and partitioning set
1 cabinet ORD. NO. F DC 1090 Z0 08 with lock, 7 drawers and partitioning set
1 upper shelf ORD. NO. F UZ 3160 11 07
1 upper shelf ORD. NO. F UZ 3120 11 07
1 upper shelf ORD. NO. F UZ 3130 12 07
Dimensions mm 2782x600x1030 h
Tools excluded

■ KEY

■ RAL 7000 F.01 ■ RAL 6011 F.02 ■ RAL 5012 F.04 ■ RAL 7035 F.08



- We suggest to secure the cabinet to the floor or to the wall
- Top shelf load capacity 80 kg
- All indicated loads are net and refer to evenly distributed weights

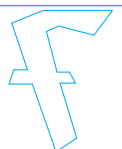

CABINETS SERIES PERFORM A600



ORD. NO.	SHELVES
F AB 6300 02 04	4
Cabinet with 4 shelves depth 500 mm load capacity 100 kg	
Cabinet load capacity: 800 kg	
Dimensions mm 1500x600x2000 h	

ORD. NO.	SHELVES
F AB 6300 03 04	5
Cabinet with 5 shelves depth 500 mm load capacity 100 kg	
Cabinet load capacity: 800 kg	
Dimensions mm 1500x600x2000 h	

ORD. NO. F AB 6300 53 04
Including: 1 cabinet ORD. NO. **F AB 6300 03 04**, 4 size 4A2 blue containers, 8 size 4 grey containers

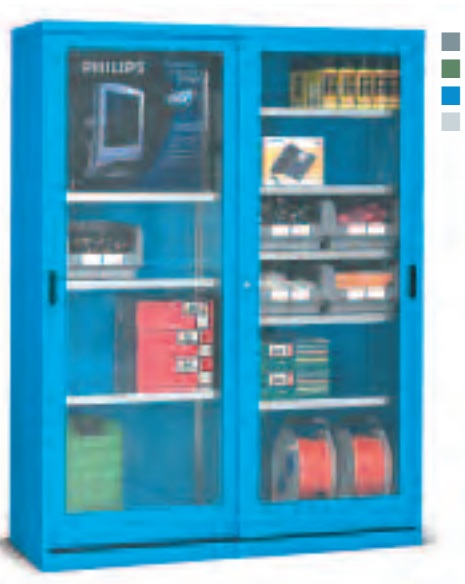

ORD. NO.	SHELVES
F AB 6300 05 04	8
Cabinet with 8 shelves depth 500 mm load capacity 150 kg	
1 centre support	
Cabinet load capacity: 800 kg	
Dimensions mm 1500x600x2000 h	

ORD. NO.	SHELVES
F AB 6302 02 04	8
Cabinet with 8 shelves depth 500 mm load capacity 150 kg, 1 centre support	
Cabinet load capacity: 800 kg	
Dimensions mm 1500x600x2000 h	

ORD. NO. F AB 6302 52 04
Including: 1 cabinet ORD. NO. **F AB 6302 02 04**, 5 size 4 grey containers

RAL 7000 F.01 RAL 6011 F.02 RAL 5012 F.04 RAL 7035 F.08

KEY ■

- The cabinets must be secured to the floor or to the wall
- 3 mm thickness polycarbonate doors
- Top shelf load capacity 80 kg
- All indicated loads are net and refer to evenly distributed weights

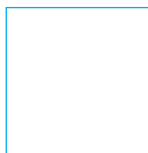
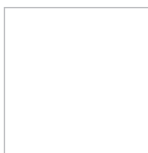
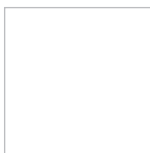
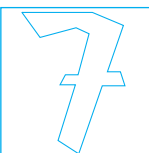

LENGTH = 1500 mm DEPTH = 600 mm

CABINETS SERIES PERFORM A600



■ RAL 7035 + ■ RAL 5012

EXAMPLE INCLUDING:

ORD. NO.

F AB ZA07 00 50

1 cabinet without doors ORD. NO. **F AB 6301 00 08** with 8 adjustable shelves, 1 centre support and 9 size 3 blue containers, 1 pair of doors ORD. NO. **F AC 0255 00 04**

1 cabinet without doors ORD. NO. **F AB 6301 00 08** with 3 adjustable shelves, 1 pair of doors ORD. NO. **F AC 0255 00 04**

Dimensions mm 3000x600x2000 h

Tools excluded

■ **KEY**

■ RAL 7000 F.01 ■ RAL 6011 F.02 ■ RAL 5012 F.04 ■ RAL 7035 F.08



- The cabinets must be secured to the floor or to the wall
- 3 mm thickness polycarbonate doors
- Top shelf load capacity 80 kg



CABINETS SERIES PERFORM A600

EMPTY CABINET WITH DOORS WITHOUT CENTRE SUPPORT



- 01
- 02
- 04
- 08

■ **Fixing cabinets series F AB 6100**
Ideally the cabinet should be fixed to the floor or to the wall. If the cabinets are placed on the top of the other, they must be secured to the wall.

■ **Fixing cabinets series F AB 6300 / F AB 6302**
The cabinets must be secured to the floor or to the wall. If the cabinets are placed on the top of the other, they must be secured to the wall.

ORD. NO.

F AB 6100 00 04

Cabinet load capacity: 600 kg

Dimensions mm 1500x600x1000 h

Internal dimensions mm 1470x500x850 h

The F AB 6100 series cabinets are supplied as standard with 2 floor fixing brackets, 2 wall fixing brackets and 2 levelling devices.

EMPTY CABINET WITH DOORS WITHOUT CENTRE SUPPORT



- 01
- 02
- 04
- 08

ORD. NO.

F AB 6300 00 04

Cabinet load capacity: 800 kg

Dimensions mm 1500x600x2000 h

Internal dimensions mm 1470x500x1850 h

The F AB 6300 series cabinets are supplied as standard with 2 floor fixing brackets, 2 wall fixing brackets and 2 levelling devices.

EMPTY CABINET WITH POLYCARBONATE DOORS WITHOUT CENTRE SUPPORT



- 01
- 02
- 04
- 08

■ 3 mm thickness polycarbonate doors

ORD. NO.

F AB 6302 00 04

Cabinet load capacity: 800 kg

Dimensions mm 1500x600x2000 h

Internal dimensions mm 1470x500x1850 h

The F AB 6302 series cabinets are supplied as standard with 2 floor fixing brackets, 2 wall fixing brackets and 2 levelling devices.

CENTRE SUPPORT FOR CABINET

ORD. NO.

REF.

F AC 3500 00 99

A

F AC 3600 00 99

B

■ The centre support cannot be ordered separately from the cabinet.



■ 99

A
For cabinet 600 mm depth and 1000 mm height



■ 99

B
For cabinet 600 mm depth and 2000 mm height

RAL 7000 F.01 RAL 6011 F.02 RAL 5012 F.04 RAL 7035 F.08

KEY ■

- The cabinets must be secured to the floor or to the wall
- 3 mm thickness polycarbonate doors
- Top shelf load capacity 80 kg
- All indicated loads are net and refer to evenly distributed weights

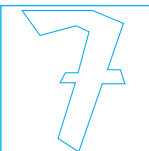

LENGTH = 1500 mm DEPTH = 600 mm

CABINETS SERIES PERFORM A600

ADJUSTABLE SHELF DEPTH 500 mm



ORD. NO. LOAD CAPACITY kg

F AC 2700 01 99 100

Complete with 4 hooks

The depth of this shelf is suitable for the following containers:
size 4A2 / size 4 / size 4A5

Dimensions mm 1470x500x35 h



■ This type of shelf can only be used if there is **no centre support**.

■ Containers see page **G28-G30**

ADJUSTABLE SHELF DEPTH 500 mm



ORD. NO. LOAD CAPACITY kg

F AC 2300 01 99 150

Complete with 4 hooks

The depth of this shelf is suitable for the following containers:
size 4A2 / size 4 / size 4A5

Dimensions mm 722x500x35 h

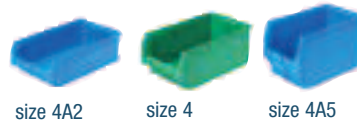

■ This type of shelf can **only** be used when there is a **centre support**.

■ Containers see page **G28-G30**

TOP SHELF WITH 3 EDGES

ORD. NO.

F AC 4400 01 07

Dimensions mm 1500x600x20 h

For cabinet F AB 6100 ...



■ Oil-resistant rubber

UPPER MDF TOP WITH RUBBER OR PVC COVERING DIMENSIONS 1500x600x31,5 mm H

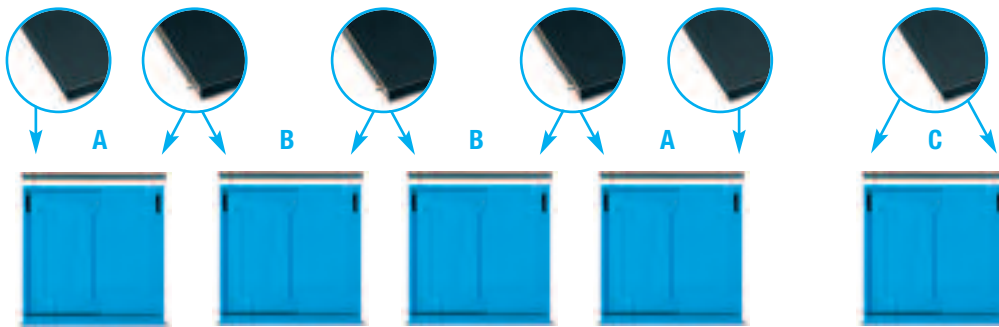

ORD. NO. **F UZ 9998 00 00**

Drilling of the cabinet upper shelf for the MDF top fixing.



Detail of the oil-resistant rubber

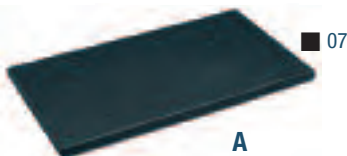

ORD. NO.

F UZ 3160 11 07

MDF top with rubber covering

Side profile

For end cabinets

Oil-resistant rubber



ORD. NO.

F UZ 3160 12 07

MDF top with rubber covering

No side profile

For additional central cabinets

Oil-resistant rubber

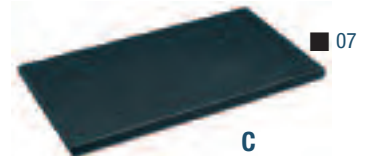

ORD. NO.

F UZ 3160 13 07

MDF top with rubber covering

2 side profiles

For single cabinet

Oil-resistant rubber

■ KEY

RAL 7000 F.01 RAL 6011 F.02 RAL 5012 F.04 RAL 7035 F.08



■ All indicated loads are net and refer to evenly distributed weights

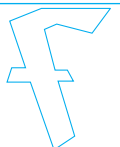

ORD. NO. F AB 4300 02 08
RAL 7035



ORD. NO. F AB 4100 08 01
RAL 7000



FLOOR FIXING SET



2x

- 2 "HILTI" plugs for concrete floors ≥ to classes B25/RBK250/MP_A 25 N/mm²
- Recommended traction of the plug: 2.9 KN
- Plug diameter: Ø 6 mm

ORD. NO. F AG 9204 00 99

CABINET

ORD. NO.

F AB 4100 08 01

Cabinet with 2 galvanised adjustable shelves

1 centre support

Dimensions mm 1023x600x1000 h

CABINET

ORD. NO.

F AB 4300 02 08

Cabinet with 8 galvanised adjustable shelves

1 centre support

Dimensions mm 1023x600x2000 h

Accessories excluded

RAL 7000 F.01

RAL 6011 F.02

RAL 5012 F.04

RAL 7035 F.08

SUPPLEMENTARY PARTS ■

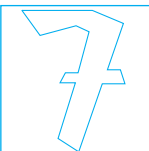

■ **Spare key.** Always indicate the number on the cylinder lock of the key to be replaced.

ORD. NO. R CSC 0002 00

■ **Master key.** This type of key opens all the 45 and 46 series locks.

ORD. NO. R CSC 0001 00



LENGTH = 1023 mm DEPTH = 600 mm (24x27 Eh)

CABINETS SERIES PERFORM A400



ORD. NO. **F AB 4100 02 04**

DRAWERS **2**

Cabinet with 2 shelves depth 500 mm load capacity 100 kg
2 normal extension drawers load capacity 50 kg, 1 centre support
Cabinet load capacity: 600 kg. **Dimensions mm 1023x600x1000 h**



ORD. NO. **F AB 4100 03 04**

DRAWERS **2**

Cabinet with 4 shelves depth 500 mm load capacity 100 kg
2 normal extension drawers load capacity 50 kg, 1 centre support
Cabinet load capacity: 600 kg. **Dimensions mm 1023x600x1000 h**



ORD. NO. **F AB 4100 07 04**

SHELVES **1**

Cabinet with 1 shelf depth 500 mm load capacity 100 kg, **without** centre support
Cabinet load capacity: 600 kg. **Dimensions mm 1023x600x1000 h**



ORD. NO. **F AB 4100 08 04**

SHELVES **2**

Cabinet with 2 shelves depth 500 mm load capacity 100 kg, **without** centre support
Cabinet load capacity: 600 kg. **Dimensions mm 1023x600x1000 h**



EXAMPLE INCLUDING:

■ RAL 5012 + ■ RAL 7035

ORD. NO.

F AB ZA09 00 50

1 cabinet without doors ORD. NO. **F AB 4101 00 08** with 2 adjustable shelves, 1 pair of sliding doors ORD. NO. **F AC 0110 00 04**
1 cabinet without doors ORD. NO. **F AB 4101 01 08** with 1 centre support, 1 pair of sliding doors ORD. NO. **F AC 0110 00 04**, 8 normal ext. drawers ORD. NO. **F AC 1100 00 04** with 6 partitioning set, 8 full extension drawers ORD. NO. **F AC 1150 00 04** with 6 partitioning set
1 cabinet with doors ORD. NO. **F AB 4150 01 50** with 2 adjustable shelves, 1 cabinet with doors ORD. NO. **F AB 4140 01 50** with 2 adjustable shelves
1 cabinet without doors ORD. NO. **F AB 4301 00 08** with 4 adjustable shelves, 1 pair of sliding doors ORD. NO. **F AC 0150 00 04**, 4 perforated panels ORD. NO. **F BL 1220 00 04**
1 set of 95 hooks ORD. NO. **F BL 9517 00 99** (tools are excluded), 2 upper shelves ORD. NO. **F UZ 3140 11 07**
Dimensions mm 4092x600x2000 h

CABINETS SERIES PERFORM A400

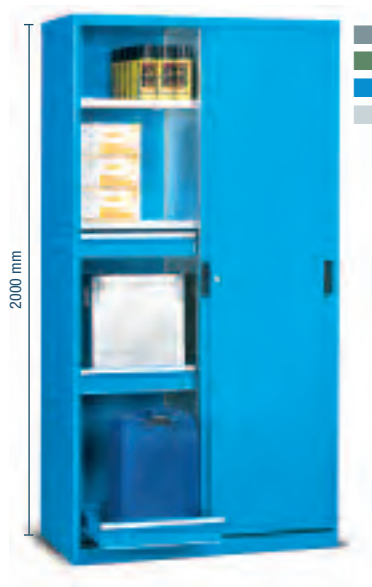

ORD. NO.

DRAWERS

F AB 4300 03 04**4**

Cabinet with 4 shelves depth 500 mm load capacity 100 kg

6 normal extension drawers load capacity 50 kg

1 centre support

Cabinet load capacity: 800 kg

Dimensions mm 1023x600x2000 h



ORD. NO.

DRAWERS

F AB 4300 09 04**4**

Cabinet with 8 shelves depth 500 mm load capacity 100 kg

4 normal extension drawers load capacity 50 kg

1 centre support

Cabinet load capacity: 800 kg

Dimensions mm 1023x600x2000 h



ORD. NO.

SHELVES

F AB 4300 11 04**4**

Cabinet with 4 shelves depth 500 mm load capacity 100 kg

Without centre support

Cabinet load capacity: 800 kg

Dimensions mm 1023x600x2000 h



ORD. NO.

SHELVES

F AB 4300 12 04**5**

Cabinet with 5 shelves depth 500 mm load capacity 100 kg

Without centre support

Cabinet load capacity: 800 kg

Dimensions mm 1023x600x2000 h

RAL 7000 F.01

RAL 6011 F.02

RAL 5012 F.04

RAL 7035 F.08

KEY ■

■ Partitioning material see page **A224-A225**

- The cabinets must be secured to the floor or to the wall
- Top shelf load capacity 80 kg
- Normal extension (87%)
- Telescopic extension (100%)
- All indicated loads are net and refer to evenly distributed weights



LENGTH = 1023 mm DEPTH = 600 mm (24x27 Eh)

CABINETS SERIES PERFORM A400

EMPTY CABINET WITH DOORS WITHOUT CENTRE SUPPORT



ORD. NO.

F AB 4100 00 04

Cabinet load capacity: 600 kg

Dimensions mm 1023x600x1000 h

Internal dimensions mm 995x500x850 h

The F AB 4100 series cabinets are supplied as standard with 2 floor fixing brackets, 2 wall fixing brackets and 2 levelling devices.



■ The drawers in the cabinet have a maximum load capacity of 350 kg regardless of the load capacity of the cabinets.

■ **Fixing cabinets series F AB 4100**

If one or more drawers are fitted, the cabinets must be secured to the floor or to the wall. If the cabinets are placed on the top of the other, they must be secured to the wall.

■ **Fixing cabinets series F AB 8300 / F AB 8302**

The cabinets must be secured to the floor or to the wall. If the cabinets are placed on the top of the other, they must be secured to the wall.

EMPTY CABINET WITH DOORS WITHOUT CENTRE SUPPORT



ORD. NO.

F AB 4300 00 04

Cabinet load capacity: 800 kg

Dimensions mm 1023x600x2000 h

Internal dimensions mm 995x500x1850 h

The F AB 4300 series cabinets are supplied as standard with 2 floor fixing brackets, 2 wall fixing brackets and 2 levelling devices.

CENTRE SUPPORT FOR CABINET

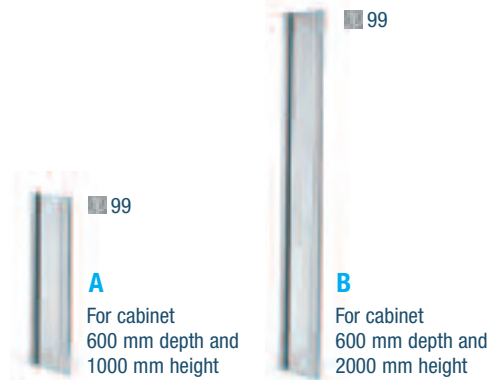

ORD. NO.

REF.

F AC 3150 00 99

A

F AC 3350 00 99

B

■ The centre support cannot be ordered separately from the cabinet.

TOP SHELF WITH 3 EDGES

ORD. NO.

F AC 4250 01 07

Dimensions mm 1023x600x20 h

For cabinet F AB 4100 ...



■ Oil-resistant rubber

■ KEY

RAL 7000 F.01 RAL 6011 F.02 RAL 5012 F.04 RAL 7035 F.08



- The cabinets must be secured to the floor or to the wall
- Top shelf load capacity 80 kg
- All indicated loads are net and refer to evenly distributed weights

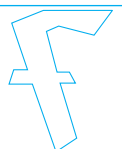

CABINETS SERIES PERFORM A400

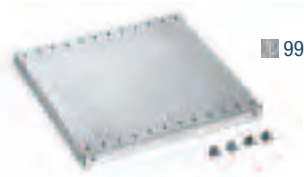

ADJUSTABLE SHELF
DEPTH 500 mm

ORD. NO.	DIM. mm	LOAD CAPACITY kg
F AC 2100 01 99	483x500x35 h	100

Complete with 4 hooks

The depth of this shelf is suitable for the following containers:
size 4A2 / size 4 / size 4A5

■ This type of shelf can **only** be used when there is a **centre support**.

■ Containers see page **G28-G30**



ADJUSTABLE SHELF
DEPTH 500 mm

ORD. NO.	DIM. mm	STRENGTH. BAR	LOAD CAPACITY kg
F AC 2500 01 99	995x500x35 h	0	100
F AC 2500 03 99	995x500x35 h	1	180

Complete with 4 hooks

The depth of this shelf is suitable for the following containers:
size 4A2 / size 4 / size 4A5

■ This type of shelf can **only** be used if there is **no centre support** and **no perforated back panel**.

■ Containers see page **G28-G30**



ADJUSTABLE SHELF
DEPTH 480 mm

ORD. NO.	DIM. mm	LOAD CAPACITY kg
F AC 2480 07 99	995x480x35 h	50

Complete with 2 guide rails

The depth of this shelf is suitable for the following containers:
size 4A2 / size 4 / size 4A5

■ This type of shelf **can** be fitted even in the presence of the **perforated back panel without centre support**.

■ Containers see page **G28-G30**

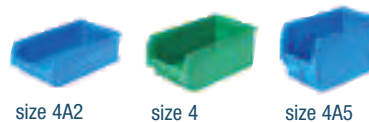

PERFORATED PANEL

ORD. NO.	DIM. mm	LOAD CAPACITY kg
F AC 8100 01 04	988x13x456 h	25

Complete with 4 brackets, 4 screws and 4 washers

Not suitable for doors

■ This type of panel is fitted inside the cabinet by means of 4 brackets complete of screws. A maximum of 4 panels can be fitted in height.

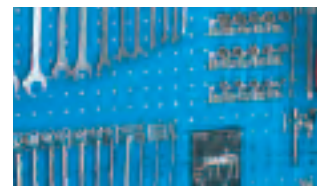

■ Hooks see page **C66**

RAL 7000 F.01 RAL 6011 F.02 RAL 5012 F.04 RAL 7035 F.08

KEY ■



■ All indicated loads are net and refer to evenly distributed weights



LENGTH = 1023 mm DEPTH = 600 mm (24x27 Eh)

CABINETS SERIES PERFORM A400

NORMAL AND FULL EXTENSION DRAWERS 24x27 EH



ORD. NO.	EXTENSION
F AC 1100 00 04	NORMAL
F AC 1150 00 04	TELESCOPIC
Normal extension drawer load capacity: 50 kg	
Full extension drawer load capacity: 100 kg	
Internal dimensions mm 396x447x85 h	

PAIR OF NORMAL AND FULL EXTENSION DRAWERS 24x27 EH

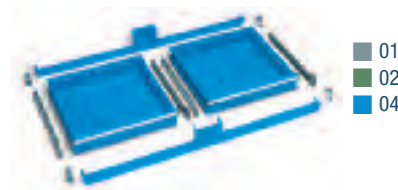

ORD. NO.	EXTENSION
F AC 1600 00 04	NORMAL
F AC 1650 00 04	TELESCOPIC
Normal extension drawer load capacity: 50 kg	
Full extension drawer load capacity: 60 kg	
Internal dimensions mm 396x447x85 h (for each drawer)	

UPPER MDF TOP WITH RUBBER OR PVC COVERING DIMENSIONS 1023x600x31,5 mm H

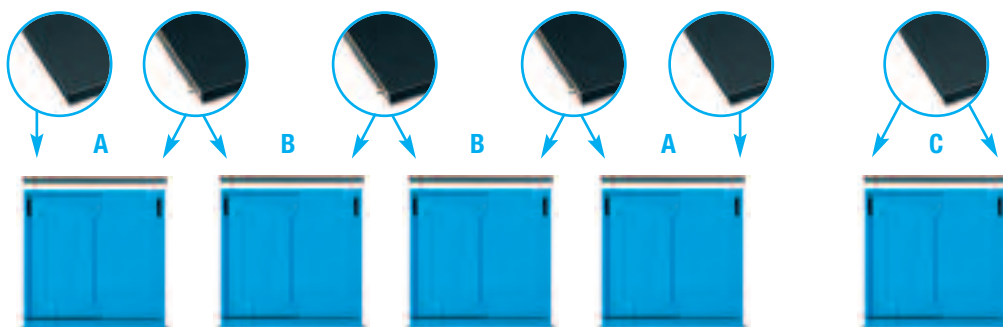

ORD. NO. F UZ 9999 00 00

Drilling of the cabinet upper shelf for the MDF top fixing.



Detail of the oil-resistant rubber

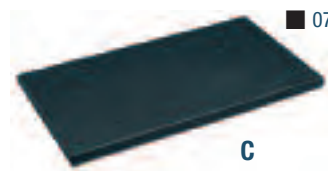
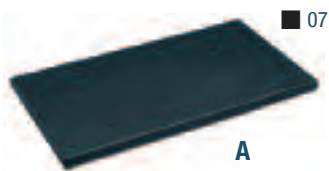

ORD. NO.
F UZ 3140 11 07
MDF top with rubber covering
Side profile
For end cabinets
Oil-resistant rubber

ORD. NO.
F UZ 3140 12 07
MDF top with rubber covering
No side profile
For additional central cabinets
Oil-resistant rubber

ORD. NO.
F UZ 3140 13 07
MDF top with rubber covering
2 side profiles
For single cabinet
Oil-resistant rubber

KEY



- Normal extension (87%)
- Telescopic extension (100%)
- All indicated loads are net and refer to evenly distributed weights

■ Partitioning material see page A224-A225

RAL 7000 F.01 RAL 6011 F.02 RAL 5012 F.04



CABINETS SERIES PERFORM 1200



ORD. NO. F AK 2080 53 04
RAL 5012

ORD. NO. F AK 1066 54 08
RAL 7035

ORD. NO. F AK 2040 52 08
RAL 7035

FLOOR FIXING SET



2x

- 2 "HILTI" plugs for concrete floors \geq to classes B25/RBK250/MPa 25 N/mm²
- Recommended traction of the plug: 2.9 KN
- Plug diameter: \varnothing 6 mm

ORD. NO. F AG 9204 00 99

CABINET

ORD. NO.

F AK 2040 52 08

Complete with:

- 6 shelves depth 235 mm (50 kg)
- 4 back plinths for containers
- 24 size 1 blue containers
- 12 size 2 grey containers

Dim. mm 700x270x1000 h

CABINET

ORD. NO.

F AK 1066 54 08

Complete with:

- 12 shelves depth 235 mm (50 kg)
- 7 back plinths for containers
- 42 size 1 blue containers
- 24 size 2 grey containers

Dim. mm 700x270x1655 h

CABINET

ORD. NO.

F AK 2080 53 04

Complete with:

- 12 shelves depth 235 mm (50 kg)
- 52 size 2 grey containers

Dim. mm 700x270x2000 h

RAL 7000 F.01

RAL 6011 F.02

RAL 5012 F.04

RAL 7035 F.08

SUPPLEMENTARY PARTS ■

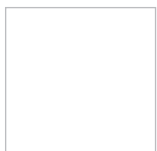
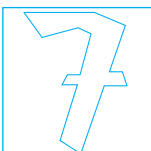

- **Spare key.** Always indicate the number on the cylinder lock of the key to be replaced.

ORD. NO. R CSC 0002 00

- **Master key.** This type of key opens all the 45 and 46 series locks.

ORD. NO. R CSC 0001 00



LENGTH = 700 mm DEPTH = 270 mm

CABINETS SERIES PERFORM 1200

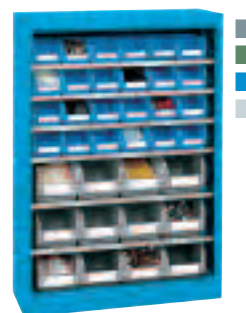
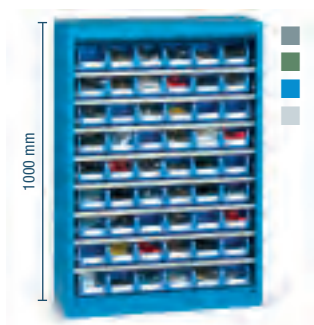

ORD. NO.	SHELVES
F AK 2040 51 04	8
Cabinet with 8 shelves depth 235 mm load capacity 50 kg	
9 back plinths for containers, 54 size 1 blue containers	
Cabinet load capacity: 450 kg	
Dimensions mm 700x270x1000 h	

ORD. NO.	SHELVES
F AK 2040 52 04	6
Cabinet with 6 shelves depth 235 mm load capacity 50 kg	
4 back plinths for cont., 24 size 1 blue containers, 12 size 2 grey containers	
Cabinet load capacity: 450 kg	
Dimensions mm 700x270x1000 h	

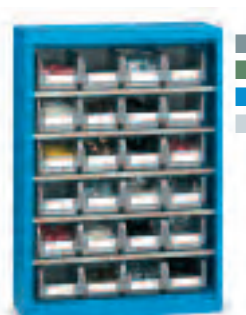

ORD. NO.	SHELVES
F AK 1040 51 04	8
Cabinet with 8 shelves depth 235 mm load capacity 50 kg	
9 back plinths for containers, 54 size 1 blue containers	
Cabinet load capacity: 450 kg	
Dimensions mm 700x270x1000 h	

ORD. NO.	SHELVES
F AK 2040 53 04	5
Cabinet with 5 shelves depth 235 mm load capacity 50 kg	
24 size 2 grey containers	
Cabinet load capacity: 450 kg	
Dimensions mm 700x270x1000 h	



ORD. NO.	SHELVES
F AK 1040 53 04	5
Cabinet with 5 shelves depth 235 mm load capacity 50 kg	
24 size 2 grey containers	
Cabinet load capacity: 450 kg	
Dimensions mm 700x270x1000 h	

ORD. NO.	SHELVES
F AK 1040 52 04	6
Cabinet with 6 shelves depth 235 mm load capacity 50 kg	
4 back plinths for cont., 24 size 1 blue containers, 12 size 2 grey containers	
Cabinet load capacity: 450 kg	
Dimensions mm 700x270x1000 h	

KEY

RAL 7000 F.01 RAL 6011 F.02 RAL 5012 F.04 RAL 7035 F.08



- The cabinets must be secured to the floor or to the wall
- Top shelf load capacity 50 kg
- All indicated loads are net and refer to evenly distributed weights



CABINETS SERIES PERFORM 1200

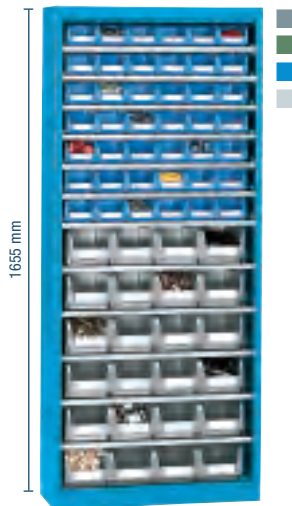

ORD. NO.	SHELVES
F AK 2066 54 04	12
Cabinet with 12 shelves depth 235 mm load capacity 50 kg 7 back plinths for containers, 42 size 1 blue containers, 24 size 2 grey containers Cabinet load capacity: 500 kg Dimensions mm 700x270x1655 h	

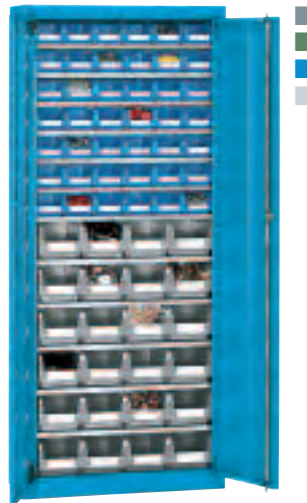

ORD. NO.	SHELVES
F AK 1066 54 04	12
Cabinet with 12 shelves depth 235 mm load capacity 50 kg 7 back plinths for containers, 42 size 1 blue containers, 24 size 2 grey containers Cabinet load capacity: 500 kg Dimensions mm 700x270x1655 h	



ORD. NO.	SHELVES
F AK 1066 63 04	
Cabinet with 1 Practibox frame 1500 mm in height, 2 ORD. NO. F PG 1071 01 01, 4 ORD. NO. F PG 1571 01 01, 3 ORD. NO. F PG 2071 01 01, 1 ORD. NO. F PG 2571 01 01, 1 ORD. NO. F PG 3071 01 01 Cabinet load capacity: 500 kg Dimensions mm 700x270x1655 h	

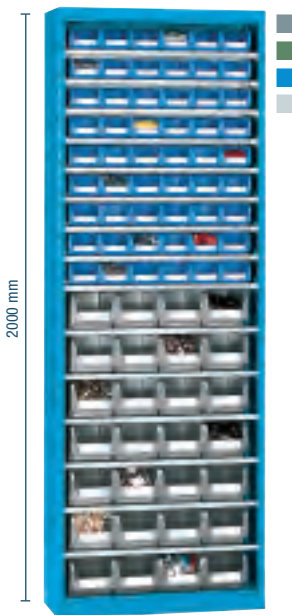

ORD. NO.	SHELVES
F AK 2080 52 04	15
Cabinet with 15 shelves depth 235 mm load capacity 50 kg 9 back plinths for containers, 54 size 1 blue containers, 28 size 2 grey containers Cabinet load capacity: 500 kg Dimensions mm 700x270x2000 h	

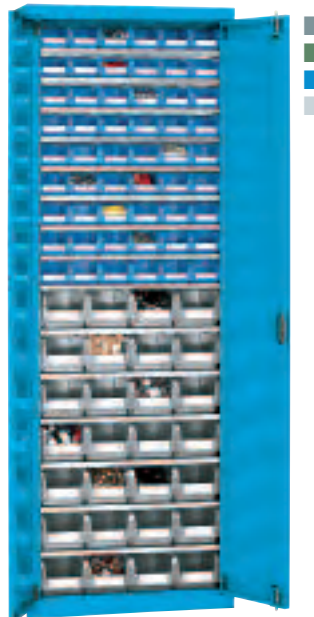

ORD. NO.	SHELVES
F AK 1080 52 04	15
Cabinet with 15 shelves depth 235 mm load capacity 50 kg 9 back plinths for containers, 54 size 1 blue containers, 28 size 2 grey containers Cabinet load capacity: 500 kg Dimensions mm 700x270x2000 h	



ORD. NO.	SHELVES
F AK 1080 58 04	
Cabinet with 1 Practibox frame 1750 mm in height, 1 ORD. NO. F PG 1071 01 01, 6 ORD. NO. F PG 1571 01 01, 2 ORD. NO. F PG 2071 01 01, 2 ORD. NO. F PG 2571 01 01, 1 ORD. NO. F PG 3071 01 01 Cabinet load capacity: 500 kg Dimensions mm 700x270x2000 h	

RAL 7000 F.01

RAL 6011 F.02

RAL 5012 F.04

RAL 7035 F.08

KEY ■

- The cabinets must be secured to the floor or to the wall
- Top shelf load capacity 50 kg
- All indicated loads are net and refer to evenly distributed weights



LENGTH = 700 mm DEPTH = 270 mm

CABINETS SERIES PERFORM 1200

EMPTY CABINET



ORD. NO. CABINET LOAD CAPACITY kg

F AK 2080 00 04 500

Dim. mm 700x270x2000 h

Internal dim. mm 650x235x1885 h

The F AK 2080 series cabinets are supplied as standard with 2 floor fixing brackets, 2 wall fixing brackets and 2 levelling devices.

EMPTY CABINET

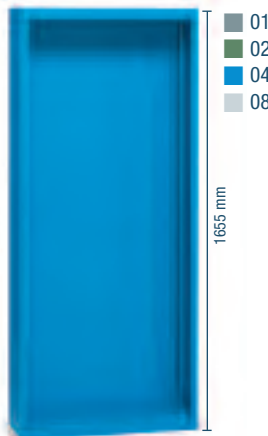

ORD. NO. CABINET LOAD CAPACITY kg

F AK 2066 00 04 500

Dim. mm 700x270x1655 h

Internal dim. mm 650x235x1535 h

The F AK 2066 series cabinets are supplied as standard with 2 floor fixing brackets, 2 wall fixing brackets and 2 levelling devices.

■ The cabinets must be secured to the floor or to the wall.

EMPTY CABINET

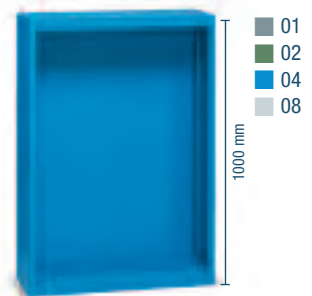

ORD. NO. CABINET LOAD CAPACITY kg

F AK 2040 00 04 450

Dim. mm 700x270x1000 h

Internal dim. mm 650x235x885 h

The F AK 2040 series cabinets are supplied as standard with 2 floor fixing brackets, 2 wall fixing brackets and 2 levelling devices.

EMPTY CABINET WITH DOORS

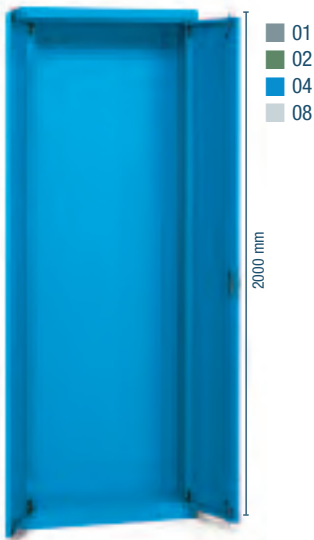

ORD. NO. CABINET LOAD CAPACITY kg

F AK 1080 00 04 500

Dim. mm 700x270x2000 h

Internal dim. mm 650x235x1885 h

The F AK 1080 series cabinets are supplied as standard with 2 floor fixing brackets, 2 wall fixing brackets and 2 levelling devices.

EMPTY CABINET WITH DOORS



ORD. NO. CABINET LOAD CAPACITY kg

F AK 1066 00 04 500

Dim. mm 700x270x1655 h

Internal dim. mm 650x235x1535 h

The F AK 1066 series cabinets are supplied as standard with 2 floor fixing brackets, 2 wall fixing brackets and 2 levelling devices.

■ The cabinets must be secured to the floor or to the wall.

EMPTY CABINET WITH DOORS

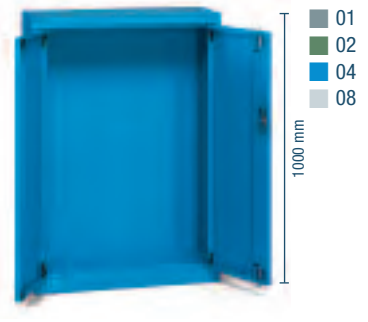

ORD. NO. CABINET LOAD CAPACITY kg

F AK 1040 00 04 450

Dim. mm 700x270x1000 h

Internal dim. mm 650x235x885 h

The serie F AK 1040 series cabinets are supplied as standard with 2 floor fixing brackets, 2 wall fixing brackets and 2 levelling devices.

ADJUSTABLE SHELF DEPTH 235 mm

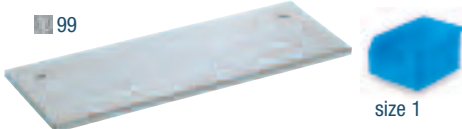

ORD. NO. LOAD CAPACITY kg

F AK 9020 01 99 50

Complete with 4 hooks

The depth of this shelf is suitable for the following containers: size 1 / size 2

Dimensions mm 675x235x17 h

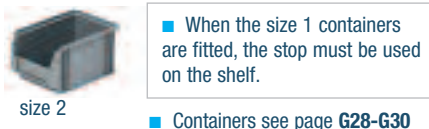

■ When the size 1 containers are fitted, the stop must be used on the shelf.

■ Containers see page G28-G30



STOP FOR CONTAINERS
SIZE 1



ORD. NO. **F AK 9040 00 99**

fitting of the stop



PRACTIBOX

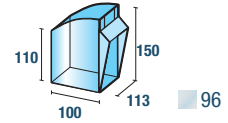
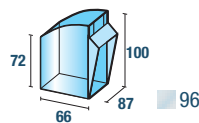
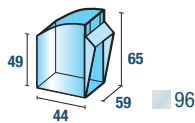

■ 01

ORD. NO.**F PG 1071 01 01**

Drawer unit with 9 compartments
 Dimensions mm 600x51x77 h



■ 01

ORD. NO.**F PG 1571 01 01**

Drawer unit with 6 compartments
 Dimensions mm 600x98x112 h

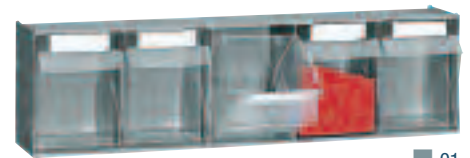

■ 01

ORD. NO.**F PG 2071 01 01**

Drawer unit with 5 compartments
 Dimensions mm 600x138x164 h

RAL 7000 F.01

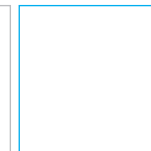
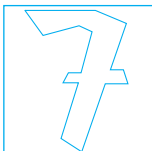
**INFO ■**

www.famispa.com





■ RAL 5012

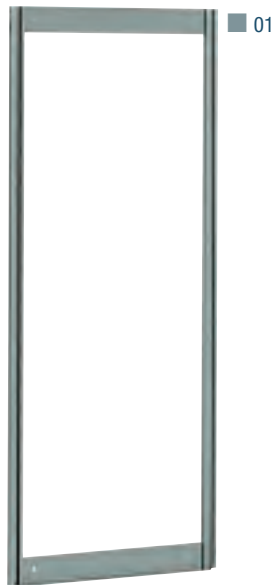

ORD. NO.

F PG 0541 00 01

Practibox frame
for cabinets series F AK 1066 / 2066
Dimensions mm 600x41x1500 h

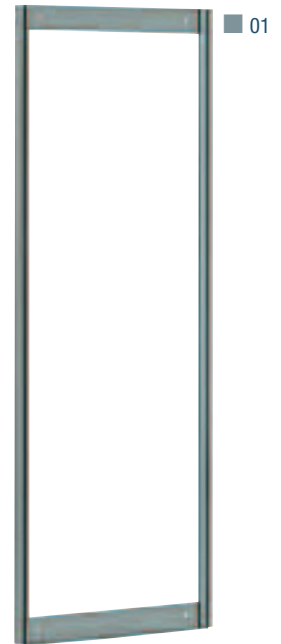

ORD. NO.

F PG 0551 00 01

Practibox frame
for cabinets series F AK 1080 / 2080
Dimensions mm 600x41x1750 h

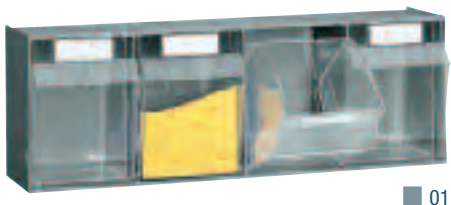
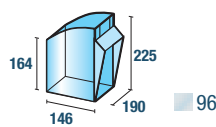
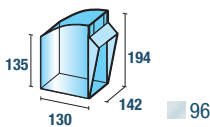

ORD. NO.

F PG 2571 01 01

Drawer unit with 4 compartments
Dimensions mm 600x174x206 h



ORD. NO.

F PG 3071 01 01

Drawer unit with 3 compartments
Dimensions mm 600x206x240 h



■ PRACTIBOX can be stacked and assembled into the frame.

■ INFO

RAL 7000 F.01



www.famispa.com

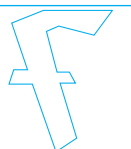

CABINETS SERIES PERFORM



RAL 5012 +
RAL 7000 F.51

SUPPLEMENTARY PARTS ■

■ **Spare key.** Always indicate the number on the cylinder lock of the key to be replaced.

ORD. NO. R CSC 0002 00

■ **Master key.** This type of key opens all the 45 and 46 series locks.

ORD. NO. R CSC 0001 00

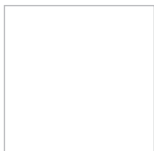
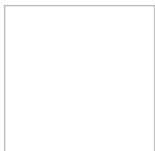
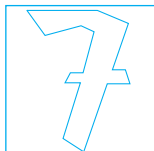

WIDTH = 585 mm DEPTH = 402 mm

SERIES PERFORM GS501



■ For benches see page **A286**



■ **Standard colours**

blue RAL 5012 + grey RAL 7000
F 51

■ Locker with 3 compartments

■ 3 point locking

■ 51



ORD. NO.

F AN 5010 01 51

Cabinet with cylinder lock

Dimensions mm 585x402x1750 h

■ **SUPPLEMENTARY PARTS**



- Replacement lock with 2 keys: **ORD. NO. R CSR 0025 00**
- Pair of replacement rods with accessories: **ORD. NO. R XAN 0002 99**

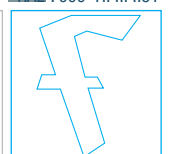
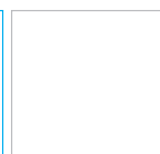

RAL 5012 + RAL 7000 F.51

SERIES **PERFOM** GS110



■ 01 ■ 02 ■ 04 ■ 08

■ Locker with fixed upper shelf, 3 height-adjustable lateral shelves and fixed separation panel.



■ 01
■ 02
■ 04
■ 08

ORD. NO.

F AN 1101 01 01

Cabinet with cylinder lock

Dimensions mm 1023x555x2000 h



RAL 7000 F.01 RAL 6011 F.02 RAL 5012 F.04 RAL 7035 F.08

SUPPLEMENTARY PARTS ■

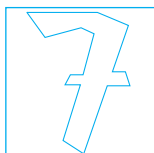

- Replacement lock with 2 keys:
- Pair of replacement rods with accessories:

ORD. NO. R CSR 0011 00
ORD. NO. R XAC 0010 99



WIDTH = 585 mm DEPTH = 500 mm

SERIES PERFORM GS120



■ 51



■ For benches see page A286



■ Standard colours

blue RAL 5012 + grey RAL 7000
F 51

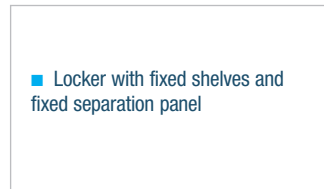

■ Locker with fixed shelves and fixed separation panel

ORD. NO.	ACCESSORIES	DIMENSIONS mm
F AN 1201 01 51	without feet	585x500x1750 h
F AN 1201 07 51	with feet	585x500x1950 h

cylinder lock

ORD. NO.	ACCESSORIES	DIMENSIONS mm
F AN 1201 11 51	without feet	585x500x1750 h
F AN 1201 17 51	with feet	585x500x1950 h

locking mechanism



■ 51

180/200 mm

■ SUPPLEMENTARY PARTS



- Replacement lock with 2 keys: ORD. NO. R CSR 0018 00
- Replacement locking mechanism: ORD. NO. R CSR 0024 00



■ The plastic legs are supplied unassembled

RAL 5012 + RAL 7000 F. 51

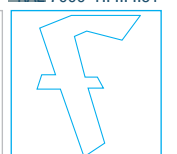

SERIES **PERFOM** GS130

■ ■ 51

With compartment for helmet



■ Locker with height-adjustable shelf for helmet



■ **Standard colours**
blue RAL 5012 + grey RAL 7000
F 51



■ For benches see page **A286**

■ ■ 51



ORD. NO.	COMPARTMENTS NO.	ACCESSORIES	DIMENSIONS mm
F AN 1302 01 51	2	without feet	610x500x1750 h
F AN 1302 07 51	2	with feet	610x500x1950 h
F AN 1303 01 51	3	without feet	900x500x1750 h
F AN 1303 07 51	3	with feet	900x500x1950 h
F AN 1304 01 51	4	without feet	1195x500x1750 h
F AN 1304 07 51	4	with feet	1195x500x1950 h

cylinder lock

ORD. NO.	COMPARTMENTS NO.	ACCESSORIES	DIMENSIONS mm
F AN 1302 11 51	2	without feet	610x500x1750 h
F AN 1302 17 51	2	with feet	610x500x1950 h
F AN 1303 11 51	3	without feet	900x500x1750 h
F AN 1303 17 51	3	with feet	900x500x1950 h
F AN 1304 11 51	4	without feet	1195x500x1750 h
F AN 1304 17 51	4	with feet	1195x500x1950 h

locking mechanism

RAL 5012 + RAL 7000 F... ..51

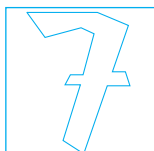

■ The plastic legs are supplied unassembled



SUPPLEMENTARY PARTS ■

- Replacement lock with 2 keys: **ORD. NO. R CSR 0018 00**
- Replacement locking mechanism: **ORD. NO. R CSR 0024 00**



UNIT WIDTH = 300 mm DEPTH = 500 mm

SERIE PERFORM GS230



■ 51

With slanting top and compartment for helmet



■ For benches see page A286



■ Standard colours

blue RAL 5012 + grey RAL 7000
F 51

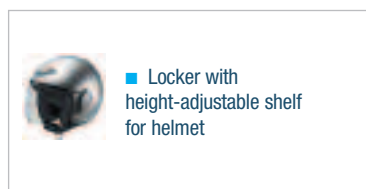

■ Locker with height-adjustable shelf for helmet

ORD. NO.	COMPARTMENTS NO.	ACCESSORIES	DIMENSIONS mm
F AN 2302 01 51	2	without feet	610x500x1940 h
F AN 2302 07 51	2	with feet	610x500x2140 h
F AN 2303 01 51	3	without feet	900x500x1940 h
F AN 2303 07 51	3	with feet	900x500x2140 h
F AN 2304 01 51	4	without feet	1195x500x1940 h
F AN 2304 07 51	4	with feet	1195x500x2140 h

cylinder lock

ORD. NO.	COMPARTMENTS NO.	ACCESSORIES	DIMENSIONS mm
F AN 2302 11 51	2	without feet	610x500x1940 h
F AN 2302 17 51	2	with feet	610x500x2140 h
F AN 2303 11 51	3	without feet	900x500x1940 h
F AN 2303 17 51	3	with feet	900x500x2140 h
F AN 2304 11 51	4	without feet	1195x500x1940 h
F AN 2304 17 51	4	with feet	1195x500x2140 h

locking mechanism

■ 51



■ SUPPLEMENTARY PARTS



- Replacement lock with 2 keys: ORD. NO. R CSR 0018 00
- Replacement locking mechanism: ORD. NO. R CSR 0024 00



■ The plastic legs are supplied unassembled

RAL 5012 + RAL 7000 F. ... 51

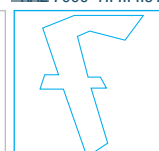

SERIES PERFORM GS140

■ ■ 51

With compartment for helmet



■ Locker with height-adjustable shelf for helmet



■ **Standard colours**
blue RAL 5012 + grey RAL 7000
F 51



■ For benches see page A286

■ ■ 51



ORD. NO.	COMPARTMENTS NO.	ACCESSORIES	DIMENSIONS mm
F AN 1402 01 51	2	without feet	805x500x1750 h
F AN 1402 07 51	2	with feet	805x500x1950 h
F AN 1403 01 51	3	without feet	1195x500x1750 h
F AN 1403 07 51	3	with feet	1195x500x1950 h

cylinder lock

ORD. NO.	COMPARTMENTS NO.	ACCESSORIES	DIMENSIONS mm
F AN 1402 11 51	2	without feet	805x500x1750 h
F AN 1402 17 51	2	with feet	805x500x1950 h
F AN 1403 11 51	3	without feet	1195x500x1750 h
F AN 1403 17 51	3	with feet	1195x500x1950 h

locking mechanism

RAL 5012 + RAL 7000 F... ..51

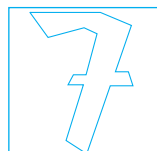

■ The plastic legs are supplied unassembled



SUPPLEMENTARY PARTS ■

- Replacement lock with 2 keys: ART. R CSR 0018 00
- Replacement locking mechanism: ART. R CSR 0024 00



UNIT WIDTH = 400 mm DEPTH = 500 mm

SERIES PERFORM GS240



■ 51

With slanting top and compartment for helmet



■ For benches see page A286



■ Standard colours
blue RAL 5012 + grey RAL 7000
F 51

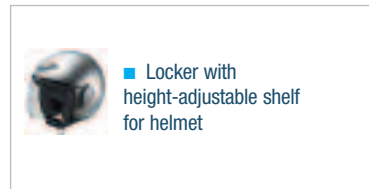

■ Locker with height-adjustable shelf for helmet

■ 51

ORD. NO.	COMPARTMENTS NO.	ACCESSORIES	DIMENSIONS mm
F AN 2402 01 51	2	without feet	805x500x1940 h
F AN 2402 07 51	2	with feet	805x500x2140 h
F AN 2403 01 51	3	without feet	1195x500x1940 h
F AN 2403 07 51	3	with feet	1195x500x2140 h

cylinder lock

ORD. NO.	COMPARTMENTS NO.	ACCESSORIES	DIMENSIONS mm
F AN 2402 11 51	2	without feet	805x500x1940 h
F AN 2402 17 51	2	with feet	805x500x2140 h
F AN 2403 11 51	3	without feet	1195x500x1940 h
F AN 2403 17 51	3	with feet	1195x500x2140 h

locking mechanism



■ SUPPLEMENTARY PARTS



- Replacement lock with 2 keys: ART. R CSR 0018 00
- Replacement locking mechanism: ART. R CSR 0024 00



■ The plastic legs are supplied unassembled

■ RAL 5012 + RAL 7000 F. ... 51

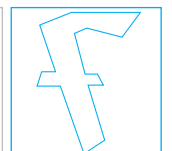

SERIES PERFORM GS150

■ ■ 51

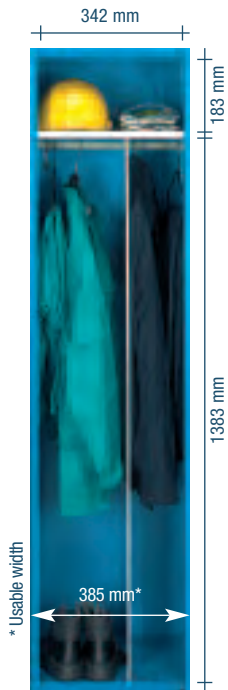

■ Locker with fixed shelf and adjustable separation panel



■ Standard colours

blue RAL 5012 + grey RAL 7000
F 51



■ For benches see page A286

■ ■ 51



ORD. NO.	COMPARTMENTS NO.	ACCESSORIES	DIMENSIONS mm
F AN 1502 01 51	2	without feet	805x500x1750 h
F AN 1502 07 51	2	with feet	805x500x1950 h
F AN 1503 01 51	3	without feet	1195x500x1750 h
F AN 1503 07 51	3	with feet	1195x500x1950 h

cylinder lock

ORD. NO.	COMPARTMENTS NO.	ACCESSORIES	DIMENSIONS mm
F AN 1502 11 51	2	without feet	805x500x1750 h
F AN 1502 17 51	2	with feet	805x500x1950 h
F AN 1503 11 51	3	without feet	1195x500x1750 h
F AN 1503 17 51	3	with feet	1195x500x1950 h

locking mechanism

RAL 5012 + RAL 7000 F. 51

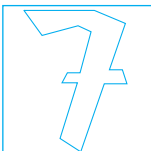

■ The plastic legs are supplied unassembled



SUPPLEMENTARY PARTS ■

- Replacement lock with 2 keys: ART. R CSR 0018 00
- Replacement locking mechanism: ART. R CSR 0024 00



UNIT WIDTH = 400 mm DEPTH = 500 mm

SERIES PERFORM GS150



■ 51

With compartment for helmet



■ For benches see page A286



■ Standard colours
blue RAL 5012 + grey RAL 7000
F 51

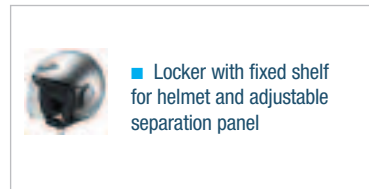

■ Locker with fixed shelf for helmet and adjustable separation panel

ORD. NO.	COMPARTMENTS NO.	ACCESSORIES	DIMENSIONS mm
F AN 1502 31 51	2	without feet	805x500x1750 h
F AN 1502 37 51	2	with feet	805x500x1950 h
F AN 1503 31 51	3	without feet	1195x500x1750 h
F AN 1503 37 51	3	with feet	1195x500x1950 h

cylinder lock

ORD. NO.	COMPARTMENTS NO.	ACCESSORIES	DIMENSIONS mm
F AN 1502 41 51	2	without feet	805x500x1750 h
F AN 1502 47 51	2	with feet	805x500x1950 h
F AN 1503 41 51	3	without feet	1195x500x1750 h
F AN 1503 47 51	3	with feet	1195x500x1950 h

locking mechanism



■ 51

■ SUPPLEMENTARY PARTS



- Replacement lock with 2 keys: ART. R CSR 0018 00
- Replacement locking mechanism: ART. R CSR 0024 00



■ The plastic legs are supplied unassembled

RAL 5012 + RAL 7000 F.51

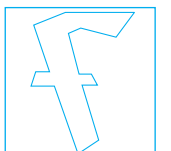

SERIES **PERFORM** GS250

■ ■ 51

With slanting top



■ Locker with fixed shelf and adjustable separation panel



■ **Standard colours**
blue RAL 5012 + grey RAL 7000
F 51



■ For benches see page **A286**

■ ■ 51



ORD. NO.	COMPARTMENTS NO.	ACCESSORIES	DIMENSIONS mm
F AN 2502 01 51	2	without feet	805x500x1940 h
F AN 2502 07 51	2	with feet	805x500x2140 h
F AN 2503 01 51	3	without feet	1195x500x1940 h
F AN 2503 07 51	3	with feet	1195x500x2140 h

cylinder lock

ORD. NO.	COMPARTMENTS NO.	ACCESSORIES	DIMENSIONS mm
F AN 2502 11 51	2	without feet	805x500x1940 h
F AN 2502 17 51	2	with feet	805x500x2140 h
F AN 2503 11 51	3	without feet	1195x500x1940 h
F AN 2503 17 51	3	with feet	1195x500x2140 h

locking mechanism

RAL 5012 + RAL 7000 F... ..51

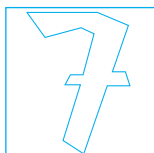

■ The plastic legs are supplied unassembled



SUPPLEMENTARY PARTS ■

- Replacement lock with 2 keys: ART. R CSR 0018 00
- Replacement locking mechanism: ART. R CSR 0024 00



UNIT WIDTH = 400 mm DEPTH = 500 mm

SERIES PERFORM GS250



■ 51

With slanting top and compartment for helmet



■ For benches see page A286



■ Standard colours

blue RAL 5012 + grey RAL 7000
F 51

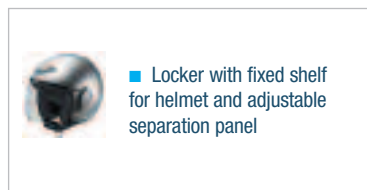

■ Locker with fixed shelf for helmet and adjustable separation panel

ORD. NO.	COMPARTMENTS NO.	ACCESSORIES	DIMENSIONS mm
F AN 2502 31 51	2	without feet	805x500x1940 h
F AN 2502 37 51	2	with feet	805x500x2140 h
F AN 2503 31 51	3	without feet	1195x500x1940 h
F AN 2503 37 51	3	with feet	1195x500x2140 h

cylinder lock

ORD. NO.	COMPARTMENTS NO.	ACCESSORIES	DIMENSIONS mm
F AN 2502 41 51	2	without feet	805x500x1940 h
F AN 2502 47 51	2	with feet	805x500x2140 h
F AN 2503 41 51	3	without feet	1195x500x1940 h
F AN 2503 47 51	3	with feet	1195x500x2140 h

locking mechanism

■ 51



■ SUPPLEMENTARY PARTS



- Replacement lock with 2 keys: ART. R CSR 0018 00
- Replacement locking mechanism: ART. R CSR 0024 00



■ The plastic legs are supplied unassembled

RAL 5012 + RAL 7000 F. ... 51

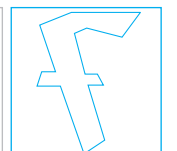

SERIES PERFORM GS160

UNIT WIDTH = 400 mm DEPTH = 500 mm

■ 51

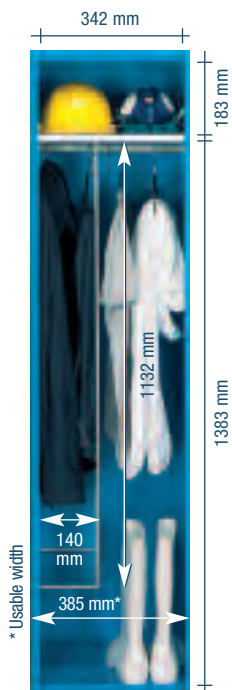

■ Locker with fixed shelf and fixed separation panel



■ **Standard colours**
blue RAL 5012 + grey RAL 7000
F 51



■ For benches see page **A286**

■ 51



ORD. NO.	COMPARTMENTS NO.	ACCESSORIES	DIMENSIONS mm
F AN 1602 01 51	2	without feet	805x500x1750 h
F AN 1602 07 51	2	with feet	805x500x1950 h
F AN 1603 01 51	3	without feet	1195x500x1750 h
F AN 1603 07 51	3	with feet	1195x500x1950 h

cylinder lock

ORD. NO.	COMPARTMENTS NO.	ACCESSORIES	DIMENSIONS mm
F AN 1602 11 51	2	without feet	805x500x1750 h
F AN 1602 17 51	2	with feet	805x500x1950 h
F AN 1603 11 51	3	without feet	1195x500x1750 h
F AN 1603 17 51	3	with feet	1195x500x1950 h

locking mechanism

RAL 5012 + RAL 7000 F. 51

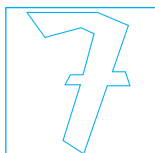

■ The plastic legs are supplied unassembled



SUPPLEMENTARY PARTS ■

- Replacement lock with 2 keys: ART. R CSR 0018 00
- Replacement locking mechanism: ART. R CSR 0024 00



UNIT WIDTH = 400 mm DEPTH = 500 mm

SERIES **PERFORM** GS260



■ 51

With slanting top

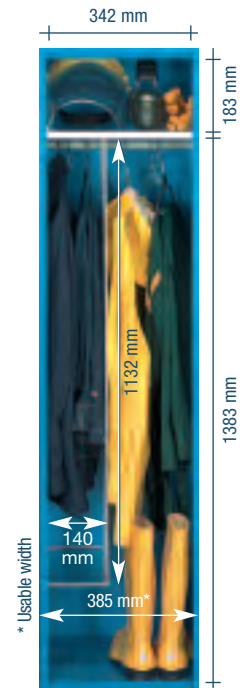

■ Locker with fixed shelf and fixed separation panel

■ **Standard colours**
blue RAL 5012 + grey RAL 7000
F 51

■ For benches see page **A286**

ORD. NO.	COMPARTMENTS NO.	ACCESSORIES	DIMENSIONS mm
F AN 2602 01 51	2	without feet	805x500x1940 h
F AN 2602 07 51	2	with feet	805x500x2140 h
F AN 2603 01 51	3	without feet	1195x500x1940 h
F AN 2603 07 51	3	with feet	1195x500x2140 h

cylinder lock

ORD. NO.	COMPARTMENTS NO.	ACCESSORIES	DIMENSIONS mm
F AN 2602 11 51	2	without feet	805x500x1940 h
F AN 2602 17 51	2	with feet	805x500x2140 h
F AN 2603 11 51	3	without feet	1195x500x1940 h
F AN 2603 17 51	3	with feet	1195x500x2140 h

locking mechanism

■ 51



■ **SUPPLEMENTARY PARTS**



- Replacement lock with 2 keys: ART. R CSR 0018 00
- Replacement locking mechanism: ART. R CSR 0024 00



■ The plastic legs are supplied unassembled

■ RAL 5012 + RAL 7000 F. ... 51

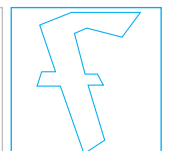

SERIES PERFORM GS170

■ 51



■ Locker with fixed shelf and fixed separation panel

■ **Standard colours**
blue RAL 5012 + grey RAL 7000
F 51

■ For benches see page A286

■ 51



ORD. NO.	COMPARTMENTS NO.	ACCESSORIES	DIMENSIONS mm
F AN 1701 01 51	1	without feet	585x500x1750 h
F AN 1701 07 51	1	with feet	585x500x1950 h
F AN 1702 01 51	2	without feet	1145x500x1750 h
F AN 1702 07 51	2	with feet	1145x500x1950 h

cylinder lock

RAL 5012 + RAL 7000 F. 51

SUPPLEMENTARY PARTS ■

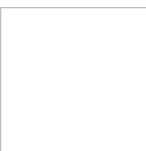
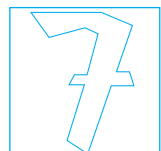

■ The plastic legs are supplied unassembled



■ Replacement lock with 2 keys: ART. R CSR 0029 00
■ Pair of replacement rods with accessories: ART. R XAN 0002 99



UNIT WIDTH = 585 mm DEPTH = 500 mm

SERIES **PERFORM** GS180



■ 51



■ Locker with fixed shelf and fixed separation panel.

■ **Standard colours**
blue RAL 5012 + grey RAL 7000
F 51

■ For benches see page **A286**

ORD. NO.	COMPARTMENTS NO.	ACCESSORIES	DIMENSIONS mm
F AN 1801 01 51	1	without feet	585x500x1750 h
F AN 1801 07 51	1	with feet	585x500x1950 h
F AN 1802 01 51	2	without feet	1145x500x1750 h
F AN 1802 07 51	2	with feet	1145x500x1950 h

cylinder lock

ORD. NO.	COMPARTMENTS NO.	ACCESSORIES	DIMENSIONS mm
F AN 1801 11 51	1	without feet	585x500x1750 h
F AN 1801 17 51	1	with feet	585x500x1950 h
F AN 1802 11 51	2	without feet	1145x500x1750 h
F AN 1802 17 51	2	with feet	1145x500x1950 h

locking mechanism



■ 51

■ **SUPPLEMENTARY PARTS**



- Replacement lock with 2 keys: ART. R CSR 0018 00
- Replacement locking mechanism: ART. R CSR 0024 00



■ The plastic legs are supplied unassembled.

■ RAL 5012 + RAL 7000 F.51

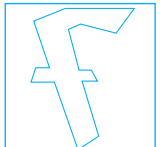

SERIES PERFORM GS190

■ 51



■ Locker with 2 vertical compartments placed one on top of the other

■ **Standard colours**

blue RAL 5012 + grey RAL 7000
F 51

■ For benches see page A286

■ 51



ORD. NO.	COMPARTMENTS NO.	ACCESSORIES	DIMENSIONS mm
F AN 1904 01 51	2x2	without feet	610x500x1750 h
F AN 1904 07 51	2x2	with feet	610x500x1950 h
F AN 1906 01 51	2x3	without feet	900x500x1750 h
F AN 1906 07 51	2x3	with feet	900x500x1950 h
F AN 1908 01 51	2x4	without feet	1195x500x1750 h
F AN 1908 07 51	2x4	with feet	1195x500x1950 h

cylinder lock

ORD. NO.	COMPARTMENTS NO.	ACCESSORIES	DIMENSIONS mm
F AN 1904 11 51	2x2	without feet	610x500x1750 h
F AN 1904 17 51	2x2	with feet	610x500x1950 h
F AN 1906 11 51	2x3	without feet	900x500x1750 h
F AN 1906 17 51	2x3	with feet	900x500x1950 h
F AN 1908 11 51	2x4	without feet	1195x500x1750 h
F AN 1908 17 51	2x4	with feet	1195x500x1950 h

locking mechanism

RAL 5012 + RAL 7000 F... ..51

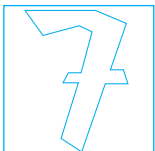

■ The plastic legs are supplied unassembled



SUPPLEMENTARY PARTS ■

■ Replacement lock with 2 keys: ART. R CSR 0017 00
 ■ Replacement locking mechanism: ART. R CSR 0022 00

UNIT WIDTH = 300/400 mm DEPTH = 500 mm

SERIES PERFORM FS700/730

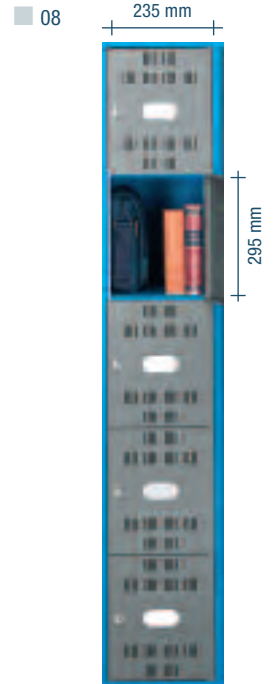

08



ORD. NO.	COMPARTMENTS NO.	ACCESSORIES	DIMENSIONS mm
F AM 7010 01 08	14	without feet	2025x500x1750* h
F AM 7012 01 08	14	with feet	2025x500x1950* h
F AM 7310 01 08	14	without feet	2325x500x1750** h
F AM 7312 01 08	14	with feet	2325x500x1950** h

cylinder lock

*with 1000 mm long shelves **with 1300 mm long shelves

ORD. NO.	COMPARTMENTS NO.	ACCESSORIES	DIMENSIONS mm
F AM 7020 01 08	14	without feet	2025x500x1750* h
F AM 7022 01 08	14	with feet	2025x500x1950* h
F AM 7320 01 08	14	without feet	2325x500x1750** h
F AM 7322 01 08	14	with feet	2325x500x1950** h

locking mechanism

*with 1000 mm long shelves **with 1300 mm long shelves

■ SUPPLEMENTARY PARTS



- Replacement lock with 2 keys: ART. R CSR 0017 00
- Replacement locking mechanism: ART. R CSR 0022 00



■ The plastic legs are supplied unassembled

RAL 7035 F. 08

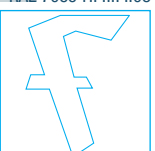

SERIES PERFORM FS1000/1100/1200



■ ■ 51

235 mm

SERIES FS1000



295 mm

■ ■ 51

235 mm

SERIES FS1100



380 mm

■ ■ 51

335 mm

SERIES FS1200



380 mm

■ ■ 51

■ **Standard colours**

blue RAL 5012 + grey RAL 7000
F... .. 51

■ For benches see page A286

RAL 5012 + RAL 7000 F... ..51

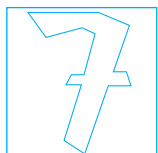

■ The plastic legs are supplied unassembled



SUPPLEMENTARY PARTS ■

- Replacement lock with 2 keys: ART. R CSR 0017 00
- Replacement locking mechanism: ART. R CSR 0022 00



UNIT WIDTH = 300 / 400 mm DEPTH = 500 mm

SERIES PERFORM FS1000/1100/1200

ORD. NO.	COMPARTMENTS NO.	ACCESSORIES	DIMENSIONS mm
F AM 1025 01 51	2x5	without feet	610x500x1750 h
F AM 1025 07 51	2x5	with feet	610x500x1950 h
F AM 1035 01 51	3x5	without feet	900x500x1750 h
F AM 1035 07 51	3x5	with feet	900x500x1950 h
F AM 1045 01 51	4x5	without feet	1195x500x1750 h
F AM 1045 07 51	4x5	with feet	1195x500x1950 h

cylinder lock

ORD. NO.	COMPARTMENTS NO.	ACCESSORIES	DIMENSIONS mm
F AM 1025 11 51	2x5	without feet	610x500x1750 h
F AM 1025 17 51	2x5	with feet	610x500x1950 h
F AM 1035 11 51	3x5	without feet	900x500x1750 h
F AM 1035 17 51	3x5	with feet	900x500x1950 h
F AM 1045 11 51	4x5	without feet	1195x500x1750 h
F AM 1045 17 51	4x5	with feet	1195x500x1950 h

locking mechanism



SERIES FS1000



SERIES FS1100

ORD. NO.	COMPARTMENTS NO.	ACCESSORIES	DIMENSIONS mm
F AM 1124 01 51	2x4	without feet	610x500x1750 h
F AM 1124 07 51	2x4	with feet	610x500x1950 h
F AM 1134 01 51	3x4	without feet	900x500x1750 h
F AM 1134 07 51	3x4	with feet	900x500x1950 h
F AM 1144 01 51	4x4	without feet	1195x500x1750 h
F AM 1144 07 51	4x4	with feet	1195x500x1950 h

cylinder lock

ORD. NO.	COMPARTMENTS NO.	ACCESSORIES	DIMENSIONS mm
F AM 1124 11 51	2x4	without feet	610x500x1750 h
F AM 1124 17 51	2x4	with feet	610x500x1950 h
F AM 1134 11 51	3x4	without feet	900x500x1750 h
F AM 1134 17 51	3x4	with feet	900x500x1950 h
F AM 1144 11 51	4x4	without feet	1195x500x1750 h
F AM 1144 17 51	4x4	with feet	1195x500x1950 h

locking mechanism

ORD. NO.	COMPARTMENTS NO.	ACCESSORIES	DIMENSIONS mm
F AM 1214 01 51	1x4	without feet	415x500x1750 h
F AM 1214 07 51	1x4	with feet	415x500x1950 h
F AM 1224 01 51	2x4	without feet	805x500x1750 h
F AM 1224 07 51	2x4	with feet	805x500x1950 h
F AM 1234 01 51	3x4	without feet	1195x500x1750 h
F AM 1234 07 51	3x4	with feet	1195x500x1950 h

cylinder lock

ORD. NO.	COMPARTMENTS NO.	ACCESSORIES	DIMENSIONS mm
F AM 1214 11 51	1x4	without feet	415x500x1750 h
F AM 1214 17 51	1x4	with feet	415x500x1950 h
F AM 1224 11 51	2x4	without feet	805x500x1750 h
F AM 1224 17 51	2x4	with feet	805x500x1950 h
F AM 1234 11 51	3x4	without feet	1195x500x1750 h
F AM 1234 17 51	3x4	with feet	1195x500x1950 h

locking mechanism



SERIES FS1200

■ SUPPLEMENTARY PARTS



- Replacement lock with 2 keys: ART. R CSR 0017 00
- Replacement locking mechanism: ART. R CSR 0022 00



■ The plastic legs are supplied unassembled

RAL 5012 + RAL 7000 F... ..51

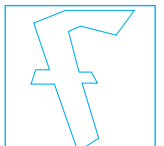

SERIES PERFORM GS/FS

SINGLE-SIDED AND DOUBLE-SIDED BENCHES

Solid bench made from welded tubular steel with adjustable legs. The 300 mm deep seating area is covered with plastic profiles.

■ 01



SINGLE-SIDED BENCHES

ORD. NO.	LOCKER WIDTH mm
F AM 9010 00 01	585
F AM 9020 00 01	610
F AM 9030 00 01	805
F AM 9040 00 01	900
F AM 9050 00 01	1145
F AM 9060 00 01	1195

Depth

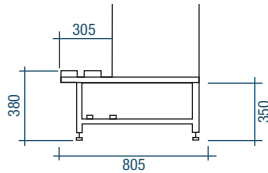

■ 01



DOUBLE-SIDED BENCHES

ORD. NO.	LOCKER WIDTH mm
F AM 9110 00 01	585
F AM 9120 00 01	610
F AM 9130 00 01	805
F AM 9140 00 01	900
F AM 9150 00 01	1145
F AM 9160 00 01	1195

Depth

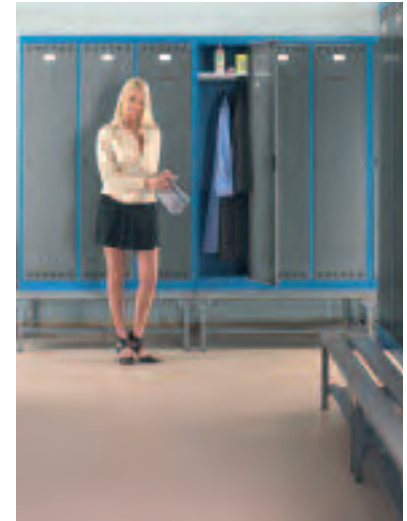
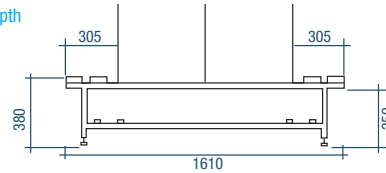

Example of using single-sided benches

SINGLE-SIDED AND DOUBLE-SIDED BENCHES WITH SHOE STORAGE FACILITY

Solid bench made from welded tubular steel with adjustable legs. The 300 mm deep seating area is covered with plastic profiles. A handy shoe storage facility is located under the bench.

■ 01



SINGLE-SIDED BENCHES

ORD. NO.	LOCKER WIDTH mm
F AM 9010 01 01	585
F AM 9020 01 01	610
F AM 9030 01 01	805
F AM 9040 01 01	900
F AM 9050 01 01	1145
F AM 9060 01 01	1195

Depth

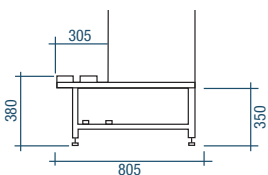

■ 01



DOUBLE-SIDED BENCHES

ORD. NO.	LOCKER WIDTH mm
F AM 9110 01 01	585
F AM 9120 01 01	610
F AM 9130 01 01	805
F AM 9140 01 01	900
F AM 9150 01 01	1145
F AM 9160 01 01	1195

Depth

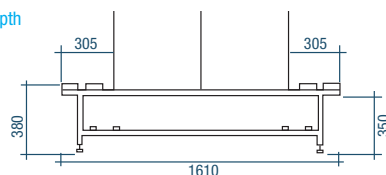

Example of using double-sided benches

RAL 7000 F.01

INFO ■



DEPTH = 360 mm

SERIES **PERFORM** GS/FS

2000 - 1500 - 1000 mm BENCHES

Solid bench made from welded tubular steel with adjustable legs. The 360 mm deep seating area is covered with plastic profiles.

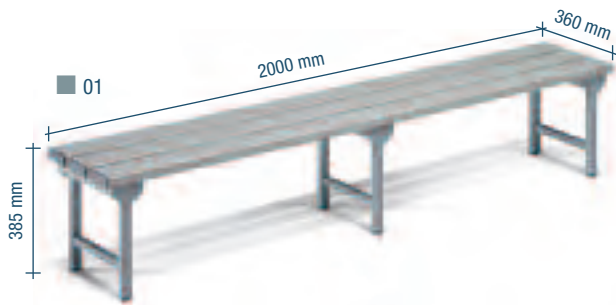

ORD. NO.	DIMENSIONS mm
F AN 9560 00 01	2000x360x385

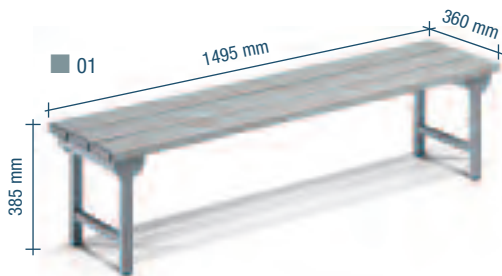

ORD. NO.	DIMENSIONS mm
F AN 9550 00 01	1495x360x385

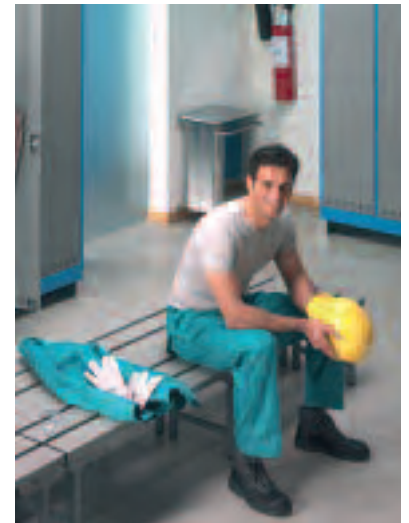

Example of using benches

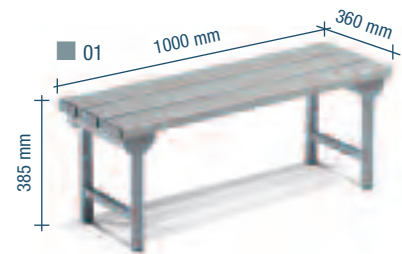

ORD. NO.	DIMENSIONS mm
F AN 9540 00 01	1000x360x385

SHOE HOLDER

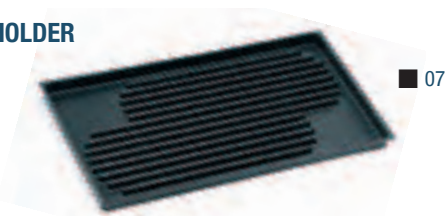

ORD. NO.	DIMENSIONS mm
F AM 9600 00 07	230x460x23

Shoe holder made from 3 mm thickness heat-shaped plastic. Handy for storing shoes inside lockers.



Example of using the shoe holder

UMBRELLA HOLDER



ORD. NO.	DIMENSIONS mm
F AN 9320 00 04	100x1008

Waterproof umbrella holder with plug for draining water. The waterproof fabric and watertight plastic prevent water from leaking and keeps the locker and its contents dry.



Example of using the umbrella holder

■ **INFO**

RAL 5012 F.04 RAL 7000 F.01



www.famispaspa.com

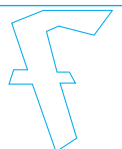

SERIES PERFORM GS/FS

PAIR OF BASE PLINTHS

Pair of galvanised steel base plinths. Bolted to the locker.

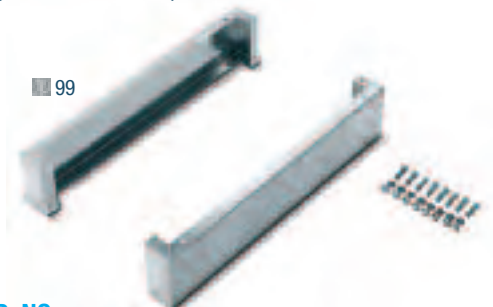

■ 99

ORD. NO.

DIMENSIONS mm

F AM 9000 00 99**50x498x100**

This pair of base plinths can be used with the following series of lockers:

F AN 1200 / F AN 1300 / F AN 1400 / F AN 1500 / F AN 1600
F AN 1700 / F AN 1800 / F AN 1900 / F AN 2300 / F AN 2400
F AN 2500 / F AN 2600 / F AM 1000 / F AM 1100 / F AM 1200
F AM 7000 / F AM 7300



Example of using the pair of base plinths

PAIR OF PLASTIC LEGS

Pair of plastic legs in polypropylene, can be height-adjusted from 180 to 200 mm.

■ 01

■ 07



ORD. NO.

COLOUR

DIMENSIONS mm

F RR 2310 00 01

grey RAL 7000

135x500x180/200**F RR 2310 00 07**

black RAL 9011

135x500x180/200

This pair of plastic legs can be used with the following series of lockers:

F AN 1200 / F AN 1300 / F AN 1400 / F AN 1500 / F AN 1600 / F AN 1700
F AN 1800 / F AN 1900 / F AN 2300 / F AN 2400 / F AN 2500 / F AN 2600
F AM 1000 / F AM 1100 / F AM 1200 / F AM 7000 / F AM 7300



Example of using a pair of plastic legs

REPLACEMENT LOCKING MECHANISM

ORD. NO.

R CSR 0022 00

Suitable for lockers series:

F AN 1900 / F AM 1000 / F AM 1100 / F AM 1200 / F AM 7000 /
F AM 7300



REPLACEMENT LOCKING MECHANISM

ORD. NO.

R CSR 0024 00

Suitable for lockers series:

F AN 1000 / F AN 1200 / F AN 1300 / F AN 2300 / F AN 1400 / F AN 2400 /
F AN 1500 / F AN 2500 / F AN 1600 / F AN 2600 / F AN 1800



REPLACEMENT LOCK WITH 2 KEYS

ORD. NO.

R CSR 0017 00

KEY WITH NUMBER FROM

25000 - 26999

Suitable for lockers series:

F AN 1900 / F AM 1000 / F AM 1100 / F AM 1200 / F AM 7000 /
F AM 7300



REPLACEMENT LOCK WITH 2 KEYS

ORD. NO.

R CSR 0018 00

KEY WITH NUMBER FROM

25000 - 26999

Suitable for lockers series:

F AN 1200 / F AN 1300 / F AN 2300 / F AN 1400 / F AN 2400 / F AN 1500 /
F AN 2500 / F AN 1600 / F AN 2600 / F AN 1800



REPLACEMENT LOCK WITH 2 KEYS

ORD. NO.

R CSR 0011 00

KEY WITH NUMBER FROM

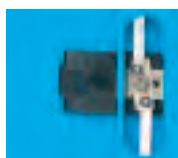
45000 - 46999

REPLACEMENT LOCK WITH 2 KEYS

ORD. NO.

R CSR 0025 00

KEY WITH NUMBER FROM

45000 - 46999

PAIR OF REPLACEMENT RODS WITH ACCESSORIES

ORD. NO.

R XAC 0010 99

SUITABLE FOR LOCKERS SERIES

F AN 1100

PAIR OF REPLACEMENT RODS WITH ACCESSORIES

ORD. NO.

R XAN 0002 99

SUITABLE FOR LOCKERS SERIES

F AN 5000

PERFOM

SERIES PERFOM GS/FS

**REPLACEMENT LOCK
WITH 2 KEYS****ORD. NO.****R CSR 0029 00**

KEY WITH NUMBER FROM

25000 - 26999

**PAIR OF REPLACEMENT RODS WITH ACCESSORIES****ORD. NO.****R XAN 0002 99**

SUITABLE FOR LOCKERS SERIES

F AN 1700

REPLACEMENT LOCKS**ORD. NO.****R CSC 0004 00****R CSC 0002 00**

KEY WITH NUMBER FROM

25000 - 26999

45000 - 46999



Always specify the number indicated on the cylinder lock when ordering replacement keys.



ATA' FILM

THRILLER A

AZIONI





ORGANIZE SPACE

LET'S REORG



- **TOOL HOLDER SYSTEM SERIES NC**

NORMAL EXTENSION DRAWERS 87%

FULL EXTENSION DRAWERS 100%

VERSATILE

SEVERAL SERIES AVAILABLE

ORGANIZE SPACE LET'S REOR

SERIES NC

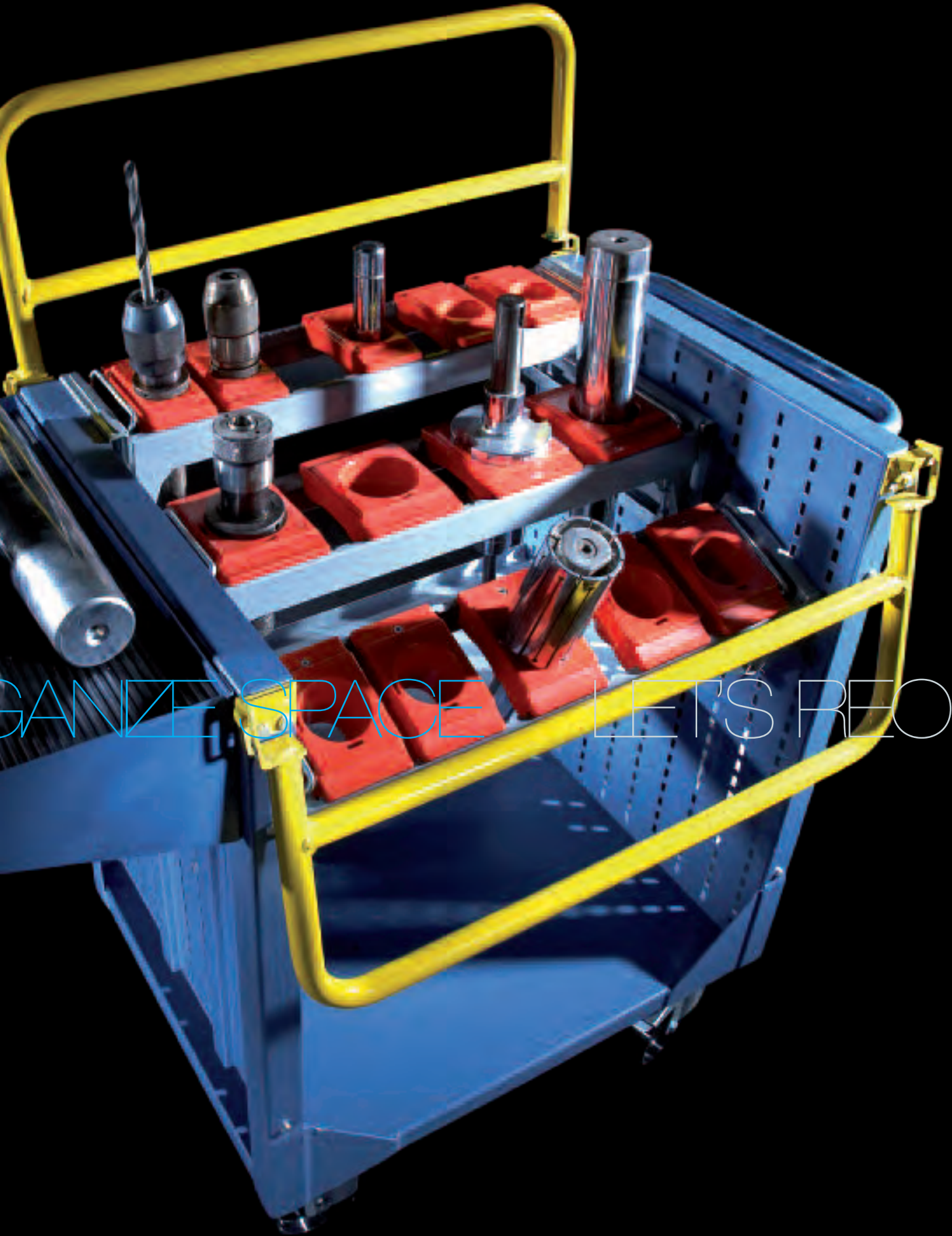

TOOL HOLDERS SERIES NC-TOOL

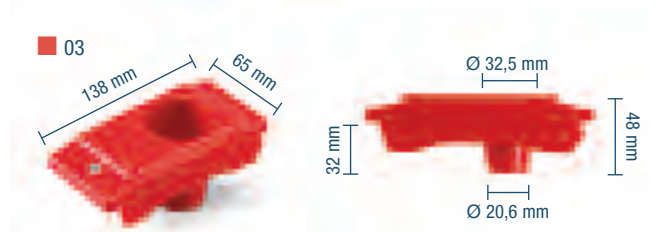

ORD. NO.

PACKAGE OF

DIMENSIONS mm

F NC 9510 00 03

1 PIECE

65x138x48 h**F NC 9510 01 03**

10 PIECES

65x138x48 h

Tool holder ISO 30

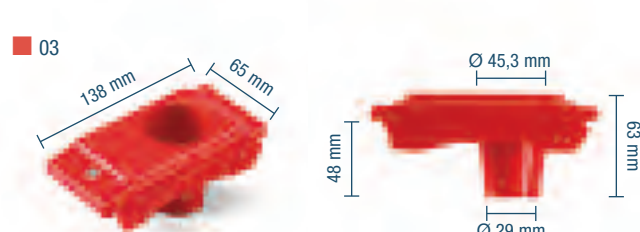

ORD. NO.

PACKAGE OF

DIMENSIONS mm

F NC 9530 00 03

1 PIECE

65x138x63 h**F NC 9530 01 03**

10 PIECES

65x138x63 h

Tool holder ISO 40

RED F. 03

INFO ■

www.famispa.com

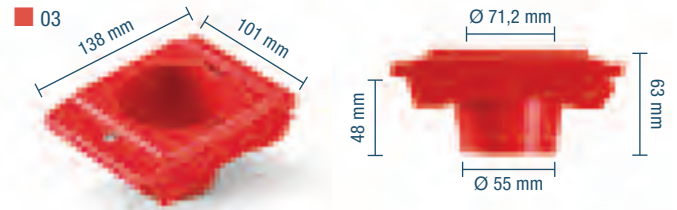
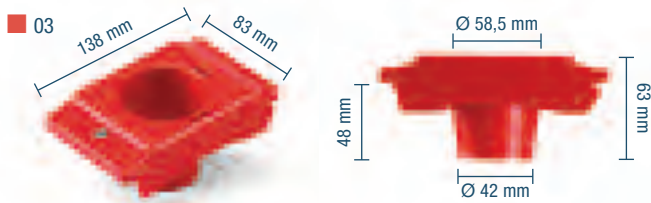



ORD. NO.	PACKAGE OF	DIMENSIONS mm
F NC 9540 00 03	1 PIECE	83x138x63 h
F NC 9540 01 03	10 PIECES	83x138x63 h

Tool holder ISO 45

ORD. NO.	PACKAGE OF	DIMENSIONS mm
F NC 9550 00 03	1 PIECE	101x138x63 h
F NC 9550 01 03	10 PIECES	101x138x63 h

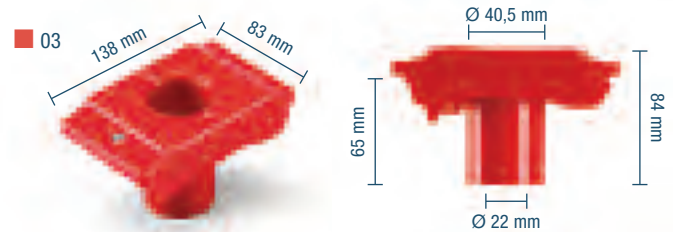
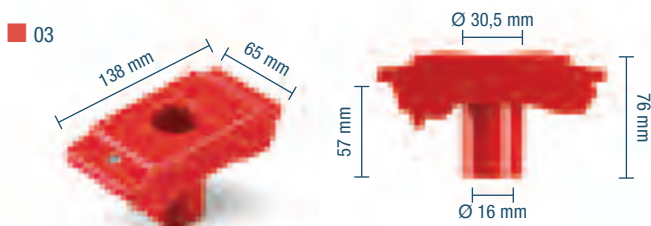
Tool holder ISO 50



ORD. NO.	PACKAGE OF	DIMENSIONS mm
F NC 9560 00 03	1 PIECE	65x138x76 h
F NC 9560 01 03	24 PIECES	65x138x76 h

Tool holder VDI 30

ORD. NO.	PACKAGE OF	DIMENSIONS mm
F NC 9570 00 03	1 PIECE	83x138x84 h
F NC 9570 01 03	24 PIECES	83x138x84 h

Tool holder VDI 40

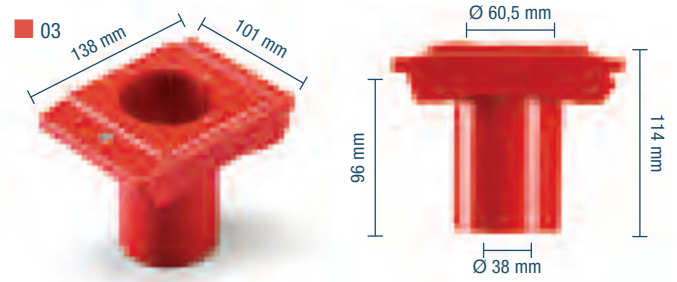
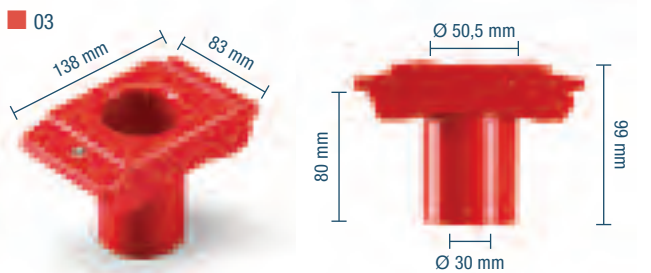

ORD. NO.	PACKAGE OF	DIMENSIONS mm
F NC 9580 00 03	1 PIECE	83x138x99 h
F NC 9580 01 03	16 PIECES	83x138x99 h

Tool holder VDI 50

ORD. NO.	PACKAGE OF	DIMENSIONS mm
F NC 9590 00 03	1 PIECE	101x138x114 h
F NC 9590 01 03	16 PIECES	101x138x114 h

Tool holder VDI 60

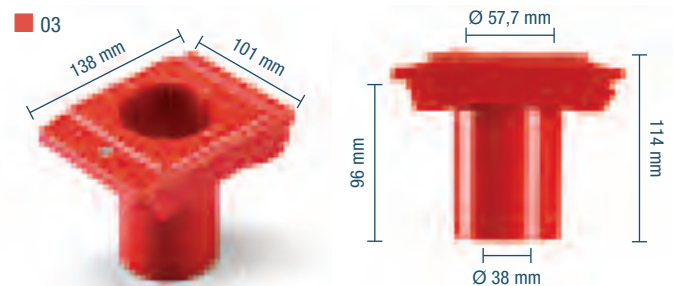
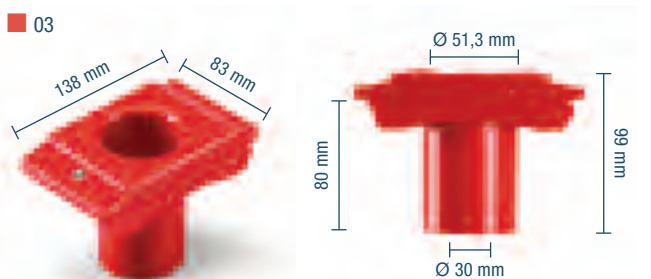

ORD. NO.	PACKAGE OF	DIMENSIONS mm
F NC 9640 00 03	1 PIECE	83x138x99 h
F NC 9640 01 03	24 PIECES	83x138x99 h

Tool holder 2"

ORD. NO.	PACKAGE OF	DIMENSIONS mm
F NC 9650 00 03	1 PIECE	101x138x114 h
F NC 9650 01 03	16 PIECES	101x138x114 h

Tool holder 2" 1/4

■ INFO



www.famispa.com

RED F. 03

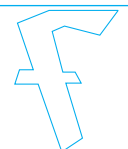

TOOL HOLDERS SERIES NC-TOOL

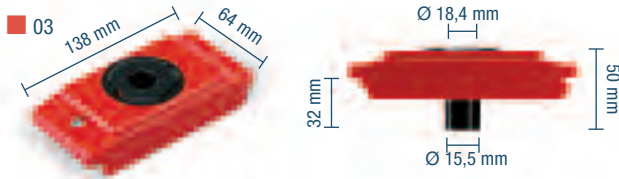

ORD. NO.	PACKAGE OF	DIMENSIONS mm
F NC 9720 00 03	1 PIECE	64x138x50 h
F NC 9720 01 03	4 PIECES	64x138x50 h

Tool holder **MORSE TAPER 2**

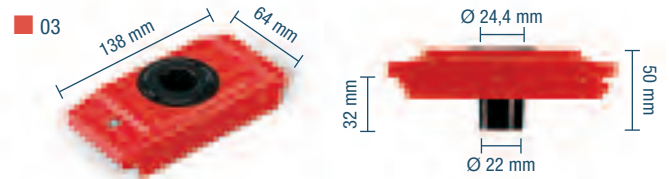

ORD. NO.	PACKAGE OF	DIMENSIONS mm
F NC 9730 00 03	1 PIECE	64x138x50 h
F NC 9730 01 03	4 PIECES	64x138x50 h

Tool holder **MORSE TAPER 3**

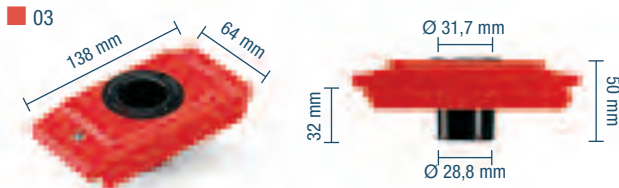

ORD. NO.	PACKAGE OF	DIMENSIONS mm
F NC 9740 00 03	1 PIECE	64x138x50 h
F NC 9740 01 03	4 PIECES	64x138x50 h

Tool holder **MORSE TAPER 4**

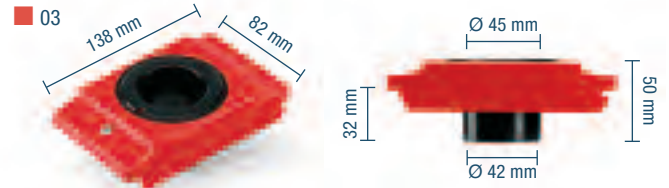

ORD. NO.	PACKAGE OF	DIMENSIONS mm
F NC 9750 00 03	1 PIECE	82x138x50 h
F NC 9750 01 03	4 PIECES	82x138x50 h

Tool holder **MORSE TAPER 5**

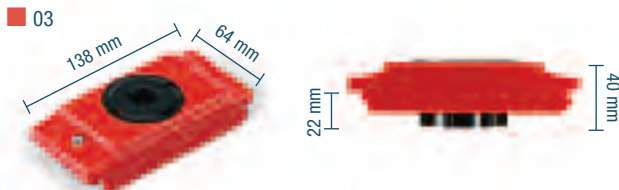

ORD. NO.	PACKAGE OF	DIMENSIONS mm
F NC 9270 00 03	1 PIECE	64x138x40 h
F NC 9270 01 03	10 PIECES	64x138x40 h

Tool holder **CAPTO C3**

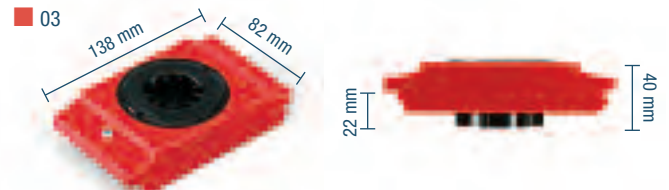

ORD. NO.	PACKAGE OF	DIMENSIONS mm
F NC 9275 00 03	1 PIECE	82x138x40 h
F NC 9275 01 03	10 PIECES	82x138x40 h

Tool holder **CAPTO C4**

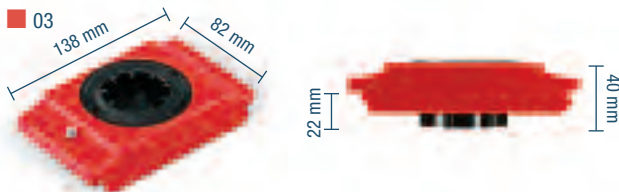

ORD. NO.	PACKAGE OF	DIMENSIONS mm
F NC 9280 00 03	1 PIECE	82x138x40 h
F NC 9280 01 03	10 PIECES	82x138x40 h

Tool holder **CAPTO C5**

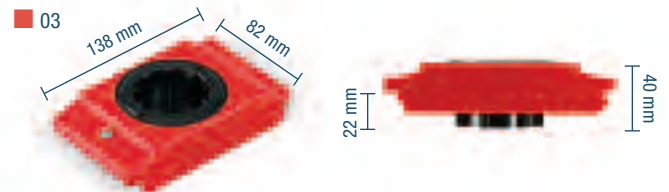

ORD. NO.	PACKAGE OF	DIMENSIONS mm
F NC 9285 00 03	1 PIECE	82x138x40 h
F NC 9285 01 03	10 PIECES	82x138x40 h

Tool holder **CAPTO C6**

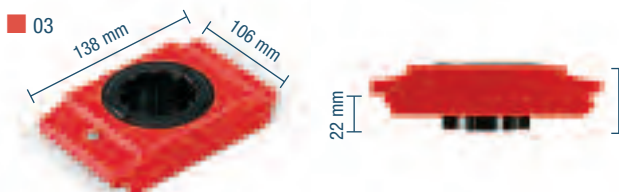

ORD. NO.	PACKAGE OF	DIMENSIONS mm
F NC 9290 00 03	1 PIECE	106x138x40 h
F NC 9290 01 03	10 PIECES	106x138x40 h

Tool holder **CAPTO C8**

RED F. 03



INFO ■

www.famispa.com



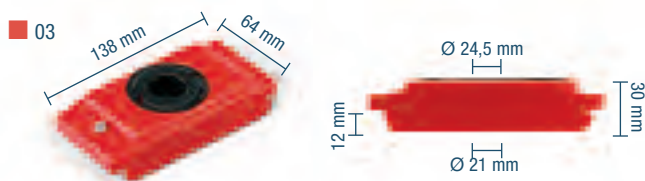

ORD. NO.	PACKAGE OF	DIMENSIONS mm H
F NC 9210 00 03	1 PIECE	64x138x30
F NC 9210 01 03	10 PIECES	64x138x30

Tool holder **HSK A32-B40**

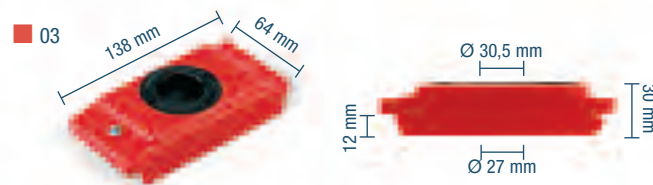

ORD. NO.	PACKAGE OF	DIMENSIONS mm
F NC 9220 00 03	1 PIECE	64x138x30 h
F NC 9220 01 03	10 PIECES	64x138x30 h

Tool holder **HSK A40-B50**

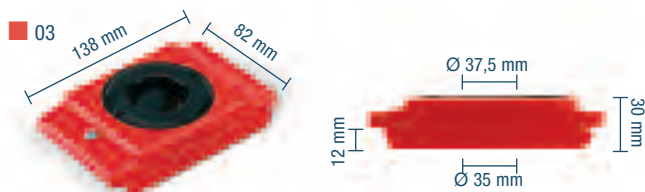

ORD. NO.	PACKAGE OF	DIMENSIONS mm
F NC 9230 00 03	1 PIECE	82x138x30 h
F NC 9230 01 03	10 PIECES	82x138x30 h

Tool holder **HSK A50-B63**

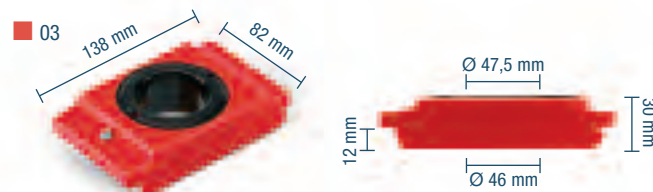

ORD. NO.	PACKAGE OF	DIMENSIONS mm
F NC 9240 00 03	1 PIECE	82x138x30 h
F NC 9240 01 03	10 PIECES	82x138x30 h

Tool holder **HSK A63-B80**

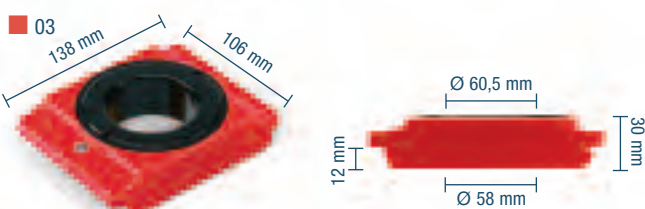

ORD. NO.	PACKAGE OF	DIMENSIONS mm
F NC 9250 00 03	1 PIECE	106x138x30 h
F NC 9250 01 03	10 PIECES	106x138x30 h

Tool holder **HSK A80-B100**

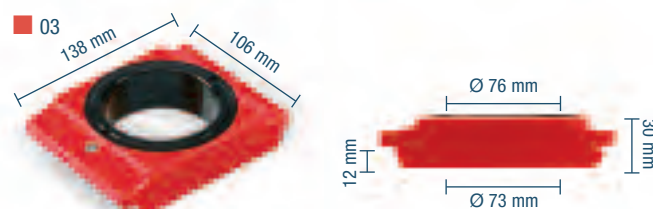

ORD. NO.	PACKAGE OF	DIMENSIONS mm
F NC 9260 00 03	1 PIECE	106x138x30 h
F NC 9260 01 03	10 PIECES	106x138x30 h

Tool holder **HSK A100-B125**

CABINET WITH LEAF DOORS

ORD. NO.

F AE 3040 S1 50

Including 4 drawers

2 tool holder frames with supports

1 cover MDF top

Dimensions mm 717x750x1030 h

Tools and tool holders excluded



■ RAL 7035 +
■ RAL 5012

■ **INFO**



www.famispa.com

RED F. 03

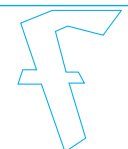

TOOL HOLDERS SERIES NC-TOOL

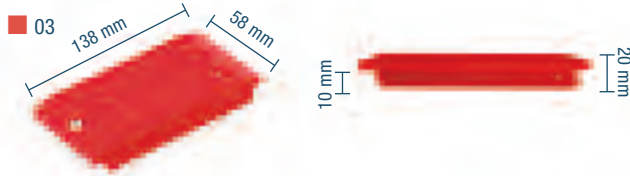

ORD. NO.	PACKAGE OF	DIMENSIONS mm
F NC 9010 00 03	1 PIECE	58x138x20 h
F NC 9010 01 03	10 PIECES	58x138x20 h

Tool holder **58 mm**

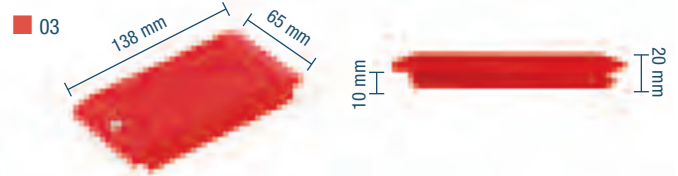

ORD. NO.	PACKAGE OF	DIMENSIONS mm
F NC 9020 00 03	1 PIECE	65x138x20 h
F NC 9020 01 03	10 PIECES	65x138x20 h

Tool holder **65 mm**

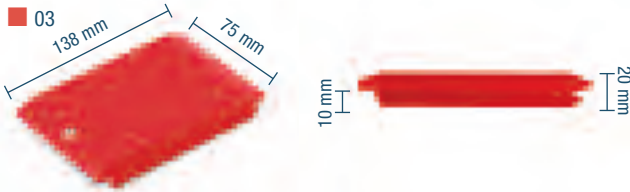

ORD. NO.	PACKAGE OF	DIMENSIONS mm
F NC 9030 00 03	1 PIECE	75x138x20 h
F NC 9030 01 03	10 PIECES	75x138x20 h

Tool holder **75 mm**

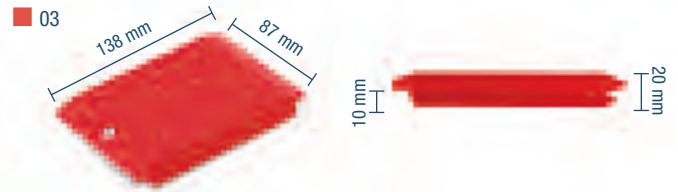

ORD. NO.	PACKAGE OF	DIMENSIONS mm
F NC 9040 00 03	1 PIECE	87x138x20 h
F NC 9040 01 03	10 PIECES	87x138x20 h

Tool holder **87 mm**

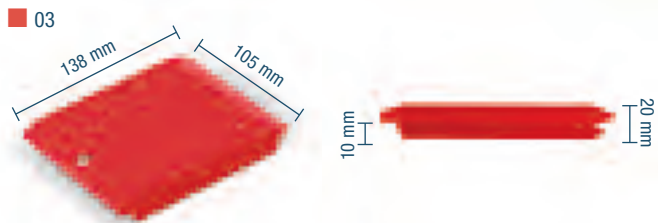

ORD. NO.	PACKAGE OF	DIMENSIONS mm
F NC 9050 00 03	1 PIECE	105x138x20 h
F NC 9050 01 03	10 PIECES	105x138x20 h

Tool holder **105 mm**



ORD. NO. TOOL HOLDERS	TOOL HOLDER TYPE	MAX. QUANTITY PER TOOL FRAME F NC 2010 00 ..
F NC 9510 00 03	ISO 30	24
F NC 9530 00 03	ISO 40	24
F NC 9540 00 03	ISO 45	18
F NC 9550 00 03	ISO 50	15
F NC 9560 00 03	VDI 30	24
F NC 9570 00 03	VDI 40	18
F NC 9580 00 03	VDI 50	18
F NC 9590 00 03	VDI 60	15
F NC 9720 00 03	MORSE TAPER 2	24
F NC 9730 00 03	MORSE TAPER 3	24
F NC 9740 00 03	MORSE TAPER 4	24
F NC 9750 00 03	MORSE TAPER 5	18
F NC 9270 00 03	CAPTO C3	24
F NC 9275 00 03	CAPTO C4	18
F NC 9280 00 03	CAPTO C5	18



ORD. NO. TOOL HOLDERS	TOOL HOLDER TYPE	MAX. QUANTITY PER TOOL FRAME F NC 2010 00 ..
F NC 9285 00 03	CAPTO C6	18
F NC 9290 00 03	CAPTO C8	12
F NC 9210 00 03	HSK A32-B40	24
F NC 9220 00 03	HSK A40-B50	24
F NC 9230 00 03	HSK A50-B63	18
F NC 9240 00 03	HSK A63-B80	18
F NC 9250 00 03	HSK A80-B100	12
F NC 9260 00 03	HSK A100-B125	12
F NC 9640 00 03	2"	18
F NC 9650 00 03	2" 1/4	15
F NC 9010 00 03	58 mm	27
F NC 9020 00 03	65 mm	24
F NC 9030 00 03	75 mm	21
F NC 9040 00 03	87 mm	18
F NC 9050 00 03	105 mm	15

RED F. 03



INFO

www.famispa.com



TOOL STAND**ORD. NO.****F NC 2010 00 04****Dimensions mm 565x450x350 h**

Tool holders excluded

- 01
- 02
- 04
- 08



■ RAL 1004

- RAL 5012 +
- RAL 7000

ORD. NO.**F CN 5720 00 30**

Pair of side protections ■ RAL 1004

Dimensions mm 988x270 h**TOOL TROLLEY****ORD. NO.****F CN K600 10 51**

Including 1 frame with 4-rows

1 pair of carriers for frame 4-rows

6 frames with 1-row

4 angled carriers for frames with 1-row

2 horizontal carriers for frames with 1-row

Dimensions mm 1073x685x935 h

Tools and tool holders excluded

CABINET WITH SLIDING DOORS**ORD. NO.****F AF 1040 S1 08**

Including 4 drawers, 2 retractable shelves

2 tool holder frames

1 rubber cover top with 3 edges

Dimensions mm 1431x632x1020 h

Tools and tool holders excluded



■ RAL 7035

TROLLEY SERIES NC-COMBI



ORD. NO. F CN K600 06 51
RAL 5012+7000

ORD. NO. F CN F100 06 51
RAL 5012+7000

TOOL TROLLEY

ORD. NO.

F CN F100 06 51

Dimensions mm 1064x512x890 h

Tool holders excluded

TOOL TROLLEY

ORD. NO.

F CN K600 06 51

Dimensions mm 1073x685x935h

Tool holders excluded

ORD. NO.

F CN 5710 00 30

Pair of side protections ■ RAL 1004

Dimensions mm 690x270 h

TOOL TROLLEY

ORD. NO.

F CN F100 10 51

Dimensions mm 1064x512x890 h

Tool holders excluded



- RAL 7000 F.01
- RAL 6011 F.02
- RAL 5012 + RAL 7000 F.51
- RAL 7035 + RAL 7000 F.56

KEY ■

■ Partitioning material: see page B47

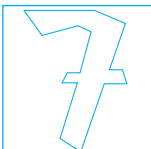

LENGTH = 1064 mm DEPTH = 512 mm

TROLLEY SERIES NC-COMBI

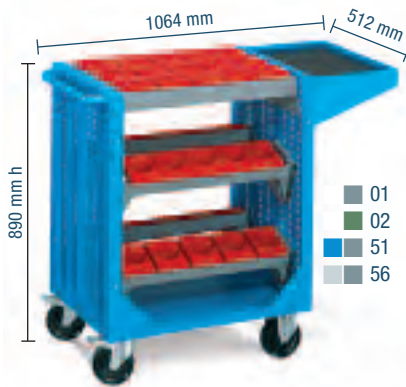

ORD. NO.	TROLLEY LOAD CAPACITY kg
F CN F100 01 51	500
Including:	
2 nylon swivel wheels with brake Ø 125 mm	
2 nylon fixed wheels Ø 125 mm	
1 tool holder frame 3-rows ORD. NO. F NC 5120 00 01	
1 pair of carriers ORD. NO. F NC 5620 00 01	
4 tool holder frames 1-row ORD. NO. F NC 5020 00 01	
4 pair of angled carriers ORD. NO. F NC 5711 00 99	
1 shelf ORD. NO. F CN 5510 00 04	
1 rubber mat ORD. NO. F CN 5210 00 07	
Dimensions mm 1064x512x890 h	
Tool holders excluded	

ORD. NO.	TROLLEY LOAD CAPACITY kg
F CN F100 06 51	500
Including:	
2 nylon swivel wheels with brake Ø 125 mm	
2 nylon fixed wheels Ø 125 mm in	
5 tool holder frames 1-row ORD. NO. F NC 5020 00 01	
4 pair of angled carriers ORD. NO. F NC 5711 00 99	
1 pair of horizontal carriers ORD. NO. F NC 5710 00 99	
1 shelf ORD. NO. F CN 5510 00 04	
1 rubber mat ORD. NO. F CN 5210 00 07	
1 adjustable shelf ORD. NO. F CN 5100 00 01	
1 rubber mat ORD. NO. F CN 5220 00 07	
Dim. mm 1064x512x890 h Tool holders excluded	

ORD. NO.	TROLLEY LOAD CAPACITY kg
F CN F100 10 51	500
Including:	
2 nylon swivel wheels with brake Ø 125 mm	
2 nylon fixed wheels Ø 125 mm	
1 tool holder frame 3-rows ORD. NO. F NC 5120 00 01	
1 pair of carriers ORD. NO. F NC 5620 00 01	
2 tool holder frames 1-row ORD. NO. F NC 5020 00 01	
2 pair of angled carriers ORD. NO. F NC 5711 00 99	
1 shelf ORD. NO. F CN 5510 00 04	
1 rubber mat ORD. NO. F CN 5210 00 07	
Dimensions mm 1064x512x890 h	
Tool holders excluded	

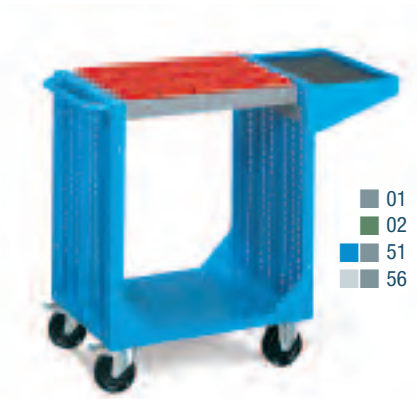

ORD. NO.	TROLLEY LOAD CAPACITY kg
F CN F100 07 51	500
Including:	
2 nylon swivel wheels with brake Ø 125 mm	
2 nylon fixed wheels Ø 125 mm	
4 tool holder frames 1-row ORD. NO. F NC 5020 00 01	
4 pair of angled carriers ORD. NO. F NC 5711 00 99	
1 shelf ORD. NO. F CN 5510 00 04	
1 rubber mat ORD. NO. F CN 5210 00 07	
Dimensions mm 1064x512x890 h	
Tool holders excluded	

ORD. NO.	TROLLEY LOAD CAPACITY kg
F CN F100 11 51	500
Including:	
2 nylon swivel wheels with brake Ø 125 mm	
2 nylon fixed wheels Ø 125 mm	
5 tool holder frames 1-row ORD. NO. F NC 5020 00 01	
4 pair of angled carriers ORD. NO. F NC 5711 00 99	
1 pair of horizontal carriers ORD. NO. F NC 5710 00 99	
1 shelf ORD. NO. F CN 5510 00 04	
1 rubber mat ORD. NO. F CN 5210 00 07	
Dim. mm 1064x512x890 h Tool holders excluded	

ORD. NO.	TROLLEY LOAD CAPACITY kg
F CN F100 08 51	500
Including:	
2 nylon swivel wheels with brake Ø 125 mm	
2 nylon fixed wheels Ø 125 mm	
1 tool holder frame 3-rows ORD. NO. F NC 5120 00 01	
1 pair of carriers ORD. NO. F NC 5620 00 01	
1 shelf ORD. NO. F CN 5510 00 04	
1 rubber mat ORD. NO. F CN 5210 00 07	
Dimensions mm 1064x512x890 h	
Tool holders excluded	

KEY

RAL 7000 F.01 RAL 6011 F.02 RAL 5012 + RAL 7000 F.51 RAL 7035 + RAL 7000 F.56



- Tool holders: see page B11
- All indicated loads are net and refer to evenly distributed weights.

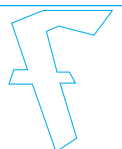

TROLLEY SERIES NC-COMBI

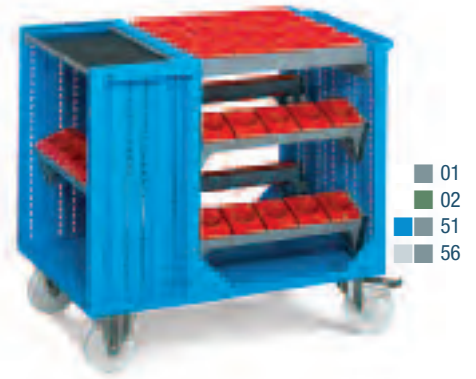
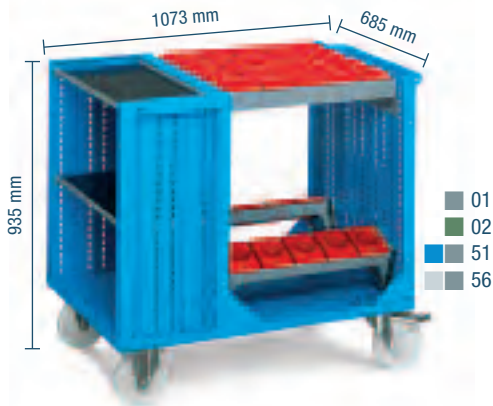

ORD. NO.	TROLLEY LOAD CAPACITY kg
F CN K600 08 51	840
Including:	
2 nylon swivel wheels with brake Ø 160 mm	
2 nylon fixed wheels Ø 160 mm	
1 tool holder frame 4-rows ORD. NO. F NC 5220 00 01	
1 pair of carriers ORD. NO. F NC 5640 00 01	
2 tool holder frames 1-row ORD. NO. F NC 5020 00 01	
2 pair of angled carriers ORD. NO. F NC 5711 00 99	
2 adjustable shelves ORD. NO. F CN 5100 00 01	
2 rubber mat ORD. NO. F CN 5220 00 07	
Dimensions mm 1073x685x935 h	
Tool holders excluded	

ORD. NO.	TROLLEY LOAD CAPACITY kg
F CN K600 10 51	840
Including:	
2 nylon swivel wheels with brake Ø 160 mm	
2 nylon fixed wheels Ø 160 mm	
1 tool holder frame 4-rows ORD. NO. F NC 5220 00 01	
1 pair of carriers ORD. NO. F NC 5640 00 01	
6 tool holder frames 1-row ORD. NO. F NC 5020 00 01	
4 pair of angled carriers ORD. NO. F NC 5711 00 99	
2 pair of horizontal carriers ORD. NO. F NC 5710 00 99	
Dimensions mm 1073x685x935 h	
Tool holders excluded	

ORD. NO.	TROLLEY LOAD CAPACITY kg
F CN K600 09 51	840
Including:	
2 nylon swivel wheels with brake Ø 160 mm	
2 nylon fixed wheels Ø 160 mm	
1 tool holder frame 4-rows ORD. NO. F NC 5220 00 01	
1 pair of carriers ORD. NO. F NC 5640 00 01	
5 tool holder frames 1-row ORD. NO. F NC 5020 00 01	
5 pair of angled carriers ORD. NO. F NC 5711 00 99	
1 adjustable shelf ORD. NO. F CN 5100 00 01	
1 rubber mat ORD. NO. F CN 5220 00 07	
Dimensions mm 1073x685x935 h	
Tool holders excluded	

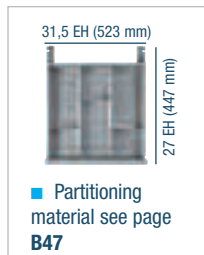

ORD. NO.	TROLLEY LOAD CAPACITY kg
F CN K600 06 51	840
Including:	
2 nylon swivel wheels with brake Ø 160 mm	
2 nylon fixed wheels Ø 160 mm	
1 tool holder frame 4-rows ORD. NO. F NC 5220 00 01	
1 pair of carriers ORD. NO. F NC 5640 00 01	
4 tool holder frames 1-row ORD. NO. F NC 5020 00 01	
2 pair of angled carriers ORD. NO. F NC 5711 00 99	
2 pair of horizontal carriers ORD. NO. F NC 5710 00 99	
1 adjustable shelf ORD. NO. F CN 5120 00 01	
1 rubber mat ORD. NO. F CN 5240 00 07	
2 adjustable shelves ORD. NO. F CN 5100 00 01	
2 rubber mat ORD. NO. F CN 5220 00 07	
1 empty drawer ORD. NO. F NC 8610 00 04	
Dim. mm 1073x685x935 h Tool holders excluded	

RAL 7000 F.01
RAL 6011 F.02
RAL 5012 + RAL 7000 F.51
RAL 7035 + RAL 7000 F.56

KEY ■

■ All indicated loads are net and refer to evenly distributed weights.

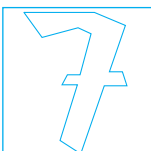

TROLLEY SERIES NC-COMBI



ORD. NO. TOOL HOLDERS	TOOL HOLDER TYPE	MAX. QUANTITY PER TOOL FRAME F NC 5020 00 ..	MAX. QUANTITY PER TOOL FRAME F NC 5120 00 ..	MAX. QUANTITY PER TOOL FRAME F NC 5220 00 ..
F NC 9510 00 03	ISO 30	7	24	32
F NC 9530 00 03	ISO 40	7	24	32
F NC 9540 00 03	ISO 45	5	18	24
F NC 9550 00 03	ISO 50	5	15	20
F NC 9560 00 03	VDI 30	7	24	32
F NC 9570 00 03	VDI 40	5	18	24
F NC 9580 00 03	VDI 50	5	18	24
F NC 9590 00 03	VDI 60	5	15	20
F NC 9720 00 03	MORSE TAPER 2	7	24	32
F NC 9730 00 03	MORSE TAPER 3	7	24	32
F NC 9740 00 03	MORSE TAPER 4	7	24	32
F NC 9750 00 03	MORSE TAPER 5	5	18	24
F NC 9270 00 03	CAPTO C3	7	24	32
F NC 9275 00 03	CAPTO C4	5	18	24
F NC 9280 00 03	CAPTO C5	5	18	24
F NC 9285 00 03	CAPTO C6	5	18	24
F NC 9290 00 03	CAPTO C8	4	12	16
F NC 9210 00 03	HSK A32-B40	7	24	32
F NC 9220 00 03	HSK A40-B50	7	24	32
F NC 9230 00 03	HSK A50-B63	5	18	24
F NC 9240 00 03	HSK A63-B80	5	18	24
F NC 9250 00 03	HSK A80-B100	4	12	16
F NC 9260 00 03	HSK A100-B125	4	12	16
F NC 9640 00 03	2"	5	18	24
F NC 9650 00 03	2" 1/4	5	15	20
F NC 9010 00 03	58 mm	9	27	36
F NC 9020 00 03	65 mm	8	24	32
F NC 9030 00 03	75 mm	7	21	28
F NC 9040 00 03	87 mm	6	18	24
F NC 9050 00 03	105 mm	5	15	20



■ INFO

RAL 7000 F.01 RAL 6011 F.02 RAL 5012 + RAL 7000 F.51 RAL 7035 + RAL 7000 F.56



www.famispa.com

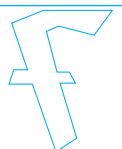

TROLLEY SERIES NC-COMBI

TOOL TROLLEY F CN 0100 (NC102)

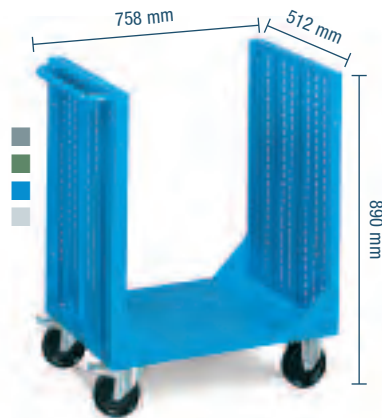

ORD. NO. TROLLEY LOAD CAPACITY kg

F CN F100 00 04 500

Including: 2 nylon swivel wheels with brake Ø 125 mm,
2 nylon fixed wheels Ø 125 mm

Dimensions mm 758x512x890 h

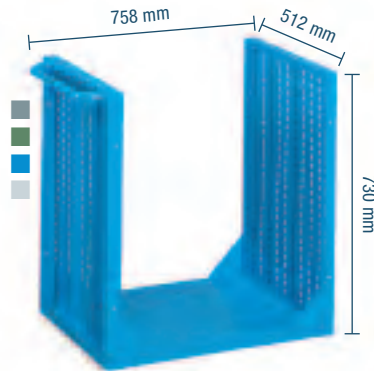

ORD. NO.

F CN 0100 00 04

Trolley prepared for wheels:
Ø 100 mm / 125 mm / 150 mm

Dimensions mm 758x512x730 h

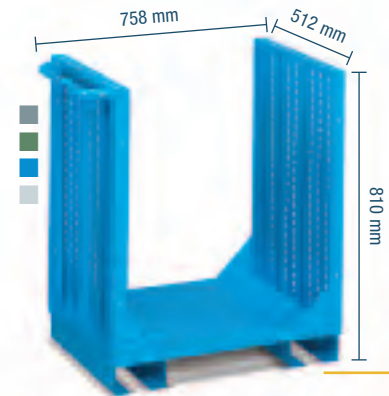

ORD. NO.

F CN 0101 00 04

Including: 2 fork lift base prepared for wheels
Ø 100 mm / 125 mm / 150 mm

Dimensions mm 758x512x810 h

1 ORD. NO. F CN 5210 00 07

Rubber mat for shelf

ORD. NO. F CN 5510 00 ..

Overall dimensions mm: 485x300

2 ORD. NO. F CN 5510 00 01 ■ RAL 7000

2 ORD. NO. F CN 5510 00 02 ■ RAL 6011

2 ORD. NO. F CN 5510 00 04 ■ RAL 5012

2 ORD. NO. F CN 5510 00 08 ■ RAL 7035

Shelf dimensions mm: 490x300x170 h

3 ORD. NO. F CN 5220 00 07

Rubber mat for adjustable shelf

ORD. NO. F CN 5100 00 ..

Overall dimensions mm: 595x295

4 ORD. NO. F CN 5100 00 01 ■ RAL 7000

4 ORD. NO. F CN 5100 00 02 ■ RAL 6011

Height adjustable shelf

Overall dimensions mm: 600x300x42 h

Load capacity: 30 kg

5 ORD. NO. F CN 5250 00 07

Rubber mat for bottom shelf of trolley

ORD. NO. F CN 5110 00 ..

Overall dimensions mm: 595x495

6 ORD. NO. F CN 5230 00 07

Rubber mat for adjustable shelf

ORD. NO. F CN 5110 00 ..

Overall dimensions mm: 595x455

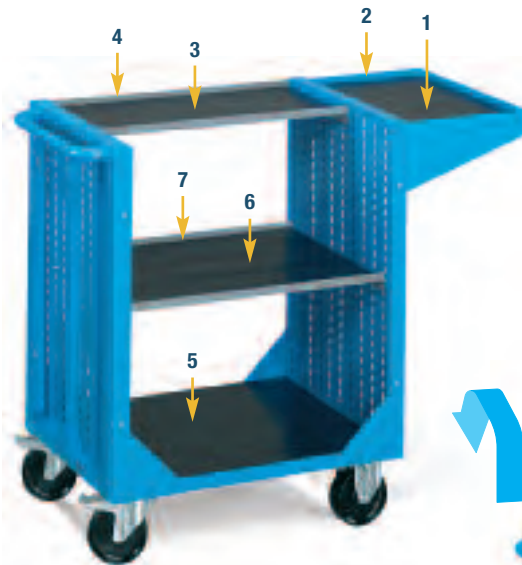

7 ORD. NO. F CN 5110 00 01 ■ RAL 7000

7 ORD. NO. F CN 5110 00 02 ■ RAL 6011

Height adjustable shelf

Overall dimensions mm: 600x460x42 h

Load capacity: 30 kg

8+9 ORD. NO. F CN 5710 00 30 ■ RAL 1004

Pair of side protections for trolley series CN 0100

Overall dimensions mm: 690x270 h

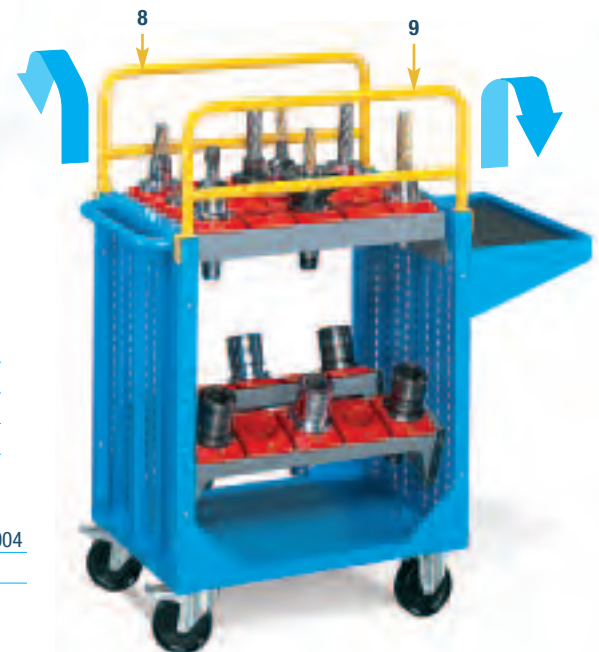

RAL 7000 F.01 ■ RAL 6011 F.02 ■ RAL 5012 F.04 ■ RAL 7035 F.08 ■

KEY ■

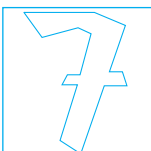

■ Wheels see page B18

■ All indicated loads are net and refer to evenly distributed weights.



LENGTH = 1073 mm DEPTH = 685 mm

TROLLEY SERIES NC-COMBI

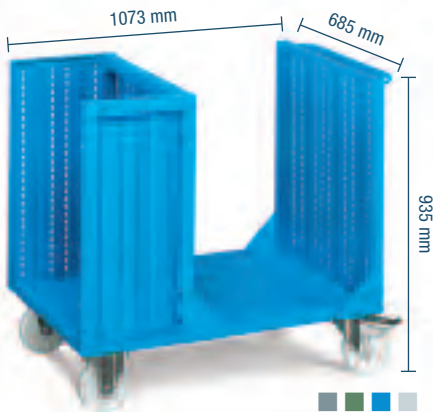

ORD. NO. TROLLEY LOAD CAPACITY kg

F CN K600 00 04 840

Including: 2 nylon swivel wheels with brake Ø 160 mm,
2 fixed wheels Ø 160 mm in nylon

Dimensions mm 1073x685x935 h

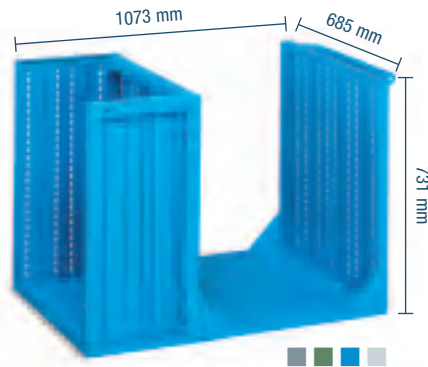

ORD. NO.

F CN 0600 00 04

Trolley prepared for wheels: Ø 160 mm / 200 mm

Dimensions mm 1073x685x731 h

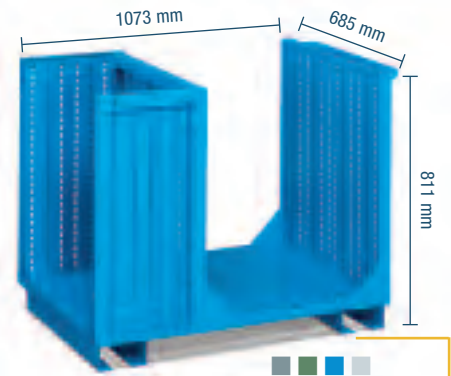

ORD. NO.

F CN 0601 00 04

Including: 2 fork lift base prepared for wheels
Ø 160 mm / 200 mm

Dimensions mm 1073x685x811 h

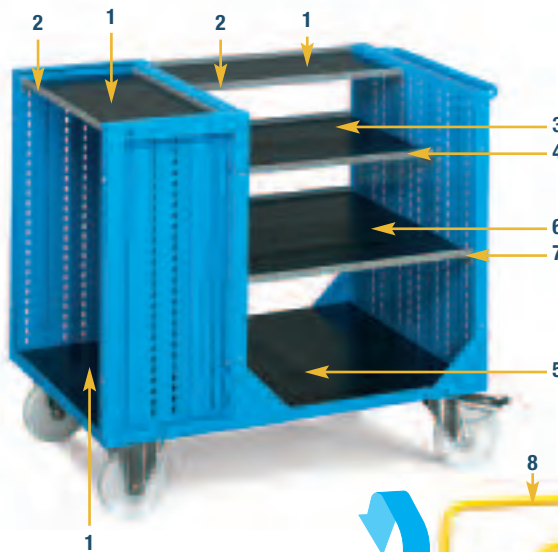

1 ORD. NO. F CN 5220 00 07

Rubber mat for adjustable shelf

ORD. NO. F CN 5100 00 ..

Overall dimensions mm: 595x295

2 ORD. NO. F CN 5100 00 01 ■ RAL 7000

2 ORD. NO. F CN 5100 00 02 ■ RAL 6011

Height adjustable shelf

Overall dimensions mm: 600x300x42 h

Load capacity: 30 kg

3 ORD. NO. F CN 5230 00 07

Rubber mat for adjustable shelf

ORD. NO. F CN 5110 00 ..

Overall dimensions mm: 595x455

4 ORD. NO. F CN 5110 00 01 ■ RAL 7000

4 ORD. NO. F CN 5110 00 02 ■ RAL 6011

Height adjustable shelf

Overall dimensions mm: 600x460x42 h

Load capacity: 30 kg

5 ORD. NO. F CN 5260 00 07

Rubber mat for bottom shelf of

trolley

Overall dimensions mm: 675x595

6 ORD. NO. F CN 5240 00 07

Rubber mat for adjustable shelf

ORD. NO. F CN 5120 00 ..

Overall dimensions mm: 595x655

7 ORD. NO. F CN 5120 00 01 ■ RAL 7000

7 ORD. NO. F CN 5120 00 02 ■ RAL 6011

Height adjustable shelf

Overall dimensions mm: 600x660x42 h

Load capacity: 30 kg

8+9 ORD. NO. F CN 5720 00 30 ■ RAL 1004

Pair of side protections per carrello

serie CN 0600

Overall dimensions mm: 988x270 h

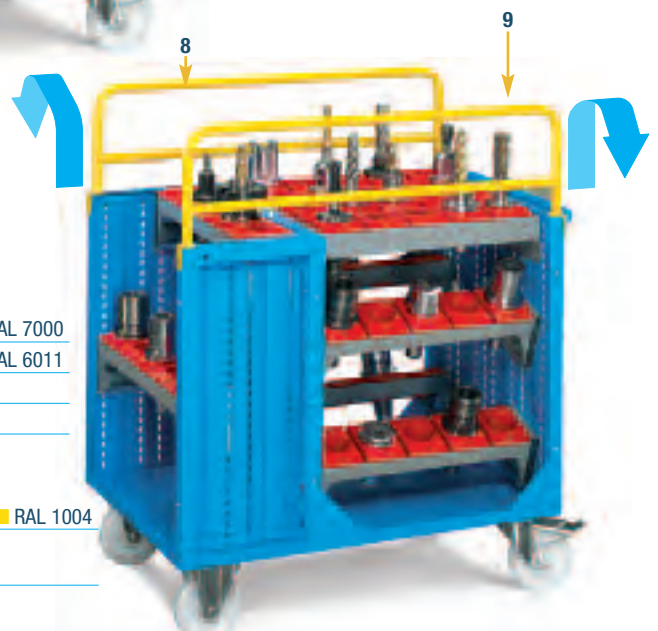

■ KEY

■ RAL 7000 F.01

■ RAL 6011 F.02

■ RAL 5012 F.04

■ RAL 7035 F.08

■ Wheels see
page B19



■ All indicated loads are net and refer to evenly distributed weights.

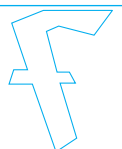

TROLLEY SERIES NC-COMBI

TOOL HOLDER FRAME AND ACCESSORIES FOR TOOL TROLLEY F CN 0100 (NC102) / F CN 0600 (NC104)



■ 01
■ 02

TOOL HOLDER FRAME

ORD. NO.

F NC 5020 00 01

Horizontal frame load capacity: 50 kg

Dimensions mm 584x140x146 h



■ 99

PAIR OF GALVANISED HANDLES

ORD. NO.

F NC 5005 00 99

For frame ORD. NO. F NC 5020 00 ..



■ 99

PAIR OF GALVANISED TOOL HOLDER FRAME CARRIERS, HORIZONTAL

ORD. NO.

F NC 5710 00 99

For frame ORD. NO. F NC 5020 00 ..

Overall dimensions mm 140x150 h



■ 99

PAIR OF GALVANISED TOOL HOLDER FRAME CARRIERS, ANGLED

ORD. NO.

F NC 5711 00 99

For frame ORD. NO. F NC 5020 00 ..

Overall dimensions mm 140x150 h

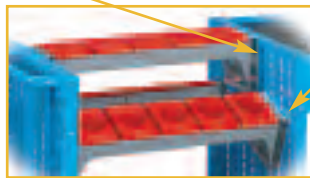

TOOL HOLDER FRAME 3-ROWS AND ACCESSORIES FOR TROLLEYS F CN 0100 (NC102)



■ 01
■ 02

TOOL HOLDER FRAME 3-ROWS

ORD. NO.

F NC 5120 00 01

Horizontal frame load capacity: 150 kg

Overall dimensions mm 584x444x69 h

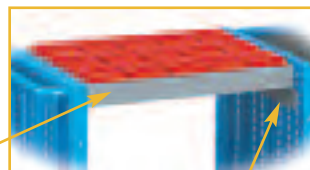

■ 01
■ 02

HORIZONTAL PAIR OF CARRIERS

ORD. NO.

F NC 5620 00 01

For frame ORD. NO. F NC 5120 00 ..

Overall dimensions mm 430x112 h



■ 01
■ 02

ANGLED PAIR OF CARRIERS

ORD. NO.

F NC 5721 00 01

For frame ORD. NO. F NC 5120 00 ..

Overall dimensions mm 430x114 h

RAL 7000 F.01 RAL 6011 F.02 ZINCATO F.99

KEY ■

■ All indicated loads are net and refer to evenly distributed weights.

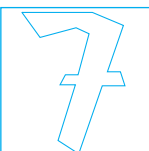

TOOL HOLDER FRAME 4-ROWS AND ACCESSORIES FOR TROLLEYS F CN 0600 (NC104)

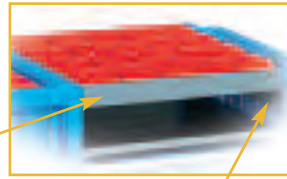

TOOL HOLDER FRAME 4 ROWS

ORD. NO.

F NC 5220 00 01

Horizontal frame load capacity: 150 kg

Overall dimensions mm 584x592x69 h

HORIZONTAL PAIR OF CARRIERS

ORD. NO.

F NC 5640 00 01

For frame ORD. NO. F NC 5220 00 ..

Overall dimensions mm 577x112 h

ANGLED PAIR OF CARRIERS

ORD. NO.

F NC 5741 00 01

For frame ORD. NO. F NC 5220 00 ..

Overall dimensions mm 577x114 h

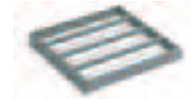

**ORD. NO.
TOOL HOLDERS**

**TOOL HOLDER
TYPE**

**MAX. QUANTITY PER TOOL
FRAME F NC 5020 00 ..**

**MAX. QUANTITY PER TOOL
FRAME F NC 5120 00 ..**

**MAX. QUANTITY PER TOOL
FRAME F NC 5220 00 ..**

ORD. NO. TOOL HOLDERS	TOOL HOLDER TYPE	MAX. QUANTITY PER TOOL FRAME F NC 5020 00 ..	MAX. QUANTITY PER TOOL FRAME F NC 5120 00 ..	MAX. QUANTITY PER TOOL FRAME F NC 5220 00 ..
F NC 9510 00 03	ISO 30	7	24	32
F NC 9530 00 03	ISO 40	7	24	32
F NC 9540 00 03	ISO 45	5	18	24
F NC 9550 00 03	ISO 50	5	15	20
F NC 9560 00 03	VDI 30	7	24	32
F NC 9570 00 03	VDI 40	5	18	24
F NC 9580 00 03	VDI 50	5	18	24
F NC 9590 00 03	VDI 60	5	15	20
F NC 9720 00 03	MORSE TAPER 2	7	24	32
F NC 9730 00 03	MORSE TAPER 3	7	24	32
F NC 9740 00 03	MORSE TAPER 4	7	24	32
F NC 9750 00 03	MORSE TAPER 5	5	18	24
F NC 9270 00 03	CAPTO C3	7	24	32
F NC 9275 00 03	CAPTO C4	5	18	24
F NC 9280 00 03	CAPTO C5	5	18	24
F NC 9285 00 03	CAPTO C6	5	18	24
F NC 9290 00 03	CAPTO C8	4	12	16
F NC 9210 00 03	HSK A32-B40	7	24	32
F NC 9220 00 03	HSK A40-B50	7	24	32
F NC 9230 00 03	HSK A50-B63	5	18	24
F NC 9240 00 03	HSK A63-B80	5	18	24
F NC 9250 00 03	HSK A80-B100	4	12	16
F NC 9260 00 03	HSK A100-B125	4	12	16
F NC 9640 00 03	2"	5	18	24
F NC 9650 00 03	2" 1/4	5	15	20
F NC 9010 00 03	58 mm	9	27	36
F NC 9020 00 03	65 mm	8	24	32
F NC 9030 00 03	75 mm	7	21	28
F NC 9040 00 03	87 mm	6	18	24
F NC 9050 00 03	105 mm	5	15	20

KEY



All indicated loads are net and refer to evenly distributed weights.

RAL 7000 F.01 RAL 6011 F.02

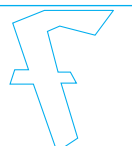

TROLLEY SERIES NC-COMBI

TOOL HOLDER FRAME FOR WOODEN INSERT OF MULTIPLEX FOR TROLLEYS F CN 0100 (NC102) / F CN 0600 (NC104)

- 01
- 02



TOOL FOR WOODEN INSERT OF MULTIPLEX

ORD. NO.

F NC 5021 00 01

Horizontal frame load capacity: 50 kg

Overall dimensions mm 584x140x146 h



WOODEN INSERT OF MULTIPLEX

ORD. NO.

F NC 2510 00 00

Overall dimensions mm 525x138x50 h



ALUMINIUM INSERT FOR TROLLEYS
F CN 0100 (NC102) / F CN 0600 (NC104)

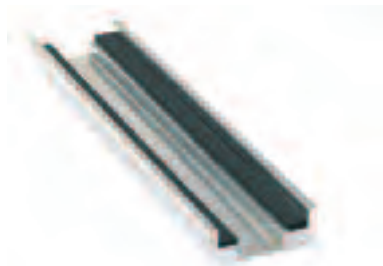

ORD. NO.

F NC 2410 00 00

Aluminium insert with rubber

Overall dim. mm 525x135x45 h



DRAWING POCKET FOR TROLLEYS
F CN 0100 (NC102) / F CN 0600 (NC104)

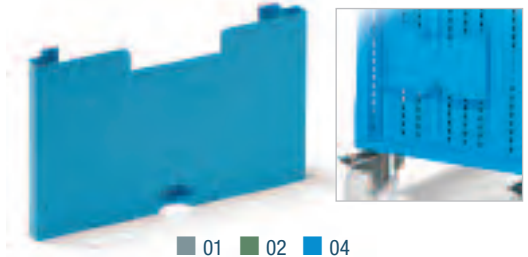

- 01
- 02
- 04

ORD. NO.

F CN 5560 00 04

Drawing pocket for size DIN A4

Overall dimensions mm 312x35x190 h

TOOLING SHELF FOR TROLLEYS
F CN 0100 (NC102) / F CN 0600 (NC104)

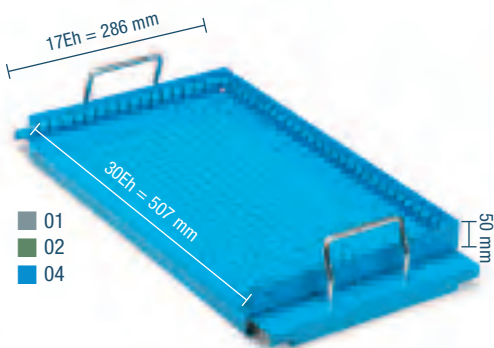

- 01
- 02
- 04

ORD. NO.

F CN 5320 00 04

Tooling shelf

Overall dimensions mm 598x303x59 h

DRAWERS 31,5x27 EH FULL TELESCOPIC EXTENSION FOR TROLLEYS
F CN 0600 (NC104)

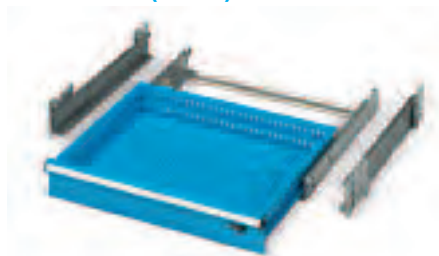

- 01
- 02
- 04
- 08

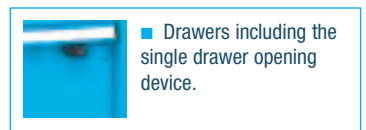

- It is not possible to insert tool holder frames in these drawers.

- Partitioning material: see page B47

ORD. NO.

FRONT HEIGHT mm

LOAD CAPACITY kg

USABLE DIM. mm

F NC 8607 00 04

75

30

523x447x54 h

F NC 8610 00 04

100

30

523x447x79 h

F NC 8615 00 04

150

30

523x447x129 h

Extension 100%

- RAL 7000 F.01
- RAL 6011 F.02
- RAL 5012 F.04
- RAL 7035 F.08

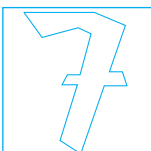

- All indicated loads are net and refer to evenly distributed weights.

KEY ■

- Partitioning material: see page A180

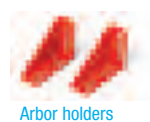

TRAVERSE GUARDS FOR TROLLEYS F CN 0600 (NC104)

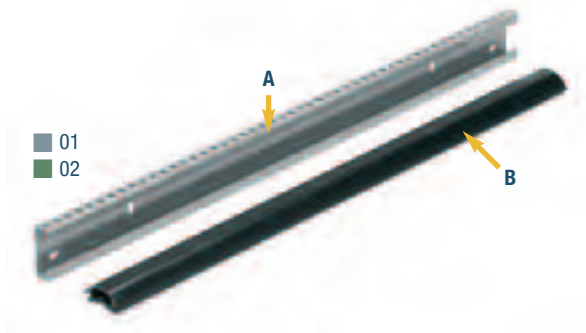

A ORD. NO. F CN 3010 00 01 ■ RAL 7000

A ORD. NO. F CN 3010 00 02 ■ RAL 6011

Perforated traverse guards

Overall dimensions mm: 623x28x50 h

B ORD. NO. F CN 3030 00 07

Neoprene cover



FIXING BRACKET

ORD. NO.	FOR TOOLS Ø MAX. mm	REQUIRED Q.TY OF FIXING BRACKETS	QUANTITY UNITS
F CN 3105 00 99	15	16	2
F CN 3110 00 99	27	12	3
F CN 3115 00 99	35	9	4
F CN 3120 00 99	48	8	5
F CN 3125 00 99	60	6	6
F CN 3130 00 99	73	6	7
F CN 3135 00 99	85	5	8
F CN 3140 00 99	98	4	9
F CN 3145 00 99	110	4	10
F CN 3150 00 99	123	4	11
F CN 3155 00 99	135	3	12

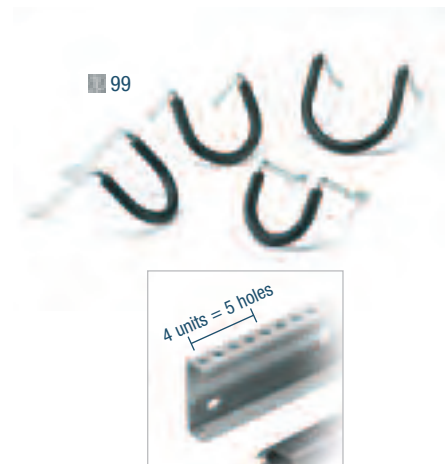

TOOL HANGING FRAMES FOR TROLLEYS F CN 0600 (NC104)

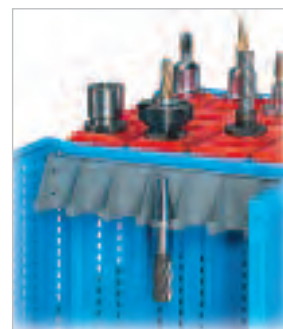

ORD. NO.	FOR TOOLS	Ø MAX. mm	MAX. Q.TY OF TOOLS	WIDTH mm	DEPTH mm
F CN 3210 00 01	ISO 40	63/50	9	597	56
F CN 3220 00 01	ISO 45	82/63	7	597	75
F CN 3230 00 01	ISO 50	98/80	5	597	84
F CN 3240 00 01	ISO 50	112/80	5	597	100
F CN 3260 00 01	ISO 55	130/89	4	597	120
F CN 3270 00 01	ISO 60	160/109	3	597	140

■ INFO

■ RAL 7000 F.01 ■ RAL 6011 F.02 ■ RAL 5012 F.04 ■ RAL 7035 F.08



www.famispa.com

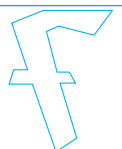

WHEELS SERIES NC-COMBI

STANDARD RUBBER



SWIVEL WHEEL WITH BRAKE

ORD. NO.	Ø mm	C mm	LOAD CAPACITY kg
C RG DAC11 100	100	130	75
C RG DAC12 125	125	160	100
C RG DAC13 150	150	185	115



FIXED WHEEL

ORD. NO.	Ø mm	C mm	LOAD CAPACITY kg
C RG BAC11 100	100	130	75
C RG BAC12 125	125	160	100
C RG BAC13 150	150	185	115

NYLON



SWIVEL WHEEL WITH BRAKE

ORD. NO.	Ø mm	C mm	LOAD CAPACITY kg
C RN DAD10 100	100	130	125
C RN DAD11 125	125	160	180



FIXED WHEEL

ORD. NO.	Ø mm	C mm	LOAD CAPACITY kg
C RN BAD10 100	100	130	125
C RN BAD11 125	125	160	180

NO-SMEAR RUBBER



SWIVEL WHEEL WITH BRAKE

ORD. NO.	Ø mm	C mm	LOAD CAPACITY kg
C RG DPH22 125	125	160	100



FIXED WHEEL

ORD. NO.	Ø mm	C mm	LOAD CAPACITY kg
C RG BPH22 125	125	160	100

ELASTIC RUBBER



SWIVEL WHEEL WITH BRAKE

ORD. NO.	Ø mm	C mm	LOAD CAPACITY kg
C RG DCE15 125	125	160	180



FIXED WHEEL

ORD. NO.	Ø mm	C mm	LOAD CAPACITY kg
C RG BCE15 125	125	160	180

POLYURETHANE



SWIVEL WHEEL WITH BRAKE

ORD. NO.	Ø mm	C mm	LOAD CAPACITY kg
C RN DDD31 125	125	160	180



FIXED WHEEL

ORD. NO.	Ø mm	C mm	LOAD CAPACITY kg
C RN BDD31 125	125	160	180

KEY

- Follow the formula to calculate the load capacity of the trolley:
 $(A \times 3) - 40 \text{ kg}$
 A = load capacity of the wheel
 40 kg = average weight of the trolley



WHEELS

WHEELS SERIES NC-COMBI

STANDARD RUBBER



SWIVEL WHEEL WITH BRAKE

ORD. NO.	Ø mm	C mm	LOAD CAPACITY kg
C RG DAC15 200	200	242	205

FIXED WHEEL

ORD. NO.	Ø mm	C mm	LOAD CAPACITY kg
C RG BAC15 200	200	242	205

NYLON



SWIVEL WHEEL WITH BRAKE

ORD. NO.	Ø mm	C mm	LOAD CAPACITY kg
C RN DAD04 160	160	204	300

FIXED WHEEL

ORD. NO.	Ø mm	C mm	LOAD CAPACITY kg
C RN BAD04 160	160	204	300

NO-SMEAR RUBBER



SWIVEL WHEEL WITH BRAKE

ORD. NO.	Ø mm	C mm	LOAD CAPACITY kg
C RG DPH25 160	160	204	200

FIXED WHEEL

ORD. NO.	Ø mm	C mm	LOAD CAPACITY kg
C RG BPH25 160	160	204	200

ELASTIC RUBBER



SWIVEL WHEEL WITH BRAKE

ORD. NO.	Ø mm	C mm	LOAD CAPACITY kg
C RG DCE15 160	160	204	300

FIXED WHEEL

ORD. NO.	Ø mm	C mm	LOAD CAPACITY kg
C RG BCE15 160	160	204	300

POLYURETHANE



SWIVEL WHEEL WITH BRAKE

ORD. NO.	Ø mm	C mm	LOAD CAPACITY kg
C RN DDD44 160	160	204	300

FIXED WHEEL

ORD. NO.	Ø mm	C mm	LOAD CAPACITY kg
C RN BDD44 160	160	204	300

KEY



Follow the formula to calculate the load capacity of the trolley:
 $(A \times 3) - 60 \text{ kg}$
 A = load capacity of the wheel
 60 kg = average weight of the trolley

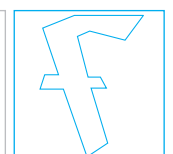
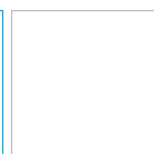
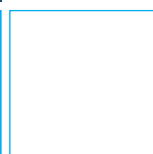

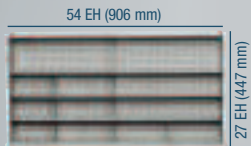

ORD. NO. F AA 1400 19 08
RAL 7035



ORD. NO. F AA 1800 08 08
RAL 7035

■ The max. height of the tool holder taper which can be inserted in the drawer frame is **143 mm**. For higher tapers, please see page **B28**.

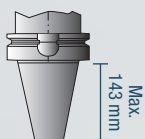

■ Frames ORD. NO. **F NC 5160 00 04** are height-adjustable and can be assembled horizontally or angled.

FLOOR FIXING SET



2x

- 2 "HILTI" plugs for concrete floors ≥ to classes B25/RBK250/MP_A 25 N/mm²
- Recommended traction of the plug: 2.9 KN
- Plug diameter: Ø 6 mm

ORD. NO. F AG 9204 00 99

CABINET WITH LEAF DOORS

ORD. NO. _____ **DRAWERS** _____

F AA 1400 19 08 **2**

- Including 2 drawers (100 kg)
- 2 tool holder frames for drawers
- 1 height adjustable tool holder frame
- 2 height adjustable galvanised shelves (100 kg)

Dimensions mm 1023x555x2000 h

Tools and tool holders excluded

ROLLER SHUTTER CABINET

ORD. NO. _____

F AA 1800 08 08

- Including 4 height adjustable tool holder frames

Dimensions mm 1023x555x2200 h

Tools and tool holders excluded

RAL 7000 F.01

RAL 6011 F.02

RAL 5012 F.04

RAL 7035 F.08

SUPPLEMENTARY PARTS ■

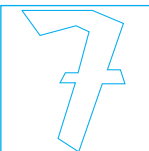

- **Spare key.** Always indicate the number on the cylinder lock of the key to be replaced.
ORD. NO. R CSC 0002 00
- **Master key.** This type of key opens all the 45 and 46 series locks.
ORD. NO. R CSC 0001 00



LENGTH = 1023 mm DEPTH = 555 mm (54x27 Eh)

CABINETS SERIES NC-PERFORM

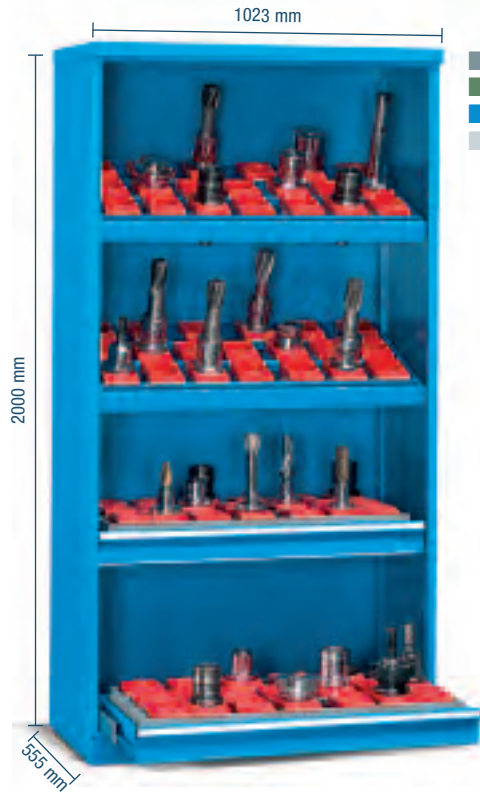

ORD. NO.

F AA 1401 01 04

Including: 2 frames 3-rows with carriers ORD. NO. **F NC 5160 00 04**
2 frames 3-rows ORD. NO. **F NC 5140 00 01**
2 pair of carriers ORD. NO. **F NC 5630 00 01**
2 telescopic extension drawers ORD. NO. **F AC 1250 00 04**

Dimensions mm 1023x555x2000 h Tool holders excluded

ORD. NO.

F AA 1401 02 04

Including: 4 frames 3-rows with carriers ORD. NO. **F NC 5160 00 04**
Dimensions mm 1023x555x2000 h
Tool holders excluded



ORD. NO.
TOOL HOLDERS

ORD. NO. TOOL HOLDERS	TOOL HOLDER TYPE	MAX. QUANTITY PER TOOL FRAME F NC 5160 00 ..	MAX. QUANTITY PER TOOL FRAME F NC 5140 00 ..
F NC 9510 00 03	ISO 30	36	33
F NC 9530 00 03	ISO 40	36	33
F NC 9540 00 03	ISO 45	30	27
F NC 9550 00 03	ISO 50	24	24
F NC 9560 00 03	VDI 30	36	33
F NC 9570 00 03	VDI 40	30	27
F NC 9580 00 03	VDI 50	30	27
F NC 9590 00 03	VDI 60	24	24
F NC 9720 00 03	MORSE TAPER 2	36	33
F NC 9730 00 03	MORSE TAPER 3	36	33
F NC 9740 00 03	MORSE TAPER 4	36	33
F NC 9750 00 03	MORSE TAPER 5	30	27
F NC 9270 00 03	CAPTO C3	36	33
F NC 9275 00 03	CAPTO C4	30	27
F NC 9280 00 03	CAPTO C5	30	27

ORD. NO.
TOOL HOLDERS

ORD. NO. TOOL HOLDERS	TIPO TOOL HOLDER	MAX. QUANTITY PER TOOL FRAME F NC 5160 00 ..	MAX. QUANTITY PER TOOL FRAME F NC 5140 00 ..
F NC 9285 00 03	CAPTO C6	30	27
F NC 9290 00 03	CAPTO C8	24	21
F NC 9210 00 03	HSK A32-B40	36	33
F NC 9220 00 03	HSK A40-B50	36	33
F NC 9230 00 03	HSK A50-B63	30	27
F NC 9240 00 03	HSK A63-B80	30	27
F NC 9250 00 03	HSK A80-B100	24	21
F NC 9260 00 03	HSK A100-B125	24	21
F NC 9640 00 03	2"	30	27
F NC 9650 00 03	2" 1/4	24	24
F NC 9010 00 03	58 mm	45	42
F NC 9020 00 03	65 mm	42	39
F NC 9030 00 03	75 mm	36	33
F NC 9040 00 03	87 mm	30	27
F NC 9050 00 03	105 mm	24	24

KEY

RAL 7000 F.01 RAL 6011 F.02 RAL 5012 F.04 RAL 7035 F.08



- Cabinet load capacity: **800 kg**
- Frame load capacity: **150 kg**
- Drawers load capacity: **100 kg**
- All indicated loads are net and refer to evenly distributed weights.

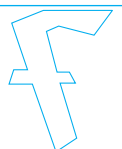

CABINETS SERIES NC-PERFOM

**ORD. NO.****F AA 1400 17 04**

Including: 2 frames 3-rows with carriers ORD. NO. **F NC 5160 00 04**, 2 frames 3-rows ORD. NO. **F NC 5140 00 01**, 2 pair of carriers ORD. NO. **F NC 5630 00 01**
2 telescopic extension drawers ORD. NO. **F AC 1250 00 04**

Dimensions mm 1023x555x2000 h

Tool holders excluded

**ORD. NO.****F AA 1400 18 04**

Including: 4 frames 3-rows with carriers ORD. NO. **F NC 5160 00 04**

Dimensions mm 1023x555x2000 h

Tool holders excluded

**ORD. NO.****F AA 1402 07 04**

Including: 2 frames 3-rows with carriers ORD. NO. **F NC 5160 00 04**, 2 frames 3-rows ORD. NO. **F NC 5140 00 01**, 2 pair of carriers ORD. NO. **F NC 5630 00 01**
2 telescopic extension drawers ORD. NO. **F AC 1250 00 04**

Dimensions mm 1023x555x2000 h

Tool holders excluded

■ 3 mm thickness polycarbonate doors

**ORD. NO.****F AA 1402 08 04**

Including: 4 frames 3-rows with carriers ORD. NO. **F NC 5160 00 04**

Dimensions mm 1023x555x2000 h

Tool holders excluded

LENGTH = 1023 mm DEPTH = 555 mm (54x27 Eh)

CABINETS SERIES NC-PERFORM



■ RAL 7035

CABINET WITH LEAF DOORS

ORD. NO.	DRAWERS
F AA 1400 19 08	2
Including 2 drawers (100 kg)	
2 tool holder frames for drawers	
1 height adjustable tool holder frame	
2 height adjustable galvanised shelves (100 kg)	
Dimensions mm 1023x555x2000 h	
Tools, tool holders and toolboxes excluded	



■ RAL 7035

ROLLER SHUTTER CABINET

ORD. NO.

F AA 1800 09 08

Including 2 height adjustable tool holder frames

2 height adjustable galvanised shelves (100 kg)

Dimensions mm 1023x555x2200 h

Tools, tool holders and toolboxes excluded



- Cabinet load capacity: **800 kg**
- Frame load capacity: **150 kg**
- Drawers load capacity: **100 kg**
- All indicated loads are net and refer to evenly distributed weights

■ KEY

RAL 7000 F.01

RAL 6011 F.02

RAL 5012 F.04

RAL 7035 F.08



■ Detail of roller shutter door

■ Partitioning material see page B29

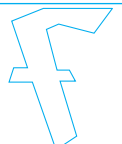

CABINETS SERIES NC-PERFOM



SLIDING DOORS CABINET

ORD. NO.

F AB 8302 05 04

Including:

- 4 frames 3-rows with carriers ORD. NO. **F NC 5160 00 04**
- 4 frames 3-rows ORD. NO. **F NC 5140 00 01**
- 4 pair of carriers ORD. NO. **F NC 5630 00 01**
- 4 telescopic extension drawers ORD. NO. **F AC 1250 00 04**

Dimensions mm 2046x600x2000 h

Tool holders excluded

- 4 mm thickness polycarbonate doors



SLIDING DOORS CABINET

ORD. NO.

F AB 8300 12 04

Including:

- 4 frames 3-rows with carriers ORD. NO. **F NC 5160 00 04**
- 4 frames 3-rows ORD. NO. **F NC 5140 00 01**
- 4 pair of carriers ORD. NO. **F NC 5630 00 01**
- 4 telescopic extension drawers ORD. NO. **F AC 1250 00 04**

Dimensions mm 2046x600x2000 h

Tool holders excluded

RAL 7000 F.01

RAL 6011 F.02

RAL 5012 F.04

RAL 7035 F.08

KEY ■



■ Partitioning material see page B29

- Cabinet load capacity: **800 kg** per compartment
- Frame load capacity: **150 kg**
- Drawers load capacity: **100 kg**
- All indicated loads are net and refer to evenly distributed weights



LENGTH = 1023 mm DEPTH = 555 mm (54x27 Eh)

CABINETS SERIES NC-PERFORM

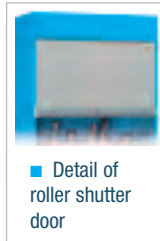
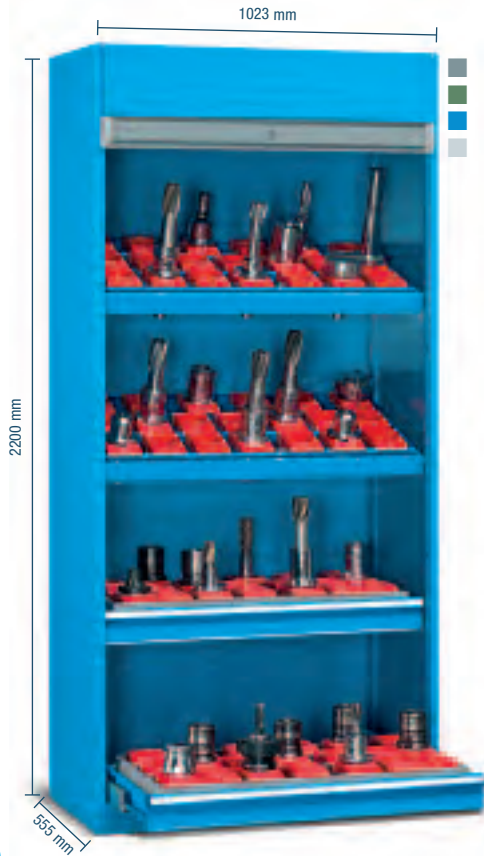

■ Detail of roller shutter door



ORD. NO.

F AA 1800 07 04

Including: 2 frames 3-rows with carriers ORD. NO. **F NC 5160 00 04**, 2 frames 3-rows ORD. NO. **F NC 5140 00 01**, 2 pair of carriers ORD. NO. **F NC 5630 00 01**
2 telescopic extension drawers ORD. NO. **F AC 1250 00 04**

Dimensions mm 1023x555x2200 h

Tool holders excluded

ORD. NO.

F AA 1800 08 04

Including: 4 frames 3-rows with carriers ORD. NO. **F NC 5160 00 04**

Dimensions mm 1023x555x2200 h

Tool holders excluded



ORD. NO.
TOOL HOLDERS

TOOL HOLDER TYPE	MAX. QUANTITY PER TOOL FRAME F NC 5160 00 ..	MAX. QUANTITY PER TOOL FRAME F NC 5140 00 ..
------------------	--	--

F NC 9510 00 03	ISO 30	36	33
F NC 9530 00 03	ISO 40	36	33
F NC 9540 00 03	ISO 45	30	27
F NC 9550 00 03	ISO 50	24	24
F NC 9560 00 03	VDI 30	36	33
F NC 9570 00 03	VDI 40	30	27
F NC 9580 00 03	VDI 50	30	27
F NC 9590 00 03	VDI 60	24	24
F NC 9720 00 03	MORSE TAPER 2	36	33
F NC 9730 00 03	MORSE TAPER 3	36	33
F NC 9740 00 03	MORSE TAPER 4	36	33
F NC 9750 00 03	MORSE TAPER 5	30	27
F NC 9270 00 03	CAPTO C3	36	33
F NC 9275 00 03	CAPTO C4	30	27
F NC 9280 00 03	CAPTO C5	30	27



ORD. NO.
TOOL HOLDERS

TOOL HOLDER TYPE	MAX. QUANTITY PER TOOL FRAME F NC 5160 00 ..	MAX. QUANTITY PER TOOL FRAME F NC 5140 00 ..
------------------	--	--

F NC 9285 00 03	CAPTO C6	30	27
F NC 9290 00 03	CAPTO C8	24	21
F NC 9210 00 03	HSK A32-B40	36	33
F NC 9220 00 03	HSK A40-B50	36	33
F NC 9230 00 03	HSK A50-B63	30	27
F NC 9240 00 03	HSK A63-B80	30	27
F NC 9250 00 03	HSK A80-B100	24	21
F NC 9260 00 03	HSK A100-B125	24	21
F NC 9640 00 03	2"	30	27
F NC 9650 00 03	2" 1/4	24	24
F NC 9010 00 03	58 mm	45	42
F NC 9020 00 03	65 mm	42	39
F NC 9030 00 03	75 mm	36	33
F NC 9040 00 03	87 mm	30	27
F NC 9050 00 03	105 mm	24	24

■ KEY

RAL 7000 F.01 RAL 6011 F.02 RAL 5012 F.04 RAL 7035 F.08



- Cabinet load capacity: **800 kg**
- Frame load capacity: **150 kg**
- Drawers load capacity: **100 kg**
- All indicated loads are net and refer to evenly distributed weights



■ Detail of roller shutter door

■ Partitioning material see page **B29**

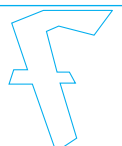

CABINETS SERIES NC-PERFOM

EMPTY CABINET WITH DOORS

■ 01
■ 02
■ 04
■ 08



ORD. NO.

F AA 1400 00 04

Cabinet load capacity: 800 kg

Dimensions mm 1023x555x2000 h

Internal dimensions mm 995x500x1850 h

The cabinet series F AA 1400 is standard supplied with 2 floor fixing brackets and 2 wall fixing brackets.

EMPTY CABINET WITH DOORS WITH PERFORATED PANELS

■ 01
■ 02
■ 04
■ 08



ORD. NO.

F AA 1403 00 04

Cabinet load capacity: 800 kg

Load capacity of each individual door: 40 kg

Dimensions mm 1023x555x2000 h

Internal dimensions mm 995x500x1850 h

The cabinet series F AA 1403 is standard supplied with 2 floor fixing brackets and 2 wall fixing brackets.

EMPTY CABINET WITH PAIR OF 3 mm THICKNESS POLYCARBONATE DOORS

■ 01
■ 02
■ 04
■ 08



ORD. NO.

F AA 1402 00 04

Cabinet load capacity: 800 kg

Dimensions mm 1023x555x2000 h

Internal dimensions mm 995x500x1850 h

The cabinet series F AA 1402 is standard supplied with 2 floor fixing brackets and 2 wall fixing brackets.

EMPTY CABINET WITHOUT DOOR

■ 01
■ 02
■ 04
■ 08



ORD. NO.

F AA 1401 00 04

Cabinet load capacity: 800 kg

Dimensions mm 1023x555x2000 h

Internal dimensions mm 995x500x1850 h

The cabinet series F AA 1401 is standard supplied with 2 floor fixing brackets and 2 wall fixing brackets.

EMPTY CABINET WITH ROLLER SHUTTER DOOR

■ 01
■ 02
■ 04
■ 08



ORD. NO.

F AA 1800 00 04

Cabinet load capacity: 800 kg

Dimensions mm 1023x555x2200 h

Internal dimensions mm 995x500x1820 h

The cabinet series F AA 1800 is standard supplied with 2 floor fixing brackets and 2 wall fixing brackets.

EMPTY CABINET WITH POLYCARB. DOORS 4 mm THICKNESS AND CENTRE SUPPORT

■ 01
■ 02
■ 04
■ 08



ORD. NO.

F AB 8302 00 04

Cabinet load capacity: 800 kg per compartment

Dimensions mm 2046x600x2000 h

Internal dim. of each compart. mm 995x500x1850 h

The cabinet series F AB 8302 is standard supplied with 4 floor fixing brackets and 4 wall fixing brackets.

- The cabinet must be secured to the floor or wall. If one or more drawers are fitted, the cabinets must be secured to the floor or to the wall (if the drawers are fitted at a height over 1000 mm from the floor, the cabinet must be secured to the wall only). The cabinet with doors with perforated panels must be fixed to the wall.

■ 01
■ 02
■ 04
■ 08



EMPTY CABINET WITH DOORS AND CENTRE SUPPORT

ORD. NO.

F AB 8300 00 04

Cabinet load capacity: 800 kg per compartment

Dimensions mm 2046x600x2000 h

Internal dim. of each compart. mm 995x500x1850 h

The cabinet series F AB 8300 is standard supplied with 4 floor fixing brackets and 4 wall fixing brackets.



- Each drawer introduced into the cabinet compartments has a maximum load capacity of 350 kg regardless of the load capacity of the cabinet

LENGTH = 1023/2046 mm DEPTH = 555/600 mm (54x27 Eh)

CABINETS SERIES NC-PERFORM

PAIR OF NORMAL OR TELESCOPIC EXTENSION DRAWERS 24x27 EH

ORD. NO.	EXTENSION
F AC 1600 00 04	NORMAL
F AC 1650 00 04	TELESCOPIC

Load capacity of each normal extension drawer: 50 kg

Load capacity of each telescopic extension drawer: 60 kg

Internal dimensions mm 396x447x85 h (for drawer)

■ 01
■ 02
■ 04

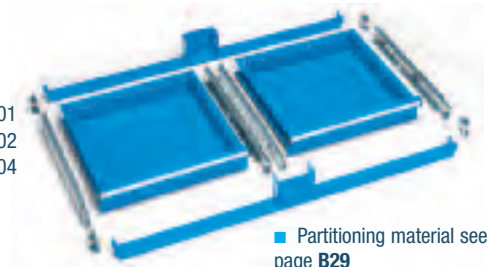

■ Partitioning material see page B29

NORMAL OR TELESCOPIC EXTENSION DRAWERS 54x27 EH

ORD. NO.	EXTENSION
F AC 1200 00 04	NORMAL
F AC 1250 00 04	TELESCOPIC

Load capacity of normal extension drawer: 50 kg

Load capacity of telescopic extension drawer: 100 kg

Internal dimensions mm 906x447x85 h

■ 01
■ 02
■ 04



■ Partitioning material see page B29

FULL EXTENSION SUSPENSION FOLDER FRAME FOR SUSPENSION FOLDER DIN A4

ORD. NO.
F AC 7500 00 07

The suspension folder frames are supplied with full extension guide rails (100% extraction) with 30 kg load capacity

Overall dimensions: 990x500 mm

For suspension folder DIN A4

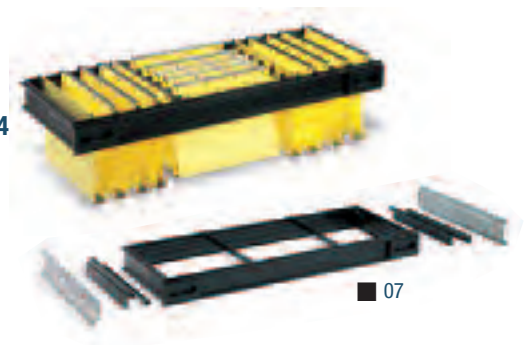

■ 07

ADJUSTABLE SHELF DEPTH 500 mm

ORD. NO.	DIM. mm	Q.TY STRENG. BAR	LOAD CAPACITY kg
F AC 2500 01 99	995x500x35 h	0	100
F AC 2500 03 99	995x500x35 h	1	180

Including 4 hooks

The depth of this shelf is suitable for the following containers:
size 4A2 / size 4 / size 4A5



■ 99



size 4A2



size 4



size 4A5



■ This type of shelf can be assembled only if the perforated back panel is not fitted.

■ Contenitori vedi pag. G28 – G30



CABINETS SERIES NC-PERFORM

TOOL HOLDER FRAMES 3-ROWS FOR DRAWERS



■ 01
■ 02

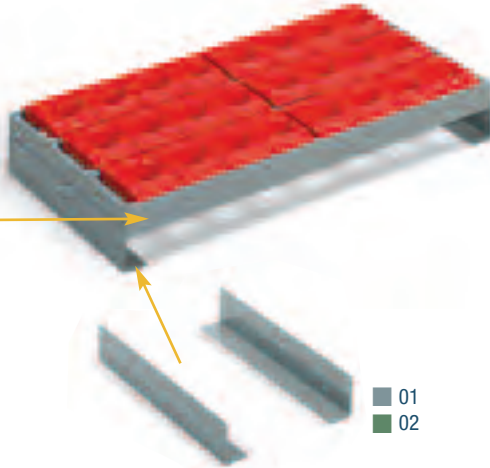

■ 01
■ 02

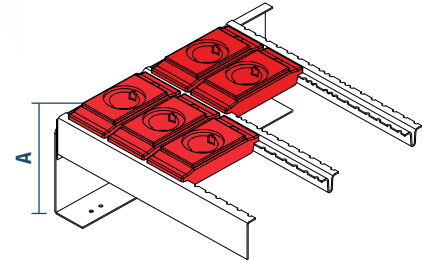
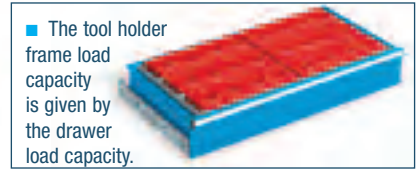

ORD. NO.

F NC 5140 00 01

Overall dim. mm 890x444x69 h

PAIR OF CARRIERS

ORD. NO.

DIMENSIONS mm

FOR LENGTH TAPERS mm REF. A

F NC 5630 00 01

446x86 h

A = 93 / 118 / 143

F NC 5830 00 01

446x136 h

A = 143 / 168 / 193

ORD. NO. TOOL HOLDERS

TOOL HOLDER TYPE

MAX. QUANTITY PER TOOL FRAME F NC 5140 00..

F NC 9510 00 03	ISO 30	33
F NC 9530 00 03	ISO 40	33
F NC 9540 00 03	ISO 45	27
F NC 9550 00 03	ISO 50	24
F NC 9560 00 03	VDI 30	33
F NC 9570 00 03	VDI 40	27
F NC 9580 00 03	VDI 50	27
F NC 9590 00 03	VDI 60	24
F NC 9720 00 03	MORSE TAPER 2	33
F NC 9730 00 03	MORSE TAPER 3	33

ORD. NO. TOOL HOLDERS

TOOL HOLDER TYPE

MAX. QUANTITY PER TOOL FRAME F NC 5140 00..

F NC 9740 00 03	MORSE TAPER 4	33
F NC 9750 00 03	MORSE TAPER 5	27
F NC 9270 00 03	CAPTO C3	33
F NC 9275 00 03	CAPTO C4	27
F NC 9280 00 03	CAPTO C5	27
F NC 9285 00 03	CAPTO C6	27
F NC 9290 00 03	CAPTO C8	21
F NC 9210 00 03	HSK A32-B40	33
F NC 9220 00 03	HSK A40-B50	33
F NC 9230 00 03	HSK A50-B63	27

ORD. NO. TOOL HOLDERS

TOOL HOLDER TYPE

MAX. QUANTITY PER TOOL FRAME F NC 5140 00..

F NC 9240 00 03	HSK A63-B80	27
F NC 9250 00 03	HSK A80-B100	21
F NC 9260 00 03	HSK A100-B125	21
F NC 9640 00 03	2"	27
F NC 9650 00 03	2" 1/4	24
F NC 9010 00 03	58 mm	42
F NC 9020 00 03	65 mm	39
F NC 9030 00 03	75 mm	33
F NC 9040 00 03	87 mm	27
F NC 9050 00 03	105 mm	24

TILTING TOOL HOLDER FRAMES WITH 3 ROWS FOR CABINET

■ 01 ■ 02 ■ 04

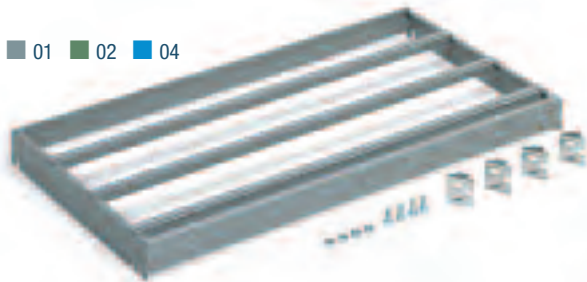

TOOL HOLDER FRAME 3-ROWS

ORD. NO.

F NC 5160 00 01

Horizontal frame load capacity: 150 kg

Overall dimensions mm 965x500x69



ORD. NO. TOOL HOLDERS

TOOL HOLDER TYPE

MAX. QUANTITY PER TOOL FRAME F NC 5160 00..

F NC 9510 00 03	ISO 30	36
F NC 9530 00 03	ISO 40	36
F NC 9540 00 03	ISO 45	30
F NC 9550 00 03	ISO 50	24
F NC 9560 00 03	VDI 30	36
F NC 9570 00 03	VDI 40	30
F NC 9580 00 03	VDI 50	30
F NC 9590 00 03	VDI 60	24
F NC 9720 00 03	MORSE TAPER 2	36
F NC 9730 00 03	MORSE TAPER 3	36

ORD. NO. TOOL HOLDERS

TOOL HOLDER TYPE

MAX. QUANTITY PER TOOL FRAME F NC 5160 00..

F NC 9740 00 03	MORSE TAPER 4	36
F NC 9750 00 03	MORSE TAPER 5	30
F NC 9270 00 03	CAPTO C3	36
F NC 9275 00 03	CAPTO C4	30
F NC 9280 00 03	CAPTO C5	30
F NC 9285 00 03	CAPTO C6	30
F NC 9290 00 03	CAPTO C8	24
F NC 9210 00 03	HSK A32-B40	36
F NC 9220 00 03	HSK A40-B50	36
F NC 9230 00 03	HSK A50-B63	30

ORD. NO. TOOL HOLDERS

TOOL HOLDER TYPE

MAX. QUANTITY PER TOOL FRAME F NC 5160 00..

F NC 9240 00 03	HSK A63-B80	30
F NC 9250 00 03	HSK A80-B100	24
F NC 9260 00 03	HSK A100-B125	24
F NC 9640 00 03	2"	30
F NC 9650 00 03	2" 1/4	24
F NC 9010 00 03	58 mm	45
F NC 9020 00 03	65 mm	42
F NC 9030 00 03	75 mm	36
F NC 9040 00 03	87 mm	30
F NC 9050 00 03	105 mm	24

24x27 EH / 54x27 EH

CABINETS SERIES NC-PERFORM

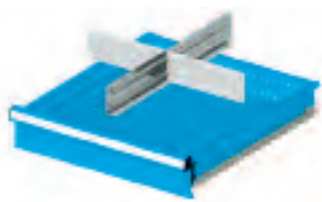

ORD. NO.	FOR FRONT HEIGHTS
F FH 0050 01 00	100
Set including:	
1 Slotted partition	455 mm
2 Plain partitions	200 mm

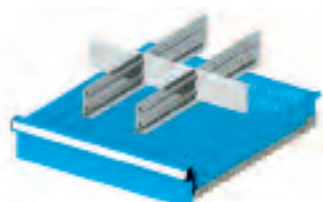

ORD. NO.	FOR FRONT HEIGHTS
F FH 0050 02 00	100
Set including:	
2 Slotted partitions	455 mm
3 Plain partitions	132 mm

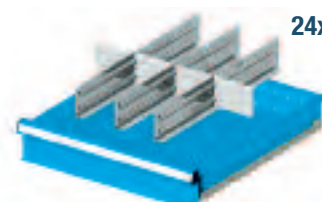

ORD. NO.	FOR FRONT HEIGHTS
F FH 0050 03 00	100
Set including:	
3 Slotted partitions	455 mm
4 Plain partitions	98 mm

24x27 EH

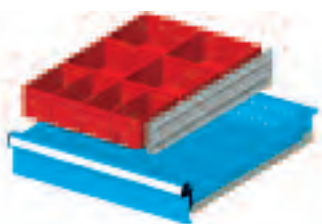

ORD. NO.	FOR FRONT HEIGHTS
F FH 0050 07 00	100
Set including:	
1 Slotted partition	455 mm
4 Plastic boxes	150x75 mm
4 Plastic boxes	150x150 mm

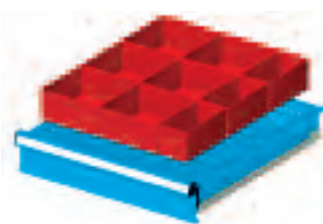

ORD. NO.	FOR FRONT HEIGHTS
F FH 0050 08 00	100
Set including:	
3 Plastic boxes	150x75 mm
6 Plastic boxes	150x150 mm

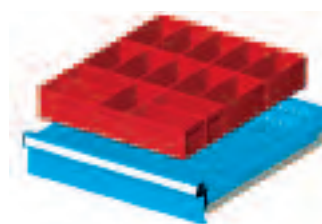

ORD. NO.	FOR FRONT HEIGHTS
F FH 0050 09 00	100
Set including:	
15 Plastic boxes	150x75 mm

■ Partitioning material see page A180

54x27 EH

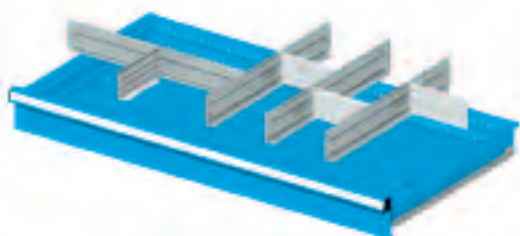

ORD. NO.	FOR FRONT HEIGHTS
F FH 0200 01 00	100
Set including:	
4 Slotted partitions	455 mm
4 Plain partitions	149 mm

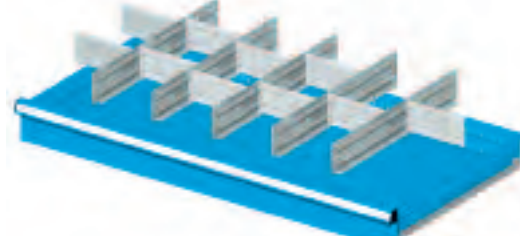

ORD. NO.	FOR FRONT HEIGHTS
F FH 0200 02 00	100
Set including:	
5 Slotted partitions	455 mm
10 Plain partitions	149 mm

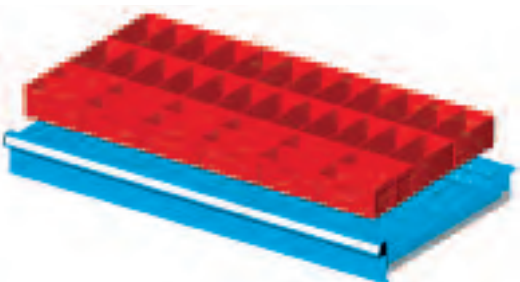

ORD. NO.	FOR FRONT HEIGHTS
F FH 0200 05 00	100
Set including:	
36 Plastic boxes	150x75 mm

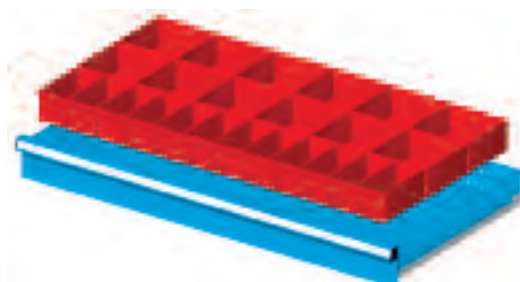

ORD. NO.	FOR FRONT HEIGHTS
F FH 0200 06 00	100
Set including:	
12 Plastic boxes	150x75 mm
12 Plastic boxes	150x150 mm



ORD. NO. F NC 0822 12 51
RAL 5012+7000



ORD. NO. F NC 0211 01 51
RAL 5012+7000

FIXING SET



■ Fixing material including (for 1 upright frame) 2 steel floor bolts M8x75 mm for uninterrupted concrete floors equal to higher than class: B25 / RBK250 / MPa 25 N for mm².

ORD. NO. F NC 8999 00 99

■ The shelving system must be fixed to the floor or to the wall.

SHELVING SYSTEM WITH ROLLER SHUTTER

ORD. NO.

F NC 0822 12 51

Including 4 telescopic extension drawers with tool holder frame 3-rows and carriers

Dimensions mm 1042x645x2200 h

Tools and tool holders excluded

SHELVING SYSTEM WITH LEAF DOORS

ORD. NO.

F NC 0211 01 51

Including 16 tool holder frames 1-row with angled carriers

Dimensions mm 1290x505x2000 h

Tools and tool holders excluded

RAL 7000 F.01

RAL 6011 F.02

RAL 5012 +
RAL 7000 F.51

RAL 7035 +
RAL 7000 F.56

SUPPLEMENTARY PARTS ■

■ **Spare key.** Always indicate the number on the cylinder lock of the key to be replaced.

ORD. NO. R CSC 0002 00

■ **Master key.** This type of key opens all the 45 and 46 series locks.

ORD. NO. R CSC 0001 00



SHELVING SYSTEM SERIES NC-SYSTEM

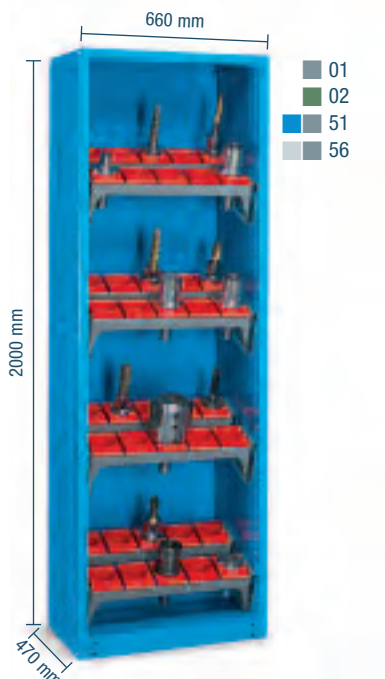

ORD. NO.

F NC 0110 01 51

Including: 8 frames 1-row ORD. NO. **F NC 5020 00 01**

8 pair of angled carriers ORD. NO. **F NC 5711 00 99**

Load capacity of shelving system: 1500 kg

Dimensions mm 660x470x2000 h

Tool holders excluded

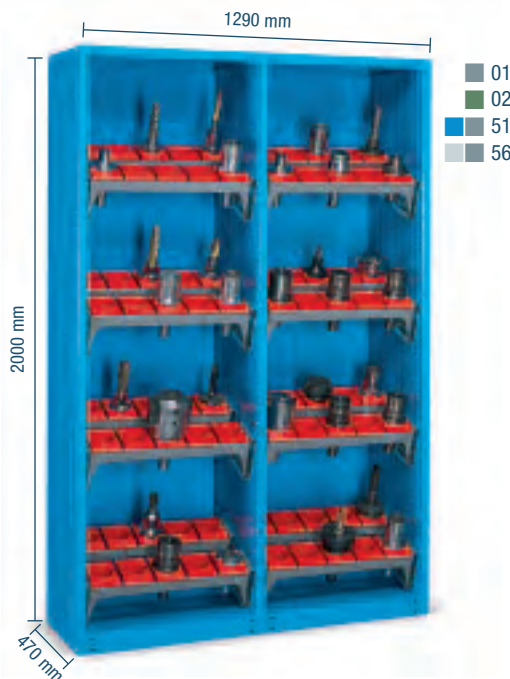

ORD. NO.

F NC 0210 01 51

Including: 16 frames 1-row ORD. NO. **F NC 5020 00 01**

16 pair of angled carriers ORD. NO. **F NC 5711 00 99**

Load capacity of shelving system for compartment: 500 kg

Dimensions mm 1290x470x2000 h

Tool holders excluded



ORD. NO.

F NC 0111 01 51

Including: 8 frames 1-row ORD. NO. **F NC 5020 00 01**

8 pair of angled carriers ORD. NO. **F NC 5711 00 99**

Load capacity of shelving system: 1500 kg

Dimensions mm 660x495x2000 h

Tool holders excluded



ORD. NO.

F NC 0211 01 51

Including: 16 frames 1-row ORD. NO. **F NC 5020 00 01**

16 pair of angled carriers ORD. NO. **F NC 5711 00 99**

Load capacity of shelving system for compartment: 500 kg

Dimensions mm 1290x495x2000 h

Tool holders excluded

KEY

RAL 7000 F.01 RAL 6011 F.02 RAL 5012 + RAL 7000 F.51 RAL 7035 + RAL 7000 F.56



- The shelving system must be fixed to the floor or to the wall
- All indicated loads are net and refer to evenly distributed weights

■ Tool holders see page B32



SHELVING SYSTEM SERIES NC-SYSTEM

**ORD. NO.
TOOL HOLDERS**TOOL HOLDER
TYPEMAX. QUANTITY PER
TOOL FRAME F NC 5020 00 ..

F NC 9510 00 03	ISO 30	7
F NC 9530 00 03	ISO 40	7
F NC 9540 00 03	ISO 45	5
F NC 9550 00 03	ISO 50	5
F NC 9560 00 03	VDI 30	7
F NC 9570 00 03	VDI 40	5
F NC 9580 00 03	VDI 50	5
F NC 9590 00 03	VDI 60	5
F NC 9720 00 03	MORSE TAPER 2	7
F NC 9730 00 03	MORSE TAPER 3	7
F NC 9740 00 03	MORSE TAPER 4	7
F NC 9750 00 03	MORSE TAPER 5	5
F NC 9270 00 03	CAPTO C3	7
F NC 9275 00 03	CAPTO C4	5
F NC 9280 00 03	CAPTO C5	5

**ORD. NO.
TOOL HOLDERS**TOOL HOLDER
TYPEMAX. QUANTITY PER
TOOL FRAME F NC 5020 00 ..

F NC 9285 00 03	CAPTO C6	5
F NC 9290 00 03	CAPTO C8	4
F NC 9210 00 03	HSK A32-B40	7
F NC 9220 00 03	HSK A40-B50	7
F NC 9230 00 03	HSK A50-B63	5
F NC 9240 00 03	HSK A63-B80	5
F NC 9250 00 03	HSK A80-B100	4
F NC 9260 00 03	HSK A100-B125	4
F NC 9640 00 03	2"	5
F NC 9650 00 03	2" 1/4	5
F NC 9010 00 03	58 mm	9
F NC 9020 00 03	65 mm	8
F NC 9030 00 03	75 mm	7
F NC 9040 00 03	87 mm	6
F NC 9050 00 03	105 mm	5



RAL 7000 F.01

RAL 6011 F.02

RAL 5012 F.04

RAL 7035 F.08

INFO ■

www.famispa.com

SHELVING SYSTEM SERIES NC-SYSTEM

EMPTY SHELVING SYSTEM SERIES F NC 0110 / F NC 0111

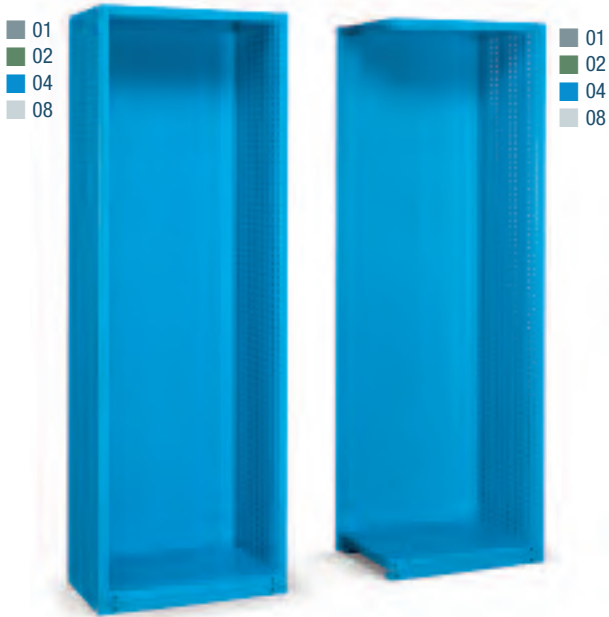

- 01
- 02
- 04
- 08

- 01
- 02
- 04
- 08



- 01
- 02
- 04
- 08

- 01
- 02
- 04
- 08

ORD. NO.
F NC 0110 00 04
Single shelving system
Load capacity of single shelving system: 1500 kg
Dim. mm 660x470x2000 h

ORD. NO.
F NC 0110 X0 04
Add-on shelving system
Load cap. of single shelving system + add-on: 500 kg for compartment
Dim. mm 630x470x2000 h

ORD. NO.
F NC 0111 00 04
Single shelving system
Load capacity of single shelving system: 1500 kg
Dim. mm 660x495x2000 h

ORD. NO.
F NC 0111 X0 04
Add-on shelving system
Load cap. of single shelving system + add-on: 500 kg for compartment
Dim. mm 630x495x2000 h

ADJUSTABLE SHELF



- 01
- 02
- 04

ORD. NO.
F NC 3200 01 04
LOAD CAPACITY kg: 30
Overall dimensions mm 600x470x30 h

RUBBER MAT



- 07

ORD. NO.
F NC 3950 00 07
Overall dimensions mm 595x465

ALUMINIUM INSERT FOR SHELVING SYSTEM F NC 0110 / F NC 0111



ORD. NO.
F NC 2410 00 00
Aluminium insert with rubber
Overall dimensions mm 525x135x45 h



Example of tool holder frame ORD. NO. F NC 5020 00 .. with aluminium support

KEY

- RAL 7000 F.01
- RAL 6011 F.02
- RAL 5012 F.04
- RAL 7035 F.08



- The shelving system must be fixed to the floor or to the wall
- All indicated loads are net and refer to evenly distributed weights

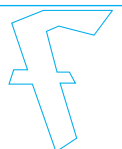

SHELVING SYSTEM SERIES NC-SYSTEM

TOOL FOR WOODEN INSERT OF MULTIPLEX FOR SHELVING SYSTEM F NC 0110 / F NC 0111

■ 01
■ 02



TOOL FOR WOODEN INSERT OF MULTIPLEX

ORD. NO.

F NC 5021 00 01

Horizontal frame load capacity: 50 kg

Overall dimensions mm 584x140x146 h



WOODEN INSERT OF MULTIPLEX

ORD. NO.

F NC 2510 00 00

Overall dimensions mm 525x138x50 h



Example of tool holder frame
ORD. NO. F NC 5021 00 ..

TOOL HOLDER FRAME AND ACCESSORIES FOR SHELVING SYSTEM F NC 0110 / F NC 0111

■ 01
■ 02

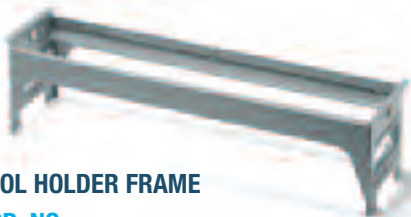

TOOL HOLDER FRAME

ORD. NO.

F NC 5020 00 01

Horizontal frame load capacity: 50 kg

Dimensions mm 584x140x146 h



■ 99

PAIR OF GALVANISED HANDLES

ORD. NO.

F NC 5005 00 99

For frame ORD. NO. F NC 5020 00 ..



■ 99



PAIR OF GALVANISED HORIZONTAL CARRIERS

ORD. NO.

F NC 5710 00 99

For frame ORD. NO. F NC 5020 00 ..

Overall dimensions mm 140x150 h



■ 99



PAIR OF GALVANISED ANGLED CARRIERS

ORD. NO.

F NC 5711 00 99

For frame ORD. NO. F NC 5020 00 ..

Overall dimensions mm 140x150 h

TOOL HOLDER FRAME 3-ROWS AND ACCESSORIES FOR SHELVING SYSTEM F NC 0110 / F NC 0111

■ 01
■ 02



TOOL HOLDER FRAME 3-ROWS

ORD. NO.

F NC 5120 00 01

Horizontal frame load capacity: 150 kg

Overall dimensions mm 584x444x69 h

■ 01
■ 02



HORIZONTAL PAIR OF CARRIERS

ORD. NO.

F NC 5620 00 01

For frame ORD. NO. F NC 5120 00 ..

Overall dimensions mm 430x112 h

■ 01
■ 02



ANGLED PAIR OF CARRIERS

ORD. NO.

F NC 5721 00 01

For frame ORD. NO. F NC 5120 00 ..

Overall dimensions mm 430x114 h

RAL 7000 F.01 RAL 6011 F.02

KEY ■

■ All indicated loads are net and refer to evenly distributed weights

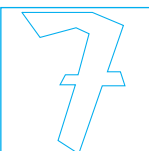

SHELVING SYSTEM SERIES NC-SYSTEM



ORD. NO.
TOOL HOLDERS

TOOL HOLDER TYPE	MAX. QUANTITY PER TOOL FRAME F NC 5020 00 ..	MAX. QUANTITY PER TOOL FRAME F NC 5120 00 ..
------------------	--	--

F NC 9510 00 03	ISO 30	7	24
F NC 9530 00 03	ISO 40	7	24
F NC 9540 00 03	ISO 45	5	18
F NC 9550 00 03	ISO 50	5	15
F NC 9560 00 03	VDI 30	7	24
F NC 9570 00 03	VDI 40	5	18
F NC 9580 00 03	VDI 50	5	18
F NC 9590 00 03	VDI 60	5	15
F NC 9720 00 03	MORSE TAPER 2	7	24
F NC 9730 00 03	MORSE TAPER 3	7	24
F NC 9740 00 03	MORSE TAPER 4	7	24
F NC 9750 00 03	MORSE TAPER 5	5	18
F NC 9270 00 03	CAPTO C3	7	24
F NC 9275 00 03	CAPTO C4	5	18
F NC 9280 00 03	CAPTO C5	5	18



ORD. NO.
TOOL HOLDERS

TOOL HOLDER TYPE	MAX. QUANTITY PER TOOL FRAME F NC 5020 00 ..	MAX. QUANTITY PER TOOL FRAME F NC 5120 00 ..
------------------	--	--

F NC 9285 00 03	CAPTO C6	5	18
F NC 9290 00 03	CAPTO C8	4	12
F NC 9210 00 03	HSK A32-B40	7	24
F NC 9220 00 03	HSK A40-B50	7	24
F NC 9230 00 03	HSK A50-B63	5	18
F NC 9240 00 03	HSK A63-B80	5	18
F NC 9250 00 03	HSK A80-B100	4	12
F NC 9260 00 03	HSK A100-B125	4	12
F NC 9640 00 03	2"	5	18
F NC 9650 00 03	2" 1/4	5	15
F NC 9010 00 03	58 mm	9	27
F NC 9020 00 03	65 mm	8	24
F NC 9030 00 03	75 mm	7	21
F NC 9040 00 03	87 mm	6	18
F NC 9050 00 03	105 mm	5	15



■ INFO



www.famispa.com

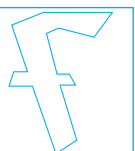

SHELVING SYSTEM SERIES NC-SYSTEM

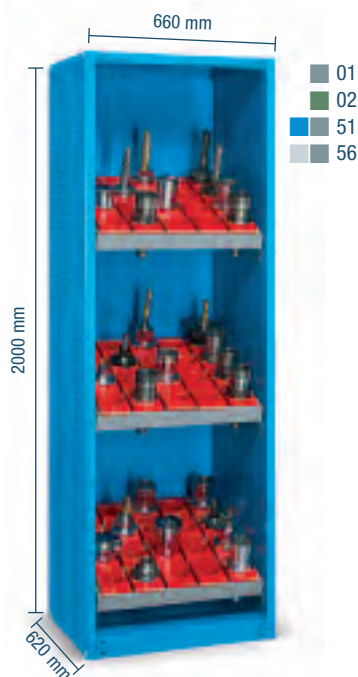

ORD. NO.

F NC 0120 01 51

Including:

3 frames 4-rows ORD. NO. **F NC 5220 00 01**

3 pair of carriers ORD. NO. **F NC 5741 00 01**

Load capacity of shelving system: 1500 kg

Dimensions mm 660x620x2000 h

Tool holders excluded

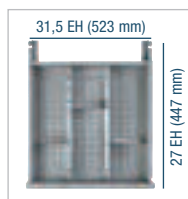

ORD. NO.

F NC 0220 01 51

DRAWERS

2

Including: 18 frames 1-row ORD. NO. **F NC 5020 00 01**

18 pair of angled carriers ORD. NO. **F NC 5711 00 99**

2 adjustable shelves ORD. NO. **F NC 3210 00 04**

2 telescopic extension drawers ORD. NO. **F NC 8610 00 04**

Load capacity of shelving system for compartment: 500 kg

Dimensions mm 1290x620x2000 h

Tool holders excluded

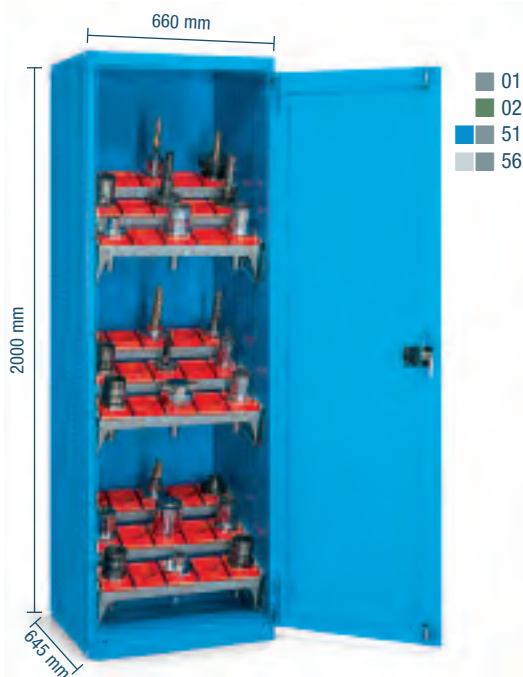

ORD. NO.

F NC 0121 01 51

Including: 9 frames 1-row ORD. NO. **F NC 5020 00 01**

9 pair of angled carriers ORD. NO. **F NC 5711 00 99**

Load capacity of shelving system: 1500 kg

Dimensions mm 660x645x2000 h

Tool holders excluded



ORD. NO.

F NC 0221 01 51

Including: 18 frames 1-row ORD. NO. **F NC 5020 00 01**

18 pair of angled carriers ORD. NO. **F NC 5711 00 99**

Load capacity of shelving system for compartment: 500 kg

Dimensions mm 1290x645x2000 h

Tool holders excluded

RAL 7000 F.01 RAL 6011 F.02 RAL 5012 RAL 7035 RAL 7000 F.51 RAL 7000 F.56

KEY ■

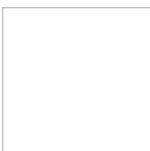
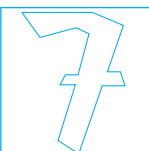

■ Partitioning material see page B47

- The shelving system must be fixed to the floor or to the wall
- All indicated loads are net and refer to evenly distributed weights



SHELVING SYSTEM SERIES NC-SYSTEM

EMPTY SHELVING SYSTEM SERIES F NC 0120 / F NC 0121



ORD. NO.
F NC 0120 00 04
Single shelving system
Load capacity of single shelving system: 1500 kg
Dim. mm 660x620x2000 h

ORD. NO.
F NC 0120 X0 04
Add-on shelving system
Load capacity of single shelving system + add-on: 500 kg for compartment
Dim. mm 630x620x2000 h



ORD. NO.
F NC 0121 00 04
Single shelving system with door
Load capacity of single shelving system: 1500 kg
Dim. mm 660x645x2000 h

ORD. NO.
F NC 0121 X0 04
Add-on shelving system with door
Load capacity of single shelving system+add-on: 500 kg for comp.
Dim. mm 630x645x2000 h

ADJUSTABLE SHELF



ORD. NO. **F NC 3210 01 04** **LOAD CAPACITY kg** 30
Overall dimensions mm 600x620x30 h

RUBBER MAT



ORD. NO. **F NC 3955 00 07**
Overall dimensions mm 595x615

FIXING SET

■ Fixing material including (for 1 upright frame) 2 steel floor bolts M8x75 mm for uninterrupted concrete floors equal to higher than class: B25 / RBK250 / MPA 25 N for mm².

ORD. NO. F NC 8999 00 99

■ The shelving system must be fixed to the floor or to the wall.

ALUMINIUM INSERT FOR SHELVING SYSTEM F NC 0120 / F NC 0121



ORD. NO. **F NC 2410 00 00**
Aluminium insert with rubber
Overall dimensions mm 525x135x45 h



Example of tool holder frame ORD. NO. **F NC 5020 00 ..** with aluminium support

KEY

RAL 7000 F.01 RAL 6011 F.02 RAL 5012 F.04 RAL 7035 F.08



- The shelving system must be fixed to the floor or to the wall
- All indicated loads are net and refer to evenly distributed weights



SHELVING SYSTEM SERIES NC-SYSTEM

TOOL HOLDER FRAMES 3-ROWS FOR DRAWERS FOR SHELVING SYSTEM F NC 0120 / F NC 0121

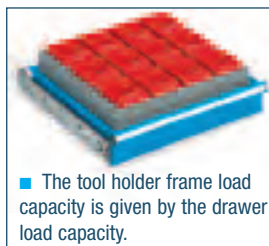
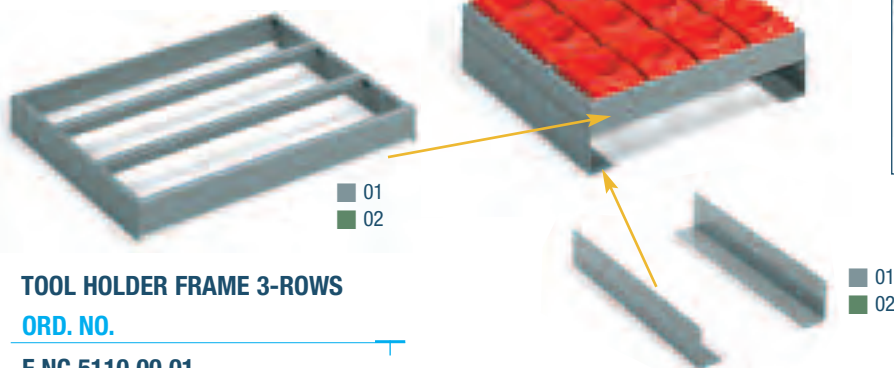

Example of drawer application with tool holder frame 3-rows
ORD. NO. **F NC 8610 00 04**
1 pair of carriers
ORD. NO. **F NC 5110 00 01**
and 12 tool holders ISO 50.

The tool holder frame load capacity is given by the drawer load capacity.

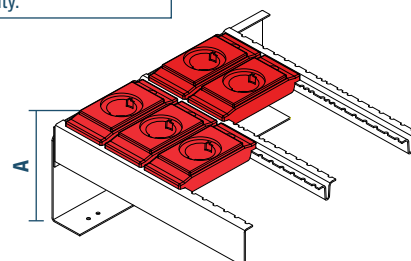

TOOL HOLDER FRAME 3-ROWS

ORD. NO.

F NC 5110 00 01

Overall dimensions mm 515x444x69 h

PAIR OF CARRIERS

ORD. NO.

DIMENSIONS mm

FOR LENGTH TAPERS MM REF. A

F NC 5630 00 01

446x86 h

A = 93 / 118 / 143

F NC 5830 00 01

446x136 h

A = 143 / 168 / 193

ORD. NO.
TOOL HOLDERS

TOOL HOLDER
TYPE

MAX. QUANTITY
PER TOOL FRAME
F NC 5110 00..

F NC 9510 00 03	ISO 30	21
F NC 9530 00 03	ISO 40	21
F NC 9540 00 03	ISO 45	15
F NC 9550 00 03	ISO 50	12
F NC 9560 00 03	VDI 30	21
F NC 9570 00 03	VDI 40	15
F NC 9580 00 03	VDI 50	15
F NC 9590 00 03	VDI 60	12
F NC 9720 00 03	MORSE TAPER 2	21
F NC 9730 00 03	MORSE TAPER 3	21

ORD. NO.
TOOL HOLDERS

TOOL HOLDER
TYPE

MAX. QUANTITY
PER TOOL FRAME
F NC 5110 00..

F NC 9740 00 03	MORSE TAPER 4	21
F NC 9750 00 03	MORSE TAPER 5	15
F NC 9270 00 03	CAPTO C3	21
F NC 9275 00 03	CAPTO C4	15
F NC 9280 00 03	CAPTO C5	15
F NC 9285 00 03	CAPTO C6	15
F NC 9290 00 03	CAPTO C8	12
F NC 9210 00 03	HSK A32-B40	21
F NC 9220 00 03	HSK A40-B50	21
F NC 9230 00 03	HSK A50-B63	15

ORD. NO.
TOOL HOLDERS

TOOL HOLDER
TYPE

MAX. QUANTITY
PER TOOL FRAME
F NC 5110 00..

F NC 9240 00 03	HSK A63-B80	15
F NC 9250 00 03	HSK A80-B100	12
F NC 9260 00 03	HSK A100-B125	12
F NC 9640 00 03	2"	15
F NC 9650 00 03	2" 1/4	12
F NC 9010 00 03	58 mm	24
F NC 9020 00 03	65 mm	21
F NC 9030 00 03	75 mm	18
F NC 9040 00 03	87 mm	15
F NC 9050 00 03	105 mm	12

31,5x27 EH FULL TELESCOPIC EXTENSION DRAWERS FOR SHELVING SYSTEM F NC 0120 / F NC 0121



ORD. NO.

USABLE DIM.
mm

FRONT
HEIGHT mm

LOAD CAPACITY
kg

F NC 8607 00 04

523x447x54 h

75

150

F NC 8610 00 04

523x447x79 h

100

150

F NC 8615 00 04

523x447x129 h

150

150

Extension: 100%

In the tool storage shelving system series **F NC 0120 / 121 / 220 / 221** drawers have to be assembled from the bottom to the top till a max. height of 1000 mm, paying attention that the load capacity of one drawer is 150 kg and that the total weight in all the drawers do not exceed 400 kg per compartment.

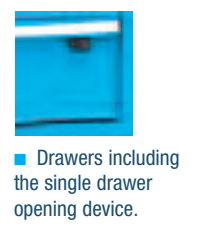

Drawers including the single drawer opening device.

Partitioning material see page **B47**

TOOL FOR WOODEN INSERT OF MULTIPLEX FOR SHELVING SYSTEM F NC 0120 / F NC 0121



01
02



TOOL FOR WOODEN INSERT OF MULTIPLEX

ORD. NO. **F NC 5021 00 01**

Horizontal frame load capacity: 50 kg

Overall dimensions mm 584x140x146 h

WOODEN INSERT OF MULTIPLEX

ORD. NO. **F NC 2510 00 00**

Overall dimensions mm 525x138x50 h



Example of tool holder frame
ORD. NO. **F NC 5021 00 ..**

SHELVING SYSTEM SERIES NC-SYSTEM

TOOL HOLDER FRAME AND ACCESSORIES FOR SHELVING SYSTEM F NC 0120 / F NC 0121



TOOL HOLDER FRAME

ORD. NO. F NC 5020 00 01

Horizontal frame load capacity: 50 kg

Dimensions mm 584x140x146 h



PAIR OF GALVANISED HANDLES

ORD. NO. F NC 5005 00 99

For frame ORD. NO. F NC 5020 00 ..



PAIR OF GALVANISED HORIZONTAL CARRIERS

ORD. NO. F NC 5710 00 99

For frame ORD. NO. F NC 5020 00 ..

Overall dimensions mm 140x150 h



PAIR OF GALVANISED ANGLED CARRIERS

ORD. NO. F NC 5711 00 99

For frame ORD. NO. F NC 5020 00 ..

Overall dimensions mm 140x150 h

TOOL HOLDER FRAME 4-ROWS AND ACCESSORIES FOR SHELVING SYSTEM F NC 0120 / F NC 0121



TOOL HOLDER FRAME 4-ROWS

ORD. NO.

F NC 5220 00 01

Horizontal frame load capacity: 150 kg

Overall dimensions mm 584x592x69 h



HORIZONTAL PAIR OF CARRIERS

ORD. NO.

F NC 5640 00 01

For frame ORD. NO. F NC 5220 00 ..

Overall dimensions mm 577x112 h

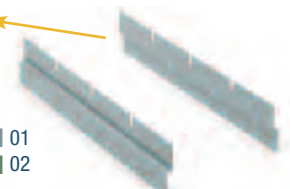

ANGLED PAIR OF CARRIERS

ORD. NO.

F NC 5741 00 01

For frame ORD. NO. F NC 5220 00 ..

Overall dimensions mm 577x114 h



ORD. NO. TOOL HOLDERS

ORD. NO. TOOL HOLDERS	TOOL HOLDER TYPE	MAX. QUANTITY PER TOOL FRAME F NC 5020 00 ..	MAX. QUANTITY PER TOOL FRAME F NC 5220 00 ..
F NC 9510 00 03	ISO 30	7	32
F NC 9530 00 03	ISO 40	7	32
F NC 9540 00 03	ISO 45	5	24
F NC 9550 00 03	ISO 50	5	20
F NC 9560 00 03	VDI 30	7	32
F NC 9570 00 03	VDI 40	5	24
F NC 9580 00 03	VDI 50	5	24
F NC 9590 00 03	VDI 60	5	20
F NC 9720 00 03	MORSE TAPER 2	7	32
F NC 9730 00 03	MORSE TAPER 3	7	32
F NC 9740 00 03	MORSE TAPER 4	7	32
F NC 9750 00 03	MORSE TAPER 5	5	24
F NC 9270 00 03	CAPTO C3	7	32
F NC 9275 00 03	CAPTO C4	5	24
F NC 9280 00 03	CAPTO C5	5	24

ORD. NO. TOOL HOLDERS

ORD. NO. TOOL HOLDERS	TOOL HOLDER TYPE	MAX. QUANTITY PER TOOL FRAME F NC 5020 00 ..	MAX. QUANTITY PER TOOL FRAME F NC 5220 00 ..
F NC 9285 00 03	CAPTO C6	5	24
F NC 9290 00 03	CAPTO C8	4	16
F NC 9210 00 03	HSK A32-B40	7	32
F NC 9220 00 03	HSK A40-B50	7	32
F NC 9230 00 03	HSK A50-B63	5	24
F NC 9240 00 03	HSK A63-B80	5	24
F NC 9250 00 03	HSK A80-B100	4	16
F NC 9260 00 03	HSK A100-B125	4	16
F NC 9640 00 03	2"	5	24
F NC 9650 00 03	2" 1/4	5	20
F NC 9010 00 03	58 mm	9	36
F NC 9020 00 03	65 mm	8	32
F NC 9030 00 03	75 mm	7	28
F NC 9040 00 03	87 mm	6	24
F NC 9050 00 03	105 mm	5	20

SHELVING SYSTEM SERIES NC-SYSTEM

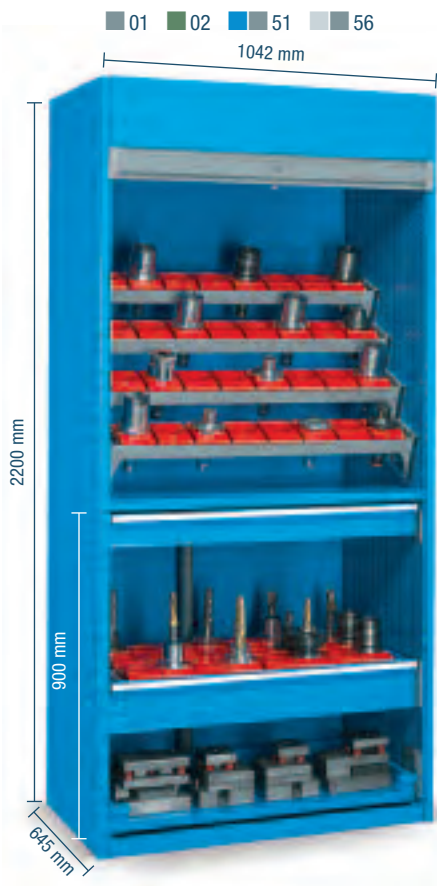

ORD. NO.

F NC 0822 01 51

Including:

- 4 frames 1-row ORD. NO. **F NC 5050 00 01**
- 4 angled pair of carriers ORD. NO. **F NC 5711 00 99**
- 1 telescopic extension drawer
ORD. NO. **F NC 8910 00 04**
- 1 tool frame a 3 file ORD. NO. **F NC 5140 00 01**
- 1 pair of carriers ORD. NO. **F NC 5630 00 01**
- 1 telescopic extension drawer
ORD. NO. **F NC 8915 00 04**
- 1 telescopic retract. shelf ORD. NO. **F NC 8660 00 04**
- Load capacity of shelving system: 1500 kg
- Dimensions mm 1042x645x2200 h**

Tool holders excluded

ORD. NO.

F NC 0822 04 51

Including:

- 8 frames 1-row ORD. NO. **F NC 5050 00 01**
- 8 pair of angled carriers ORD. NO. **F NC 5711 00 99**
- Load capacity of shelving system: 1500 kg
- Dimensions mm 1042x645x2200 h**

Tool holders excluded

ORD. NO.

F NC 0822 06 51

Including:

- 4 frames 4-rows ORD. NO. **F NC 5250 00 01**
- 4 pair of angled carriers ORD. NO. **F NC 5741 00 01**
- Load capacity of shelving system: 1500 kg
- Dimensions mm 1042x645x2200 h**

Tool holders excluded

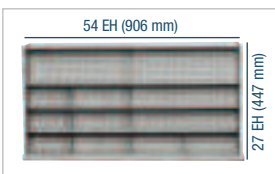

■ Detail of roller shutter door

RAL 7000 F.01 RAL 6011 F.02 RAL 5012 + RAL 7000 F.51 RAL 7035 + RAL 7000 F.56

INFO ■

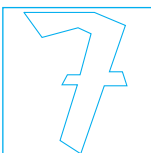

■ Partitioning material see page B46

www.famispa.com

DIMENSIONS = 1042x645x2200 mm

SHELVING SYSTEM SERIES NC-SYSTEM

01 02 51 56

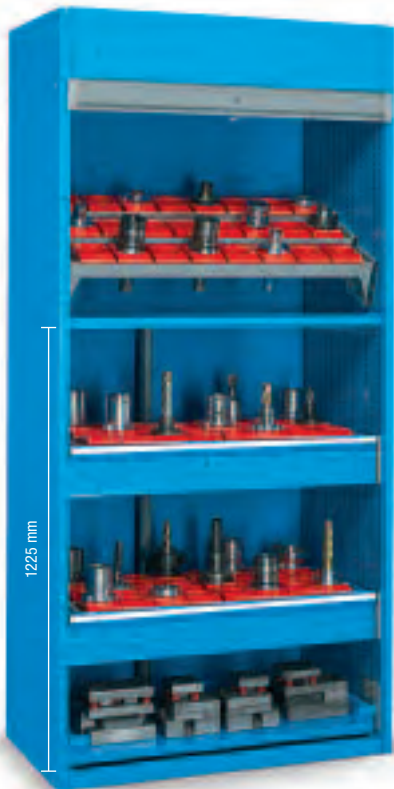

ORD. NO. F NC 0822 13 51

ORD. NO.

F NC 0822 13 51

- Including:
- 3 frames 1-row ORD. NO. F NC 5050 00 01
 - 3 pair of angled carriers ORD. NO. F NC 5711 00 99
 - 2 frames 3-rows ORD. NO. F NC 5140 00 01
 - 2 pair of carriers ORD. NO. F NC 5630 00 01
 - 2 telescopic extension drawers
ORD. NO. F NC 8915 00 04
 - 1 telescopic retract. shelf ORD. NO. F NC 8660 00 04
- Load capacity of shelving system: 1500 kg
- Dimensions mm 1042x645x2200 h**
- Tool holders excluded

ORD. NO.

F NC 0822 12 51

- Including:
- 4 frames 3-rows ORD. NO. F NC 5140 00 01
 - 4 pair of carriers ORD. NO. F NC 5630 00 01
 - 4 telescopic extension drawers
ORD. NO. F NC 8915 00 04
- Dimensions mm 1042x645x2200 h**
- Tool holders excluded

01 02 51 56



ORD. NO. F NC 0822 12 51



ORD. NO.
TOOL HOLDERS

TOOL HOLDER
TYPE

MAX. QUANTITY PER
TOOL FRAME F NC 5050 00 ..

MAX. QUANTITY PER
TOOL FRAME F NC 5140 00 ..

MAX. QUANTITY PER
TOOL FRAME F NC 5250 00 ..

ORD. NO. TOOL HOLDERS	TOOL HOLDER TYPE	MAX. QUANTITY PER TOOL FRAME F NC 5050 00 ..	MAX. QUANTITY PER TOOL FRAME F NC 5140 00 ..	MAX. QUANTITY PER TOOL FRAME F NC 5250 00 ..
F NC 9510 00 03	ISO 30	12	33	48
F NC 9530 00 03	ISO 40	12	33	48
F NC 9540 00 03	ISO 45	10	27	40
F NC 9550 00 03	ISO 50	8	24	32
F NC 9560 00 03	VDI 30	12	33	48
F NC 9570 00 03	VDI 40	10	27	40
F NC 9580 00 03	VDI 50	10	27	40
F NC 9590 00 03	VDI 60	8	24	32
F NC 9720 00 03	MORSE TAPER 2	12	33	48
F NC 9730 00 03	MORSE TAPER 3	12	33	48
F NC 9740 00 03	MORSE TAPER 4	12	33	48
F NC 9750 00 03	MORSE TAPER 5	10	27	40
F NC 9270 00 03	CAPTO C3	12	33	48
F NC 9275 00 03	CAPTO C4	10	27	40
F NC 9280 00 03	CAPTO C5	10	27	40
F NC 9285 00 03	CAPTO C6	10	27	40
F NC 9290 00 03	CAPTO C8	8	21	32
F NC 9210 00 03	HSK A32-B40	12	33	48
F NC 9220 00 03	HSK A40-B50	12	33	48
F NC 9230 00 03	HSK A50-B63	10	27	40
F NC 9240 00 03	HSK A63-B80	10	27	40
F NC 9250 00 03	HSK A80-B100	8	21	32
F NC 9260 00 03	HSK A100-B125	8	21	32
F NC 9640 00 03	2"	10	27	40
F NC 9650 00 03	2" 1/4	8	24	32
F NC 9010 00 03	58 mm	15	42	60
F NC 9020 00 03	65 mm	14	39	56
F NC 9030 00 03	75 mm	12	33	48
F NC 9040 00 03	87 mm	10	27	40
F NC 9050 00 03	105 mm	8	24	32

SHELVING SYSTEM SERIES NC-SYSTEM

EMPTY SHELVING SYSTEM SERIES F NC 0822



ORD. NO.	ANTI-TILT ROD LENGTH
F NC 0822 00 04	-
Load capacity: 1500 kg	
Dim. mm 1042x645x2200 h	



ORD. NO.	ANTI-TILT ROD LENGTH
F NC 0822 11 04	900 mm
F NC 0822 10 04	1225 mm
Load capacity: 1500 kg	
Dim. mm 1042x645x2200 h	



ORD. NO.	ANTI-TILT ROD LENGTH
F NC 0822 09 04	1900 mm
Load capacity: 1500 kg	
Dim. mm 1042x645x2200 h	

FIXING SET



■ Fixing material including (for 1 upright frame) 2 steel floor bolts M8x75 mm for uninterrupted concrete floors equal to higher than class: B25 / RBK250 / MP_A 25 N for mm².

ORD. NO. **F NC 8999 00 99**

■ The shelving system must be fixed to the floor or to the wall.



■ Detail of roller shutter door

PLINTHS FOR TRANSPALLET FOR SHELVING SYSTEM F NC 0822



ORD. NO.	
F NC 8410 00 07	Plinth height 100 mm
F NC 8430 00 07	Facing piece

RAL 7000 F.01 RAL 6011 F.02 RAL 5012 F.04 RAL 7035 F.08

KEY ■

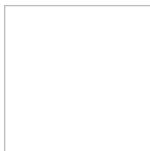
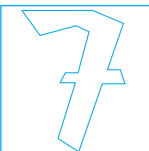

- The shelving system must be fixed to the floor or to the wall
- All indicated loads are net and refer to evenly distributed weights



DIMENSIONS = 1042x645x2200 mm

SHELVING SYSTEM SERIES NC-SYSTEM

ADJUSTABLE SHELF FOR SHELVING SYSTEM WITHOUT ANTI-TILT ROD F NC 0822

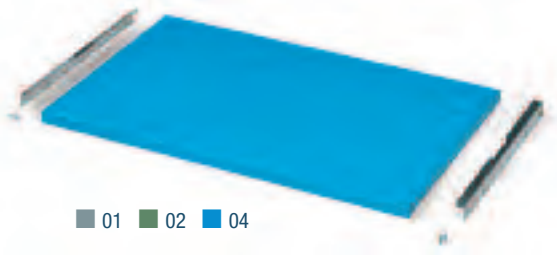

ORD. NO.	OVERALL DIMENSIONS mm	LOAD CAPACITY kg
F NC 3810 01 04	980x625x30 h	100

■ 01 ■ 02 ■ 04

ADJUSTABLE SHELF FOR SHELVING SYSTEM WITH ANTI-TILT ROD F NC 0822

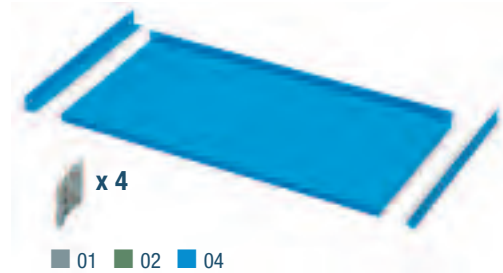

ORD. NO.	USABLE DIMENSIONS mm	SIDE HEIGHT mm	LOAD CAPACITY kg
F SR 1220 01 04	967x465	25	100
Extension: 100%			

x 4

■ 01 ■ 02 ■ 04

54x27 EH FULL TELESCOPIC EXTENSION DRAWERS FOR SHELVING SYSTEM F NC 0822

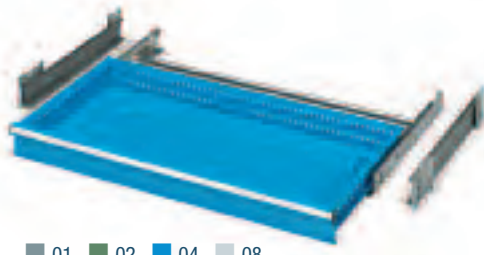

ORD. NO.	USABLE DIMENSIONS mm	FRONT HEIGHT mm	LOAD CAPACITY kg
F NC 8907 00 04	906x447x54 h	75	150
F NC 8910 00 04	906x447x79 h	100	150
F NC 8915 00 04	906x447x129 h	150	150
Extension: 100%			

■ 01 ■ 02 ■ 04 ■ 08

■ Drawers can be assembled in shelvings with anti-tilt rod.

■ Partitioning material see page B46

54x27 EH FULL TELESCOPIC EXTENSION SHELVES FOR SHELVING SYSTEM F NC 0822

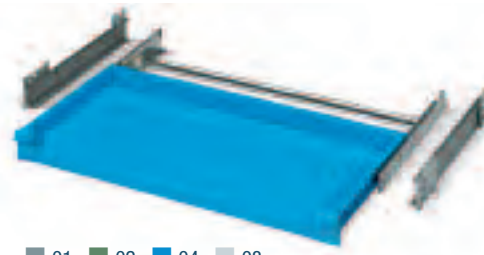

ORD. NO.	USABLE DIMENSIONS mm	FRONT HEIGHT mm	LOAD CAPACITY kg
F NC 8660 00 04	916x457 h	85	150
Extension: 100%			

■ 01 ■ 02 ■ 04 ■ 08

■ Full telescopic extension shelves must be assembled in shelvings with anti-tilt rod.

■ KEY

■ RAL 7000 F.01 ■ RAL 6011 F.02 ■ RAL 5012 F.04 ■ RAL 7035 F.08



■ All indicated loads are net and refer to evenly distributed weights

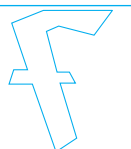

SHELVING SYSTEM SERIES NC-SYSTEM

TOOL HOLDER FRAME 4-ROWS AND ACCESSORIES FOR SHELVING SYSTEM F NC 0822

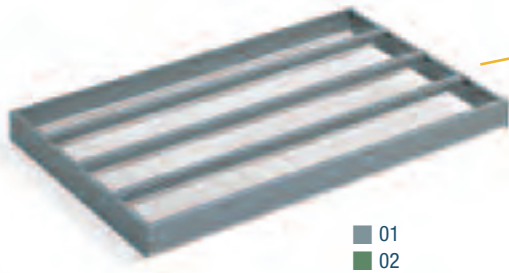

TOOL HOLDER FRAME 4-ROWS

ORD. NO.

F NC 5250 00 01

Horizontal frame load capacity: 150 kg

Overall dimensions mm 966x592x69 h

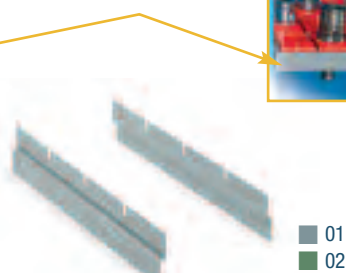

HORIZONTAL PAIR OF CARRIERS

ORD. NO.

F NC 5640 00 01

For frame ORD. NO. F NC 5250 00 ..

Overall dimensions mm 577x112 h



ANGLED PAIR OF CARRIERS

ORD. NO.

F NC 5741 00 01

For frame ORD. NO. F NC 5250 00 ..

Overall dimensions mm 577x114 h

TOOL HOLDER FRAME AND ACCESSORIES FOR SHELVING SYSTEM F NC 0822

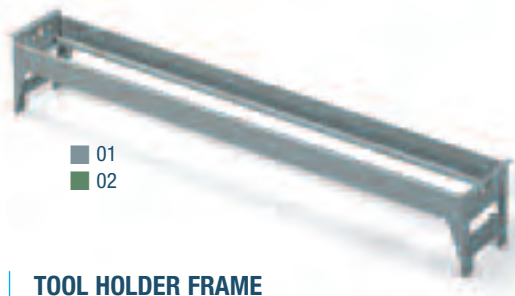

TOOL HOLDER FRAME

ORD. NO.

F NC 5050 00 01

Horizontal frame load capacity: 80 kg

Dimensions mm 968x140x146 h



PAIR OF GALVANISED HANDLES

ORD. NO.

F NC 5005 00 99

For frame ORD. NO. F NC 5050 00 ..



PAIR OF GALVANISED HORIZONTAL CARRIERS

ORD. NO.

F NC 5710 00 99

For frame ORD. NO. F NC 5050 00 ..

Overall dimensions mm 140x150 h



PAIR OF GALVANISED ANGLED CARRIERS

ORD. NO.

F NC 5711 00 99

For frame ORD. NO. F NC 5050 00 ..

Overall dimensions mm 140x150 h

RAL 7000 F.01 RAL 6011 F.02

KEY ■

■ All indicated loads are net and refer to evenly distributed weights

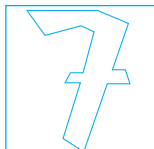

DIMENSIONS = 1042x645x2200 mm

SHELVING SYSTEM SERIES NC-SYSTEM

TOOL HOLDER FRAME 3-ROWS FOR DRAWERS FOR SHELVING SYSTEM F NC 0822

- 01
- 02

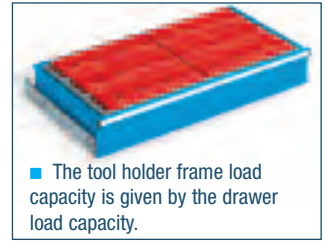
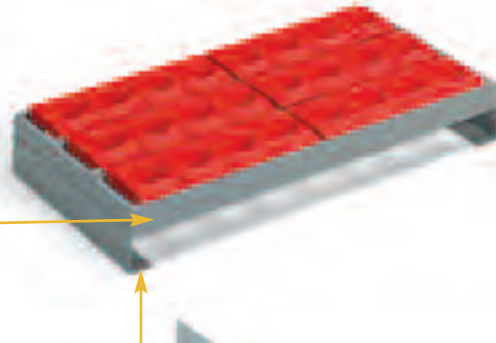

TOOL HOLDER FRAME 3-ROWS

ORD. NO.

F NC 5140 00 01

Overall dimensions mm 890x444x69 h

PAIR OF CARRIERS

ORD. NO.

F NC 5630 00 01

DIMENSIONS mm

446x86 h

FOR LENGTH TAPERS MM REF. A

A = 93 / 118 / 143

F NC 5830 00 01

446x136 h

A = 143 / 168 / 193

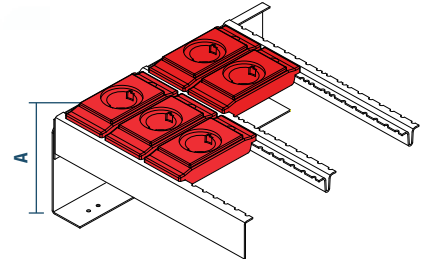

ORD. NO.
TOOL HOLDERS

TOOL HOLDER
TYPE

MAX. QUANTITY PER
TOOL FRAME F NC 5050 00 ..

MAX. QUANTITY PER
TOOL FRAME F NC 5140 00 ..

MAX. QUANTITY PER
TOOL FRAME F NC 5250 00 ..

F NC 9510 00 03	ISO 30	12	33	48
F NC 9530 00 03	ISO 40	12	33	48
F NC 9540 00 03	ISO 45	10	27	40
F NC 9550 00 03	ISO 50	8	24	32
F NC 9560 00 03	VDI 30	12	33	48
F NC 9570 00 03	VDI 40	10	27	40
F NC 9580 00 03	VDI 50	10	27	40
F NC 9590 00 03	VDI 60	8	24	32
F NC 9720 00 03	MORSE TAPER 2	12	33	48
F NC 9730 00 03	MORSE TAPER 3	12	33	48
F NC 9740 00 03	MORSE TAPER 4	12	33	48
F NC 9750 00 03	MORSE TAPER 5	10	27	40
F NC 9270 00 03	CAPTO C3	12	33	48
F NC 9275 00 03	CAPTO C4	10	27	40
F NC 9280 00 03	CAPTO C5	10	27	40
F NC 9285 00 03	CAPTO C6	10	27	40
F NC 9290 00 03	CAPTO C8	8	21	32
F NC 9210 00 03	HSK A32-B40	12	33	48
F NC 9220 00 03	HSK A40-B50	12	33	48
F NC 9230 00 03	HSK A50-B63	10	27	40
F NC 9240 00 03	HSK A63-B80	10	27	40
F NC 9250 00 03	HSK A80-B100	8	21	32
F NC 9260 00 03	HSK A100-B125	8	21	32
F NC 9640 00 03	2"	10	27	40
F NC 9650 00 03	2" 1/4	8	24	32
F NC 9010 00 03	58 mm	15	42	60
F NC 9020 00 03	65 mm	14	39	56
F NC 9030 00 03	75 mm	12	33	48
F NC 9040 00 03	87 mm	10	27	40
F NC 9050 00 03	105 mm	8	24	32

■ INFO

RAL 7000 F.01 RAL 6011 F.02



www.famispa.com



SHELVING SYSTEM SERIES NC-SYSTEM

SET OF PARTITIONS FOR DRAWERS 54x27 EH

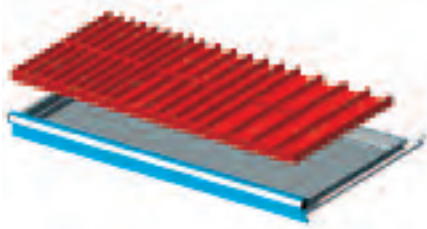

ORD. NO.	FOR FRONT HEIGHTS
F FH 4005 12 00	75-150
Set including:	
6 Throughs	4 grooves
15 Through dividers	36 mm
6 Throughs	3 grooves
10 Plain partitions	47 mm
6 Throughs	2 grooves
6 Plain partitions	73 mm

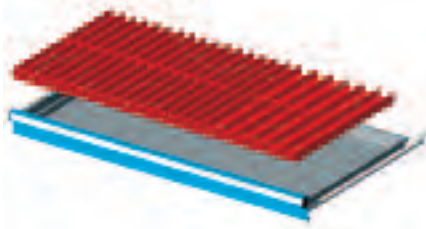

ORD. NO.	FOR FRONT HEIGHTS
F FH 4005 15 00	75-150
Set including:	
12 Throughs	4 grooves
30 Through dividers	36 mm
6 Throughs	3 grooves
10 Plain partitions	47 mm

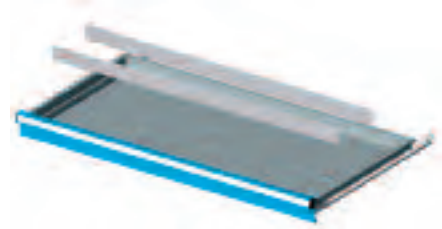

ORD. NO.	FOR FRONT HEIGHTS
F FH 4007 01 00	75
F FH 4010 01 00	100
F FH 4015 01 00	150
Set including:	
2 Plain partitions	914 mm



ORD. NO.	FOR FRONT HEIGHTS
F FH 4007 03 00	75
F FH 4010 03 00	100
F FH 4015 03 00	150
Set including:	
5 Slotted partitions	455 mm
12 Plain partitions	149 mm



ORD. NO.	FOR FRONT HEIGHTS
F FH 4007 04 00	75
F FH 4010 04 00	100
F FH 4015 04 00	150
Set including:	
4 Plain partitions	455 mm

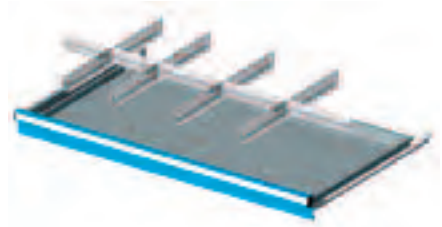

ORD. NO.	FOR FRONT HEIGHTS
F FH 4007 05 00	75
F FH 4010 05 00	100
F FH 4015 05 00	150
Set including:	
4 Slotted partitions	455 mm
2 Plain partitions	149 mm
3 Plain partitions	200 mm

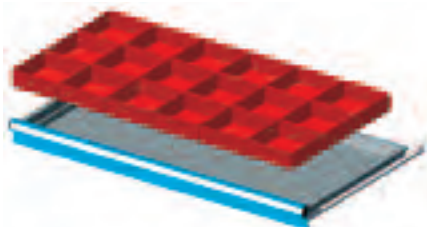

ORD. NO.	FOR FRONT HEIGHTS
F FH 4007 11 00	75
F FH 4010 11 00	100
Set including:	
18 Plastic boxes	150x150 mm

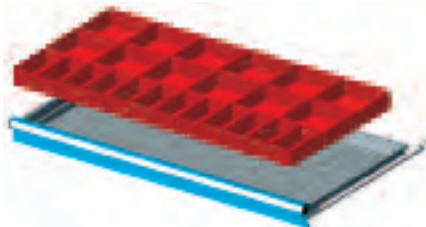

ORD. NO.	FOR FRONT HEIGHTS
F FH 4007 13 00	75
F FH 4010 13 00	100
Set including:	
12 Plastic boxes	150x75 mm
12 Plastic boxes	150x150 mm

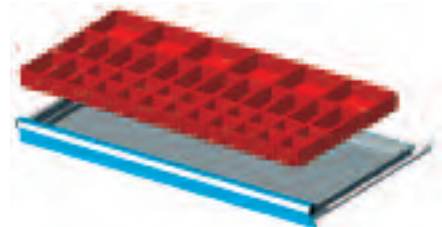

ORD. NO.	FOR FRONT HEIGHTS
F FH 4007 16 00	75
Set including:	
20 Plastic boxes	75x75 mm
14 Plastic boxes	150x75 mm
6 Plastic boxes	150x150 mm

KEY ■

■ Partitioning material see page A180

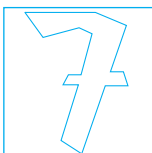

31,5x27 EH

SHELVING SYSTEM SERIES NC-SYSTEM

SET OF PARTITIONS FOR DRAWERS 31,5x27 EH

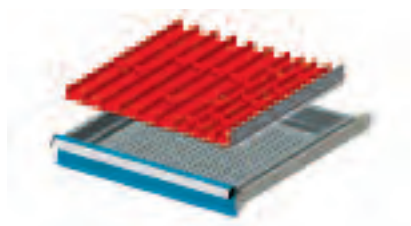

ORD. NO. FOR FRONT HEIGHTS

F FH 8707 01 00 75-150

Set including:

3 Throughs	4 grooves
6 Throughs	3 grooves
16 Through dividers	36 mm
7 Plain partitions	47 mm
1 Plain partition	455 mm

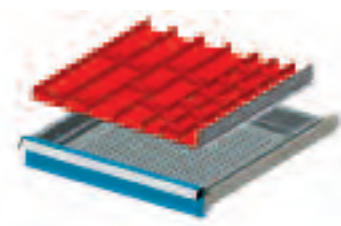

ORD. NO. FOR FRONT HEIGHTS

F FH 8707 02 00 75-150

Set including:

3 Throughs	3 grooves
6 Throughs	2 grooves
15 Through dividers	47 mm
8 Plain partitions	73 mm
1 Plain partition	455 mm

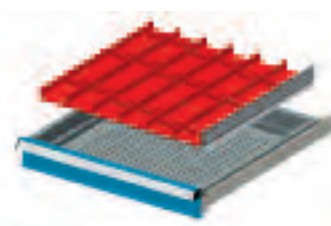

ORD. NO. FOR FRONT HEIGHTS

F FH 8707 03 00 75-150

Set including:

9 Throughs	2 grooves
18 Through dividers	73 mm
1 Plain partition	455 mm

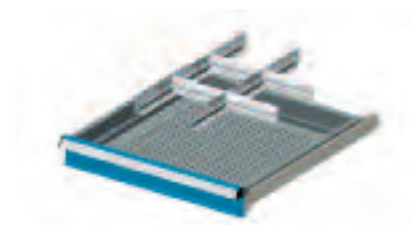

ORD. NO. FOR FRONT HEIGHTS

F FH 8707 04 00 75

F FH 8710 04 00 100

F FH 8715 04 00 150

Set including:

2 Slotted partitions	455 mm
4 Plain partitions	149 mm

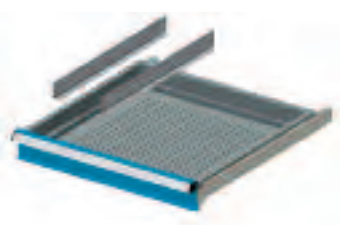

ORD. NO. FOR FRONT HEIGHTS

F FH 8407 13 00 75

F FH 8410 13 00 100

F FH 8415 13 00 150

Set including:

2 Plain partitions	455 mm
--------------------	--------

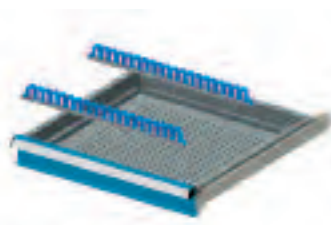

ORD. NO. FOR FRONT HEIGHTS

F FH 8605 19 00 75-150

Set including:

2 Multi-purpose supports	440 mm
--------------------------	--------

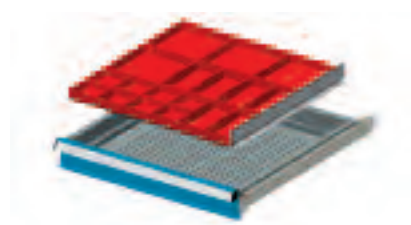

ORD. NO. FOR FRONT HEIGHTS

F FH 8707 05 00 75

Set including:

8 Plastic boxes	75x75 mm
6 Plastic boxes	150x75 mm
4 Plastic boxes	150x150 mm
1 Plain partition	455 mm

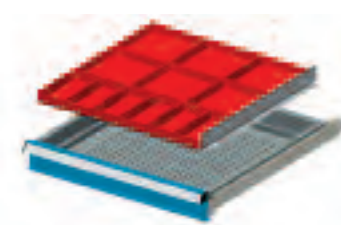

ORD. NO. FOR FRONT HEIGHTS

F FH 8707 06 00 75

F FH 8710 06 00 100

Set including:

6 Plastic boxes	150x75 mm
6 Plastic boxes	150x150 mm
1 Plain partition	455 mm



■ KEY



■ Partitioning material see page A180

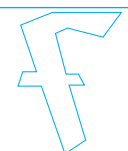

CABINETS SERIES NC-STANDARD F27

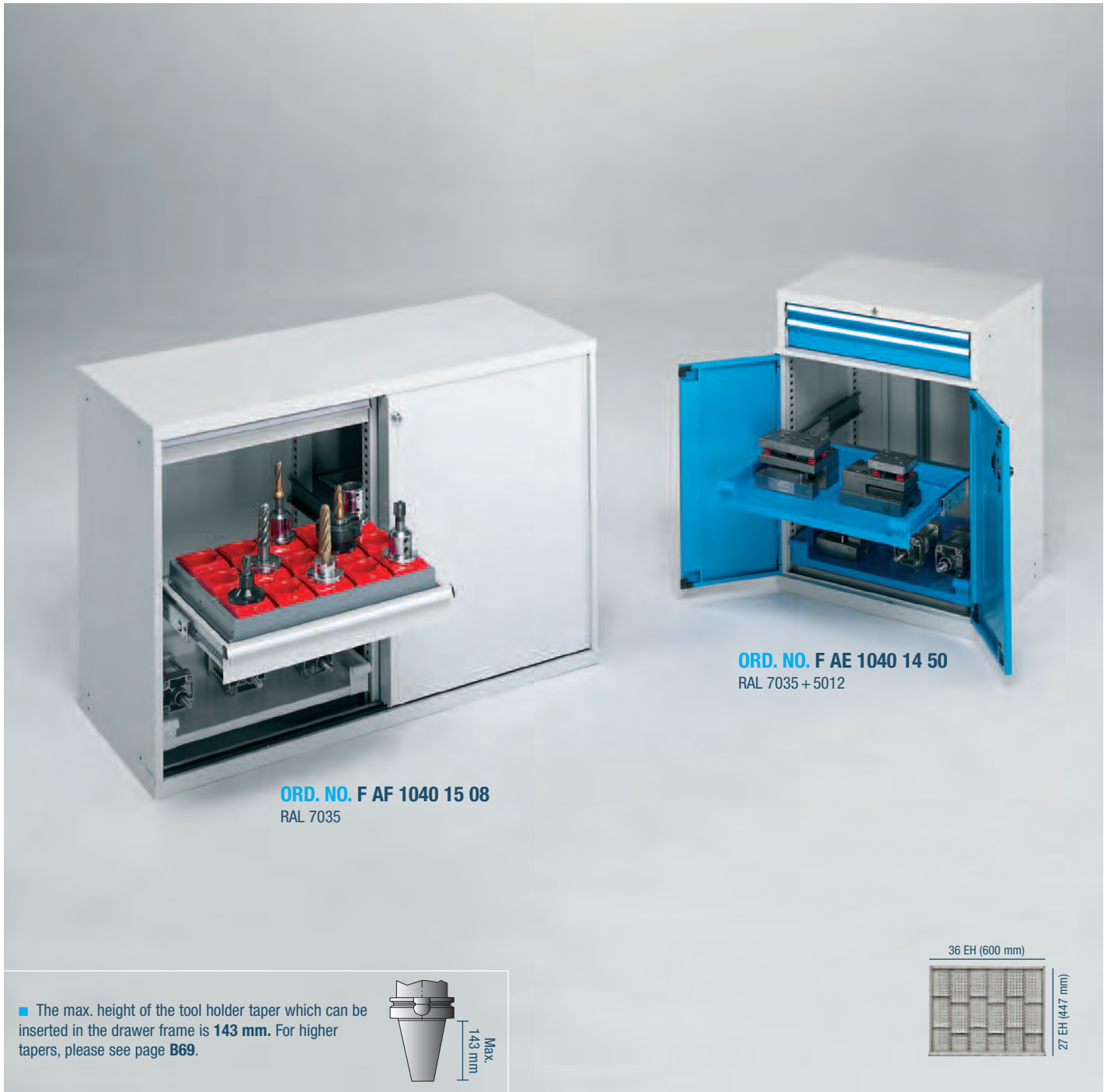

ORD. NO. F AF 1040 15 08
RAL 7035

ORD. NO. F AE 1040 14 50
RAL 7035 + 5012

■ The max. height of the tool holder taper which can be inserted in the drawer frame is **143 mm**. For higher tapers, please see page **B69**.

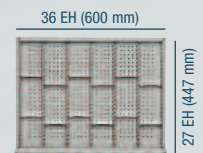
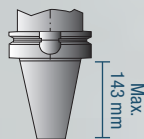

FLOOR FIXING SET



2x

- 2 "HILTI" plugs for concrete floors \geq to classes B25/RBK250/MP_A 25 N/mm²
- Recommended traction of the plug: 2.9 KN
- Plug diameter: \varnothing 6 mm

ORD. NO. F AG 9204 00 99

CABINET WITH SLIDING DOORS

ORD. NO.	DRAWERS
F AF 1040 15 08	4
Including 4 drawers	
2 retractable shelves	
2 tool holder frames	
Dimensions mm 1431x632x1000 h	
Tools and tool holders excluded	

CABINET WITH LEAF DOORS

ORD. NO.	DRAWERS
F AE 1040 14 50	2
Including 2 drawers	
2 retractable shelves	
Dimensions mm 717x597x1000 h	
Tools excluded	

RAL 7000 F.01

RAL 6011 F.02

RAL 5012 F.04

RAL 7035 F.08

SUPPLEMENTARY PARTS ■

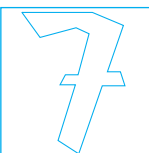

- **Spare key.** Always indicate the number on the cylinder lock of the key to be replaced.
ORD. NO. R CSC 0002 00
- **Master key.** This type of key opens all the 45 and 46 series locks.
ORD. NO. R CSC 0001 00



LENGTH = 717 mm DEPTH = 597/632 mm (36x27 Eh)

CABINETS SERIES NC-STANDARD F27

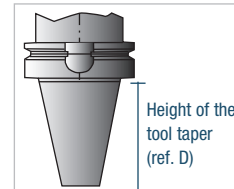
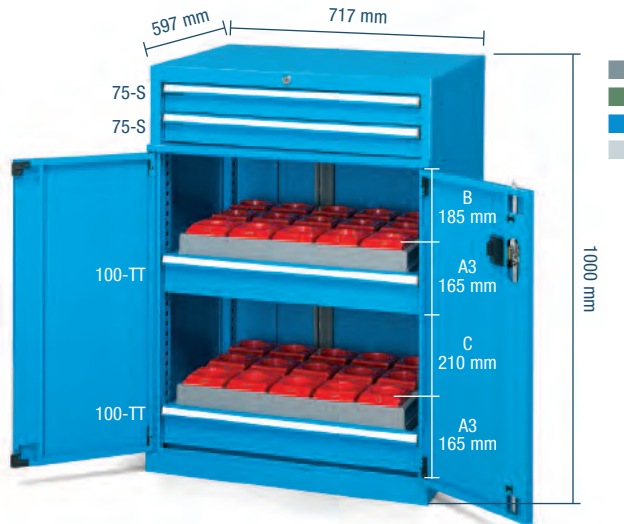

ORD. NO.

F AE 1040 17 04

Including:

2 normal extension drawers ORD. NO. **F FG 1007 00 04**

2 telescopic extension drawers ORD. NO. **F FG 1110 00 04**

2 frames 3-rows ORD. NO. **F NC 5120 00 01**

2 pairs of carriers ORD. NO. **F NC 5630 00 01**

Dimensions mm 717x597x1000 h

Tools excluded

THE TOOL FRAME CAN BE ADJUSTED IN 3 DIFFERENT HEIGHTS

	Height frame with drawer	Usable height	Max. height of the tool taper
A1	115 mm	B 235 mm	D 93 mm
A2	140 mm	B 210 mm	D 118 mm
A3	165 mm	B 185 mm	D 143 mm
A1	115 mm	C 260 mm	D 93 mm
A2	140 mm	C 235 mm	D 118 mm
A3	165 mm	C 210 mm	D 143 mm

The adjustment pitch of the drawer is 25 mm in height.

Height drawer with frame

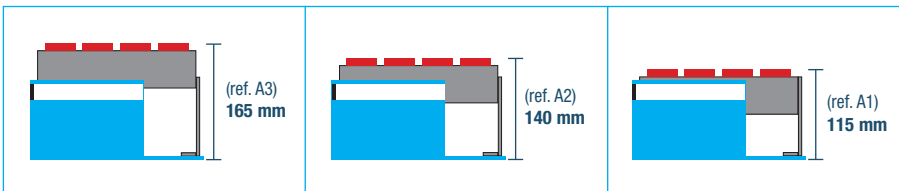

ORD. NO. TOOL HOLDERS

TOOL HOLDER TYPE

MAX. QUANTITY PER TOOL FRAME F NC 5120 00 ..

F NC 9510 00 03	ISO 30	24
F NC 9530 00 03	ISO 40	24
F NC 9540 00 03	ISO 45	18
F NC 9550 00 03	ISO 50	15
F NC 9560 00 03	VDI 30	24
F NC 9570 00 03	VDI 40	18
F NC 9580 00 03	VDI 50	18
F NC 9590 00 03	VDI 60	15
F NC 9720 00 03	MORSE TAPER 2	24
F NC 9730 00 03	MORSE TAPER 3	24
F NC 9740 00 03	MORSE TAPER 4	24
F NC 9750 00 03	MORSE TAPER 5	18
F NC 9270 00 03	CAPTO C3	24
F NC 9275 00 03	CAPTO C4	18
F NC 9280 00 03	CAPTO C5	18

ORD. NO. TOOL HOLDERS

TOOL HOLDER TYPE

MAX. QUANTITY PER TOOL FRAME F NC 5120 00 ..

F NC 9285 00 03	CAPTO C6	18
F NC 9290 00 03	CAPTO C8	12
F NC 9210 00 03	HSK A32-B40	24
F NC 9220 00 03	HSK A40-B50	24
F NC 9230 00 03	HSK A50-B63	18
F NC 9240 00 03	HSK A63-B80	18
F NC 9250 00 03	HSK A80-B100	12
F NC 9260 00 03	HSK A100-B125	12
F NC 9640 00 03	2"	18
F NC 9650 00 03	2" 1/4	15
F NC 9010 00 03	58 mm	27
F NC 9020 00 03	65 mm	24
F NC 9030 00 03	75 mm	21
F NC 9040 00 03	87 mm	18
F NC 9050 00 03	105 mm	15

KEY

RAL 7000 F.01 RAL 6011 F.02 RAL 5012 F.04 RAL 7035 F.08



- **S** = normal extension (87%)
- **TT** = telescopic full extension (100%)
- All indicated loads are net and refer to evenly distributed weights



■ Tool frame in the lowest position

■ Partitioning material see page **B57**



CABINETS SERIES NC-STANDARD F27

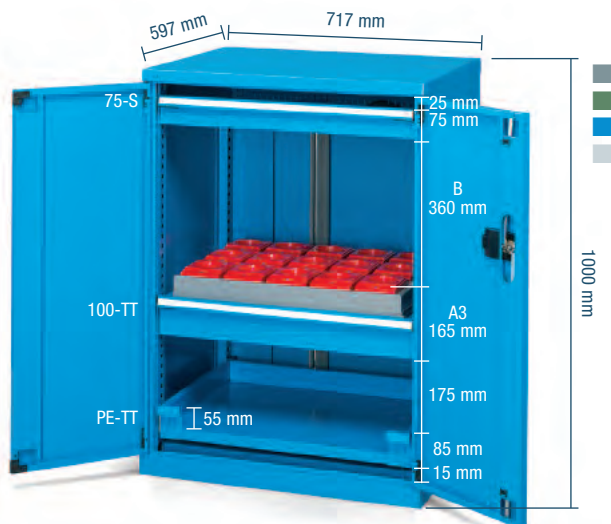

ORD. NO.

F AE 2040 14 04

- Including: 1 normal extension drawer ORD. NO. **F FG 1007 00 04**
 - 1 telescopic extension drawer ORD. NO. **F FG 1110 00 04**
 - 1 telescopic retractable shelf ORD. NO. **F FG 8110 00 04**
 - 1 frame 3-rows ORD. NO. **F NC 5120 00 01**, 1 pair of carriers ORD. NO. **F NC 5630 00 01**
- Dimensions mm 717x597x1000 h Tools excluded

ORD. NO.

F AE 2040 15 04

- Including: 1 normal extension drawer ORD. NO. **F FG 1010 00 04**
 - 2 telescopic extension drawers ORD. NO. **F FG 1110 00 04**
 - 2 frames 3-rows ORD. NO. **F NC 5120 00 01**
 - 2 pairs of carriers ORD. NO. **F NC 5630 00 01**
- Dimensions mm 717x597x1000 h Tools excluded

THE TOOL FRAME CAN BE ADJUSTED IN 3 DIFFERENT HEIGHTS

Height frame with drawer	Usable height	Max. height of the tool taper
A1 115 mm	B 410 mm	D 93 mm
A2 140 mm	B 385 mm	D 118 mm
A3 165 mm	B 360 mm	D 143 mm

The adjustment pitch of the drawer is 25 mm in height.

THE TOOL FRAME CAN BE ADJUSTED IN 3 DIFFERENT HEIGHTS

Height frame with drawer	Usable height	Max. height of the tool taper
A1 115 mm	B 260 mm	D 93 mm
A2 140 mm	B 235 mm	D 118 mm
A3 165 mm	B 210 mm	D 143 mm
A1 115 mm	C 285 mm	D 93 mm
A2 140 mm	C 260 mm	D 118 mm
A3 165 mm	C 235 mm	D 143 mm

The adjustment pitch of the drawer is 25 mm in height.

Height drawer with frame

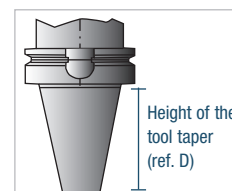
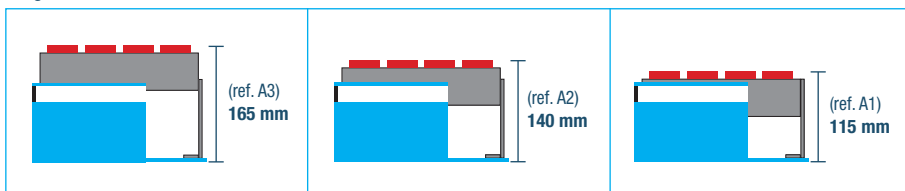

ORD. NO. TOOL HOLDERS

TOOL HOLDER TYPE
MAX. QUANTITY PER TOOL FRAME F NC 5120 00..

F NC 9510 00 03	ISO 30	24
F NC 9530 00 03	ISO 40	24
F NC 9540 00 03	ISO 45	18
F NC 9550 00 03	ISO 50	15
F NC 9560 00 03	VDI 30	24
F NC 9570 00 03	VDI 40	18
F NC 9580 00 03	VDI 50	18
F NC 9590 00 03	VDI 60	15
F NC 9720 00 03	MORSE TAPER 2	24
F NC 9730 00 03	MORSE TAPER 3	24

ORD. NO. TOOL HOLDERS

TOOL HOLDER TYPE
MAX. QUANTITY PER TOOL FRAME F NC 5120 00..

F NC 9740 00 03	MORSE TAPER 4	24
F NC 9750 00 03	MORSE TAPER 5	18
F NC 9270 00 03	CAPTO C3	24
F NC 9275 00 03	CAPTO C4	18
F NC 9280 00 03	CAPTO C5	18
F NC 9285 00 03	CAPTO C6	18
F NC 9290 00 03	CAPTO C8	12
F NC 9210 00 03	HSK A32-B40	24
F NC 9220 00 03	HSK A40-B50	24
F NC 9230 00 03	HSK A50-B63	18

ORD. NO. TOOL HOLDERS

TOOL HOLDER TYPE
MAX. QUANTITY PER TOOL FRAME F NC 5120 00..

F NC 9240 00 03	HSK A63-B80	18
F NC 9250 00 03	HSK A80-B100	12
F NC 9260 00 03	HSK A100-B125	12
F NC 9640 00 03	2"	18
F NC 9650 00 03	2" 1/4	15
F NC 9010 00 03	58 mm	27
F NC 9020 00 03	65 mm	24
F NC 9030 00 03	75 mm	21
F NC 9040 00 03	87 mm	18
F NC 9050 00 03	105 mm	15

RAL 7000 F.01 RAL 6011 F.02 RAL 5012 F.04 RAL 7035 F.08

KEY ■



■ Partitioning material see page B57

■ Tool frame in the lowest position



- S = normal extension (87%)
- TT = telescopic full extension (100%)
- All indicated loads are net and refer to evenly distributed weights



LENGTH = 717 mm DEPTH = 597/632 mm (36x27 Eh)

CABINETS SERIES NC-STANDARD F27



RAL 7035 + RAL 5012

CABINET WITH LEAF DOORS

ORD. NO.

F AE 1040 S1 50

including 2 drawers

2 retractable shelves

1 rubber cover with 4 edges

Dimensions mm 717x597x1020 h

Tools excluded

CABINET WITH LEAF DOORS

ORD. NO.

F AE 2040 S1 01

including 4 drawers

2 tool holder frames

1 rubber cover with 3 edges

Dimensions mm 717x597x1020 hTools, tool holders,
partitioning material excluded

RAL 7000

■ INFO

RAL 7000 F.01 RAL 6011 F.02 RAL 5012 F.04 RAL 7035 F.08



www.famispa.com

■ Tool
frame in the
lowest
position

■ Partitioning
material see
page A180

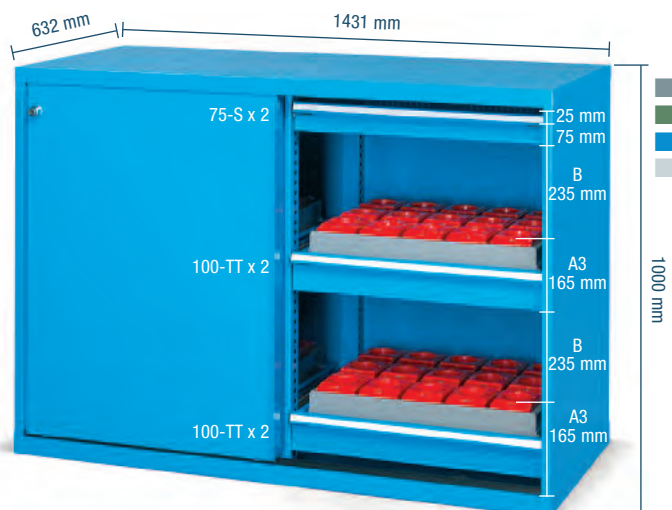
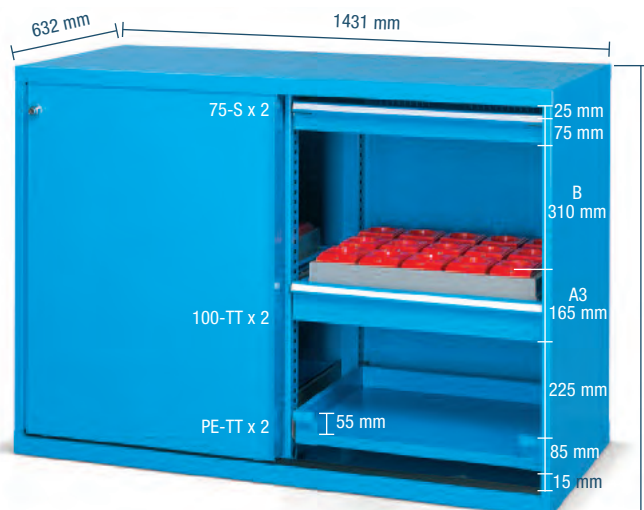

CABINETS SERIES NC-STANDARD F27



ORD. NO.

F AF 1040 15 04

- Including: 2 normal extension drawers ORD. NO. **F FG 1007 00 04**
 - 2 telescopic extension drawers ORD. NO. **F FG 1110 00 04**
 - 2 telescopic retractable shelves ORD. NO. **F FG 8110 00 04**
 - 2 frame 3-rows ORD. NO. **F NC 5120 00 01**, 2 pairs of carriers ORD. NO. **F NC 5630 00 01**
- Dimensions mm 1431x632x1000 h** Tools excluded

THE TOOL FRAME CAN BE ADJUSTED IN 3 DIFFERENT HEIGHTS

Height frame with drawer	Usable height	Max. height of the tool taper
A1 115 mm	B 360 mm	D 93 mm
A2 140 mm	B 335 mm	D 118 mm
A3 165 mm	B 310 mm	D 143 mm

The adjustment pitch of the drawer is 25 mm in height.

ORD. NO.

F AF 1040 16 04

- Including: 2 normal extension drawers ORD. NO. **F FG 1007 00 04**
 - 4 telescopic extension drawers ORD. NO. **F FG 1110 00 04**
 - 4 frames 3-rows ORD. NO. **F NC 5120 00 01**
 - 4 pairs of carriers ORD. NO. **F NC 5630 00 01**
- Dimensions mm 1431x632x1000 h** Tools excluded

THE TOOL FRAME CAN BE ADJUSTED IN 3 DIFFERENT HEIGHTS

Height frame with drawer	Usable height	Max. height of the tool taper
A1 115 mm	B 285 mm	D 93 mm
A2 140 mm	B 260 mm	D 118 mm
A3 165 mm	B 235 mm	D 143 mm

The adjustment pitch of the drawer is 25 mm in height.

Height drawer with frame

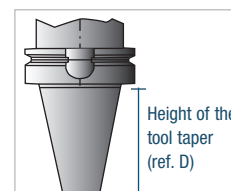
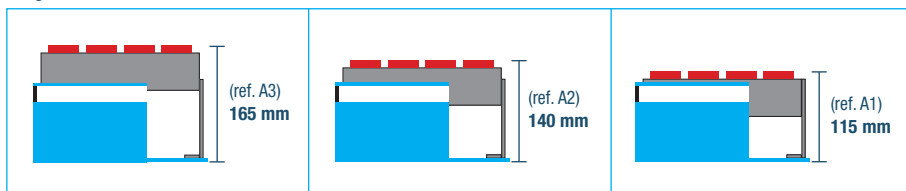

ORD. NO. TOOL HOLDERS

TOOL HOLDER TYPE
MAX. QUANTITY PER TOOL FRAME F NC 5120 00..

F NC 9510 00 03	ISO 30	24
F NC 9530 00 03	ISO 40	24
F NC 9540 00 03	ISO 45	18
F NC 9550 00 03	ISO 50	15
F NC 9560 00 03	VDI 30	24
F NC 9570 00 03	VDI 40	18
F NC 9580 00 03	VDI 50	18
F NC 9590 00 03	VDI 60	15
F NC 9720 00 03	MORSE TAPER 2	24
F NC 9730 00 03	MORSE TAPER 3	24

ORD. NO. TOOL HOLDERS

TOOL HOLDER TYPE
MAX. QUANTITY PER TOOL FRAME F NC 5120 00..

F NC 9740 00 03	MORSE TAPER 4	24
F NC 9750 00 03	MORSE TAPER 5	18
F NC 9270 00 03	CAPTO C3	24
F NC 9275 00 03	CAPTO C4	18
F NC 9280 00 03	CAPTO C5	18
F NC 9285 00 03	CAPTO C6	18
F NC 9290 00 03	CAPTO C8	12
F NC 9210 00 03	HSK A32-B40	24
F NC 9220 00 03	HSK A40-B50	24
F NC 9230 00 03	HSK A50-B63	18

ORD. NO. TOOL HOLDERS

TOOL HOLDER TYPE
MAX. QUANTITY PER TOOL FRAME F NC 5120 00..

F NC 9240 00 03	HSK A63-B80	18
F NC 9250 00 03	HSK A80-B100	12
F NC 9260 00 03	HSK A100-B125	12
F NC 9640 00 03	2"	18
F NC 9650 00 03	2" 1/4	15
F NC 9010 00 03	58 mm	27
F NC 9020 00 03	65 mm	24
F NC 9030 00 03	75 mm	21
F NC 9040 00 03	87 mm	18
F NC 9050 00 03	105 mm	15

RAL 7000 F.01 RAL 6011 F.02 RAL 5012 F.04 RAL 7035 F.08

KEY ■

- S = normal extension (87%)
- TT = telescopic full extension (100%)
- All indicated loads are net and refer to evenly distributed weights



■ Partitioning material see page B57

■ Tool frame in the lowest position



LENGTH = 717 mm DEPTH = 597/632 mm (36x27 Eh)

CABINETS SERIES NC-STANDARD F27



RAL 7035

CABINET WITH SLIDING DOORS**ORD. NO.****F AF 1040 S1 08**including 4 drawers, 2 retractable shelves, 2 tool holder frames,
1 rubber cover with 3 edges**Dimensions mm 1431x632x1020 h**

Tools and tool holders excluded

■ **INFO**

RAL 7000 F.01 RAL 6011 F.02 RAL 5012 F.04 RAL 7035 F.08

www.famispa.com

■ Tool
frame in the
lowest
position

■ Partitioning
material see
page **A180**



CABINETS SERIES NC-STANDARD F27

EMPTY CABINET (FB102)

- 01
- 02
- 04
- 08



ORD. NO. LOAD CAPACITY kg

F AE 1040 00 04 3000

Dimensions mm 717x597x1000 h

Usable height mm 150+725

Cabinet including 2 cylinder locks and 4 keys

ORD. NO.

R CSR 0003 00
Spare lock (for cabinet)

R CSR 0008 00
Spare lock (for door)

R XAE 0001 99
Pair of spare rods (for door)

EMPTY CABINET (FB100)

- 01
- 02
- 04
- 08



ORD. NO. LOAD CAPACITY kg

F AE 2040 00 04 3000

Dimensions mm 717x597x1000 h

Usable height mm 875

Cabinet including cylinder lock and 2 keys

ORD. NO.

R CSR 0008 00
Spare lock (for door)

R XAE 0002 99
Pair of spare rods (for door)

EMPTY CABINET (FD100)

- 01
- 02
- 04
- 08



ORD. NO. LOAD CAPACITY kg

F AF 1040 00 04 1500+1500

Dimensions mm 1431x632x1000 h

Usable height mm 875

Cabinet including cylinder lock and 2 keys

ORD. NO.

R CSR 0012 00
Spare lock (for door)

■ The cabinet must be fixed to the wall or floor.
Further information of set of fixing
see page B48.

NORMAL EXTENSION DRAWERS (S)

ORD. NO.	FRONT HEIGHT mm	LOAD CAPACITY kg	USABLE DIM. mm
F FG 1005 00 04	50	60	600x447x36 h
F FG 1007 00 04	75	80	600x447x61 h
F FG 1010 00 04	100	100	600x447x86 h
F FG 1012 00 04	125	100	600x447x111 h

Normal extension (87%)



- 01
- 02
- 04
- 08

■ Partitioning material see page B57

TELESCOPIC EXTENSION DRAWERS (TT)

ORD. NO.	FRONT HEIGHT mm	LOAD CAPACITY kg	USABLE DIM. mm
F FG 1107 00 04	75	200	600x447x54 h
F FG 1110 00 04	100	200	600x447x79 h
F FG 1112 00 04	125	200	600x447x104 h
F FG 1115 00 04	150	200	600x447x129 h
F FG 1120 00 04	200	200	600x447x179 h
F FG 1125 00 04	250	200	600x447x229 h
F FG 1130 00 04	300	200	600x447x279 h

Telescopic extension (100%)

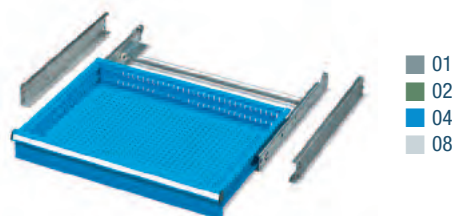

- 01
- 02
- 04
- 08

■ Partitioning material see page B57

NORMAL EXTENSION SHELVES (PE-S)

ORD. NO.	SIDE HEIGHT mm	LOAD CAPACITY kg	USABLE DIM. mm
F FG 8010 00 04	-	100	610x459

Normal extension (87%)



- 01
- 02
- 04
- 08

TELESCOPIC EXTENSION SHELVES (PE-TT)

ORD. NO.	SIDE HEIGHT mm	LOAD CAPACITY kg	USABLE DIM. mm
F FG 8110 00 04	-	200	610x459

Telescopic extension (100%)

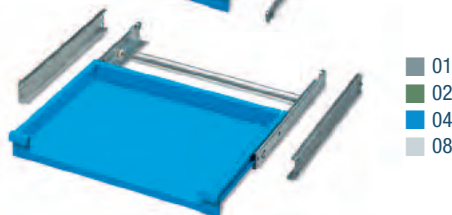

- 01
- 02
- 04
- 08

ADJUSTABLE SHELVES

ORD. NO.	SIDE HEIGHT mm	LOAD CAPACITY kg	USABLE DIM. mm
F SR 1210 01 04	25	150	655x460

Without extension system



- 01
- 02
- 04
- 08

LENGTH = 717 mm DEPTH = 597/632 mm (36x27 Eh)

CABINETS SERIES NC-STANDARD F27

CABINET TO CABINET FIXING

■ The article includes:
4 M8 nuts and bolts.
Suitable for fixing same series cabinets only.

ORD. NO. F AG 9202 00 99

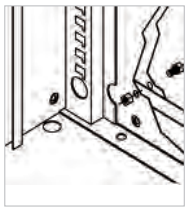

TWO SIDED ADHESIVE TAPE

ORD. NO.

R CMV 0025 00

width 15 mm
length 50 metres



■ 07

PLINTHS

for cabinet F AE 1040 - F AE 2040

ORD. NO.

F RR 0060 00 07

Plinth height 50 mm

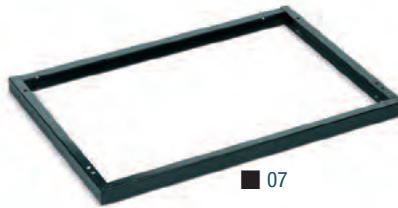

■ 07

PLINTHS

for cabinet F AF 1040

ORD. NO.

F RR 0110 00 07

Plinth height 50 mm



■ 07

PLINTHS FOR TRANSPALLET

for cabinet F AE 1040 - F AE 2040

ORD. NO.

F RR 0305 00 07 Plinth height 100 mm

F RR 0405 00 07 Facing piece



■ 07

PLINTHS FOR TRANSPALLET

for cabinet F AF 1040

ORD. NO.

F RR 0225 00 07

Pair of plinths height 100 mm

F RR 0445 00 07

Facing piece

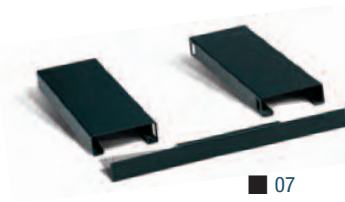

■ 07

PLINTHS FOR FORK LIFT TRUCK

for cabinet F AE 1040 - F AE 2040

ORD. NO.

F RR 0210 00 07

Pair of plinths height 60 mm

F RR 0400 00 07

Facing piece



■ 07

PLINTHS FOR FORK LIFT TRUCK

for cabinet F AF 1040

ORD. NO.

F RR 0220 00 07

Pair of plinths height 60 mm

F RR 0440 00 07

Facing piece

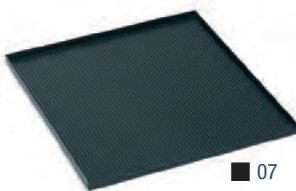

■ 07

TOP SHELF

for cabinet F AE 1040

ORD. NO.

F AG 9000 01 07

oil-resistant rubber cover top with 3 edges

DIMENSIONS mm

717x573x20 H

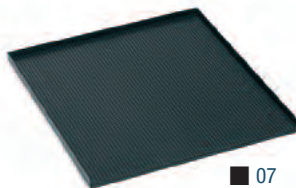

■ 07

TOP SHELF

for cabinet F AE 2040

ORD. NO.

F AE 9003 01 07

oil-resistant rubber cover top with 3 edges

DIMENSIONS mm

717x597x20 h

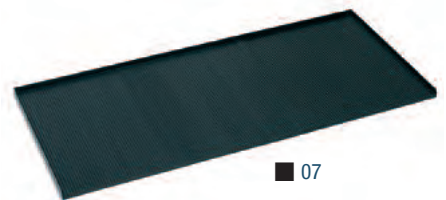

■ 07

TOP SHELF

for cabinet F AF 1040

ORD. NO.

F AF 9000 01 07

oil-resistant rubber cover top with 3 edges

DIMENSIONS mm

1431x630x20 h

CABINETS SERIES NC-STANDARD F27

TOOL HOLDERS FRAME

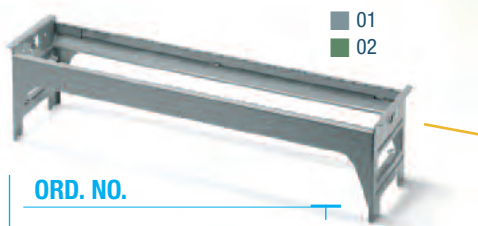

ORD. NO.

F NC 5020 00 01

Horizontal frame load capacity: 50 kg
Dimensions mm 584x140x146 h

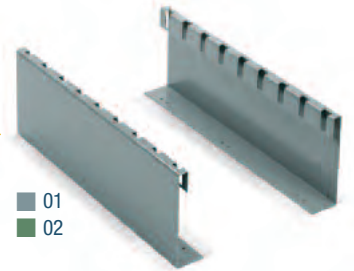

01
02

PAIR OF CARRIERS FOR FRAME

ORD. NO.

F NC 5730 00 01

For frame ORD. NO. F NC 5020 00 ..
Overall dim. mm 442x150 h

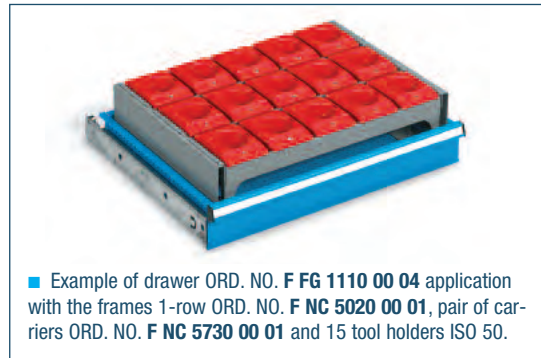

PAIR OF GALVANISED HANDLES

ORD. NO.

F NC 5005 00 99

For frame ORD. NO. F NC 5020 00 ..

TOOL FOR WOODEN INSERT OF MULTIPLEX



ORD. NO.

F NC 5021 00 01

Horizontal frame load capacity: 50 kg
Overall dimensions mm 584x140x146 h



ORD. NO.

F NC 2510 00 00

Wooden insert of multiplex
Overall dimensions mm 525x138x50 h



ALUMINIUM INSERT

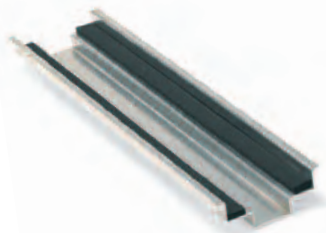

ORD. NO.

F NC 2410 00 00

Aluminium insert with rubber

OVERALL DIMENSIONS mm

525x135x45 h

WOODEN INSERT



ORD. NO.

F NC 2530 00 01

Wooden insert

OVERALL DIMENSIONS mm

600x450x160 h

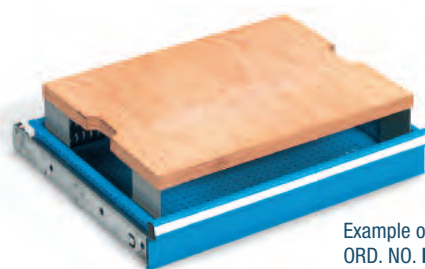

LENGTH = 717 mm DEPTH = 597/632 mm (36x27 Eh)

CABINETS SERIES NC-STANDARD F27

TOOL HOLDER FRAMES 3-ROWS FOR DRAWERS



01
02

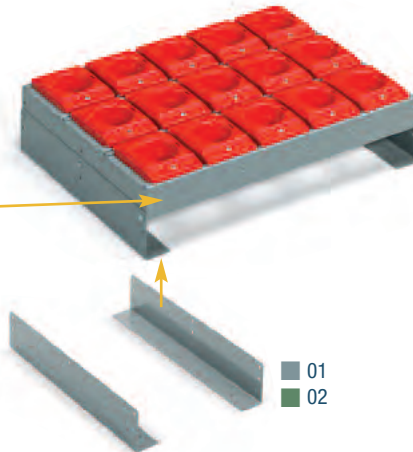

01
02

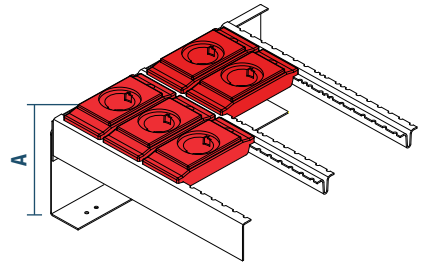
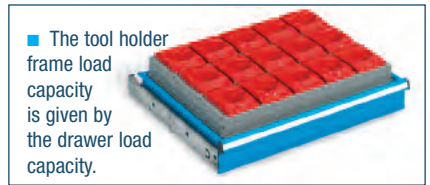

ORD. NO.

F NC 5120 00 01

Overall dim. mm 584x444x69 h

PAIR OF CARRIERS

ORD. NO.

DIMENSIONS mm

FOR HEIGHT TAPER mm REF. A

F NC 5630 00 01

446x86 h

A = 93 / 118 / 143

F NC 5830 00 01

446x136 h

A = 143 / 168 / 193

ORD. NO.
TOOL HOLDERS



TOOL HOLDER
TYPE

MAX. QUANTITY
PER TOOL FRAME
F NC 5020 00 ..

MAX. QUANTITY
PER TOOL FRAME
F NC 5120 00 ..

ORD. NO. TOOL HOLDERS	TOOL HOLDER TYPE	MAX. QUANTITY PER TOOL FRAME F NC 5020 00 ..	MAX. QUANTITY PER TOOL FRAME F NC 5120 00 ..
F NC 9510 00 03	ISO 30	7	24
F NC 9530 00 03	ISO 40	7	24
F NC 9540 00 03	ISO 45	5	18
F NC 9550 00 03	ISO 50	5	15
F NC 9560 00 03	VDI 30	7	24
F NC 9570 00 03	VDI 40	5	18
F NC 9580 00 03	VDI 50	5	18
F NC 9590 00 03	VDI 60	5	15
F NC 9720 00 03	MORSE TAPER 2	7	24
F NC 9730 00 03	MORSE TAPER 3	7	24
F NC 9740 00 03	MORSE TAPER 4	7	24
F NC 9750 00 03	MORSE TAPER 5	5	18
F NC 9270 00 03	CAPTO C3	7	24
F NC 9275 00 03	CAPTO C4	5	18
F NC 9280 00 03	CAPTO C5	5	18

ORD. NO.
TOOL HOLDERS



TOOL HOLDER
TYPE

MAX. QUANTITY
PER TOOL FRAME
F NC 5020 00 ..

MAX. QUANTITY
PER TOOL FRAME
F NC 5120 00 ..

ORD. NO. TOOL HOLDERS	TOOL HOLDER TYPE	MAX. QUANTITY PER TOOL FRAME F NC 5020 00 ..	MAX. QUANTITY PER TOOL FRAME F NC 5120 00 ..
F NC 9285 00 03	CAPTO C6	5	18
F NC 9290 00 03	CAPTO C8	4	12
F NC 9210 00 03	HSK A32-B40	7	24
F NC 9220 00 03	HSK A40-B50	7	24
F NC 9230 00 03	HSK A50-B63	5	18
F NC 9240 00 03	HSK A63-B80	5	18
F NC 9250 00 03	HSK A80-B100	4	12
F NC 9260 00 03	HSK A100-B125	4	12
F NC 9640 00 03	2"	5	18
F NC 9650 00 03	2" 1/4	5	15
F NC 9010 00 03	58 mm	9	27
F NC 9020 00 03	65 mm	8	24
F NC 9030 00 03	75 mm	7	21
F NC 9040 00 03	87 mm	6	18
F NC 9050 00 03	105 mm	5	15

Partitioning material see page A180

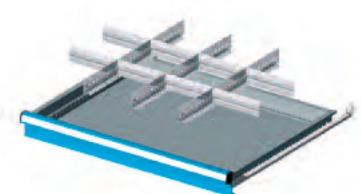
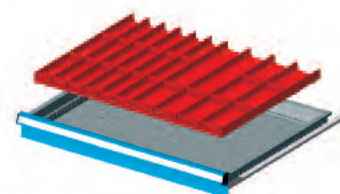
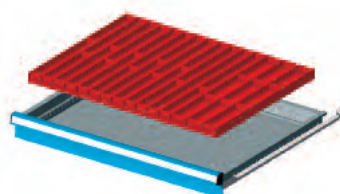
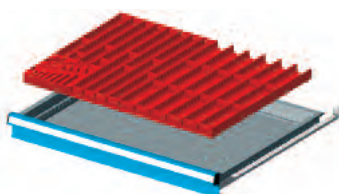

ORD. NO.

FOR FRONT
HEIGHTS

F FH 1005 15 00

50-300

Set including:

5 Troughs	4 grooves
20 Plain partitions	36 mm
6 Troughs	3 grooves
20 Plain partitions	47 mm
1 Allen key tray	150x150 mm

ORD. NO.

FOR FRONT
HEIGHTS

F FH 1005 10 00

50-300

Set including:

9 Troughs	4 grooves
36 Plain partitions	36 mm
3 Troughs	3 grooves
12 Plain partitions	47 mm

ORD. NO.

FOR FRONT
HEIGHTS

F FH 1005 13 00

50-300

Set including:

6 Troughs	3 grooves
18 Plain partitions	47 mm
6 Troughs	2 grooves
12 Plain partitions	73 mm

ORD. NO.

FOR FRONT
HEIGHTS

F FH 1005 03 00

50

F FH 1007 03 00

75

F FH 1010 03 00

100-125

F FH 1015 03 00

150-175

F FH 1020 03 00

200-250

Set including:

3 Slotted partitions	455 mm
8 Plain partitions	149 mm

Partitioning material see page A80 - A81



ORD. NO. F AF 3040 17 08
RAL 7035

ORD. NO. F AE 4058 14 01
RAL 7000

■ The max. height of the tool holder taper which can be inserted in the drawer frame is **143 mm**. For higher tapers, please see page **B69**.

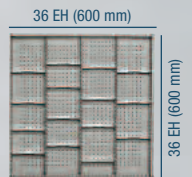
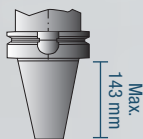

FLOOR FIXING SET



- 2 "HILTI" plugs for concrete floors \geq to classes B25/RBK250/MP_A 25 N/mm²
- Recommended traction of the plug: 2.9 KN
- Plug diameter: \varnothing 6 mm

ORD. NO. F AG 9204 00 99

CABINET WITH SLIDING DOORS

ORD. NO.	DRAWERS
F AF 3040 17 08	4
Including 4 drawers	
2 retractable shelves	
2 tool holder frames	
Dimensions mm 1431x785x1000 h	
Tools and tool holders excluded	

CABINET WITH LEAF DOORS

ORD. NO.	DRAWERS
F AE 4058 14 01	3
Including 3 drawers	
2 retractable shelves	
1 tool holders frame	
Dimensions mm 717x750x1450 h	
Tools and tool holders excluded	

RAL 7000 F.01

RAL 6011 F.02

RAL 5012 F.04

RAL 7035 F.08

SUPPLEMENTARY PARTS ■

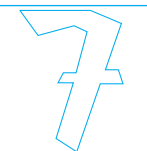

- **Spare key.** Always indicate the number on the cylinder lock of the key to be replaced.
ORD. NO. R CSC 0002 00
- **Master key.** This type of key opens all the 45 and 46 series locks.
ORD. NO. R CSC 0001 00



LENGTH = 717 mm DEPTH = 750/785 mm (36x36 Eh)

CABINETS SERIES NC-STANDARD F36

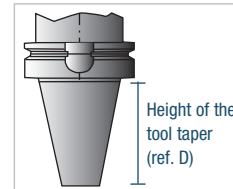
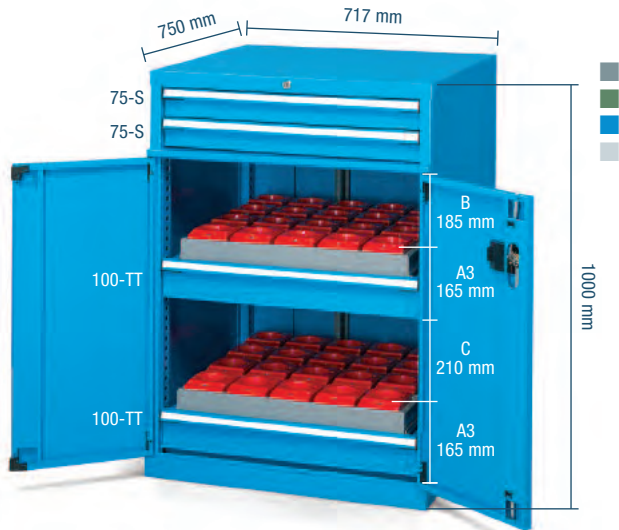

ORD. NO.

F AE 3040 19 04

Including:

- 2 normal extension drawers ORD. NO. **F FG 2007 00 04**
- 2 telescopic extension drawers ORD. NO. **F FG 2110 00 04**
- 2 frames 4-rows ORD. NO. **F NC 5220 00 01**
- 2 pair of carriers ORD. NO. **F NC 5650 00 01**

Dimensions mm 717x750x1000 h

Tools excluded

THE TOOL FRAME CAN BE ADJUSTED IN 3 DIFFERENT HEIGHTS

	Height frame with drawer	Usable height	Max. height of the tool taper
A1	115 mm	B 235 mm	D 93 mm
A2	140 mm	B 210 mm	D 118 mm
A3	165 mm	B 185 mm	D 143 mm
A1	115 mm	C 260 mm	D 93 mm
A2	140 mm	C 235 mm	D 118 mm
A3	165 mm	C 210 mm	D 143 mm

The adjustment pitch of the drawer is 25 mm in height.

Height drawer with frame

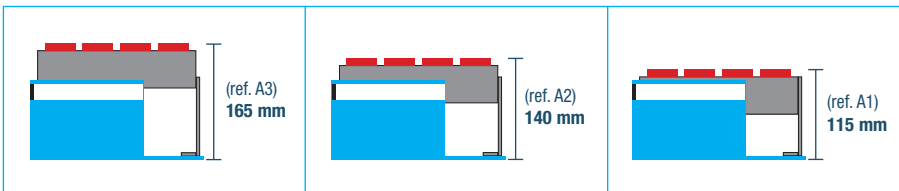

ORD. NO. TOOL HOLDERS

ORD. NO.	TOOL HOLDER TYPE	MAX. QUANTITY PER TOOL FRAME F NC 5220 00 ..
F NC 9510 00 03	ISO 30	32
F NC 9530 00 03	ISO 40	32
F NC 9540 00 03	ISO 45	24
F NC 9550 00 03	ISO 50	20
F NC 9560 00 03	VDI 30	32
F NC 9570 00 03	VDI 40	24
F NC 9580 00 03	VDI 50	24
F NC 9590 00 03	VDI 60	20
F NC 9720 00 03	MORSE TAPER 2	32
F NC 9730 00 03	MORSE TAPER 3	32
F NC 9740 00 03	MORSE TAPER 4	32
F NC 9750 00 03	MORSE TAPER 5	24
F NC 9270 00 03	CAPTO C3	32
F NC 9275 00 03	CAPTO C4	24
F NC 9280 00 03	CAPTO C5	24

ORD. NO. TOOL HOLDERS

ORD. NO.	TOOL HOLDER TYPE	MAX. QUANTITY PER TOOL FRAME F NC 5220 00 ..
F NC 9285 00 03	CAPTO C6	24
F NC 9290 00 03	CAPTO C8	16
F NC 9210 00 03	HSK A32-B40	32
F NC 9220 00 03	HSK A40-B50	32
F NC 9230 00 03	HSK A50-B63	24
F NC 9240 00 03	HSK A63-B80	24
F NC 9250 00 03	HSK A80-B100	16
F NC 9260 00 03	HSK A100-B125	16
F NC 9640 00 03	2"	24
F NC 9650 00 03	2" 1/4	20
F NC 9010 00 03	58 mm	36
F NC 9020 00 03	65 mm	32
F NC 9030 00 03	75 mm	28
F NC 9040 00 03	87 mm	24
F NC 9050 00 03	105 mm	20

KEY

- RAL 7000 F.01
- RAL 6011 F.02
- RAL 5012 F.04
- RAL 7035 F.08



- S = normal extension (87%)
- TT = telescopic full extension (100%)
- All indicated loads are net and refer to evenly distributed weights



Tool frame in the lowest position

Partitioning material see page B69



CABINETS SERIES NC-STANDARD F36

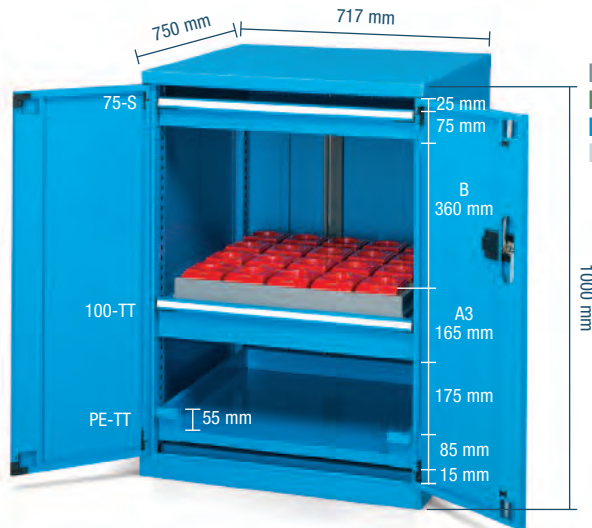

ORD. NO.

F AE 4040 16 04

- Including: 1 normal extension drawer ORD. NO. **F FG 2007 00 04**
 - 1 telescopic extension drawer ORD. NO. **F FG 2110 00 04**
 - 1 telescopic retractable shelf ORD. NO. **F FG 8120 00 04**
 - 1 frame 4-rows ORD. NO. **F NC 5220 00 01**, 1 pair of carriers ORD. NO. **F NC 5650 00 01**
- Dimensions mm 717x750x1000 h Tools excluded

ORD. NO.

F AE 4040 17 04

- Including: 1 normal extension drawer ORD. NO. **F FG 2010 00 04**
 - 2 telescopic extension drawers ORD. NO. **F FG 2110 00 04**
 - 2 frames 4-rows ORD. NO. **F NC 5220 00 01**
 - 2 pairs of carriers ORD. NO. **F NC 5650 00 01**
- Dimensions mm 717x750x1000 h Tools excluded

THE TOOL FRAME CAN BE ADJUSTED IN 3 DIFFERENT HEIGHTS

Height frame with drawer	Usable height	Max. height of the tool taper
A1 115 mm	B 410 mm	D 93 mm
A2 140 mm	B 385 mm	D 118 mm
A3 165 mm	B 360 mm	D 143 mm

The adjustment pitch of the drawer is 25 mm in height.

THE TOOL FRAME CAN BE ADJUSTED IN 3 DIFFERENT HEIGHTS

Height frame with drawer	Usable height	Max. height of the tool taper
A1 115 mm	B 260 mm	D 93 mm
A2 140 mm	B 235 mm	D 118 mm
A3 165 mm	B 210 mm	D 143 mm
A1 115 mm	C 285 mm	D 93 mm
A2 140 mm	C 260 mm	D 118 mm
A3 165 mm	C 235 mm	D 143 mm

The adjustment pitch of the drawer is 25 mm in height.

Height drawer with frame

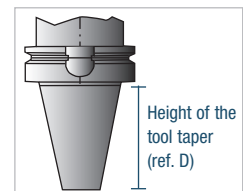
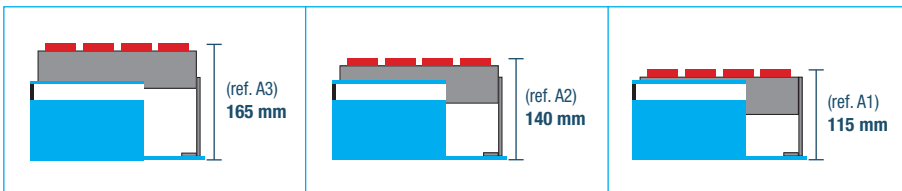

ORD. NO. TOOL HOLDERS

ORD. NO. TOOL HOLDERS	TOOL HOLDER TYPE	MAX. QUANTITY PER TOOL FRAME F NC 5220 00..
F NC 9510 00 03	ISO 30	32
F NC 9530 00 03	ISO 40	32
F NC 9540 00 03	ISO 45	24
F NC 9550 00 03	ISO 50	20
F NC 9560 00 03	VDI 30	32
F NC 9570 00 03	VDI 40	24
F NC 9580 00 03	VDI 50	24
F NC 9590 00 03	VDI 60	20
F NC 9720 00 03	MORSE TAPER 2	32
F NC 9730 00 03	MORSE TAPER 3	32

ORD. NO. TOOL HOLDERS

ORD. NO. TOOL HOLDERS	TOOL HOLDER TYPE	MAX. QUANTITY PER TOOL FRAME F NC 5220 00..
F NC 9740 00 03	MORSE TAPER 4	32
F NC 9750 00 03	MORSE TAPER 5	24
F NC 9270 00 03	CAPTO C3	32
F NC 9275 00 03	CAPTO C4	24
F NC 9280 00 03	CAPTO C5	24
F NC 9285 00 03	CAPTO C6	24
F NC 9290 00 03	CAPTO C8	16
F NC 9210 00 03	HSK A32-B40	32
F NC 9220 00 03	HSK A40-B50	32
F NC 9230 00 03	HSK A50-B63	24

ORD. NO. TOOL HOLDERS

ORD. NO. TOOL HOLDERS	TOOL HOLDER TYPE	MAX. QUANTITY PER TOOL FRAME F NC 5220 00..
F NC 9240 00 03	HSK A63-B80	24
F NC 9250 00 03	HSK A80-B100	16
F NC 9260 00 03	HSK A100-B125	16
F NC 9640 00 03	2"	24
F NC 9650 00 03	2" 1/4	20
F NC 9010 00 03	58 mm	36
F NC 9020 00 03	65 mm	32
F NC 9030 00 03	75 mm	28
F NC 9040 00 03	87 mm	24
F NC 9050 00 03	105 mm	20

RAL 7000 F.01 RAL 6011 F.02 RAL 5012 F.04 RAL 7035 F.08

KEY ■

7

- Partitioning material see page B69
- Tool frame in the lowest position

- S = normal extension (87%)
- TT = telescopic full extension (100%)
- All indicated loads are net and refer to evenly distributed weights

LENGTH = 717 mm DEPTH = 750/785 mm (36x36 Eh)

CABINETS SERIES NC-STANDARD F36



CABINET WITH LEAF DOORS

ORD. NO.

F AE 3040 S1 50

including 4 drawers

2 tool holder frames

1 MDF top shelf

Dimensions mm 717x750x1030 h

Tools and tool holders excluded

■ RAL 7035 + ■ RAL 5012

CABINET WITH LEAF DOORS

ORD. NO.

F AE 4058 S1 01

Including 3 drawers

2 retractable shelves

1 tool holders frame

1 rubber cover with 3 edges

Dimensions mm 717x750x1470 h

Tools and tool holders excluded



■ RAL 7000

■ INFO

RAL 7000 F.01 RAL 6011 F.02 RAL 5012 F.04 RAL 7035 F.08

www.famispa.com■ Tool
frame in the
lowest
position■ Partitioning
material see
page **A180**

CABINETS SERIES NC-STANDARD F36

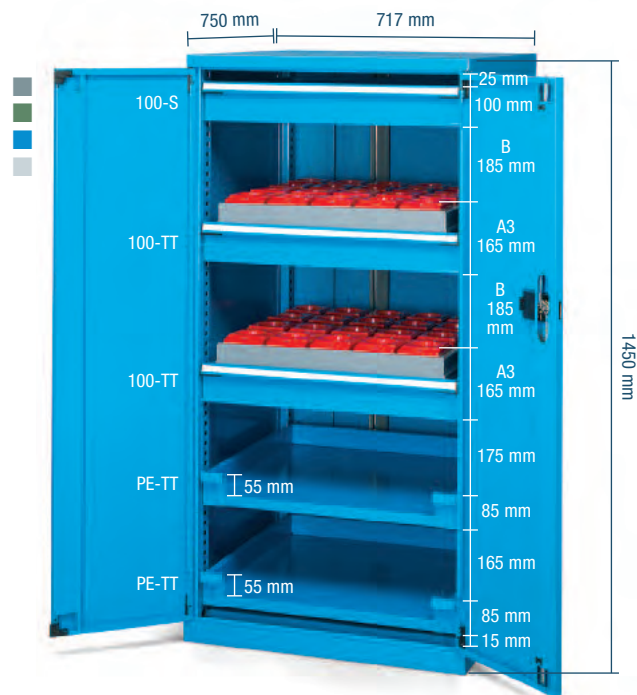

ORD. NO.

F AE 4058 13 04

- Including: 1 normal extension drawer ORD. NO. **F FG 2010 00 04**
- 2 telescopic extension drawers ORD. NO. **F FG 2110 00 04**
- 2 frames 4-rows ORD. NO. **F NC 5220 00 01**, 2 pairs of carriers ORD. NO. **F NC 5650 00 01**
- 2 telescopic retractable shelves ORD. NO. **F FG 8120 00 04**

Dimensions mm 717x750x1450 h Tools excluded

THE TOOL FRAME CAN BE ADJUSTED IN 3 DIFFERENT HEIGHTS

Height frame with drawer	Usable height	Max. height of the tool taper
A1 115 mm	B 235 mm	D 93 mm
A2 140 mm	B 210 mm	D 118 mm
A3 165 mm	B 185 mm	D 143 mm

The adjustment pitch of the drawer is 25 mm in height.

ORD. NO.

F AE 4058 14 04

- Including: 2 normal extension drawers ORD. NO. **F FG 2010 00 04**
- 1 telescopic extension drawer ORD. NO. **F FG 2110 00 04**
- 1 frames 4-rows ORD. NO. **F NC 5220 00 01**, 1 pair of carriers ORD. NO. **F NC 5650 00 01**
- 2 telescopic retractable shelves ORD. NO. **F FG 8120 00 04**

Dimensions mm 717x750x1450 h Tools excluded

THE TOOL FRAME CAN BE ADJUSTED IN 3 DIFFERENT HEIGHTS

Height frame with drawer	Usable height	Max. height of the tool taper
A1 115 mm	B 460 mm	D 93 mm
A2 140 mm	B 435 mm	D 118 mm
A3 165 mm	B 410 mm	D 143 mm

The adjustment pitch of the drawer is 25 mm in height.

Height drawer with frame

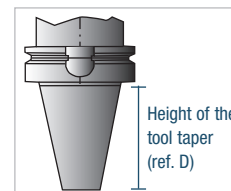
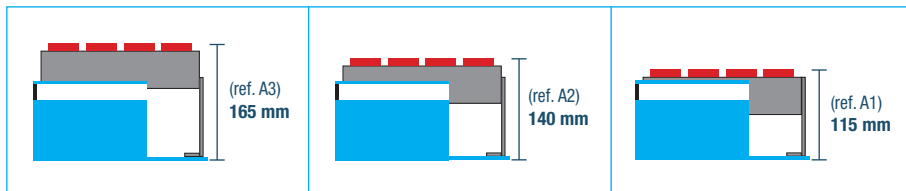

RAL 7000 F.01 RAL 6011 F.02 RAL 5012 F.04 RAL 7035 F.08

KEY ■

- **S** = normal extension (87%)
- **TT** = telescopic full extension (100%)
- All indicated loads are net and refer to evenly distributed weights

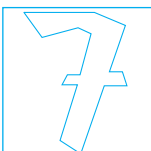

■ Partitioning material see page **B69**

■ Tool frame in the lowest position

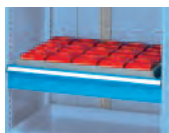

LENGTH = 717 mm DEPTH = 750/785 mm (36x36 Eh)

CABINETS SERIES NC-STANDARD F36



ORD. NO.

F AE 4058 15 04

Including:

4 telescopic extension drawers ORD. NO. **F FG 2110 00 04**

4 frames 4-rows ORD. NO. **F NC 5220 00 01**

4 pairs of carriers ORD. NO. **F NC 5650 00 01**

Dimensions mm **717x750x1450 h**

Tools excluded

ORD. NO.

F AE 4058 16 04

Including:

3 telescopic extension drawers ORD. NO. **F FG 2110 00 04**

3 frames 4-rows ORD. NO. **F NC 5220 00 01**

3 pairs of carriers ORD. NO. **F NC 5650 00 01**

Dimensions mm **717x750x1450 h**

Tools excluded

THE TOOL FRAME CAN BE ADJUSTED IN 3 DIFFERENT HEIGHTS

Height frame with drawer	Usable height	Max. height of the tool taper
A1 115 mm	B 210 mm	D 93 mm
A2 140 mm	B 185 mm	D 118 mm
A3 165 mm	B 160 mm	D 143 mm
A1 115 mm	C 235 mm	D 93 mm
A2 140 mm	C 210 mm	D 118 mm
A3 165 mm	C 185 mm	D 143 mm

The adjustment pitch of the drawer is 25 mm in height.

THE TOOL FRAME CAN BE ADJUSTED IN 3 DIFFERENT HEIGHTS

Height frame with drawer	Usable height	Max. height of the tool taper
A1 115 mm	B 335 mm	D 93 mm
A2 140 mm	B 310 mm	D 118 mm
A3 165 mm	B 285 mm	D 143 mm

The adjustment pitch of the drawer is 25 mm in height.

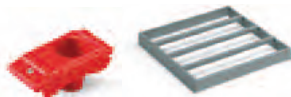

ORD. NO. TOOL HOLDERS

TOOL HOLDER TYPE
MAX. QUANTITY PER TOOL FRAME F NC 5220 00..

F NC 9510 00 03	ISO 30	32
F NC 9530 00 03	ISO 40	32
F NC 9540 00 03	ISO 45	24
F NC 9550 00 03	ISO 50	20
F NC 9560 00 03	VDI 30	32
F NC 9570 00 03	VDI 40	24
F NC 9580 00 03	VDI 50	24
F NC 9590 00 03	VDI 60	20
F NC 9720 00 03	MORSE TAPER 2	32
F NC 9730 00 03	MORSE TAPER 3	32

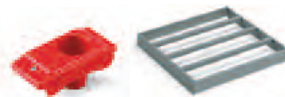

ORD. NO. TOOL HOLDERS

TOOL HOLDER TYPE
MAX. QUANTITY PER TOOL FRAME F NC 5220 00..

F NC 9740 00 03	MORSE TAPER 4	32
F NC 9750 00 03	MORSE TAPER 5	24
F NC 9270 00 03	CAPTO C3	32
F NC 9275 00 03	CAPTO C4	24
F NC 9280 00 03	CAPTO C5	24
F NC 9285 00 03	CAPTO C6	24
F NC 9290 00 03	CAPTO C8	16
F NC 9210 00 03	HSK A32-B40	32
F NC 9220 00 03	HSK A40-B50	32
F NC 9230 00 03	HSK A50-B63	24

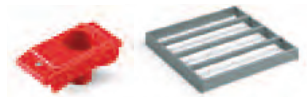

ORD. NO. TOOL HOLDERS

TOOL HOLDER TYPE
MAX. QUANTITY PER TOOL FRAME F NC 5220 00..

F NC 9240 00 03	HSK A63-B80	24
F NC 9250 00 03	HSK A80-B100	16
F NC 9260 00 03	HSK A100-B125	16
F NC 9640 00 03	2"	24
F NC 9650 00 03	2 1/4"	20
F NC 9010 00 03	58 mm	36
F NC 9020 00 03	65 mm	32
F NC 9030 00 03	75 mm	28
F NC 9040 00 03	87 mm	24
F NC 9050 00 03	105 mm	20

KEY

RAL 7000 F.01 RAL 6011 F.02 RAL 5012 F.04 RAL 7035 F.08



- **S** = normal extension (87%)
- **TT** = telescopic full extension (100%)
- All indicated loads are net and refer to evenly distributed weights



■ Tool frame in the lowest position

■ Partitioning material see page **B69**

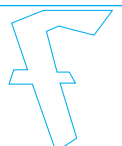

LENGTH = 717 mm DEPTH = 750/785 mm (36x36 Eh)

CABINETS SERIES NC-STANDARD F36

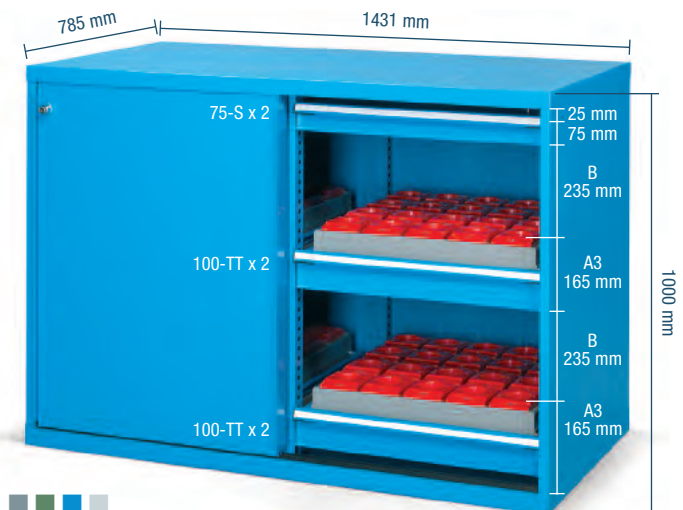
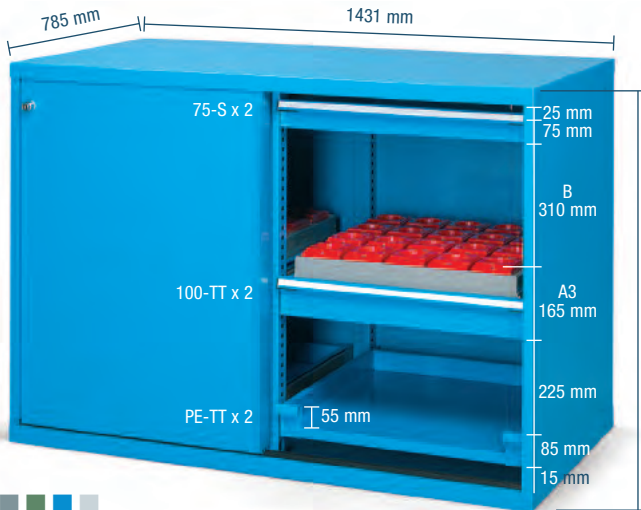

ORD. NO.

F AF 3040 17 04

Including: 2 normal extension drawers ORD. NO. **F FG 2007 00 04**
 2 telescopic extension drawers ORD. NO. **F FG 2110 00 04**
 2 telescopic retractable shelves ORD. NO. **F FG 8120 00 04**
 2 frames 4-rows ORD. NO. **F NC 5220 00 01**, 2 pairs of carriers ORD. NO. **F NC 5650 00 01**
Dimensions mm 1431x785x1000 h Tools excluded

ORD. NO.

F AF 3040 18 04

Including: 2 normal extension drawers ORD. NO. **F FG 2007 00 04**
 4 telescopic extension drawers ORD. NO. **F FG 2110 00 04**
 4 frames 4-rows ORD. NO. **F NC 5220 00 01**
 4 pairs of carriers ORD. NO. **F NC 5650 00 01**
Dimensions mm 1431x785x1000 h Tools excluded

THE TOOL FRAME CAN BE ADJUSTED IN 3 DIFFERENT HEIGHTS

Height frame with drawer	Usable height	Max. height of the tool taper
A1 115 mm	B 360 mm	D 93 mm
A2 140 mm	B 335 mm	D 118 mm
A3 165 mm	B 310 mm	D 143 mm

The adjustment pitch of the drawer is 25 mm in height.

THE TOOL FRAME CAN BE ADJUSTED IN 3 DIFFERENT HEIGHTS

Height frame with drawer	Usable height	Max. height of the tool taper
A1 115 mm	B 285 mm	D 93 mm
A2 140 mm	B 260 mm	D 118 mm
A3 165 mm	B 235 mm	D 143 mm

The adjustment pitch of the drawer is 25 mm in height.

Height drawer with frame

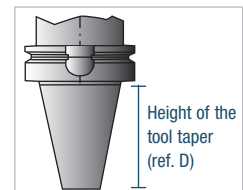
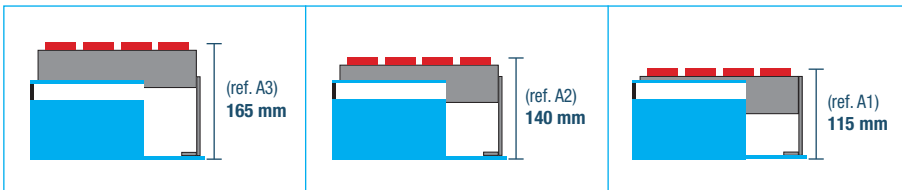

ORD. NO. TOOL HOLDERS

ORD. NO.	TOOL HOLDER TYPE	MAX. QUANTITY PER TOOL FRAME F NC 5220 00..
F NC 9510 00 03	ISO 30	32
F NC 9530 00 03	ISO 40	32
F NC 9540 00 03	ISO 45	24
F NC 9550 00 03	ISO 50	20
F NC 9560 00 03	VDI 30	32
F NC 9570 00 03	VDI 40	24
F NC 9580 00 03	VDI 50	24
F NC 9590 00 03	VDI 60	20
F NC 9720 00 03	MORSE TAPER 2	32
F NC 9730 00 03	MORSE TAPER 3	32

ORD. NO. TOOL HOLDERS

ORD. NO.	TOOL HOLDER TYPE	MAX. QUANTITY PER TOOL FRAME F NC 5220 00..
F NC 9740 00 03	MORSE TAPER 4	32
F NC 9750 00 03	MORSE TAPER 5	24
F NC 9270 00 03	CAPTO C3	32
F NC 9275 00 03	CAPTO C4	24
F NC 9280 00 03	CAPTO C5	24
F NC 9285 00 03	CAPTO C6	24
F NC 9290 00 03	CAPTO C8	16
F NC 9210 00 03	HSK A32-B40	32
F NC 9220 00 03	HSK A40-B50	32
F NC 9230 00 03	HSK A50-B63	24

ORD. NO. TOOL HOLDERS

ORD. NO.	TOOL HOLDER TYPE	MAX. QUANTITY PER TOOL FRAME F NC 5220 00..
F NC 9240 00 03	HSK A63-B80	24
F NC 9250 00 03	HSK A80-B100	16
F NC 9260 00 03	HSK A100-B125	16
F NC 9640 00 03	2"	24
F NC 9650 00 03	2" 1/4	20
F NC 9010 00 03	58 mm	36
F NC 9020 00 03	65 mm	32
F NC 9030 00 03	75 mm	28
F NC 9040 00 03	87 mm	24
F NC 9050 00 03	105 mm	20

RAL 7000 F.01 RAL 6011 F.02 RAL 5012 F.04 RAL 7035 F.08

KEY ■

- **S** = normal extension (87%)
- **TT** = telescopic full extension (100%)
- All indicated loads are net and refer to evenly distributed weights



■ Partitioning material see page **B69**

■ Tool frame in the lowest position

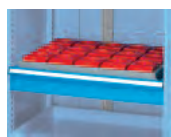

LENGTH = 717 mm DEPTH = 750/785 mm (36x36 Eh)

CABINETS SERIES NC-STANDARD F36

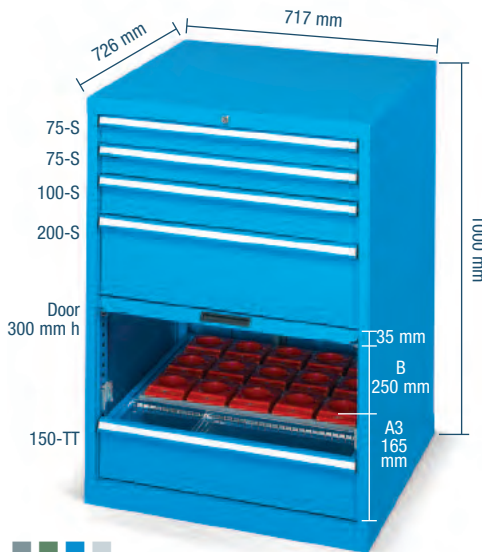

ORD. NO. F AG 2040 28 04

Including: 1 flap door ORD. NO. **F AG 9530 00 04**,
 1 telescopic extension drawer ORD. NO. **F FG 2115 00 04**,
 2 normal extension drawers ORD. NO. **F FG 2007 00 04**,
 1 normal extension drawer ORD. NO. **F FG 2010 00 04**,
 1 normal extension drawer ORD. NO. **F FG 2020 00 04**, 1 frame 3-rows ORD. NO. **F NC 5120 00 01**,
 1 pair of carriers ORD. NO. **F NC 5630 00 01**, 1 slotted partition ORD. NO. **F HA 1440 00 99**
 1 plain partition ORD. NO. **F HA 3440 00 00**

Dimensions mm 717x726x1000 h

Tools excluded

THE TOOL FRAME CAN BE ADJUSTED IN 3 DIFFERENT HEIGHTS

Height frame	Usable height	Max. height of the tool taper
A1 115 mm	B 300 mm	D 93 mm
A2 140 mm	B 275 mm	D 118 mm
A3 165 mm	B 250 mm	D 143 mm

The adjustment pitch of the drawer is 25 mm in height.

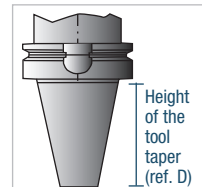

■ Cabinet ORD. NO. **F AG 2040 28 04** with closed flap door

- Frame 3-rows and carriers see page **B57**.
- Example of the open drawer with frame 3-rows, slotted partitions and plain partitions.

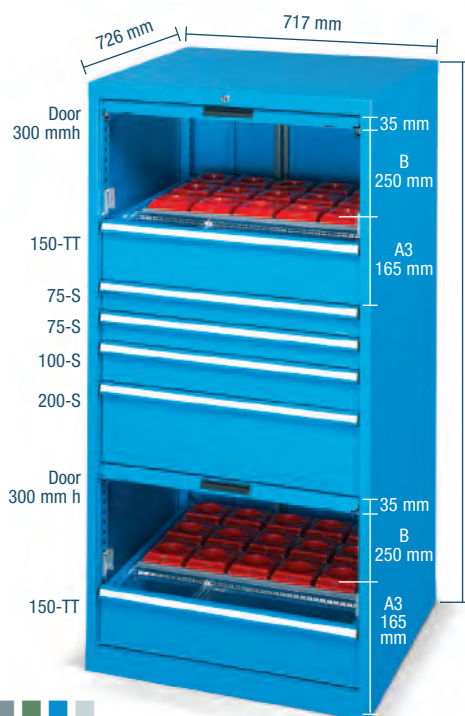

- The door can be closed by the edge of the lower drawer handle (ref. Y)

ORD. NO. F AG 2058 12 04

Including: 2 flap doors ORD. NO. **F AG 9530 00 04**,
 2 telescopic extension drawers ORD. NO. **F FG 2115 00 04**,
 2 normal extension drawers ORD. NO. **F FG 2007 00 04**,
 1 normal extension drawer ORD. NO. **F FG 2010 00 04**,
 1 normal extension drawer ORD. NO. **F FG 2020 00 04**, 2 frames 3-rows ORD. NO. **F NC 5120 00 01**,
 2 pairs of carriers ORD. NO. **F NC 5630 00 01**, 2 slotted partitions ORD. NO. **F HA 1440 00 99**,
 2 plain partitions ORD. NO. **F HA 3440 00 00**

Dimensions mm 717x726x1450 h

Tools excluded

THE TOOL FRAME CAN BE ADJUSTED IN 3 DIFFERENT HEIGHTS

Height frame	Usable height	Max. height of the tool taper
A1 115 mm	B 300 mm	D 93 mm
A2 140 mm	B 275 mm	D 118 mm
A3 165 mm	B 250 mm	D 143 mm

The adjustment pitch of the drawer is 25 mm in height.

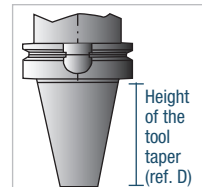

ORD. NO. TOOL HOLDERS	TOOL HOLDER TYPE	MAX. QUANTITY PER TOOL FRAME F NC 5120 00..
F NC 9510 00 03	ISO 30	24
F NC 9530 00 03	ISO 40	24
F NC 9540 00 03	ISO 45	18
F NC 9550 00 03	ISO 50	15
F NC 9560 00 03	VDI 30	24
F NC 9570 00 03	VDI 40	18
F NC 9580 00 03	VDI 50	18
F NC 9590 00 03	VDI 60	15
F NC 9720 00 03	MORSE TAPER 2	24
F NC 9730 00 03	MORSE TAPER 3	24



ORD. NO. TOOL HOLDERS	TOOL HOLDER TYPE	MAX. QUANTITY PER TOOL FRAME F NC 5120 00..
F NC 9740 00 03	MORSE TAPER 4	24
F NC 9750 00 03	MORSE TAPER 5	18
F NC 9270 00 03	CAPTO C3	24
F NC 9275 00 03	CAPTO C4	18
F NC 9280 00 03	CAPTO C5	18
F NC 9285 00 03	CAPTO C6	18
F NC 9290 00 03	CAPTO C8	12
F NC 9210 00 03	HSK A32-B40	24
F NC 9220 00 03	HSK A40-B50	24
F NC 9230 00 03	HSK A50-B63	18

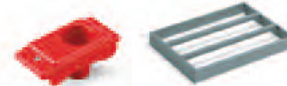

ORD. NO. TOOL HOLDERS	TOOL HOLDER TYPE	MAX. QUANTITY PER TOOL FRAME F NC 5120 00..
F NC 9240 00 03	HSK A63-B80	18
F NC 9250 00 03	HSK A80-B100	12
F NC 9260 00 03	HSK A100-B125	12
F NC 9640 00 03	2"	18
F NC 9650 00 03	2" 1/4	15
F NC 9010 00 03	58 mm	27
F NC 9020 00 03	65 mm	24
F NC 9030 00 03	75 mm	21
F NC 9040 00 03	87 mm	18
F NC 9050 00 03	105 mm	15

CABINETS SERIES NC-STANDARD F36

EMPTY CABINET (FA100)



ORD. NO.	LOAD CAPACITY kg
F AE 3040 00 04	3000
Dimensions mm 717x750x1000 h	
Usable height mm 150+725	
Cabinet including 2 cylinder locks and 4 keys	

ORD. NO.
R CSR 0003 00 Spare lock (for cabinet)
R CSR 0008 00 Spare lock (for door)
R XAE 0001 99 Pair of spare rods (for door)

EMPTY CABINET (F100 - F145)



ORD. NO.	LOAD CAPACITY kg
F AE 4040 00 04	3000
Dimensions mm 717x750x1000 h	
Usable height mm 875	
F AE 4058 00 04	3000
Dimensions mm 717x750x1450 h	
Usable height mm 1325	
Cabinet including cylinder lock and 2 keys	

ORD. NO.
R CSR 0008 00 Spare lock (for door)
R XAE 0002 99 Pair of spare rods (for door) cabinet F AE 4040
R XAE 0003 99 Pair of spare rods (for door) cabinet F AE 4058

EMPTY CABINET (FC100)



ORD. NO.	LOAD CAPACITY kg
F AF 3040 00 04	1500+1500
Dimensions mm 1431x785x1000 h	
Usable height mm 875	
Cabinet including cylinder lock and 2 keys	

ORD. NO.
R CSR 0012 00 Spare lock (for door)

■ The cabinet must be fixed to the wall or floor. Further information of set of fixing see page B48.

NORMAL EXTENSION DRAWERS (S)

ORD. NO.	FRONT HEIGHT mm	LOAD CAPACITY kg	USABLE DIM. mm
F FG 2005 00 04	50	60	600x600x36 h
F FG 2007 00 04	75	80	600x600x61 h
F FG 2010 00 04	100	100	600x600x86 h
F FG 2012 00 04	125	100	600x600x111 h
F FG 2015 00 04	150	100	600x600x136 h
F FG 2017 00 04	175	100	600x600x161 h
F FG 2020 00 04	200	100	600x600x186 h
F FG 2030 00 04	300	100	600x600x286 h

Normal extension (87%)



■ Partitioning material see page B69

TELESCOPIC EXTENSION DRAWERS (TT)

ORD. NO.	FRONT HEIGHT mm	LOAD CAPACITY kg	USABLE DIM. mm
F FG 2107 00 04	75	200	600x600x54 h
F FG 2110 00 04	100	200	600x600x79 h
F FG 2112 00 04	125	200	600x600x104 h
F FG 2115 00 04	150	200	600x600x129 h
F FG 2117 00 04	175	200	600x600x154 h
F FG 2120 00 04	200	200	600x600x179 h
F FG 2125 00 04	250	200	600x600x229 h
F FG 2130 00 04	300	200	600x600x279 h
F FG 2140 00 04	400	200	600x600x379 h

Telescopic extension (100%)

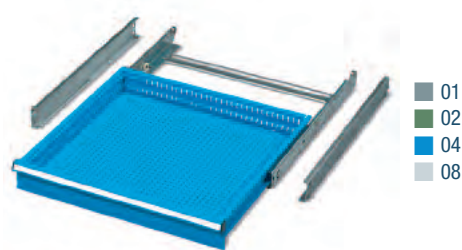

■ Partitioning material see page B69

NORMAL EXTENSION SHELVES (PE-S)

ORD. NO.	SIDE HEIGHT mm	LOAD CAPACITY kg	USABLE DIM. mm
F FG 8020 00 04	-	100	610x610

Normal extension (87%)



LENGTH = 717 mm DEPTH = 750/785 mm (36x36 Eh)

CABINETS SERIES NC-STANDARD F36

TELESCOPIC EXTENSION SHELVES (PE-TT)

ORD. NO.	SIDE HEIGHT mm	LOAD CAPACITY kg	USABLE DIM. mm
F FG 8120 00 04	-	200	610x610

Telescopic extension (100%)



ADJUSTABLE SHELVES

ORD. NO.	SIDE HEIGHT mm	LOAD CAPACITY kg	USABLE DIMENSIONS mm
F SR 1260 01 04	25	150	618x618

Without extension



CABINET TO CABINET FIXING

■ The article includes:
4 M8 nuts and bolts.
Suitable for fixing same series cabinets only.

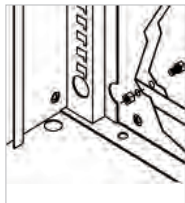

ORD. NO. F AG 9202 00 99

TWO SIDED ADHESIVE TAPE

ORD. NO.

R CMV 0025 00

width 15 mm
length 50 metres



■ 07

PLINTHS

for cabinet F AE 3040 - F AE 4040 - F AE 4058

ORD. NO.

F RR 0080 00 07

Plinth height 50 mm

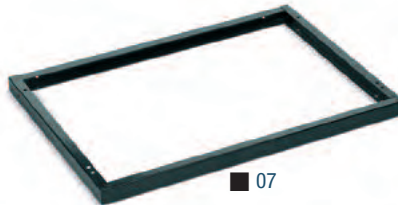

■ 07

PLINTHS

for cabinet F AF 3040

ORD. NO.

F RR 0145 00 07

Plinth height 50 mm

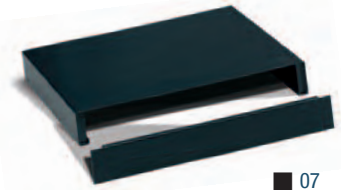

■ 07

PLINTHS FOR TRANSPALLET

for cabinet F AE 3040 - F AE 4040 - F AE 4058

ORD. NO.

F RR 0315 00 07 Plinth height 100 mm

F RR 0405 00 07 Facing piece



■ 07

PLINTHS FOR TRANSPALLET

for cabinet F AF 3040

ORD. NO.

F RR 0255 00 07 Pair of plinths height 100 mm

F RR 0445 00 07 Facing piece



■ 07

PLINTHS FOR FORK LIFT TRUCK

for cabinet F AE 3040 - F AE 4040 - F AE 4058

ORD. NO.

F RR 0240 00 07 Pair of plinths height 60 mm

F RR 0400 00 07 Facing piece

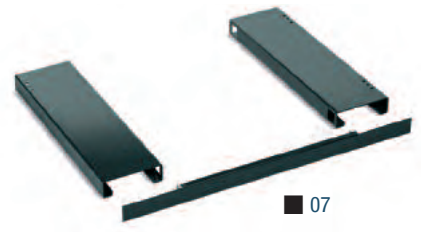

■ 07

PLINTHS FOR FORK LIFT TRUCK

for cabinet F AF 3040

ORD. NO.

F RR 0250 00 07 Pair of plinths height 60 mm

F RR 0440 00 07 Facing piece

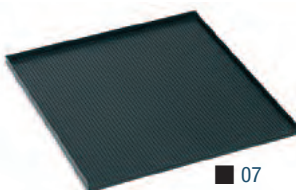

■ 07

TOP SHELF

for cabinet F AE 3040

ORD. NO.

DIMENSIONS mm

F AG 9003 01 07 717x726x20 h

oil-resistant rubber cover top with 3 edges

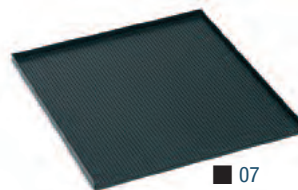

■ 07

TOP SHELF

for cabinet F AE 4040 - F AE 4058

ORD. NO.

DIMENSIONS mm

F AE 9009 01 07 717x750x20 h

oil-resistant rubber cover top with 3 edges



■ 07

TOP SHELF

for cabinet F AF 3040

ORD. NO.

DIMENSIONS mm

F AF 9006 01 07 1431x785x20 h

oil-resistant rubber cover top with 3 edges

CABINETS SERIES NC-STANDARD F36

TOOL HOLDERS FRAME



ORD. NO.

F NC 5020 00 01

Horizontal frame load capacity: 50 kg

Dimensions mm 584x140x146 h

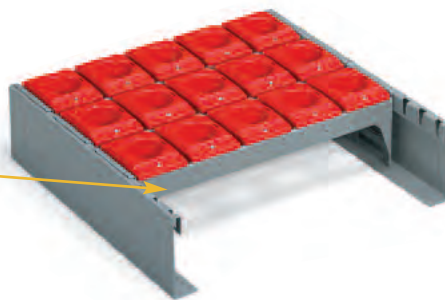

PAIR OF CARRIERS FOR FRAME

ORD. NO.

F NC 5750 00 01

For frame ORD. NO. F NC 5020 00 ..

Overall dim. mm 592x150 h

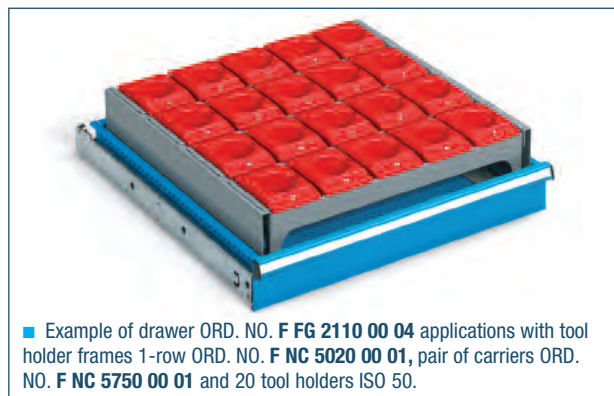

■ Example of drawer ORD. NO. F FG 2110 00 04 applications with tool holder frames 1-row ORD. NO. F NC 5020 00 01, pair of carriers ORD. NO. F NC 5750 00 01 and 20 tool holders ISO 50.



PAIR OF GALVANISED HANDLES

ORD. NO.

F NC 5005 00 99

For frame ORD. NO. F NC 5020 00 ..

TOOL FOR WOODEN INSERT OF MULTIPLEX



ORD. NO.

F NC 5021 00 01

Horizontal frame load capacity: 50 kg

Overall dimensions mm 584x140x146 h



ORD. NO.

F NC 2510 00 00

Wooden insert of multiplex

Overall dimensions mm 525x138x50 h



Example of tool holder frame ORD. NO. F NC 5021 00 .. with wooden insert

ALUMINIUM INSERT

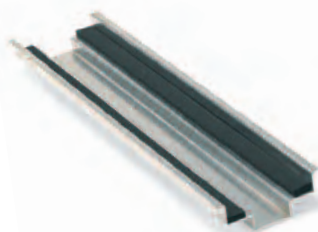

ORD. NO.

F NC 2410 00 00

Aluminium insert with rubber

OVERALL DIMENSIONS mm

525x135x45 h



Example of tool holder frame ORD. NO. F NC 5020 00 .. with aluminium support

WOODEN INSERTS



ORD. NO.

F NC 2550 00 01

Wooden insert

OVERALL DIMENSIONS mm

600x600x160 h

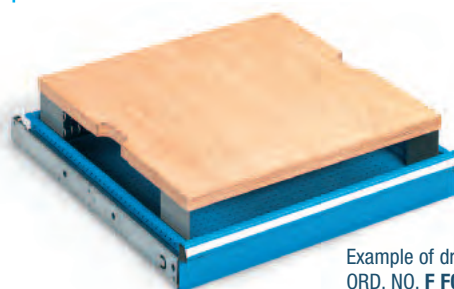

Example of drawer ORD. NO. F FG 2110 00 04 with wooden insert

LENGTH = 717 mm DEPTH = 750/785 mm (36x36 Eh)

CABINETS SERIES NC-STANDARD F36

TOOL HOLDER FRAMES 4-ROWS FOR DRAWERS

- 01
- 02

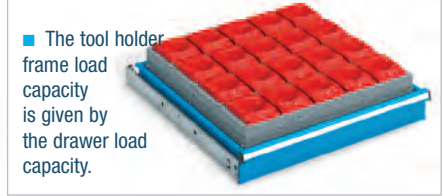
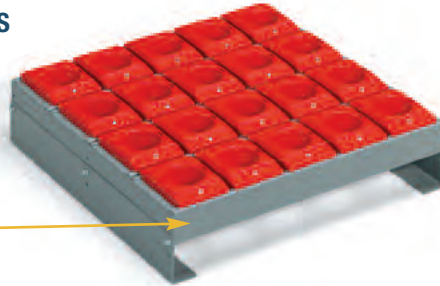
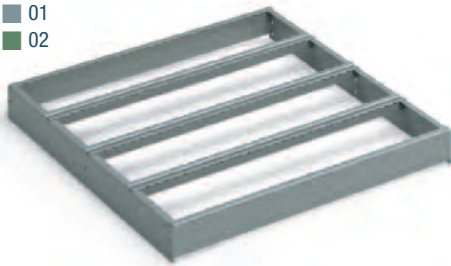

The tool holder frame load capacity is given by the drawer load capacity.

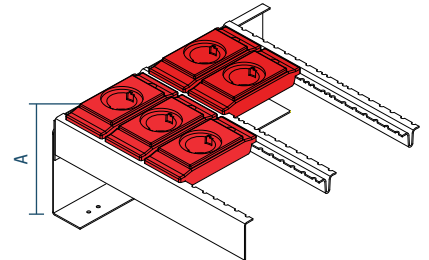

ORD. NO.

F NC 5220 00 01

Overall dim. mm 584x592x69 h

PAIR OF CARRIERS

ORD. NO.

DIMENSIONS mm

FOR HEIGHT TAPER mm REF. A

F NC 5650 00 01

594x86 h

A = 93 / 118 / 143

F NC 5840 00 01

594x136 h

A = 143 / 168 / 193

ORD. NO. TOOL HOLDERS



TOOL HOLDER TYPE

MAX. QUANTITY PER TOOL FRAME F NC 5020 00 ..

MAX. QUANTITY PER TOOL FRAME F NC 5220 00 ..

F NC 9510 00 03	ISO 30	7	32
F NC 9530 00 03	ISO 40	7	32
F NC 9540 00 03	ISO 45	5	24
F NC 9550 00 03	ISO 50	5	20
F NC 9560 00 03	VDI 30	7	32
F NC 9570 00 03	VDI 40	5	24
F NC 9580 00 03	VDI 50	5	24
F NC 9590 00 03	VDI 60	5	20
F NC 9720 00 03	MORSE TAPER 2	7	32
F NC 9730 00 03	MORSE TAPER 3	7	32
F NC 9740 00 03	MORSE TAPER 4	7	32
F NC 9750 00 03	MORSE TAPER 5	5	24
F NC 9270 00 03	CAPTO C3	7	32
F NC 9275 00 03	CAPTO C4	5	24
F NC 9280 00 03	CAPTO C5	5	24

ORD. NO. TOOL HOLDERS



TOOL HOLDER TYPE

MAX. QUANTITY PER TOOL FRAME F NC 5020 00 ..

MAX. QUANTITY PER TOOL FRAME F NC 5220 00 ..

F NC 9285 00 03	CAPTO C6	5	24
F NC 9290 00 03	CAPTO C8	4	16
F NC 9210 00 03	HSK A32-B40	7	32
F NC 9220 00 03	HSK A40-B50	7	32
F NC 9230 00 03	HSK A50-B63	5	24
F NC 9240 00 03	HSK A63-B80	5	24
F NC 9250 00 03	HSK A80-B100	4	16
F NC 9260 00 03	HSK A100-B125	4	16
F NC 9640 00 03	2"	5	24
F NC 9650 00 03	2" 1/4	5	20
F NC 9010 00 03	58 mm	9	36
F NC 9020 00 03	65 mm	8	32
F NC 9030 00 03	75 mm	7	28
F NC 9040 00 03	87 mm	6	24
F NC 9050 00 03	105 mm	5	20

Partitioning material see page A180

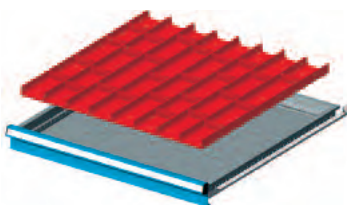

ORD. NO.

FOR FRONT HEIGHTS

F FH 2005 15 00

50-300

Set including:

16 Troughs 2 grooves
35 Plain partitions 73 mm

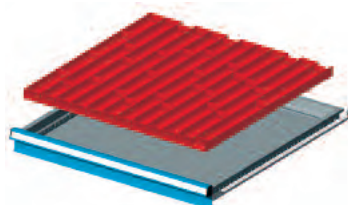

ORD. NO.

FOR FRONT HEIGHTS

F FH 2005 16 00

50-300

Set including:

16 Troughs 3 grooves
50 Plain partitions 47 mm

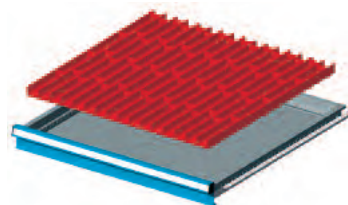

ORD. NO.

FOR FRONT HEIGHTS

F FH 2005 17 00

50-300

Set including:

16 Troughs 4 grooves
65 Plain partitions 36 mm

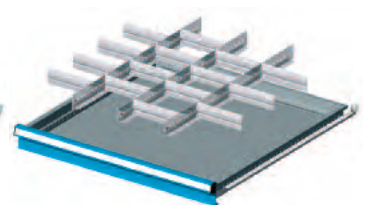

ORD. NO.

FOR FRONT HEIGHTS

F FH 2005 07 00

50

F FH 2007 07 00

75

F FH 2010 07 00

100-125

F FH 2015 07 00

150-175

F FH 2020 07 00

200-250

Set including:

3 Slotted partitions 610 mm
15 Plain partitions 149 mm

Partitioning material see page A96 - A97

ORGANIZE SPACE

LET'S REORG



■ **WORKSTATIONS SERIES WORK**

SEVERAL WORKTOPS TYPES AVAILABLE

STANDARDISED ELECTRIC AND PNEUMATIC SYSTEM

VERSATILE

SEVERAL ACCESSORIES SERIES



GANZE SPACE LET'S REOR

SERIES WORK

WOODEN WORKTOPS

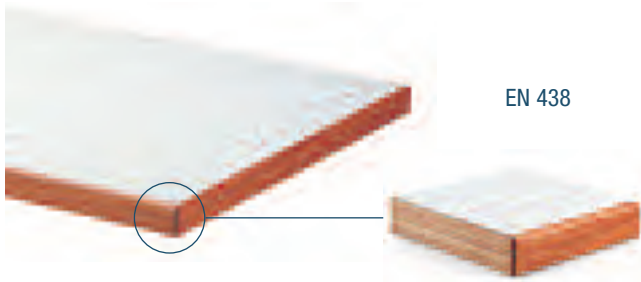

EN 438

MULTIPLEX WORKTOP COVERED WITH GREY LAMINATE WITH SOLID WOOD EDGING
This is a multiplex worktop to which a sheet of light grey matt laminate has been glued. The edges are finished in a solid beech wood.

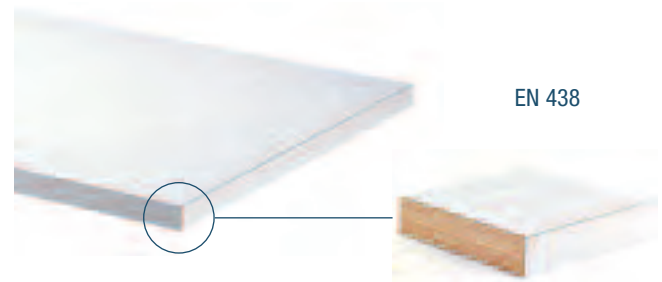

EN 438

MULTIPLEX WORKTOP COVERED WITH GREY LAMINATE WITH LAMINATE EDGING
This is a multiplex worktop to which a sheet of light grey matt laminate has been glued. The edges are also finished with the same laminate.

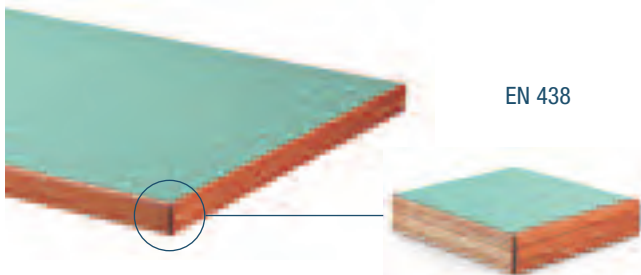

EN 438

MULTIPLEX WORKTOP COVERED WITH GREEN LAMINATE WITH SOLID WOOD EDGING
This is a multiplex worktop to which a sheet of light green matt laminate has been glued. The edges are finished in a solid beech wood.

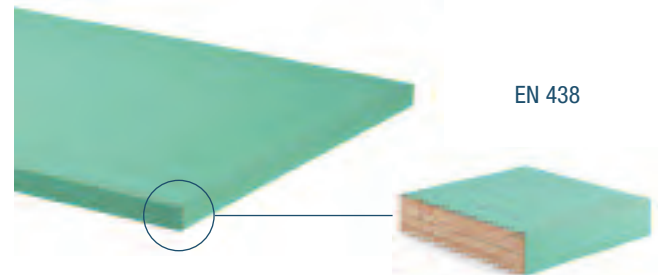

EN 438

MULTIPLEX WORKTOP COVERED WITH GREEN LAMINATE WITH LAMINATE EDGING
This is a multiplex worktop to which a sheet of light green matt laminate has been glued. The edges are also finished with the same laminate.

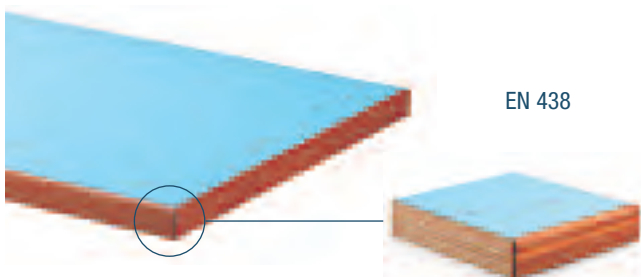

EN 438

MULTIPLEX WORKTOP COVERED WITH BLUE LAMINATE WITH SOLID WOOD EDGING
This is a multiplex worktop to which a sheet of light blue matt laminate has been glued. The edges are finished in a solid beech wood.

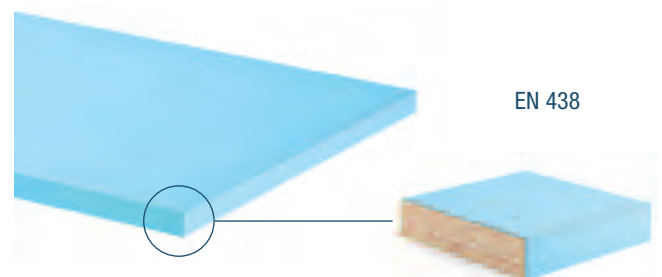

EN 438

MULTIPLEX WORKTOP COVERED WITH BLUE LAMINATE WITH LAMINATE EDGING
This is a multiplex worktop to which a sheet of light blue matt laminate has been glued. The edges are also finished with the same laminate.

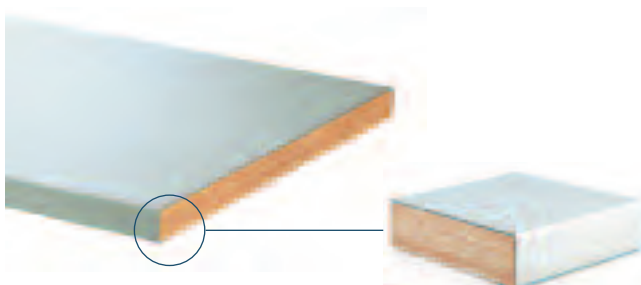

MULTIPLEX WORKTOP WITH GALVANISED STEEL COVER

This includes a multiplex worktop covered with a 2 mm thickness galvanised layer of sheet steel. This type of covering makes the worktop abrasion, oil and grease resistant.

For other types of worktops see catalogue **no. 300 Workstations**

MULTIPLEX WORKTOP

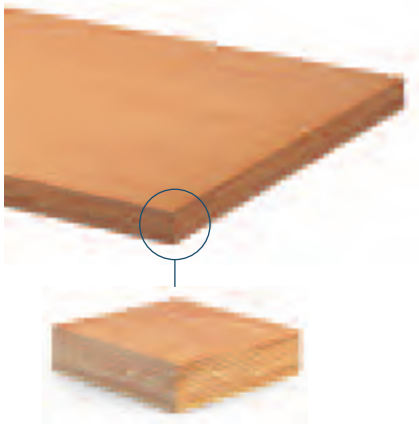

The multiplex worktop includes various layers of beech wood which are planed, glued and pressed together. This makes the worktop non-deformable and load and wear resistant.

WORKTOP DIMENSION mm	ORD. NO. 30 mm THICKNESS	ORD. NO. 40 mm THICKNESS	ORD. NO. 50 mm THICKNESS
1024x750	-	F BI A214 00 00	-
1024x800	-	-	F BI A514 00 00
1300x750	-	F BI A228 00 00	F BI A428 00 00
1300x800	-	F BI A328 00 00	F BI A528 00 00
1500x750	-	F BI A242 00 00	F BI A442 00 00
1500x800	*F BI A142 00 00	F BI A342 00 00	F BI A542 00 00
2000x750	-	F BI A270 00 00	F BI A470 00 00
2000x800	*F BI A170 00 00	F BI A370 00 00	F BI A570 00 00
2500x750	-	F BI A284 00 00	F BI A484 00 00
2500x800	-	F BI A384 00 00	F BI A584 00 00
3000x750	-	**F BI A298 00 00	*F BI A498 00 00
3000x800	-	**F BI A398 00 00	*F BI A598 00 00

**For modular workbenches only

*For mobile workbenches series F CA - F CC

WORKTOP WITH 3 CROSS-GLUED LAYERS

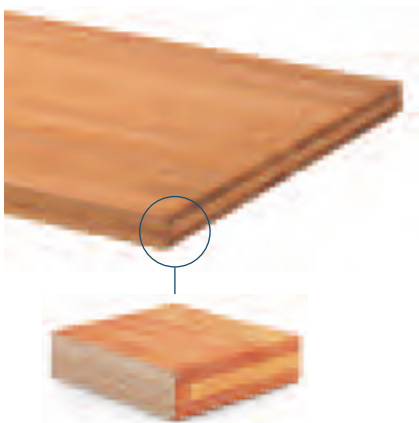

This is made from three cross-glued layers of beech wood in order to form a smooth surface which is then treated with an antiseptic material. The three layers are joined together by a toothed milling process which offers a larger connection surface.

WORKTOP DIMENSION mm	ORD. NO. 30 mm THICKNESS	ORD. NO. 40 mm THICKNESS	ORD. NO. 50 mm THICKNESS
1024x750	-	-	-
1024x800	-	-	-
1300x750	-	-	F BK A428 00 00
1300x800	-	-	F BK A528 00 00
1500x750	-	-	F BK A442 00 00
1500x800	-	-	F BK A542 00 00
2000x750	-	-	F BK A470 00 00
2000x800	-	-	F BK A570 00 00
2500x750	-	-	F BK A484 00 00
2500x800	-	-	F BK A584 00 00
3000x750	-	-	F BK A498 00 00
3000x800	-	-	F BK A598 00 00

STEEL COVER WITH OIL PROOF RUBBER COATING

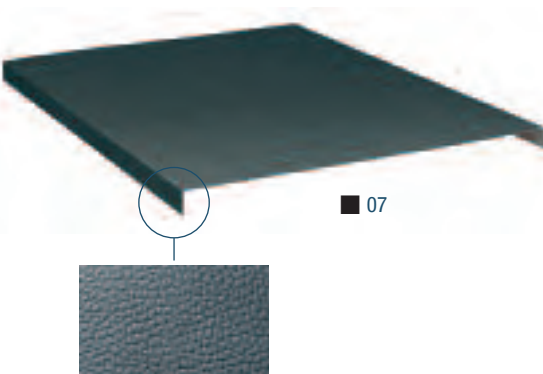

This rubber is between 1.2 and 1.5 mm thickness. The rubber-coated electrogalvanised steel sheet featuring a L-shaped profile at the two long sides, can also be supplied separately. It is easy to be fitted as no screws are required.

WORKTOP DIMENSION mm	ORD. NO. 33 mm THICKNESS	ORD. NO. 43 mm THICKNESS	ORD. NO. 53 mm THICKNESS
1024x750	-	F BL 2630 00 07	-
1024x800	-	-	F BL 2835 00 07
1300x750	-	F BL 2645 00 07	F BL 2845 00 07
1300x800	-	F BL 2650 00 07	F BL 2850 00 07
1500x750	-	F BL 2660 00 07	F BL 2860 00 07
1500x800	F BL 2465 00 07	F BL 2665 00 07	F BL 2865 00 07
2000x750	-	F BL 2690 00 07	F BL 2890 00 07
2000x800	F BL 2495 00 07	F BL 2695 00 07	F BL 2895 00 07
2500x750	-	F BL 2705 00 07	F BL 2905 00 07
2500x800	-	F BL 2710 00 07	F BL 2910 00 07
3000x750	-	F BL 2720 00 07	F BL 2920 00 07
3000x800	-	F BL 2725 00 07	F BL 2925 00 07

SERIES WORK 13

LENGTH = 1300 mm DEPTH = 800 mm (27x36 Eh)



ORD. NO. F BH A328 S1 04
RAL 5012

27 EH (447 mm)



36 EH (600 mm)

WORKSTATION

ORD. NO.

F BH A328 S1 04

Dimensions mm 1300x800x840/1472 h

Tools and drawer partitioning sets excluded

All the workbenches series WORK components are supplied without pre-drilling and bolts. To fix the components to the workbenches series WORK it is necessary to order the following **FIXING MATERIAL**:

**ORD. NO. F BL 9021 00 00**

For bench leg, adjustable bench leg, bench leg with wheels, cabinet with steel vice, bench leg for power fittings

ORD. NO. F BL 9011 00 00

Cabinets with shelves or doors

RAL 7000 F.01

RAL 6011 F.02

RAL 5012 F.04

RAL 7035 F.08

SUPPLEMENTARY PARTS ■

■ **Spare key.** Always indicate the number on the cylinder lock of the key to be replaced.

ORD. NO. R CSC 0002 00

■ **Master key.** This type of key opens all the 45 and 46 series locks.

ORD. NO. R CSC 0001 00



LENGTH = 1300 mm DEPTH = 800 mm (27x36 Eh)

SERIES WORK 13-80

SHELVES 800 mm DEEP

ORD. NO.	TYPE OF WORKTOP	THICKNESS mm	LOAD CAP. kg
F BI A528 01 04	Multiplex	50	1500
F BI A328 01 04	Multiplex	40	1200
F BK A528 01 04	3 cross-glued layers	50	1500
F BH A328 01 04	Grey laminate with solid wood	40	1200
F BH B328 01 04	Grey laminate	40	1200

Bottom shelf, ord. no. F BI 1135 00 00, load capacity: 130 kg



ORD. NO.	TYPE OF WORKTOP	THICKNESS mm	LOAD CAP. kg
F BI A528 04 04	Multiplex	50	1500
F BI A328 04 04	Multiplex	40	1200
F BK A528 04 04	3 cross-glued layers	50	1500
F BH A328 04 04	Grey laminate with solid wood	40	1200
F BH B328 04 04	Grey laminate	40	1200

Bottom shelf, ord. no. F BI 1135 00 00, load capacity: 130 kg

ORD. NO.	TYPE OF WORKTOP	THICKNESS mm	LOAD CAP. kg
F BI A528 10 04	Multiplex	50	1500
F BI A328 10 04	Multiplex	40	1200
F BK A528 10 04	3 cross-glued layers	50	1500
F BH A328 10 04	Grey laminate with solid wood	40	1200
F BH B328 10 04	Grey laminate	40	1200

Bottom shelf, ord. no. F BI 1135 00 00, load capacity: 130 kg



ORD. NO.	TYPE OF WORKTOP	THICKNESS mm	LOAD CAP. kg
F BI A528 13 04	Multiplex	50	1500
F BI A328 13 04	Multiplex	40	1500
F BK A528 13 04	3 cross-glued layers	50	1500
F BH A328 13 04	Grey laminate with solid wood	40	1500
F BH B328 13 04	Grey laminate	40	1500

Bottom shelf, ord. no. F BI 0575 01 01, load capacity: 180 kg

ORD. NO.	TYPE OF WORKTOP	THICKNESS mm	LOAD CAP. kg
F BI A528 16 04	Multiplex	50	1500
F BI A328 16 04	Multiplex	40	1500
F BK A528 16 04	3 cross-glued layers	50	1500
F BH A328 16 04	Grey laminate with solid wood	40	1500
F BH B328 16 04	Grey laminate	40	1500

Bottom shelf, ord. no. F BI 0575 01 01, load capacity: 180 kg

KEY

RAL 7000 F.01 RAL 6011 F.02 RAL 5012 F.04 RAL 7035 F.08



- PE = Retractable shelf
- All indicated loads are net and refer to evenly distributed weights

■ Sets of partitions see page A72 - A73



SERIES WORK 13-75

LENGTH = 1300 mm DEPTH = 750 mm (27x36 Eh)

SHELVES 750 mm DEEP

ORD. NO.	TYPE OF WORKTOP	THICKNESS mm	LOAD CAP. kg
F BI A428 01 04	Multiplex	50	1500
F BI A228 01 04	Multiplex	40	1200
F BK A428 01 04	3 cross-glued layers	50	1500
F BH A228 01 04	Grey laminate with solid wood	40	1200
F BH B228 01 04	Grey laminate	40	1200

Bottom shelf, ord. no. F BI 1135 00 00, load capacity: 130 kg



ORD. NO.	TYPE OF WORKTOP	THICKNESS mm	LOAD CAP. kg
F BI A428 04 04	Multiplex	50	1500
F BI A228 04 04	Multiplex	40	1200
F BK A428 04 04	3 cross-glued layers	50	1500
F BH A228 04 04	Grey laminate with solid wood	40	1200
F BH B228 04 04	Grey laminate	40	1200

Bottom shelf, ord. no. F BI 1135 00 00, load capacity: 130 kg

ORD. NO.	TYPE OF WORKTOP	THICKNESS mm	LOAD CAP. kg
F BI A428 10 04	Multiplex	50	1500
F BI A228 10 04	Multiplex	40	1200
F BK A428 10 04	3 cross-glued layers	50	1500
F BH A228 10 04	Grey laminate with solid wood	40	1200
F BH B228 10 04	Grey laminate	40	1200

Bottom shelf, ord. no. F BI 1135 00 00, load capacity: 130 kg



ORD. NO.	TYPE OF WORKTOP	THICKNESS mm	LOAD CAP. kg
F BI A428 13 04	Multiplex	50	1500
F BI A228 13 04	Multiplex	40	1500
F BK A428 13 04	3 cross-glued layers	50	1500
F BH A228 13 04	Grey laminate with solid wood	40	1500
F BH B228 13 04	Grey laminate	40	1500

Bottom shelf, ord. no. F BI 0575 01 01, load capacity: 180 kg

ORD. NO.	TYPE OF WORKTOP	THICKNESS mm	LOAD CAP. kg
F BI A428 16 04	Multiplex	50	1500
F BI A228 16 04	Multiplex	40	1500
F BK A428 16 04	3 cross-glued layers	50	1500
F BH A228 16 04	Grey laminate with solid wood	40	1500
F BH B228 16 04	Grey laminate	40	1500

Bottom shelf, ord. no. F BI 0575 01 01, load capacity: 180 kg

RAL 7000 F.01

RAL 6011 F.02

RAL 5012 F.04

RAL 7035 F.08

KEY ■

■ Sets of partitions see page A72 - A73

- PE = Retractable shelf
- All indicated loads are net and refer to evenly distributed weights



LENGTH = 1300 mm DEPTH = 750 mm (27x36 Eh)

SERIES WORK 13



■ RAL 5012

WORKSTATION**ORD. NO.****F BI A528 S1 04****Dimensions mm 1300x800x850/2120 h**

Tools and chair excluded

■ **INFO**

RAL 7000 F.01

RAL 6011 F.02

RAL 5012 F.04

RAL 7035 F.08

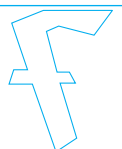

www.famispa.com

SERIES WORK 15

LENGTH = 1500 mm DEPTH = 800 mm (27x36 Eh)

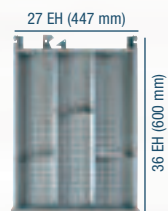

ORD. NO. F BI A542 33 04
RAL 5012



WORKSTATION

ORD. NO.

F BI A542 33 04

Dimensions mm 1500x800x890 h

Tools excluded

All the workbenches series WORK components are supplied without pre-drilling and bolts. To fix the components to the workbenches series WORK it is necessary to order the following **FIXING MATERIAL**:

**ORD. NO. F BL 9021 00 00**

For bench leg, adjustable bench leg, bench leg with wheels, cabinet with steel vice, bench leg for power fittings

ORD. NO. F BL 9011 00 00

Cabinets with shelves or doors

RAL 7000 F.01

RAL 6011 F.02

RAL 5012 F.04

RAL 7035 F.08

SUPPLEMENTARY PARTS ■

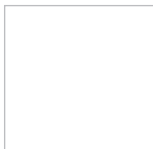

■ **Spare key.** Always indicate the number on the cylinder lock of the key to be replaced.

ORD. NO. R CSC 0002 00

■ **Master key.** This type of key opens all the 45 and 46 series locks.

ORD. NO. R CSC 0001 00



LENGTH = 1500 mm DEPTH = 800 mm (27x36 Eh)

SERIES WORK 15-80

SHELVES 800 mm DEEP

ORD. NO.	TYPE OF WORKTOP	THICKNESS mm	LOAD CAP. kg
F BI A542 01 04	Multiplex	50	1000
F BI A342 01 04	Multiplex	40	800
F BK A542 01 04	3 cross-glued layers	50	1000
F BH A342 01 04	Grey laminate with solid wood	40	800
F BH B342 01 04	Grey laminate	40	800

Bottom shelf, ord. no. F BI 1340 00 00, load capacity: 130 kg



ORD. NO.	TYPE OF WORKTOP	THICKNESS mm	LOAD CAP. kg
F BI A542 04 04	Multiplex	50	1000
F BI A342 04 04	Multiplex	40	800
F BK A542 04 04	3 cross-glued layers	50	1000
F BH A342 04 04	Grey laminate with solid wood	40	800
F BH B342 04 04	Grey laminate	40	800

Bottom shelf, ord. no. F BI 1340 00 00, load capacity: 130 kg

ORD. NO.	TYPE OF WORKTOP	THICKNESS mm	LOAD CAP. kg
F BI A542 10 04	Multiplex	50	1000
F BI A342 10 04	Multiplex	40	800
F BK A542 10 04	3 cross-glued layers	50	1000
F BH A342 10 04	Grey laminate with solid wood	40	800
F BH B342 10 04	Grey laminate	40	800

Bottom shelf, ord. no. F BI 1340 00 00, load capacity: 130 kg



ORD. NO.	TYPE OF WORKTOP	THICKNESS mm	LOAD CAP. kg
F BI A542 16 04	Multiplex	50	1500
F BI A342 16 04	Multiplex	40	1500
F BK A542 16 04	3 cross-glued layers	50	1500
F BH A342 16 04	Grey laminate with solid wood	40	1500
F BH B342 16 04	Grey laminate	40	1500

Bottom shelf, ord. no. F BI 0773 01 01, load capacity: 180 kg

ORD. NO.	TYPE OF WORKTOP	THICKNESS mm	LOAD CAP. kg
F BI A542 34 04	Multiplex	50	1500
F BI A342 34 04	Multiplex	40	1500
F BK A542 34 04	3 cross-glued layers	50	1500
F BH A342 34 04	Grey laminate with solid wood	40	1500
F BH B342 34 04	Grey laminate	40	1500

Bottom shelf, ord. no. F BI 0773 01 01, load capacity: 180 kg

KEY



- PE = Retractable shelf
- All indicated loads are net and refer to evenly distributed weights

RAL 7000 F.01 RAL 6011 F.02 RAL 5012 F.04 RAL 7035 F.08

■ Sets of partitions see page A72 - A73



SERIES WORK 15-75

LENGTH = 1500 mm DEPTH = 750 mm (27x36 Eh)

SHELVES 750 mm DEEP

ORD. NO.	TYPE OF WORKTOP	THICKNESS mm	LOAD CAP. kg
F BI A442 01 04	Multiplex	50	1000
F BI A242 01 04	Multiplex	40	800
F BK A442 01 04	3 cross-glued layers	50	1000
F BH A242 01 04	Grey laminate with solid wood	40	800
F BH B242 01 04	Grey laminate	40	800

Bottom shelf, ord. no. F BI 1340 00 00, load capacity: 130 kg



ORD. NO.	TYPE OF WORKTOP	THICKNESS mm	LOAD CAP. kg
F BI A442 04 04	Multiplex	50	1000
F BI A242 04 04	Multiplex	40	800
F BK A442 04 04	3 cross-glued layers	50	1000
F BH A242 04 04	Grey laminate with solid wood	40	800
F BH B242 04 04	Grey laminate	40	800

Bottom shelf, ord. no. F BI 1340 00 00, load capacity: 130 kg

ORD. NO.	TYPE OF WORKTOP	THICKNESS mm	LOAD CAP. kg
F BI A442 10 04	Multiplex	50	1000
F BI A242 10 04	Multiplex	40	800
F BK A442 10 04	3 cross-glued layers	50	1000
F BH A242 10 04	Grey laminate with solid wood	40	800
F BH B242 10 04	Grey laminate	40	800

Bottom shelf, ord. no. F BI 1340 00 00, load capacity: 130 kg



ORD. NO.	TYPE OF WORKTOP	THICKNESS mm	LOAD CAP. kg
F BI A442 16 04	Multiplex	50	1500
F BI A242 16 04	Multiplex	40	1500
F BK A442 16 04	3 cross-glued layers	50	1500
F BH A242 16 04	Grey laminate with solid wood	40	1500
F BH B242 16 04	Grey laminate	40	1500

Bottom shelf, ord. no. F BI 0773 01 01, load capacity: 180 kg

ORD. NO.	TYPE OF WORKTOP	THICKNESS mm	LOAD CAP. kg
F BI A442 34 04	Multiplex	50	1500
F BI A242 34 04	Multiplex	40	1500
F BK A442 34 04	3 cross-glued layers	50	1500
F BH A242 34 04	Grey laminate with solid wood	40	1500
F BH B242 34 04	Grey laminate	40	1500

Bottom shelf, ord. no. F BI 0773 01 01, load capacity: 180 kg

RAL 7000 F.01

RAL 6011 F.02

RAL 5012 F.04

RAL 7035 F.08

KEY ■

■ Sets of partitions see page A72 - A73

- PE = Retractable shelf
- All indicated loads are net and refer to evenly distributed weights



LENGTH = 1500 mm DEPTH = 750 mm (27x36 Eh)

SERIES WORK 15



■ RAL 5012

WORKSTATION**ORD. NO.****F BH A342 S1 04****Dimensions mm 1500x800x840/2110 h**

Tools, drawer partitioning sets and chair excluded

■ **INFO**

RAL 7000 F.01

RAL 6011 F.02

RAL 5012 F.04

RAL 7035 F.08



www.famispa.com

SERIES WORK 20

LENGTH = 2000 mm DEPTH = 800 mm (27x36 Eh)

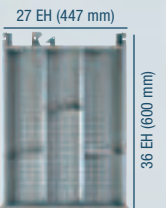

ORD. NO. F BI G570 S1 04
RAL 5012

**WORKSTATION****ORD. NO.****F BI G570 S1 04**

Dimensions mm 2000x800x850/2120 h

Tools and drawer partitioning sets excluded

All the workbenches series WORK components are supplied without pre-drilling and bolts. To fix the components to the workbenches series WORK it is necessary to order the following **FIXING MATERIAL**:

**ORD. NO. F BL 9021 00 00**

For bench leg, adjustable bench leg, bench leg with wheels, cabinet with steel vice, bench leg for power fittings

ORD. NO. F BL 9011 00 00

Cabinets with shelves or doors

RAL 7000 F.01

RAL 6011 F.02

RAL 5012 F.04

RAL 7035 F.08

SUPPLEMENTARY PARTS ■

■ **Spare key.** Always indicate the number on the cylinder lock of the key to be replaced.

ORD. NO. R CSC 0002 00

■ **Master key.** This type of key opens all the 45 and 46 series locks.

ORD. NO. R CSC 0001 00



LENGTH = 2000 mm DEPTH = 800 mm (27x36 Eh)

SERIES WORK 20-80

SHELVES 800 mm DEEP

ORD. NO.	TYPE OF WORKTOP	THICKNESS mm	LOAD CAP. kg
F BI A570 01 04	Multiplex	50	700
F BI A370 01 04	Multiplex	40	500
F BK A570 01 04	3 cross-glued layers	50	700
F BH A370 01 04	Grey laminate with solid wood	40	500
F BH B370 01 04	Grey laminate	40	500

Bottom shelf, ord. no. F BI 1840 00 00, load capacity: 85 kg



ORD. NO.	TYPE OF WORKTOP	THICKNESS mm	LOAD CAP. kg
F BI A570 04 04	Multiplex	50	700
F BI A370 04 04	Multiplex	40	500
F BK A570 04 04	3 cross-glued layers	50	700
F BH A370 04 04	Grey laminate with solid wood	40	500
F BH B370 04 04	Grey laminate	40	500

Bottom shelf, ord. no. F BI 1840 00 00, load capacity: 85 kg

ORD. NO.	TYPE OF WORKTOP	THICKNESS mm	LOAD CAP. kg
F BI A570 10 04	Multiplex	50	700
F BI A370 10 04	Multiplex	40	500
F BK A570 10 04	3 cross-glued layers	50	700
F BH A370 10 04	Grey laminate with solid wood	40	500
F BH B370 10 04	Grey laminate	40	500

Bottom shelf, ord. no. F BI 1840 00 00, load capacity: 85 kg



ORD. NO.	TYPE OF WORKTOP	THICKNESS mm	LOAD CAP. kg
F BI A570 16 04	Multiplex	50	1000
F BI A370 16 04	Multiplex	40	800
F BK A570 16 04	3 cross-glued layers	50	1000
F BH A370 16 04	Grey laminate with solid wood	40	800
F BH B370 16 04	Grey laminate	40	800

Bottom shelf, ord. no. F BI 1275 01 01, load capacity: 130 kg



ORD. NO.	TYPE OF WORKTOP	THICKNESS mm	LOAD CAP. kg
F BI A570 40 04	Multiplex	50	1000
F BI A370 40 04	Multiplex	40	800
F BK A570 40 04	3 cross-glued layers	50	1000
F BH A370 40 04	Grey laminate with solid wood	40	800
F BH B370 40 04	Grey laminate	40	800

Bottom shelf, ord. no. F BI 1275 01 01, load capacity: 130 kg

KEY



- PE = Retractable shelf
- All indicated loads are net and refer to evenly distributed weights

RAL 7000 F.01 RAL 6011 F.02 RAL 5012 F.04 RAL 7035 F.08

■ Sets of partitions see page A72 - A73

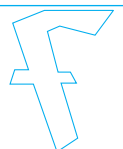

LENGTH = 2000 mm DEPTH = 750 mm (27x36 Eh)

SERIES WORK 20-75

SHELVES 750 mm DEEP

ORD. NO.	TYPE OF WORKTOP	THICKNESS mm	LOAD CAP. kg
F BI A470 01 04	Multiplex	50	700
F BI A270 01 04	Multiplex	40	500
F BK A470 01 04	3 cross-glued layers	50	700
F BH A270 01 04	Grey laminate with solid wood	40	500
F BH B270 01 04	Grey laminate	40	500

Bottom shelf, ord. no. F BI 1840 00 00, load capacity: 85 kg



ORD. NO.	TYPE OF WORKTOP	THICKNESS mm	LOAD CAP. kg
F BI A470 04 04	Multiplex	50	700
F BI A270 04 04	Multiplex	40	500
F BK A470 04 04	3 cross-glued layers	50	700
F BH A270 04 04	Grey laminate with solid wood	40	500
F BH B270 04 04	Grey laminate	40	500

Bottom shelf, ord. no. F BI 1840 00 00, load capacity: 85 kg



ORD. NO.	TYPE OF WORKTOP	THICKNESS mm	LOAD CAP. kg
F BI A470 10 04	Multiplex	50	700
F BI A270 10 04	Multiplex	40	500
F BK A470 10 04	3 cross-glued layers	50	700
F BH A270 10 04	Grey laminate with solid wood	40	500
F BH B270 10 04	Grey laminate	40	500

Bottom shelf, ord. no. F BI 1840 00 00, load capacity: 85 kg



ORD. NO.	TYPE OF WORKTOP	THICKNESS mm	LOAD CAP. kg
F BI A470 16 04	Multiplex	50	1000
F BI A270 16 04	Multiplex	40	800
F BK A470 16 04	3 cross-glued layers	50	1000
F BH A270 16 04	Grey laminate with solid wood	40	800
F BH B270 16 04	Grey laminate	40	800

Bottom shelf, ord. no. F BI 1275 01 01, load capacity: 130 kg



ORD. NO.	TYPE OF WORKTOP	THICKNESS mm	LOAD CAP. kg
F BI A470 40 04	Multiplex	50	1000
F BI A270 40 04	Multiplex	40	800
F BK A470 40 04	3 cross-glued layers	50	1000
F BH A270 40 04	Grey laminate with solid wood	40	800
F BH B270 40 04	Grey laminate	40	800

Bottom shelf, ord. no. F BI 1275 01 01, load capacity: 130 kg

RAL 7000 F.01

RAL 6011 F.02

RAL 5012 F.04

RAL 7035 F.08

KEY ■



■ Sets of partitions see page A72 - A73

- PE = Retractable shelf
- All indicated loads are net and refer to evenly distributed weights



LENGTH = 2000 mm DEPTH = 750 mm (27x36 Eh)

SERIES WORK 20



■ RAL 7035

WORKSTATION**ORD. NO.****F BI B570 S1 08****Dimensions mm 2000x800x900 h**

Tools and drawer partitioning sets excluded

■ **INFO**

RAL 7000 F.01

RAL 6011 F.02

RAL 5012 F.04

RAL 7035 F.08

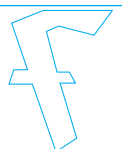
■ Sets of partitions see pages **A180**
www.famispa.com

SERIES WORK 25

LENGTH = 2500 mm DEPTH = 800 mm (27x36 Eh)



ORD. NO. F BI A584 S1 04
RAL 5012

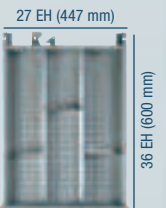

WORKSTATION

ORD. NO.

F BI A584 S1 04

Dimensions mm 2500x800x750/1150 h

Tools and drawer partitioning sets excluded

All the workbenches series WORK components are supplied without pre-drilling and bolts. To fix the components to the workbenches series WORK it is necessary to order the following **FIXING MATERIAL**:

**ORD. NO. F BL 9021 00 00**

For bench leg, adjustable bench leg, bench leg with wheels, cabinet with steel vice, bench leg for power fittings

ORD. NO. F BL 9011 00 00

Cabinets with shelves or doors

RAL 7000 F.01

RAL 6011 F.02

RAL 5012 F.04

RAL 7035 F.08

SUPPLEMENTARY PARTS ■



■ **Spare key.** Always indicate the number on the cylinder lock of the key to be replaced.

ORD. NO. R CSC 0002 00

■ **Master key.** This type of key opens all the 45 and 46 series locks.

ORD. NO. R CSC 0001 00



LENGTH = 2500 mm DEPTH = 800 mm (27x36 Eh)

SERIES WORK 25-80

SHELVES 800 mm DEEP



ORD. NO.	TYPE OF WORKTOP	THICKNESS mm	LOAD CAP. kg
F BI A584 01 04	Multiplex	50	1000
F BI A384 01 04	Multiplex	40	800
F BK A584 01 04	3 cross-glued layers	50	1000
F BH A384 01 04	Grey laminate with solid wood	40	800
F BH B384 01 04	Grey laminate	40	800

Bottom shelf, ord. no. F BI 2100 00 00, load capacity: 260 kg



ORD. NO.	TYPE OF WORKTOP	THICKNESS mm	LOAD CAP. kg
F BI A584 04 04	Multiplex	50	1000
F BI A384 04 04	Multiplex	40	800
F BK A584 04 04	3 cross-glued layers	50	1000
F BH A384 04 04	Grey laminate with solid wood	40	800
F BH B384 04 04	Grey laminate	40	800

Bottom shelf, ord. no. F BI 2100 00 00, load capacity: 260 kg

ORD. NO.	TYPE OF WORKTOP	THICKNESS mm	LOAD CAP. kg
F BI A584 46 04	Multiplex	50	1000
F BI A384 46 04	Multiplex	40	800
F BK A584 46 04	3 cross-glued layers	50	1000
F BH A384 46 04	Grey laminate with solid wood	40	800
F BH B384 46 04	Grey laminate	40	800

Bottom shelf, ord. no. F BI 2110 01 01, load capacity: 260 kg



With 4 Schuko sockets 220-250V 10A 2P+GND and thermomagnetic switch 2P 230V AC 10A, cabled

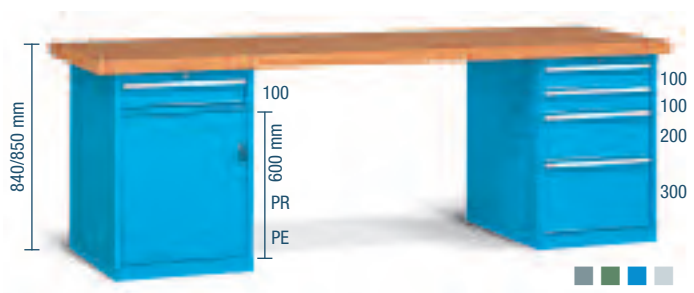

ORD. NO.	TYPE OF WORKTOP	THICKNESS mm	LOAD CAP. kg
F BI A584 28 04	Multiplex	50	1000
F BI A384 28 04	Multiplex	40	800
F BK A584 28 04	3 cross-glued layers	50	1000
F BH A384 28 04	Grey laminate with solid wood	40	800
F BH B384 28 04	Grey laminate	40	800

Bottom shelf, ord. no. F BI 1210 02 01, load capacity: 130 kg

KEY



- PE = Retractable shelf ■ PR = Adjustable shelf
- All indicated loads are net and refer to evenly distributed weights

RAL 7000 F.01 RAL 6011 F.02 RAL 5012 F.04 RAL 7035 F.08

■ Sets of partitions see page A72 - A73



SERIES WORK 25-75

LENGTH = 2500 mm DEPTH = 750 mm (27x36 Eh)

SHELVES 750 mm DEEP

ORD. NO.	TYPE OF WORKTOP	THICKNESS mm	LOAD CAP. kg
F BI A484 01 04	Multiplex	50	1000
F BI A284 01 04	Multiplex	40	800
F BK A484 01 04	3 cross-glued layers	50	1000
F BH A284 01 04	Grey laminate with solid wood	40	800
F BH B284 01 04	Grey laminate	40	800

Bottom shelf, ord. no. F BI 2100 00 00, load capacity: 260 kg



ORD. NO.	TYPE OF WORKTOP	THICKNESS mm	LOAD CAP. kg
F BI A484 04 04	Multiplex	50	1000
F BI A284 04 04	Multiplex	40	800
F BK A484 04 04	3 cross-glued layers	50	1000
F BH A284 04 04	Grey laminate with solid wood	40	800
F BH B284 04 04	Grey laminate	40	800

Bottom shelf, ord. no. F BI 2100 00 00, load capacity: 260 kg

ORD. NO.	TYPE OF WORKTOP	THICKNESS mm	LOAD CAP. kg
F BI A484 46 04	Multiplex	50	1000
F BI A284 46 04	Multiplex	40	800
F BK A484 46 04	3 cross-glued layers	50	1000
F BH A284 46 04	Grey laminate with solid wood	40	800
F BH B284 46 04	Grey laminate	40	800

Bottom shelf, ord. no. F BI 2110 01 01, load capacity: 260 kg



With 4 Schuko sockets 220-250V 10A 2P+GND and thermomagnetic switch 2P 230V AC 10A, cabled



ORD. NO.	TYPE OF WORKTOP	THICKNESS mm	LOAD CAP. kg
F BI A484 28 04	Multiplex	50	1000
F BI A284 28 04	Multiplex	40	800
F BK A484 28 04	3 cross-glued layers	50	1000
F BH A284 28 04	Grey laminate with solid wood	40	800
F BH B284 28 04	Grey laminate	40	800

Bottom shelf, ord. no. F BI 1210 02 01, load capacity: 130 kg

RAL 7000 F.01

RAL 6011 F.02

RAL 5012 F.04

RAL 7035 F.08

KEY ■

■ Sets of partitions see page A72 - A73

- PE = Retractable shelf
- PR = Adjustable shelf
- All indicated loads are net and refer to evenly distributed weights



LENGTH = 2500 mm DEPTH = 750 mm (27x36 Eh)

SERIES WORK 25



■ RAL 7035

WORKSTATION

ORD. NO.

F BI A584 S2 08

Dimensions mm 2500x800x900 h

Tools and drawer partitioning sets excluded

■ INFO

RAL 7000 F.01 RAL 6011 F.02 RAL 5012 F.04 RAL 7035 F.08

■ Sets of partitions see page A180



www.famispa.com



SERIES WORK 30

LENGTH = 3000 mm DEPTH = 800 mm (27x36 Eh)

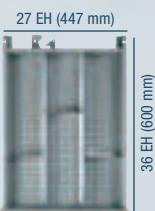

ORD. NO. F BI A598 S1 04
RAL 5012

**WORKSTATION****ORD. NO.****F BI A598 S1 04****Dimensions mm 3000x800x850/2120 h**

Complete with multi-purpose back panels. Tools and set of partitioning material for drawers excluded.

All the workbenches series WORK components are supplied without pre-drilling and bolts. To fix the components to the workbenches series WORK it is necessary to order the following **FIXING MATERIAL**:

**ORD. NO. F BL 9021 00 00**

For bench leg, adjustable bench leg, bench leg with wheels, cabinet with steel vice, bench leg for power fittings

ORD. NO. F BL 9011 00 00

Cabinets with shelves or doors

RAL 7000 F.01

RAL 6011 F.02

RAL 5012 F.04

RAL 7035 F.08

SUPPLEMENTARY PARTS ■

■ **Spare key.** Always indicate the number on the cylinder lock of the key to be replaced.

ORD. NO. R CSC 0002 00

■ **Master key.** This type of key opens all the 45 and 46 series locks.

ORD. NO. R CSC 0001 00



LENGTH = 3000 mm DEPTH = 800 mm (27x36 Eh)

SERIES WORK 30-80

SHELVES 800 mm DEEP

ORD. NO.	TYPE OF WORKTOP	THICKNESS mm	LOAD CAP. kg
F BI A598 01 04	Multiplex	50	800
F BK A598 01 04	3 cross-glued layers	50	800
F BH A598 01 04	Grey laminate with solid wood	50	800
F BH B598 01 04	Grey laminate	50	800

Bottom shelf, ord. no. F BI 2690 00 00, load capacity: 210 kg



ORD. NO.	TYPE OF WORKTOP	THICKNESS mm	LOAD CAP. kg
F BI A598 04 04	Multiplex	50	800
F BK A598 04 04	3 cross-glued layers	50	800
F BH A598 04 04	Grey laminate with solid wood	50	800
F BH B598 04 04	Grey laminate	50	800

Bottom shelf, ord. no. F BI 2690 00 00, load capacity: 210 kg

ORD. NO.	TYPE OF WORKTOP	THICKNESS mm	LOAD CAP. kg
F BI A598 22 04	Multiplex	50	800
F BK A598 22 04	3 cross-glued layers	50	800
F BH A598 22 04	Grey laminate with solid wood	50	800
F BH B598 22 04	Grey laminate	50	800

Bottom shelf, ord. no. F BI 2510 01 01, load capacity: 210 kg

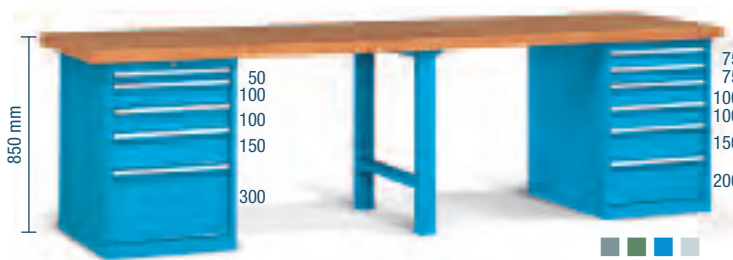

ORD. NO.	TYPE OF WORKTOP	THICKNESS mm	LOAD CAP. kg
F BI A598 16 04	Multiplex	50	1500
F BK A598 16 04	Multiplex	50	1500
F BH A598 16 04	3 cross-glued layers	50	1500
F BH B598 16 04	Grey laminate with solid wood	50	1500

Bottom shelf, ord. no. F BI 1710 02 01, load capacity: 360 kg

KEY



- PE = Retractable shelf
- All indicated loads are net and refer to evenly distributed weights

RAL 7000 F.01 RAL 6011 F.02 RAL 5012 F.04 RAL 7035 F.08

■ Sets of partitions see page A72 - A73



SERIES WORK 30-75

LENGTH = 3000 mm DEPTH = 750 mm (27x36 Eh)

SHELVES 750 mm DEEP

ORD. NO.	TYPE OF WORKTOP	THICKNESS mm	LOAD CAP. kg
F BI A498 01 04	Multiplex	50	800
F BK A498 01 04	3 cross-glued layers	50	800
F BH A498 01 04	Grey laminate with solid wood	50	800
F BH B498 01 04	Grey laminate	50	800

Bottom shelf, ord. no. F BI 2690 00 00, load capacity: 210 kg



ORD. NO.	TYPE OF WORKTOP	THICKNESS mm	LOAD CAP. kg
F BI A498 04 04	Multiplex	50	800
F BK A498 04 04	3 cross-glued layers	50	800
F BH A498 04 04	Grey laminate with solid wood	50	800
F BH B498 04 04	Grey laminate	50	800

Bottom shelf, ord. no. F BI 2690 00 00, load capacity: 210 kg

ORD. NO.	TYPE OF WORKTOP	THICKNESS mm	LOAD CAP. kg
F BI A498 22 04	Multiplex	50	800
F BK A498 22 04	3 cross-glued layers	50	800
F BH A498 22 04	Grey laminate with solid wood	50	800
F BH B498 22 04	Grey laminate	50	800

Bottom shelf, ord. no. F BI 2510 01 01, load capacity: 210 kg

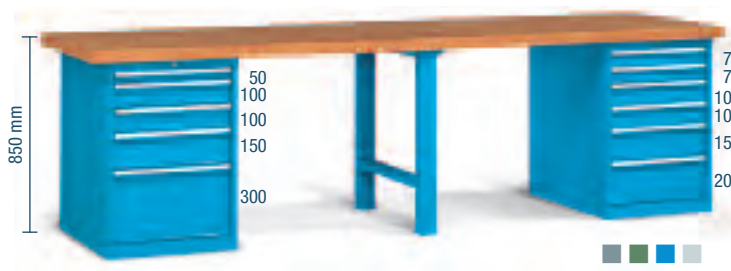

ORD. NO.	TYPE OF WORKTOP	THICKNESS mm	LOAD CAP. kg
F BI A498 16 04	Multiplex	50	1500
F BK A498 16 04	Multiplex	50	1500
F BH A498 16 04	3 cross-glued layers	50	1500
F BH B498 16 04	Grey laminate with solid wood	50	1500

Bottom shelf, ord. no. F BI 1710 02 01, load capacity: 360 kg

RAL 7000 F.01

RAL 6011 F.02

RAL 5012 F.04

RAL 7035 F.08

KEY ■

■ Sets of partitions see page A72 - A73

- PE = Retractable shelf ■ PR = Adjustable shelf
- All indicated loads are net and refer to evenly distributed weights



LENGTH = 3000 mm DEPTH = 750 mm (27x36 Eh)

SERIES WORK 30

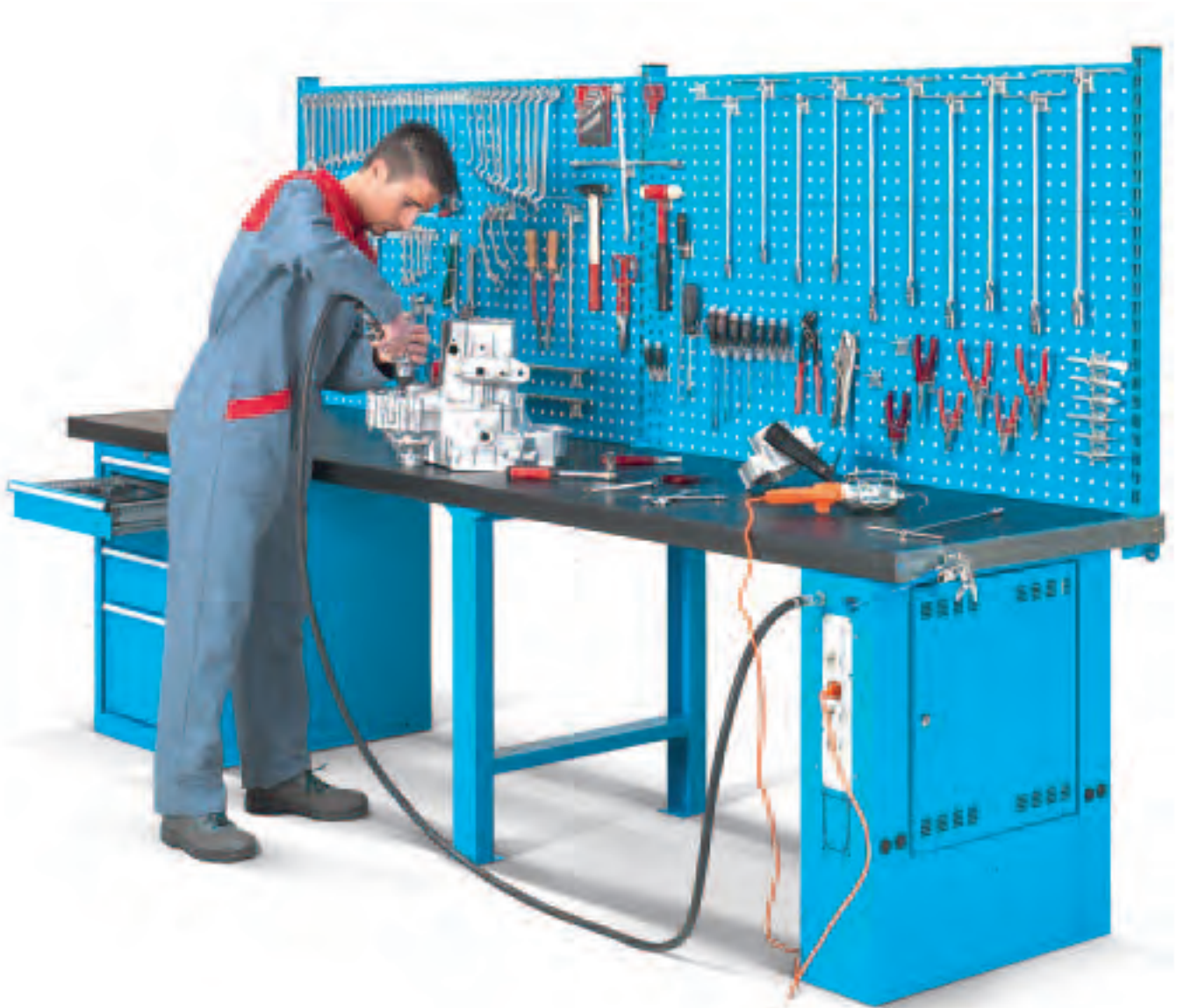

■ RAL 5012

WORKSTATION**ORD. NO.****F BI G598 S1 04****Dimensions mm 3000x800x900/1830 h**

Tools and set of partitioning material for drawers excluded

■ **INFO**

RAL 7000 F.01

RAL 6011 F.02

RAL 5012 F.04

RAL 7035 F.08



www.famispa.com

LENGTH = 1300 mm DEPTH = 800 mm (27x36 Eh)

SERIES WORK-ROL

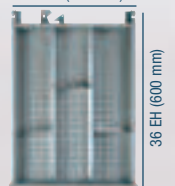

27 EH (447 mm)



All the workbenches series WORK components are supplied without pre-drilling and bolts. To fix the components to the workbenches series WORK it is necessary to order the following **FIXING MATERIAL**:

**ORD. NO. F BL 9021 00 00**

For bench leg, adjustable bench leg, bench leg with wheels, cabinet with steel vice, bench leg for power fittings

ORD. NO. F BL 9011 00 00

Cabinets with shelves or doors

RAL 7000 F.01

RAL 6011 F.02

RAL 5012 F.04

RAL 7035 F.08

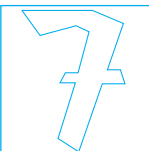
SUPPLEMENTARY PARTS ■

■ **Spare key.** Always indicate the number on the cylinder lock of the key to be replaced.

ORD. NO. R CSC 0002 00

■ **Master key.** This type of key opens all the 45 and 46 series locks.

ORD. NO. R CSC 0001 00



LENGTH = 1300 mm DEPTH = 800 mm (27x36 Eh)

SERIES WORK-ROL

BACK AND SIDE UPSTAND OF MULTIPLEX

SIDE UPSTAND OF MULTIPLEX

ORD. NO.	DIM. mm	FOR WORKSTATION
F BL 5610 00 00	762x12x100 h	750 mm
F BL 5635 00 00	770x20x150 h	750 mm
F BL 5645 00 00	770x20x200 h	750 mm
F BL 5630 00 00	812x12x100 h	800 mm
F BL 5640 00 00	820x20x150 h	800 mm
F BL 5650 00 00	820x20x200 h	800 mm

BACK UPSTAND OF MULTIPLEX

ORD. NO.	DIM. mm	FOR WORKSTATION
F BL 5720 00 00	1300x12x100 h	1300 mm
F BL 5790 00 00	1300x20x150 h	1300 mm
F BL 5860 00 00	1300x20x200 h	1300 mm
F BL 5730 00 00	1500x12x100 h	1500 mm
F BL 5800 00 00	1500x20x150 h	1500 mm
F BL 5870 00 00	1500x20x200 h	1500 mm
F BL 5750 00 00	2000x12x100 h	2000 mm
F BL 5820 00 00	2000x20x150 h	2000 mm
F BL 5890 00 00	2000x20x200 h	2000 mm

ORD. NO.

F CA C328 S1 04

Complete with upstands and vice

Dimensions mm 1350x820x1000 h

Tools and drawer partitioning sets excluded



■ RAL 5012

■ RAL 7000+
■ RAL 5012



■ Mobile workstations FLEXA see page A38 - A51

■ INFO

RAL 7000 F.01

RAL 6011 F.02

RAL 5012 F.04

RAL 7035 F.08



www.famispa.com



LENGTH = 1300 mm DEPTH = 750 mm (27x36 Eh)

SERIES WORK-ROL 13-80

SHELVES 800 mm DEEP



ORD. NO.	TYPE OF WHEEL	THICKNESS mm	Ø mm	LOAD CAP. kg
F CC C328 13 04	Standard rubber	40	125	220
F CC Q328 13 04	Nylon	40	125	500

- Complete with:
- 2 braked swivel wheels Ø 125 mm
 - 2 fixed wheels Ø 125 mm
 - 3 normal extension drawers
 - 1 bench leg with power fittings
 - 1 electrical system
 - 1 pneumatic system

Dimensions mm 1330x800x890 h

ORD. NO.	TYPE OF WHEEL	THICKNESS mm	Ø mm	LOAD CAP. kg
F CC C328 14 04	Standard rubber	40	125	220
F CC Q328 14 04	Nylon	40	125	500

- Complete with:
- 2 braked swivel wheels, 2 fixed wheels Ø 125 mm
 - 3 normal extension drawers
 - 1 roller shutter cabinet with 1 set of 16 hooks (tools excluded)
 - 2 support columns with dual slots, 1 perforated back panel
 - 1 2x18W lighting system and 1 bench leg with power fittings
 - 1 electrical system, 1 pneumatic system

Dimensions mm 1330x800x2160 h



■ Mobile workstations FLEXA see page A38 - A51

■ RAL 7035+ ■ RAL 5012

RAL 7000 F.01 RAL 6011 F.02 RAL 5012 F.04 RAL 7035 F.08

KEY ■

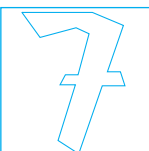

■ Sets of partitions see page A72 - A73

■ All indicated loads are net and refer to evenly distributed weights



SHELVES 800 mm DEEP

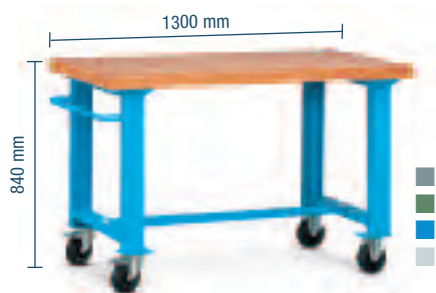

ORD. NO.	TYPE OF WHEEL	THICKNESS mm	Ø mm	LOAD CAP. kg
F CA C328 02 04	Standard rubber	40	125	240
F CA Q328 02 04	Nylon	40	125	600
Complete with:				
2 braked swivel wheels Ø 125 mm				
2 fixed wheels Ø 125 mm				
Dimensions mm 1330x800x840 h				

SHELVES 750 mm DEEP

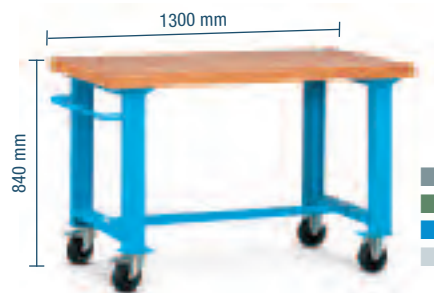

ORD. NO.	TYPE OF WHEEL	THICKNESS mm	Ø mm	LOAD CAP. kg
F CA C228 02 04	Standard rubber	40	125	240
F CA Q228 02 04	Nylon	40	125	600
Complete with:				
2 braked swivel wheels Ø 125 mm				
2 fixed wheels Ø 125 mm				
Dimensions mm 1330x750x840 h				

SHELVES 800 mm DEEP



ORD. NO.	TYPE OF WHEEL	THICKNESS mm	Ø mm	LOAD CAP. kg
F CA C328 03 04	Standard rubber	40	125	220
F CA Q328 03 04	Nylon	40	125	600
Complete with:				
2 braked swivel wheels Ø 125 mm				
2 fixed wheels Ø 125 mm				
Dimensions mm 1330x800x840 h				

SHELVES 750 mm DEEP



ORD. NO.	TYPE OF WHEEL	THICKNESS mm	Ø mm	LOAD CAP. kg
F CA C228 03 04	Standard rubber	40	125	220
F CA Q228 03 04	Nylon	40	125	600
Complete with:				
2 braked swivel wheels Ø 125 mm				
2 fixed wheels Ø 125 mm				
Dimensions mm 1330x750x840 h				

KEY

RAL 7000 F.01

RAL 6011 F.02

RAL 5012 F.04

RAL 7035 F.08



- Sets of partitions see page A72 - A73
- All indicated loads are net and refer to evenly distributed weights



SERIES WORK-ROL 15-80/15-75

SHELVES 800 mm DEEP



ORD. NO.	TYPE OF WHEEL	THICKNESS mm	Ø mm	LOAD CAP. kg
F CA C342 02 04	Standard rubber	40	125	240
F CA Q342 02 04	Nylon	40	125	600
Complete with: 2 braked swivel wheels, 2 fixed wheels Ø 125 mm				
Dimensions mm 1530x800x840 h				

SHELVES 750 mm DEEP

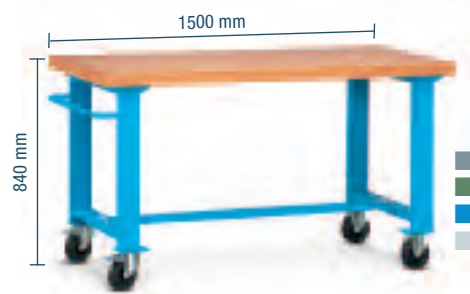

ORD. NO.	TYPE OF WHEEL	THICKNESS mm	Ø mm	LOAD CAP. kg
F CA C242 02 04	Standard rubber	40	125	240
F CA Q242 02 04	Nylon	40	125	600
Complete with: 2 braked swivel wheels, 2 fixed wheels Ø 125 mm				
Dimensions mm 1530x750x840 h				

SHELVES 800 mm DEEP



ORD. NO.	TYPE OF WHEEL	THICKNESS mm	Ø mm	LOAD CAP. kg
F CA C342 04 04	Standard rubber	40	125	200
F CA Q342 04 04	Nylon	40	125	600
Complete with: 2 braked swivel wheels, 2 fixed wheels Ø 125 mm				
Dimensions mm 1530x800x840 h				

SHELVES 750 mm DEEP



ORD. NO.	TYPE OF WHEEL	THICKNESS mm	Ø mm	LOAD CAP. kg
F CA C242 04 04	Standard rubber	40	125	200
F CA Q242 04 04	Nylon	40	125	600
Complete with: 2 braked swivel wheels, 2 fixed wheels Ø 125 mm				
Dimensions mm 1530x750x840 h				

SHELVES 800 mm DEEP



ORD. NO.	TYPE OF WHEEL	THICKNESS mm	Ø mm	LOAD CAP. kg
F CA C342 05 04	Standard rubber	40	125	240
F CA Q342 05 04	Nylon	40	125	600
Complete with: 2 braked swivel wheels, 2 fixed wheels Ø 125 mm				
Dimensions mm 1530x800x895/1295 h				

SHELVES 750 mm DEEP



ORD. NO.	TYPE OF WHEEL	THICKNESS mm	Ø mm	LOAD CAP. kg
F CA C242 05 04	Standard rubber	40	125	240
F CA Q242 05 04	Nylon	40	125	600
Complete with: 2 braked swivel wheels, 2 fixed wheels Ø 125 mm				
Dimensions mm 1530x750x895/1295 h				

RAL 7000 F.01 RAL 6011 F.02 RAL 5012 F.04 RAL 7035 F.08

KEY ■

- Sets of partitions see page A72 - A73
- All indicated loads are net and refer to evenly distributed weights



LENGTH = 2000 mm DEPTH = 800/750 mm (27x36 Eh)

SERIES WORK-ROL 20-80/20-75

SHELVES 800 mm DEEP

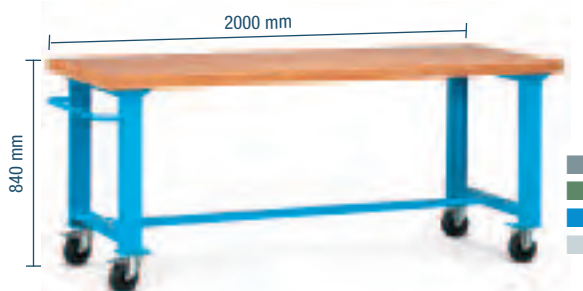

ORD. NO.	TYPE OF WHEEL	THICKNESS mm	Ø mm	LOAD CAP. kg
F CA C370 02 04	Standard rubber	40	125	220
F CA Q370 02 04	Nylon	40	125	500
Complete with: 2 braked swivel wheels, 2 fixed wheels Ø 125 mm				
Dimensions mm 2030x800x840 h				

SHELVES 750 mm DEEP

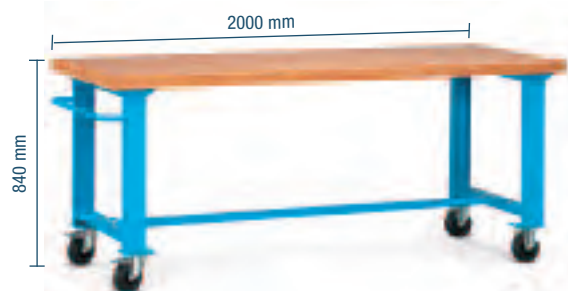

ORD. NO.	TYPE OF WHEEL	THICKNESS mm	Ø mm	LOAD CAP. kg
F CA C270 02 04	Standard rubber	40	125	220
F CA Q270 02 04	Nylon	40	125	500
Complete with: 2 braked swivel wheels, 2 fixed wheels Ø 125 mm				
Dimensions mm 2030x750x840 h				

SHELVES 800 mm DEEP

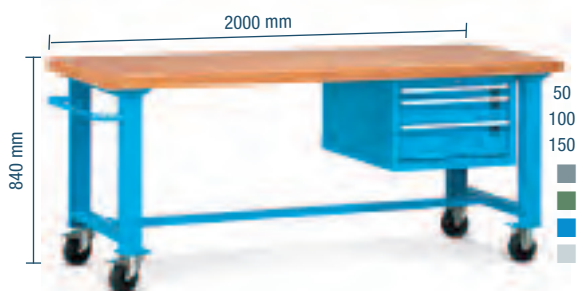

ORD. NO.	TYPE OF WHEEL	THICKNESS mm	Ø mm	LOAD CAP. kg
F CA C370 04 04	Standard rubber	40	125	180
F CA Q370 04 04	Nylon	40	125	500
Complete with: 2 braked swivel wheels, 2 fixed wheels Ø 125 mm				
Dimensions mm 2030x800x840 h				

SHELVES 750 mm DEEP

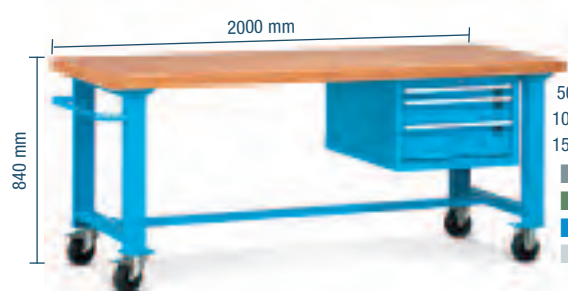

ORD. NO.	TYPE OF WHEEL	THICKNESS mm	Ø mm	LOAD CAP. kg
F CA C270 04 04	Standard rubber	40	125	180
F CA Q270 04 04	Nylon	40	125	500
Complete with: 2 braked swivel wheels, 2 fixed wheels Ø 125 mm				
Dimensions mm 2030x750x840 h				

SHELVES 800 mm DEEP

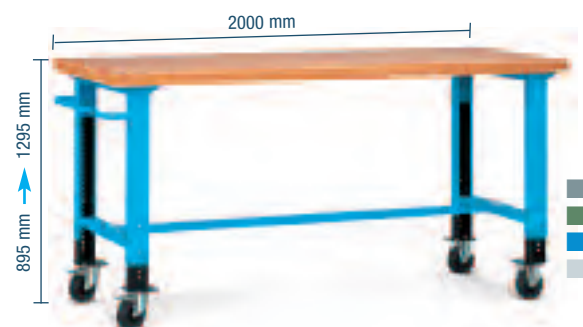

ORD. NO.	TYPE OF WHEEL	THICKNESS mm	Ø mm	LOAD CAP. kg
F CA C370 05 04	Standard rubber	40	125	220
F CA Q370 05 04	Nylon	40	125	500
Complete with: 2 braked swivel wheels, 2 fixed wheels Ø 125 mm				
Dimensions mm 2030x800x895/1295 h				

SHELVES 750 mm DEEP

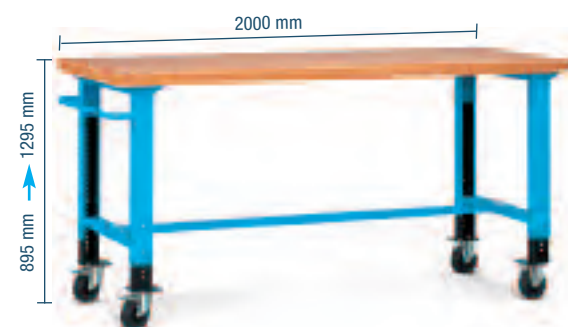

ORD. NO.	TYPE OF WHEEL	THICKNESS mm	Ø mm	LOAD CAP. kg
F CA C270 05 04	Standard rubber	40	125	220
F CA Q270 05 04	Nylon	40	125	500
Complete with: 2 braked swivel wheels, 2 fixed wheels Ø 125 mm				
Dimensions mm 2030x750x895/1295 h				

KEY

RAL 7000 F.01 RAL 6011 F.02 RAL 5012 F.04 RAL 7035 F.08



- Sets of partitions see page A72 - A73
- All indicated loads are net and refer to evenly distributed weights



SERIES WORK

BENCH LEGS

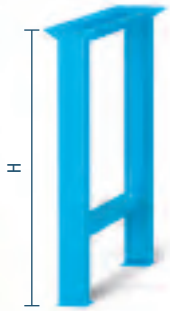

ORD. NO.	DIM. mm
F BL 6010 00 04	80x715x700 h
F BL 6025 00 04	80x715x800 h
F BL 6035 00 04	80x715x830 h
F BL 6040 00 04	80x715x850 h

■ 01 ■ 02 ■ 04 ■ 08

ADJUSTABLE BENCH LEGS

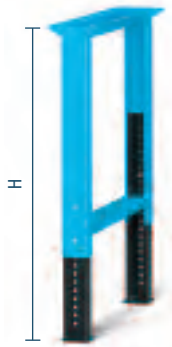

ORD. NO.	DIM. mm
F BL 6045 00 58	80x715x700/1100 h

■ 57 ■ 60 ■ 58 ■ 59

BENCH LEGS WITH WHEELS

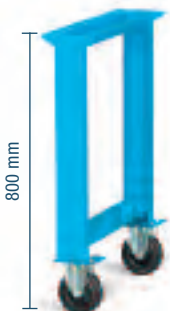

ORD. NO.	TYPE OF WHEEL	Ø mm
F BL 6075 A0 04	Standard rubber	125
F BL 6075 G0 04	No-smear	125
F BL 6075 D0 04	Elastic rubber	125
F BL 6075 K0 04	Polyurethane	125
F BL 6075 N0 04	Nylon	125

Complete with: 2 fixed wheels Ø125 mm

■ 01 ■ 02 ■ 04 ■ 08

BENCH LEGS WITH WHEELS



ORD. NO.	TYPE OF WHEEL	Ø mm
F BL 6090 C0 04	Standard rubber	125
F BL 6090 I0 04	No-smear	125
F BL 6090 F0 04	Elastic rubber	125
F BL 6090 M0 04	Polyurethane	125
F BL 6090 Q0 04	Nylon	125

Complete with: 2 braked swivel wheels Ø125 mm

■ 01 ■ 02 ■ 04 ■ 08

ADJUSTABLE BENCH LEGS WITH WHEELS



ORD. NO.	TYPE OF WHEEL	Ø mm
F BL 6055 A0 58	Standard rubber	125
F BL 6055 G0 58	No-smear	125
F BL 6055 D0 58	Elastic rubber	125
F BL 6055 K0 58	Polyurethane	125
F BL 6055 N0 58	Nylon	125

Complete with: 2 fixed wheels Ø125 mm

■ 57 ■ 60 ■ 58 ■ 59

ADJUSTABLE BENCH LEGS WITH WHEELS



ORD. NO.	TYPE OF WHEEL	Ø mm
F BL 6056 C0 58	Standard rubber	125
F BL 6056 I0 58	No-smear	125
F BL 6056 F0 58	Elastic rubber	125
F BL 6056 M0 58	Polyurethane	125
F BL 6056 Q0 58	Nylon	125

Complete with: 2 braked swivel wheels Ø125 mm

■ 57 ■ 60 ■ 58 ■ 59

CONNECTION PIECE FOR MOBILE WORKSTATION



■ 01 ■ 02 ■ 04 ■ 08

ORD. NO. CONNECTION PIECE FOR WORKSTATION LENGTH mm

F BL 6605 00 04 980 mm 1300

ORD. NO. CONNECTION PIECE FOR WORKSTATION LENGTH mm

F BL 6610 00 04 1180 mm 1500

ORD. NO. CONNECTION PIECE FOR WORKSTATION LENGTH mm

F BL 6620 00 04 1680 mm 2000

BENCH LEG WITH POWER FITTINGS

ORD. NO.	DIM. mm
F BL 6120 01 04	190x695x700 h
F BL 6125 01 04	190x695x800 h
F BL 6130 01 04	190x695x830 h
F BL 6135 01 04	190x695x850 h

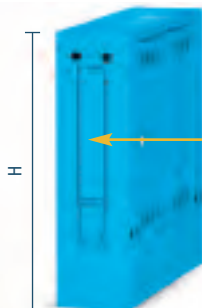

Electrical and pneumatic system see page C31.



■ 01 ■ 02 ■ 04 ■ 08

DEPTH = 726 mm (27x36 Eh)

SERIES WORK

PNEUMATIC SYSTEM WITH SINGLE WINDER AND FILTER

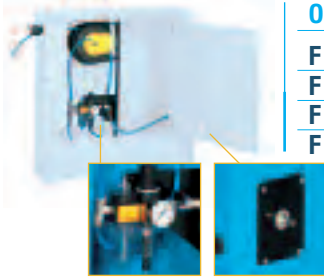

ORD. NO.	BENCH LEG HEIGHT mm
F BL 9670 70 07	700
F BL 9670 80 07	800
F BL 9670 83 07	830
F BL 9670 85 07	850

Detail of fixed rear outlet

Detail of fixed reducer assembly with lubricator on request

The pneumatic system includes:

- 1 fix rear inlet with Ø 10 mm hose and connector (1/4") with pin (Ø 9–12 mm) used to link up to the pneumatic supply by means of an extension hose (not supplied standard).
- 1 front winder including 4 metres of hose with an internal diameter of 5,5 and a 1/4" threaded tool connector, capacity approx. 9 litres per second*.
- 1 fixed front outlet with Ø 10 mm hose and 1/4" threaded connector complete with plug, capacity approx. 11 litres per second*.
- 1 filter reducer assembly with pressure gauge which can be used at maximum pressure of 10 bar, capacity approx. 11 metres per second* at an operating pressure of 6.3 bar.

*capacity can vary according to the technical characteristics of the pneumatic supply to which the system is connected.

PNEUMATIC SYSTEM WITH SINGLE WINDER



ORD. NO.	BENCH LEG HEIGHT mm
F BL 9660 70 07	700
F BL 9660 80 07	800
F BL 9660 83 07	830
F BL 9660 85 07	850

Applicable on bench leg for power fittings only



Detail of fixed rear outlet

The pneumatic system includes:

- 1 fix rear inlet with Ø 10 mm hose and connector (3/8") with pin (Ø 9–12 mm) used to link up to the pneumatic supply by means of an extension hose (not supplied standard).
- 1 front winder including 4 metres of hose with an internal diameter of 5,5 and a 1/4" threaded tool connector.
- 1 fixed front outlet with Ø 10 mm hose and 3/8" threaded connector complete with plug.

N.B. All the unions (except for those of the winder) are 3/8".

ELECTRIC SYSTEM



The bench legs for power fittings are supplied standard with a side door with a cylinder lock and 2 keys. An electric and/or a pneumatic system can be fitted in these bench legs. The socket box is also fitted standard with a thermo-magnetic switch 2P 230V AC 10A and is connected (with a hard-wearing cable sheath) to a heavy duty socket 220-240V 16A 2P+GND at the rear featuring a vertically sliding cover. The system is protected to IP30.

ORD. NO.	type and number of cabled sockets:					
	D	F	GB	I	CH	IL
F BL 9620 10 00	4	-	-	-	-	-
F BL 9620 20 00	-	4	-	-	-	-
F BL 9620 30 00	-	-	3	-	-	-
F BL 9620 40 00	-	-	-	4	-	-
F BL 9620 50 00	-	-	-	-	4	-
F BL 9620 70 00	-	-	-	-	-	4

The electric system includes a multiple socket box featuring 6 type of sockets:

- 4 sockets for large and small italian plugs 220-250V 10A 2P+GND
- 4 Schuko sockets 220-250V 10A 2P+GND
- 4 French sockets 220-250V 10A 2P+GND
- 3 British sockets 220-250V 10A 2P+GND
- 4 Swiss sockets 220-250V 10A 2P+GND
- 4 Israeli sockets 220-250V 10A 2P+GND

CABINET WITH STEEL VICE

ORD. NO.	DIM. mm
F BL 6105 01 04	312x726x800 h
F BL 6110 01 04	312x726x830 h
F BL 6115 01 04	312x726x850 h



The vice can rotate by 360°.

With steel vice 120 mm

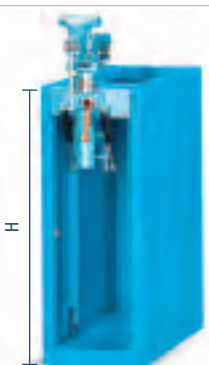

1 Open the door and...



2 ...slide it until it completely enters the vice cabinet.



3 Pull up the vice and fix it with the relative knob.



4 Adjust the vice to the required height.

SERIES WORK STANDARD B

EMPTY CABINET PREPARED FOR DRAWERS 27x36 EH

ORD. NO.	USABLE HEIGHT mm	LOAD CAP. kg	DIMENSIONS mm
F DD 1020 00 04	200	3100	564x726x283 h
F DD 1030 00 04	300	3100	564x726x383 h
F DD 1050 00 04	500	3100	564x726x600 h
F DD 1060 00 04	600	3100	564x726x700 h
F DD 1070 00 04	700	3100	564x726x800 h
F DD 1072 00 04	725	3100	564x726x825 h
F DD 1075 00 04	750	3100	564x726x850 h
F DD 1090 00 04	900	3100	564x726x1000 h



■ 01 ■ 02 ■ 04 ■ 08

PLINTHS



■ 07

ORD. NO.	HEIGHT mm
F DD 9300 00 07	50
F DD 9330 00 07	100

EMPTY CABINET WITH DOOR WITH RIGHT-HAND OPENING

ORD. NO.	DOOR HEIGHT mm	USABLE HEIGHT mm	LOAD CAP. kg	DIMENSIONS mm
F DD 1260 D0 04	600	600	3100	564x726x700 h



■ 01
■ 02
■ 04
■ 08

EMPTY CABINET WITH DOOR WITH LEFT-HAND OPENING

ORD. NO.	DOOR HEIGHT mm	USABLE HEIGHT mm	LOAD CAP. kg	DIMENSIONS mm
F DD 1261 D0 04	600	600	3100	564x726x700 h

■ Drawers cannot be fitted behind doors.

EMPTY CABINET PREPARED FOR DOORS AND DRAWERS

ORD. NO.	DOOR HEIGHT (A) mm	DRAWERS HEIGHT (B) mm	USABLE HEIGHT (C) mm	LOAD CAP. kg	DIMENSIONS mm
F DD 1150 00 04	400	75	500	3100	564x726x600 h
	400	175			
F DD 1160 00 04	425	150	600	3100	564x726x700 h
	500	75			
	400	275			
F DD 1170 00 04	425	250	700	3100	564x726x800 h
	500	175			
	575	100			
	600	75			
F DD 1172 00 04	400	300	725	3100	564x726x825 h
	425	275			
	500	200			
	575	125			
	600	100			
F DD 1175 00 04	400	325	750	3100	564x726x850 h
	425	300			
	500	225			
	575	150			
	600	125			
F DD 1190 00 04	400	475	900	3100	564x726x1000 h
	425	450			
	500	375			
	575	300			
	600	275			

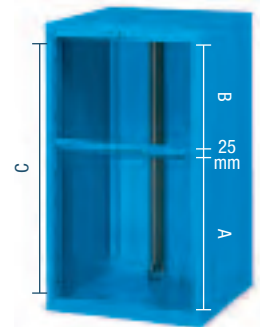

■ 01 ■ 02 ■ 04 ■ 08

■ Drawers cannot be fitted behind doors.

REVERSIBLE DOOR

ORD. NO.	HEIGHT (A) mm
F DD 9640 01 04	400
F DD 9642 01 04	425
F DD 9645 01 04	500
F DD 9649 01 04	575
F DD 9650 01 04	600



■ 01 ■ 02 ■ 04 ■ 08

■ Drawers cannot be fitted behind doors.

■ These doors can be fitted both with left-hand and right-hand opening.

SPARE LOCKS AND SPARE HANDLE

ORD. NO.
R CSR 0003 00
Spare lock (for cabinets)
R CSR 0035 00
Spare lock (for handle of the doors)
R XDA 0002 07
Spare handle (for doors)

DEPTH = 726 mm (27x36 Eh)

SERIES WORK STANDARD B

DRAWERS

ORD. NO.	FRONT HEIGHT mm	LOAD CAP. kg	USABLE DIMENSIONS mm
F DD 8050 00 04	50	60	447x600x36 h
F DD 8075 00 04	75	80	447x600x61 h
F DD 8100 00 04	100	100	447x600x86 h
F DD 8125 00 04	125	100	447x600x111 h
F DD 8150 00 04	150	100	447x600x136 h
F DD 8200 00 04	200	100	447x600x186 h
F DD 8250 00 04	250	100	447x600x236 h
F DD 8300 00 04	300	100	447x600x286 h

Normal extension (87%)

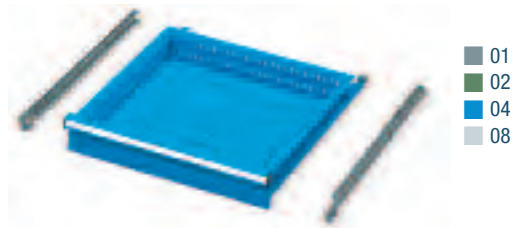

■ 01
■ 02
■ 04
■ 08

■ Drawers cannot be fitted behind doors.

RETRACTABLE SHELF

ORD. NO.	LOAD CAP. kg	USABLE DIMENSIONS mm
F DD 8000 00 04	70	435x610

Normal extension (87%)

■ 01 ■ 02 ■ 04

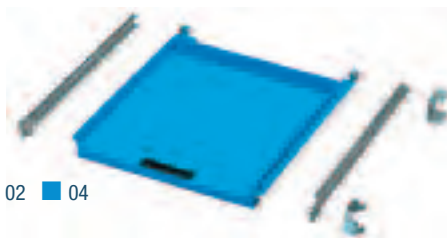

■ Set of partition material A72

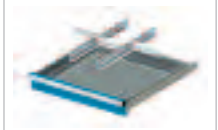

ADJUSTABLE SHELF

ORD. NO.	LOAD CAP. kg	USABLE DIMENSIONS mm
F DD 9100 01 04	70	500x600

Without extension system

■ 01 ■ 02 ■ 04



27 EH (447 mm)



36 EH (600 mm)



SERIES WORK STANDARD BH

DRAWER CABINETS SERIES F DE (BH) 27x36 EH



ORD. NO. DRAWERS

F DE 1010 01 04 1

Cabinet with 1 normal extension drawer

Drawer load capacity: 60 kg

Dim. mm 565x725x155 h



ORD. NO. DRAWERS

F DE 1020 01 04 1

Cabinet with 1 normal extension drawer

Drawer load capacity: 60 kg

Dim. mm 565x725x255 h



ORD. NO. DRAWERS

F DE 1020 02 04 2

Cabinet with 2 normal extension drawers

Drawer load capacity: 60 kg

Dim. mm 565x725x255 h



ORD. NO. DRAWERS

F DE 1030 02 04 3

Cabinet with 3 normal extension drawers

Drawer load capacity: 60 kg

Dim. mm 565x725x355 h



ORD. NO. DRAWERS

F DE 1045 04 04 4

Cabinet with 4 normal extension drawers

Drawer load capacity: 40 kg

Dim. mm 565x725x505 h

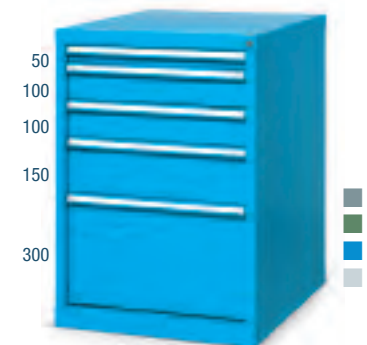

ORD. NO. DRAWERS

F DE 1070 01 04 5

Cabinet with 5 normal extension drawers

Drawer load capacity: 60 kg

Dim. mm 565x725x800 h

DRAWERS

ORD. NO.	FRONT HEIGHT mm	LOAD CAP. kg	USABLE DIMENSIONS mm
F DE 8050 00 04	50	60	447x600x36 h
F DE 8100 00 04	100	60	447x600x86 h
F DE 8150 00 04	150	60	447x600x136 h
F DE 8200 00 04	200	60	447x600x186 h
F DE 8300 00 04	300	60	447x600x286 h

Normal extension (87%)

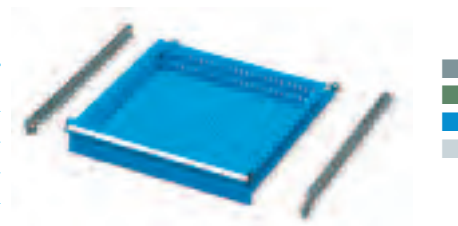

EMPTY CABINET

ORD. NO.	USABLE HEIGHT mm	DIMENSIONS mm
F DE 1010 00 04	100	565x725x155 h
F DE 1020 00 04	200	565x725x255 h
F DE 1030 00 04	300	565x725x355 h
F DE 1045 00 04	450	565x725x505 h
F DE 1070 00 04	700	565x725x800 h

■ 01 ■ 02 ■ 04 ■ 08



FIXING MATERIAL



ORD. NO. F BL 9011 00 00

RAL 7000 F.01 RAL 6011 F.02 RAL 5012 F.04 RAL 7035 F.08

SUPPLEMENTARY PARTS ■



■ All indicated loads are net and refer to evenly distributed weights



■ **Spare key.** Always indicate the number on the cylinder lock of the key to be replaced.

ORD. NO. R CSC 0002 00

■ **Master key.** This type of key opens all the 45 and 46 series locks.

ORD. NO. R CSC 0001 00



DEPTH = 600 mm (27 Eh)

SERIES WORK-FLEXA

MULTIPLEX WORKTOP 25 mm THICKNESS

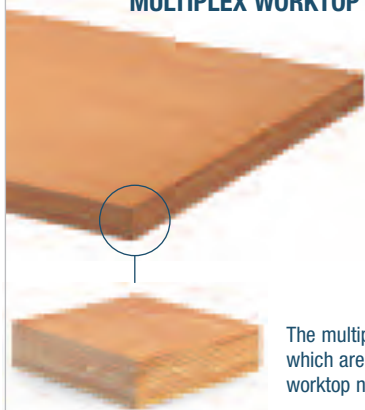

WORKTOP DIMENSION mm	ORD. NO.
860x600	F BI 0860 00 00
995x600	F BI 0995 00 00
1150x600	F BI 1150 00 00
1275x600	F BI 1275 00 00
1340x600	F BI 1340 00 00
1420x600	F BI 1420 00 00
1840x600	F BI 1840 00 00

The multiplex worktop includes various layers of beech wood which are planed, glued and pressed together. This makes the worktop non-deformable and load and wear resistant.

LEG

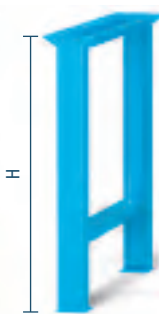

ORD. NO.	DIM. mm
F BL 6024 00 04	80x575x800 h
F BL 6039 00 04	80x575x850 h



■ RAL 5012



■ RAL 5012



■ RAL 7035

■ KEY



■ The FLEXA cabinets can be fixed to the wooden shelves by means of 4 holes on the lid. Ord. no. F BL 9011 00 00 that includes screws and threaded dowels, must be used to fix the cabinet to the shelf.



■ Cabinets see page A2 - A51

RAL 7000 F.01

RAL 6011 F.02

RAL 5012 F.04

RAL 7035 F.08



SERIES WORK-ESA



ORD. NO. F BF 1505 S1 04
RAL 5012

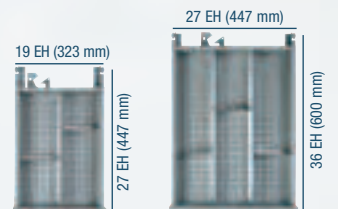

HEXAGONAL WORKSTATION

ORD. NO.

F BF 1505 S1 04

Dimensions mm 2775/2400x850 h

Tools and drawer partitioning sets excluded

POWER TOWER

ORD. NO.

F BF 8145 01 04

Including: 6 multiple socket boxes

1 thermomagnetic switch 2P 230V AC 16A I

$\Delta N=0,03A$

16 Schuko sockets 220-250V 16 A 2P+GND

Dimensions mm 800/922x230 h

Attention: uncabled towers

POWER TOWER

ORD. NO.

F BF 8145 02 04

Including: 6 multiple socket boxes

1 thermomagnetic switch 2P 230V AC 16A I

$\Delta N=0,03A$

11 Schuko sockets 220-250V 16 A 2P+GND

5 heavy-duty sockets 220-250V 16A 2P+GND

Dimensions mm 800/922x230 h

Attention: uncabled towers

RAL 7000 F.01

RAL 6011 F.02

RAL 5012 F.04

RAL 7035 F.08

SUPPLEMENTARY PARTS ■



■ Sets of partitions see page A9



■ **Spare key.** Always indicate the number on the cylinder lock of the key to be replaced.

ORD. NO. R CSC 0002 00

■ **Master key.** This type of key opens all the 45 and 46 series locks.

ORD. NO. R CSC 0001 00



LENGTH = 2400/2775 mm (19x27 Eh-27x36 Eh)

SERIES WORK-ESA



1x50
2x100
1x150
1x300

ORD. NO.	TYPE OF WORKTOP	THICKNESS mm	LOAD CAPACITY kg
F BF 1505 01 04	Multiplex	50	1000
F BF 1405 01 04	Multiplex	40	800

Including: 1 multiplex worktop
6 drawer units each with 5 normal extension 27x36 Eh drawers
Dimensions mm 2775/2400

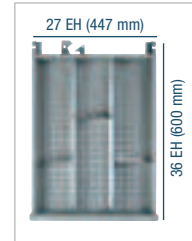

ORD. NO.

F FH 8605 22 00
Set of partitioning material for 27x36 Eh drawer with 50 mm front



1x50
2x100
1x150
1x300

ORD. NO.	TYPE OF WORKTOP	THICKNESS mm	LOAD CAPACITY kg
F BF 1505 03 04	Multiplex	50	1000
F BF 1405 03 04	Multiplex	40	800

Including: 1 multiplex worktop
6 drawer units each with 5 normal extension 19x27 Eh drawers
6 bench wired legs with power fittings each complete with 4 Schuko sockets and thermomagnetic switch 2P 230V AC 10A
Dimensions mm 2775/2400

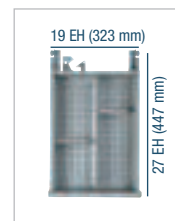

KEY

RAL 7000 F.01 RAL 6011 F.02 RAL 5012 F.04 RAL 7035 F.08



All indicated loads are net and refer to evenly distributed weights

Sets of partitions see page A9, A72 - A73



SERIES WORK-ESA

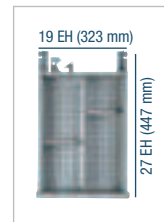

1x50
2x100
1x150
1x300

ORD. NO.	TYPE OF WORKTOP	THICKNESS mm	LOAD CAPACITY kg
F BF 1505 04 04	Multiplex	50	1000
F BF 1405 04 04	Multiplex	40	800

Including: 1 multiplex worktop

6 drawer units each with 5 normal extension 19x27 Eh drawers

6 cabinets each with 120 mm height adjustable steel vices, these rotate and can be recessed into the cabinet. The cabinet is complete with door.

Dimensions mm 2775/2400

Example of the hexagonal workstation with vices recessed inside the cabinet.

ORD. NO.
F FH 8205 04 00
Set of partitioning material for 19x27 Eh drawer with 50 mm front

ORD. NO.
F FH 8215 25 00
Set of partitioning material for 19x27 Eh drawer with 150 mm front

RAL 7000 F.01 RAL 6011 F.02 RAL 5012 F.04 RAL 7035 F.08

KEY ■

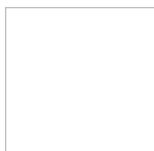
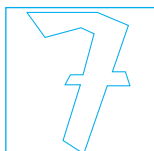

■ Sets of partitions see page A9

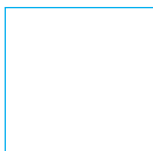

■ All indicated loads are net and refer to evenly distributed weights



LENGTH = 2400/2775 mm (27x27 Eh-27x36 Eh)

SERIES WORK-ESA



- 1x50
- 2x100
- 1x150
- 1x300

ORD. NO.	TYPE OF WORKTOP	THICKNESS mm	LOAD CAPACITY kg
F BF 1505 02 04	Multiplex	50	1000
F BF 1405 02 04	Multiplex	40	800

Including: 1 multiplex worktop

6 drawer units each with 5 normal extension 19x27 Eh drawers

6 bench wired legs with power fittings each complete with 4 Schuko sockets and thermomagnetic switch 2P 230V AC 10A

6 120 mm height adjustable steel vices, these rotate and can be recessed under the wooden worktop.

Dimensions mm 2775/2400

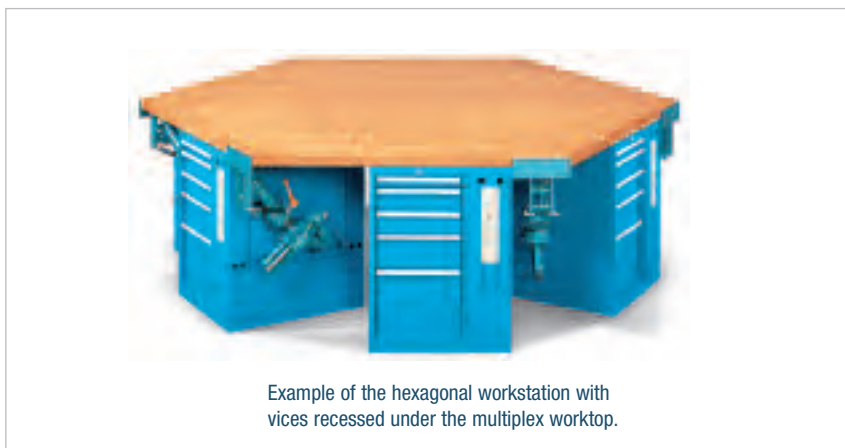

Example of the hexagonal workstation with vices recessed under the multiplex worktop.

KEY

- RAL 7000 F.01
- RAL 6011 F.02
- RAL 5012 F.04
- RAL 7035 F.08

■ Sets of partitions see page A9



■ All indicated loads are net and refer to evenly distributed weights

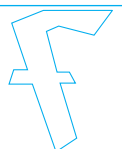

SERIES WORK-SYSTEM 15-75



ORD. NO. F BR 2242 S1 51
RAL 5012+7000

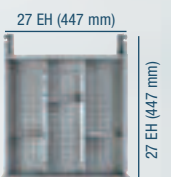

WORKSTATION

ORD. NO.

F BR 2242 S1 51

Dimensions mm 1500x750x865/1500 h

Complete with multi-purpose back panel and vertical drawer

Tools excluded

COMBINATION OF STANDARD COLOURS



- RAL 6011
- RAL 5012 +
- RAL 7000

RAL 5012
RAL 7000 F.51

RAL 6011 F.02

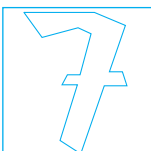

SUPPLEMENTARY PARTS ■

■ **Spare key.** Always indicate the number on the cylinder lock of the key to be replaced.

ORD. NO. R CSC 0002 00

■ **Master key.** This type of key opens all the 45 and 46 series locks.

ORD. NO. R CSC 0001 00



LENGTH = 1500 mm DEPTH = 750 mm (27x27 Eh)

SERIES WORK-SYSTEM 15-75

WORKTOP DIMENSIONS 1500x750x40 mm

ORD. NO.	TYPE OF WORKTOP	THICKNESS mm	LOAD CAPACITY kg
F BR 2242 01 51	Multiplex	40	1000
F BR 1202 01 51	Steel	40	1000



ORD. NO.	TYPE OF WORKTOP	THICKNESS mm	LOAD CAPACITY kg
F BR 2242 03 51	Multiplex	40	1000
F BR 1202 03 51	Steel	40	1000

ORD. NO.	TYPE OF WORKTOP	THICKNESS mm	LOAD CAPACITY kg
F BR 2242 05 51	Multiplex	40	1000
F BR 1202 05 51	Steel	40	1000



ORD. NO.	TYPE OF WORKTOP	THICKNESS mm	LOAD CAPACITY kg
F BR 2242 08 51	Multiplex	40	1000
F BR 1202 08 51	Steel	40	1000

ORD. NO.	TYPE OF WORKTOP	THICKNESS mm	LOAD CAPACITY kg
F BR 2242 S3 51	Multiplex	40	1000
-	Steel	40	1000

KEY



- Worktop dimensions mm 1500x750x40 h
- Unit dimensions mm 1135x630x825 h
- All indicated loads are net and refer to evenly distributed weights

■ Set of partitions see page A19

■ RAL 5012
■ RAL 7000 F.51
■ RAL 6011 F.02

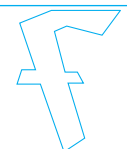

SERIES WORK-SYSTEM 20-75

LENGTH = 2000 mm DEPTH = 750 mm (27x27 Eh)

WORKTOP DIMENSIONS 2000x750x40 mm

ORD. NO.	TYPE OF WORKTOP	THICKNESS mm	LOAD CAPACITY kg
F BR 2243 01 51	Multiplex	40	1000
F BR 1203 01 51	Steel	40	1000

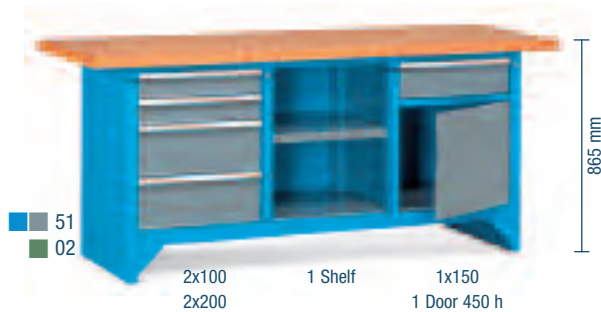
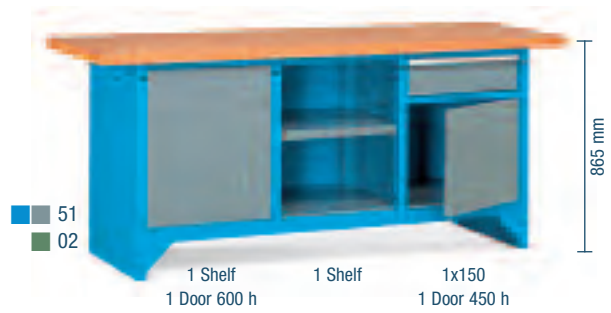

ORD. NO.	TYPE OF WORKTOP	THICKNESS mm	LOAD CAPACITY kg
F BR 2243 02 51	Multiplex	40	1000
F BR 1203 02 51	Steel	40	1000

ORD. NO.	TYPE OF WORKTOP	THICKNESS mm	LOAD CAPACITY kg
F BR 2243 03 51	Multiplex	40	1000
F BR 1203 03 51	Steel	40	1000

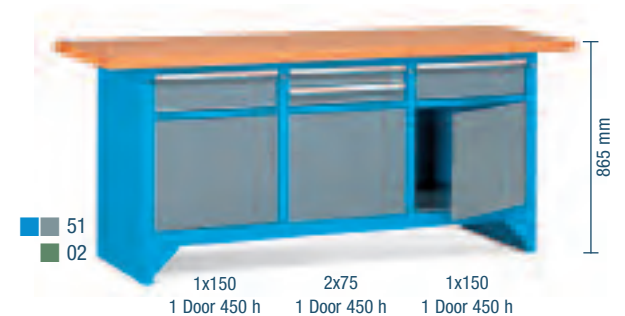

ORD. NO.	TYPE OF WORKTOP	THICKNESS mm	LOAD CAPACITY kg
F BR 2243 05 51	Multiplex	40	1000
F BR 1203 05 51	Steel	40	1000

ORD. NO.	TYPE OF WORKTOP	THICKNESS mm	LOAD CAPACITY kg
F BR 2243 09 51	Multiplex	40	1000
F BR 1203 09 51	Steel	40	1000

■ RAL 5012 ■ RAL 7000 F.51 ■ RAL 6011 F.02

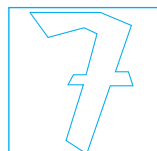

■ Set of partitions see page A19

KEY ■

- Worktop dimensions mm 2000x750x40 h
- Unit dimensions mm 1683x630x825 h
- All indicated loads are net and refer to evenly distributed weights



LENGTH = 2000 mm DEPTH = 750 mm (27x27 Eh)

SERIES WORK-SYSTEM 20-75



■ RAL 5012 +
■ RAL 7000

WORKSTATION

ORD. NO.

F BR 2343 S1 51

Dimensions mm 2000x800x865/1500 h

Equipment excluded

■ INFO



www.famispa.com

■ RAL 5012
■ RAL 7000 F.51 ■ RAL 6011 F.02



SERIES WORK-SYSTEM 25-75

WORKTOP DIMENSIONS 2500x750x40 mm

ORD. NO.	TYPE OF WORKTOP	THICKNESS mm	LOAD CAPACITY kg
F BR 2244 01 51	Multiplex	40	2000

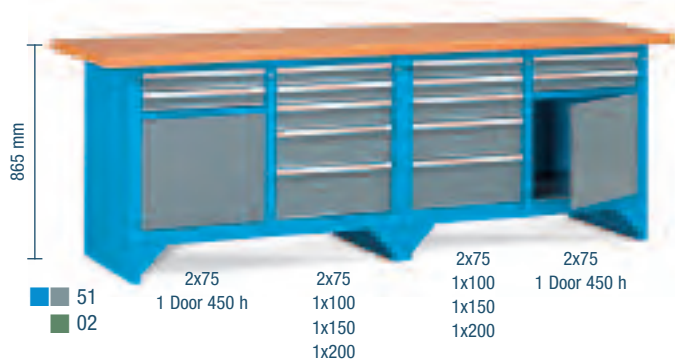
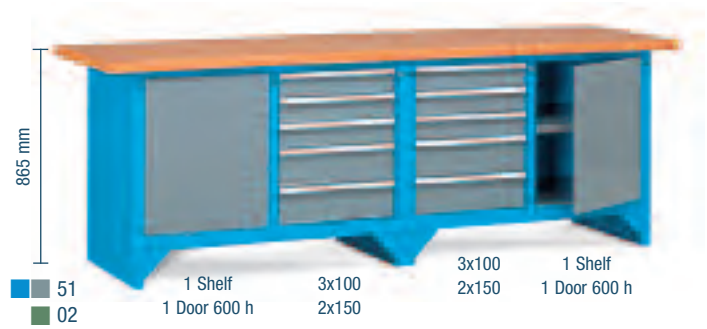

ORD. NO.	TYPE OF WORKTOP	THICKNESS mm	LOAD CAPACITY kg
F BR 2244 02 51	Multiplex	40	2000



ORD. NO.	TYPE OF WORKTOP	THICKNESS mm	LOAD CAPACITY kg
F BR 2244 03 51	Multiplex	40	2000

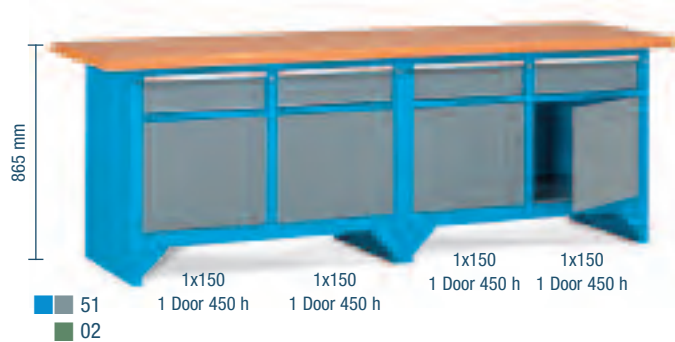

ORD. NO.	TYPE OF WORKTOP	THICKNESS mm	LOAD CAPACITY kg
F BR 2244 04 51	Multiplex	40	2000

■ RAL 5012
■ RAL 7000 F.51 ■ RAL 6011 F.02

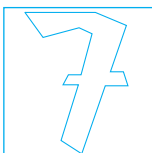

■ Set of partitions see page A19

KEY ■

- Worktop dimensions mm 2500x750x40 h
- Unit dimensions mm 1135x630x825 h + 1135x630x825 h
- All indicated loads are net and refer to evenly distributed weights



LENGTH = 3000 mm DEPTH = 750 mm (27x27 Eh)

SERIES WORK-SYSTEM 30-75

WORKTOP DIMENSIONS 3000x750x40 mm



ORD. NO.	TYPE OF WORKTOP	THICKNESS mm	LOAD CAPACITY kg
F BR 2245 01 51	Multiplex	40	2000

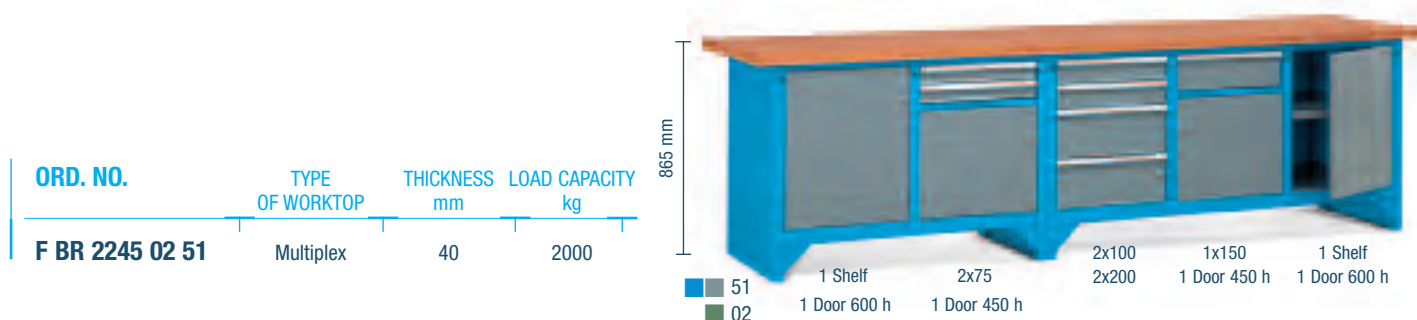

ORD. NO.	TYPE OF WORKTOP	THICKNESS mm	LOAD CAPACITY kg
F BR 2245 02 51	Multiplex	40	2000

WORKSTATION

ORD. NO.

F BR 2245 S1 51

Complete with multi-purpose back panels

Dimensions mm 3000x750x865/2130 h

Tools and sets of partitioning material for drawers excluded



KEY



- Worktop dimensions mm 3000x750x40 h
- Unit dimensions mm 1135x630x825 h + 1683x630x825 h
- All indicated loads are net and refer to evenly distributed weights

■ Set of partitions see page A19

■ RAL 5012
■ RAL 7000 F.51 ■ RAL 6011 F.02



SERIES WORK-SYSTEM

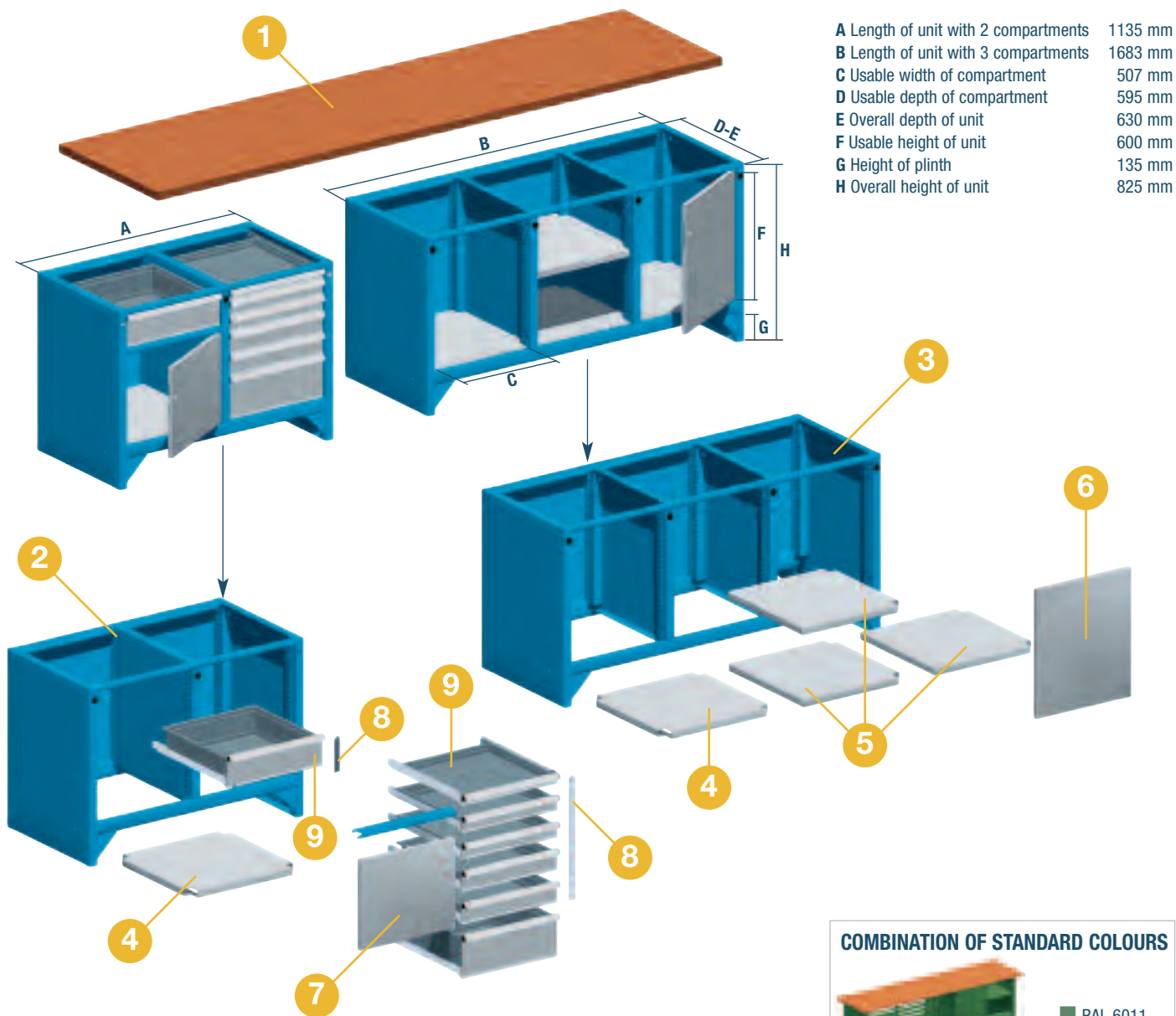

- A Length of unit with 2 compartments 1135 mm
- B Length of unit with 3 compartments 1683 mm
- C Usable width of compartment 507 mm
- D Usable depth of compartment 595 mm
- E Overall depth of unit 630 mm
- F Usable height of unit 600 mm
- G Height of plinth 135 mm
- H Overall height of unit 825 mm

COMBINATION OF STANDARD COLOURS

- RAL 6011
- RAL 5012 + RAL 7000

LOAD CAPACITY OF THE WORKTOP OF THE MODULAR WORKSTATIONS

Workstation layout

TYPE OF WORKTOP	THICKNESS mm	1000 kg	1000 kg	2000 kg	2000 kg
Multiplex	40	1000 kg	1000 kg	2000 kg	2000 kg
Steel	40	1000 kg	1000 kg	-	-

■ RAL 5012
■ RAL 7000 F.51 ■ RAL 6011 F.02



KEY ■

■ All indicated loads are net and refer to evenly distributed weights

DEPTH = 630 mm (27x27 Eh)

SERIES WORK-SYSTEM

1 MULTIPLEX SHELF 750 mm DEEP 40 mm THICKNESS

SHELF LENGTH	ORD. NO. MULTIPLEX SHELF	ORD. NO. PRE-DRILLINGS	FOR:
1500	F BI A242 00 00	1 pc F BR 0960 00 00	1 unit with 2 compartments
2000	F BI A270 00 00	1 pc F BR 0961 00 00	1 unit with 3 compartments
2500	F BI A284 00 00	2 pcs F BR 0960 00 00	2 units with 2 compartments
3000	F BI A298 00 00	+ 1 pc F BR 0960 00 00 + 1 pc F BR 0961 00 00	+ 1 unit with 2 compartments + 1 unit with 3 compartments

■ For other wooden worktops see page C2 - C3

1 STEEL SHELF 750 mm DEEP 40 mm THICKNESS

SHELF LENGTH	ORD. NO. MULTIPLEX SHELF	ORD. NO. MULTIPLEX SHELF	ORD. NO. PRE-DRILLINGS	FOR:
1500	■ RAL 7000 F BR 0020 00 01	■ RAL 6011 F BR 0020 00 02	1 pc F BR 0950 00 00	1 unit with 2 compartments
2000	■ RAL 7000 F BR 0030 00 01	■ RAL 6011 F BR 0030 00 02	1 pc F BR 0951 00 00	1 unit with 3 compartments

2 UNIT WITH 2 COMPARTMENTS DIM. mm 1135x630x825 h

ORD. NO.
■ RAL 5012 F BR 2242 00 04
■ RAL 6011 F BR 2242 00 02

3 UNIT WITH 3 COMPARTMENTS DIM. mm 1683x630x825 h

ORD. NO.
■ RAL 5012 F BR 2243 00 04
■ RAL 6011 F BR 2243 00 02

4 LEFT-HAND STEEL SHELVES
DIMENSIONS mm 579x566x35 h

ORD. NO.
■ RAL 7000 F BR 0220 01 01
■ RAL 6011 F BR 0220 01 02

This shelf is used as a bottom or an adjustable shelf for the **left-hand compartments of each unit**

Shelf load capacity: 50 kg

5 CENTRAL OR RIGHT-HAND STEEL SHELVES
DIMENSIONS mm 543x566x35 h

ORD. NO.
■ RAL 7000 F BR 0230 01 01
■ RAL 6011 F BR 0230 01 02

This shelf is used as a bottom or an adjustable shelf for the **central or the right-hand compartments of each unit**

Shelf load capacity: 50 kg

6 DOORS DIMENSIONS mm 504x598 h

ORD. NO. right door	ORD. NO. left door
■ RAL 7000 F BR 0720 00 01	■ RAL 7000 F BR 0721 00 01
■ RAL 6011 F BR 0720 00 02	■ RAL 6011 F BR 0721 00 02

This door is available with right and left-hand openings. It is **600 mm** high and completely covers a compartment. Supplied standard with cylinder lock and two keys.

7 DOORS DIMENSIONS mm 504x420 h

ORD. NO. right door	ORD. NO. left door
■ RAL 7000 F BR 0710 00 51	■ RAL 7000 F BR 0711 00 51
■ RAL 6011 F BR 0710 00 02	■ RAL 6011 F BR 0711 00 02

This door is available with right and left-hand openings. It partially covers a compartment up to a height of 450 mm. A shelf or drawers must be fitted over the door.

Supplied standard with cylinder lock and two keys.

8 150 – 600 mm HIGH LOCKING BARS FOR DRAWERS

ORD. NO. length 150 mm	ORD. NO. length 600 mm
F BR 0410 00 00	F BR 0430 00 00

These locking systems include a 150 mm or 600 mm locking bar and a cylinder lock with two keys.

9 DRAWERS

ORD. NO.	FRONT HEIGHT mm	LOAD CAPACITY kg	USABLE DIMENSIONS mm
F DB 8050 00 04	50	50	447x447x36 h
F DB 8075 00 04	75	70	447x447x61 h
F DB 8100 00 04	100	70	447x447x86 h
F DB 8125 00 04	125	70	447x447x111 h
F DB 8150 00 04	150	70	447x447x136 h
F DB 8200 00 04	200	70	447x447x186 h
F DB 8250 00 04	250	70	447x447x236 h
F DB 8300 00 04	300	70	447x447x286 h

Extension 100%



SERIES WORK-LOOK 10



ORD. NO. F BH A328 S3 04
RAL 5012

WORKSTATION**ORD. NO.****F BH A328 S3 04****Dimensions mm 1300x800x840/2110 h**

Tools, boxes and electrical equipment excluded

RAL 7000 F.01

RAL 6011 F.02

RAL 5012 F.04

RAL 7035 F.08

INFO ■

■ Set of hooks
see page **C66**

www.famispa.com



LENGTH = 1000 mm

SERIES WORK-LOOK 10

ORD. NO. BACK PANEL FOR

F BL A010 03 04 Wood

- 2 support columns 632 mm h
 - 2 perforated back panels 972x304 mm h
- Tools, hooks and boxes excluded

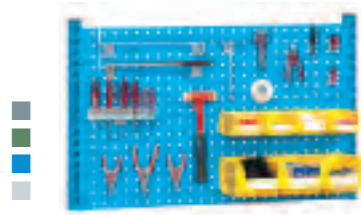

ORD. NO. BACK PANEL FOR

F BL A110 05 04 Wood

- 2 support columns 632 mm h, 1 shelf 955x220 mm
 - 1 perforated back panel 972x304 mm h
 - 1 multiple socket box with cabling complete with 5 Schuko sockets and thermomagnetic switch 2P 230V AC 10A I Δ N=0,01A
 - 1 swivel arm with two joints complete with practibox
- Tools, hooks and boxes excluded

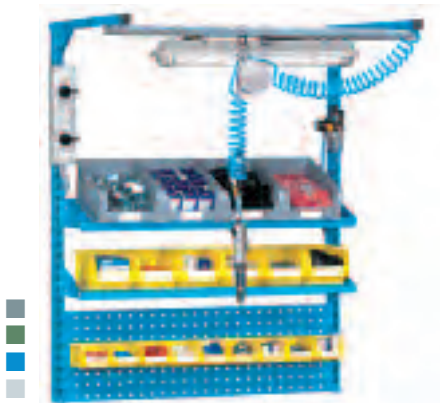

ORD. NO. BACK PANEL FOR

F BL A010 04 04 Wood

- 2 support columns 936 mm
 - 3 perforated back panels 972x304 mm
- Tools, hooks and boxes excluded

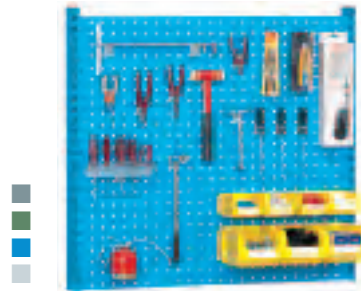

ORD. NO. BACK PANEL FOR

F BL A110 09 04 Wood

- 2 support columns 1240 mm h, 1 shelf 955x220 mm
 - 1 shelf 955x320 mm, 1 perforated back panel 972x304 mm h
 - 1 pair of carrier arms with aluminium slide track
 - 1 additional aluminium slide track, 1 2x18W Philips lamp
 - 1 pneumatic system
 - 1 multiple socket box with cabling complete with 5 Schuko sockets and thermomagnetic switch 2P 230V AC 10A I Δ N=0,01A
- Tools and boxes excluded



ORD. NO. BACK PANEL FOR

F BL A110 10 04 Wood

- 2 support columns 1240 mm h, 1 plain back panel 972x304 mm h
 - 2 shelves 955x420 mm
 - 1 pair of carrier arms with aluminium slide track
 - 1 2x36W Waldmann lamp
 - 1 multiple socket box with cabling complete with 5 Schuko sockets and thermomagnetic switch 2P 230V AC 10A I Δ N=0,01A
 - 1 monitor arm load capacity 13 kg
- Tools excluded

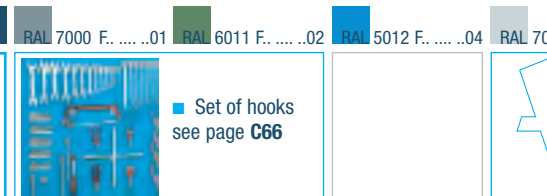

■ INFO

RAL 7000 F.01 RAL 6011 F.02 RAL 5012 F.04 RAL 7035 F.08

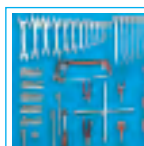

■ Set of hooks see page C66

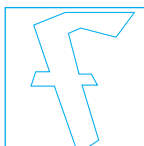

www.famispa.com



ORD. NO. F BH A342 S2 04
RAL 5012

WORKSTATION

ORD. NO.

F BH A342 S2 04

Dim. mm 1500x800x840/2110 h

Tools and drawer partitioning set
excluded

RAL 7000 F.01

RAL 6011 F.02

RAL 5012 F.04

RAL 7035 F.08

INFO ■



■ Set of hooks
see page C66

www.famispa.com



LENGTH = 1500 mm

SERIES WORK-LOOK 15

ORD. NO. BACK PANEL FOR

F BL A015 01 07 Wood
 2 height-adjustable shelves brackets 215-335 mm h
 1 shelf of multiplex 1500x300x20 mm h
 Tools and boxes excluded

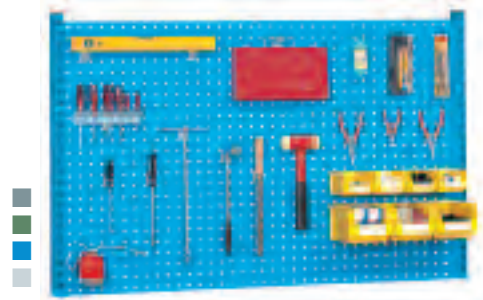
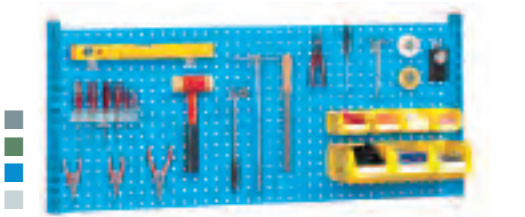

ORD. NO. BACK PANEL FOR

F BL A015 06 04 Wood
F BL B015 06 04 Steel
 2 support columns 632 mm h
 2 perforated back panels 1457x304 mm h
 Tools, hooks and boxes excluded

ORD. NO. BACK PANEL FOR

F BL A015 07 04 Wood
 2 support columns 936 mm h
 3 perforated back panels 1457x304 mm h
 Tools, hooks and boxes excluded

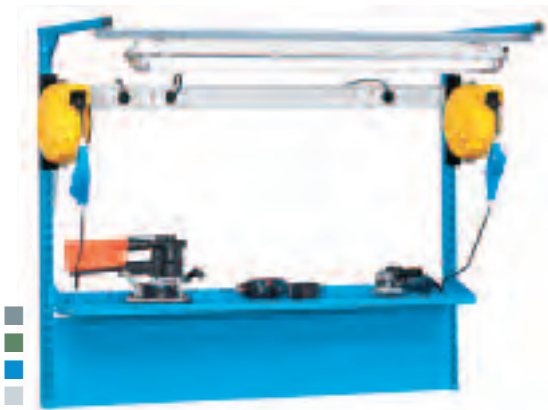

ORD. NO. BACK PANEL FOR

F BL A115 09 04 Wood
 2 support columns 1240 mm h, 1 shelf 1440x320 mm
 1 plain back panel 1457x304 mm h
 1 pair of carrier arms with aluminium slide track
 1 power panelling with cabling complete with 9 Schuko sockets and thermomagnetic switch 2P 230V AC 10A | Δ N=0,01A
 1 pair of supports for rear power panelling
 2 230V winders with 10 metres of cable 3x1,5 mm²
 1 heavy duty flying socket 220-250 V 16A 2P+GND and
 1 Schuko socket 220-250V 16A 2P+GND
 1 2x36W Philips lamp
 Tools excluded

ORD. NO. BACK PANEL FOR

F BL A115 14 04 Wood
 2 support columns 1240 mm h
 1 shelf 1440x320 mm
 1 perforated back panel 1457x304 mm h
 1 pair of carrier arms with aluminium slide track
 1 additional aluminium slide track
 1 2x36W Philips lamp
 1 pneumatic system
 1 multiple socket box with cabling complete with 5 Schuko sockets and thermomagnetic switch 2P 230V AC 10A | Δ N=0,01A
 1 swivel arm with two joints complete with practibox
 Tools, hooks and boxes excluded

INFO

RAL 7000 F.01 RAL 6011 F.02 RAL 5012 F.04 RAL 7035 F.08



www.famispa.com

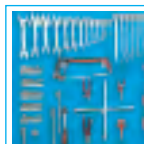

■ Set of hooks
 see page C66

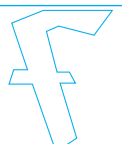

SERIES WORK-LOOK 20

LENGTH = 2000 mm



RAL 7000 F.01

RAL 6011 F.02

RAL 5012 F.04

RAL 7035 F.08

INFO ■

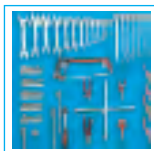
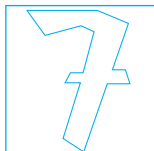

■ Set of hooks
see page C66

www.famispa.com



LENGTH = 2000 mm

SERIES WORK-LOOK 20

ORD. NO. BACK PANEL FOR

F BL A020 01 07 Wood
 2 height-adjustable shelves brackets 215-335 mm h
 1 shelf in multiplex 2000x300x20 mm h
 Tools and boxes excluded

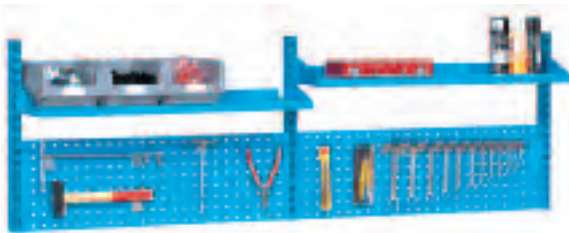

ORD. NO. BACK PANEL FOR

F BL A020 05 04 Wood
F BL B020 05 04 Steel
 3 support columns 632 mm h, 2 shelves 955x320 mm
 2 perforated back panels 972x304 mm h
 Tools, hooks and boxes excluded

ORD. NO. BACK PANEL FOR

F BL A020 07 04 Wood
F BL B020 07 04 Steel
 3 support columns 632 mm h
 4 perforated back panels 972x304 mm h
 Tools and hooks excluded

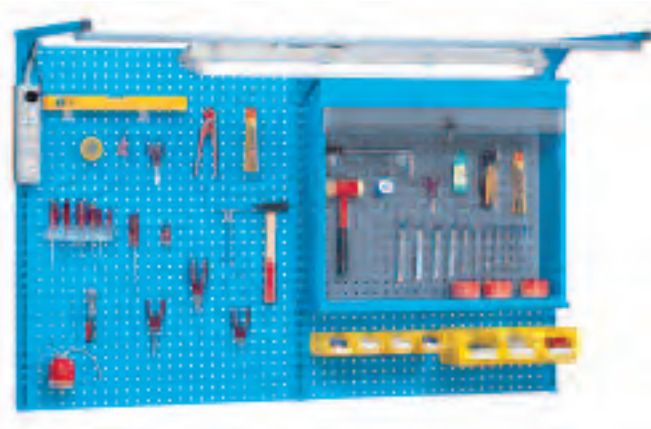

ORD. NO. BACK PANEL FOR

F BL A120 20 04 Wood
 3 support columns 1240 mm h
 5 perforated back panels 972x304 mm h
 1 carrier arm assembly with aluminium slide track
 1 roller shutter cabinet
 1 multiple socket box with cabling complete with 5 Schuko sockets and thermomagnetic switch 2P 230V AC 10A I Δ N=0,01A
 1 2x36W Philips lamp
 Tools, hooks and boxes excluded

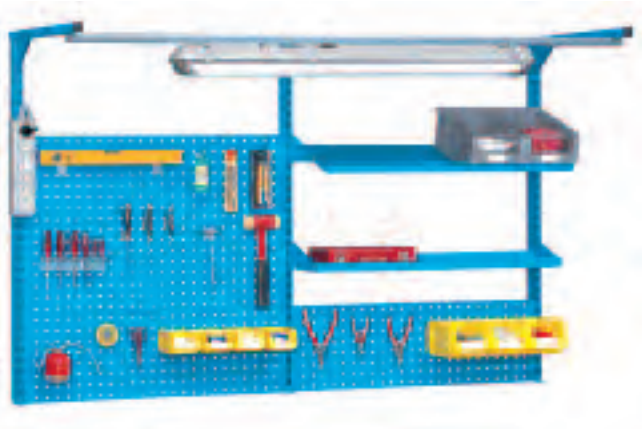

ORD. NO. BACK PANEL FOR

F BL A120 13 04 Wood
 3 support columns 1240 mm h
 1 shelf 955x220 mm, 1 shelf 955x320 mm
 4 perforated back panels 972x304 mm h
 1 carrier arm assembly with aluminium slide track
 1 2x36W Philips lamp
 1 multiple socket box with cabling complete with 5 Schuko sockets and thermomagnetic switch 2P 230V AC 10A I Δ N=0,01A
 Tools, hooks and boxes excluded

INFO

RAL 7000 F.01 RAL 6011 F.02 RAL 5012 F.04 RAL 7035 F.08



www.famispa.com

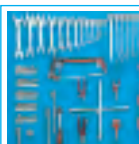

■ Set of hooks
 see page C66

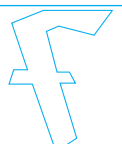

SERIES WORK-LOOK 25



ORD. NO. F BK A584 S1 04
RAL 5012

WORKSTATION

ORD. NO.

F BK A584 S1 04

Dimensions mm 2500x800x850/2120 h

Tools excluded

RAL 7000 F.01

RAL 6011 F.02

RAL 5012 F.04

RAL 7035 F.08

INFO ■

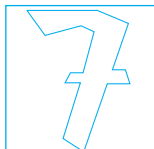

■ Set of hooks
see page C66

www.famispa.com



LENGTH = 2500

SERIES WORK-LOOK 25

ORD. NO.

BACK PANEL FOR

F BL A025 02 07

Wood

3 height-adjustable shelves brackets 215-335 mm h

1 shelf in multiplex 2500x300x20 mm h

Tools and boxes excluded



ORD. NO.

BACK PANEL FOR

F BL A025 06 04

Wood

3 support columns 632 mm h

1 shelf 1440x220 mm

1 shelf 955x220 mm

1 perforated back panel 972x304 mm h

1 perforated back panel 1457x304 mm h

Tools, hooks and boxes excluded

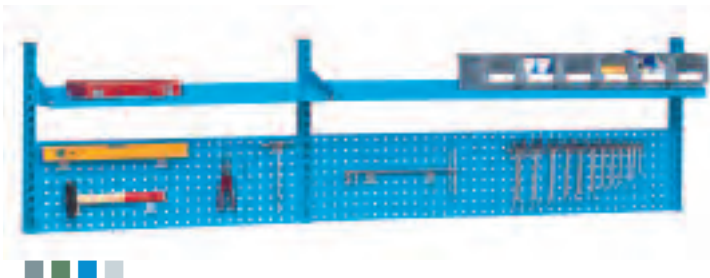

ORD. NO.

BACK PANEL FOR

F BL A025 08 04

Wood

3 support columns 936 mm h

3 perforated back panels 972x304 mm h

3 perforated back panels 1457x304 mm h

Tools, hooks and boxes excluded

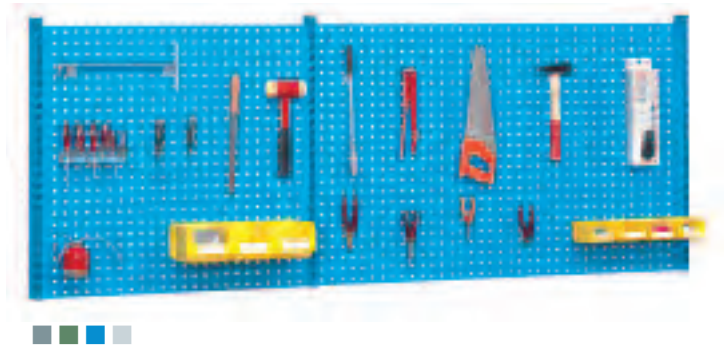

ORD. NO.

BACK PANEL FOR

ORD. NO.

F BL A125 11 04

Wood

3 support columns 1240 mm h

1 shelf 1440x320 mm

1 shelf 955x320 mm

1 shelf 1440x220 mm

2 perforated back panels 972x304 mm h

1 perforated back panel 1457x304 mm h

1 carrier arm assembly with aluminium slide track

1 2x36W Philips lamp

1 multiple socket box with cabling complete with 5 Schuko sockets and thermomagnetic switch 2P 230V AC 10A I Δ N=0,01A

Tools, hooks and boxes excluded

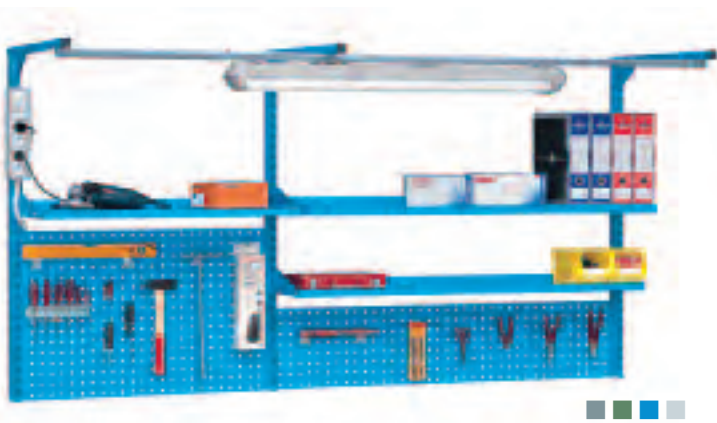

■ INFO

RAL 7000 F.01 RAL 6011 F.02 RAL 5012 F.04 RAL 7035 F.08

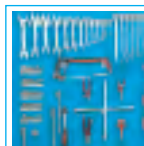

■ Set of hooks
see page C66

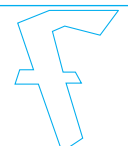

www.famispa.com

SERIES WORK-LOOK 30



ORD. NO. F BI A598 S2 04
RAL 5012

WORKSTATION**ORD. NO.****F BI A598 S2 04**

Dimensions mm 3000x800x850/2120 h

Tools excluded

RAL 7000 F.01

RAL 6011 F.02

RAL 5012 F.04

RAL 7035 F.08

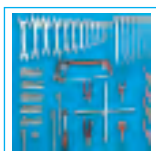
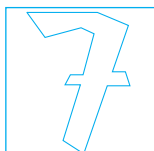
INFO ■

■ Set of hooks
see page C66

www.famispa.com



LENGTH = 3000 mm

SERIES WORK-LOOK 30

ORD. NO. BACK PANEL FOR

F BL A030 02 07 Wood
 3 height-adjustable shelves brackets 215-335 mm h
 1 shelf of multiplex 3000x300x20 mm h

Tools and boxes excluded



ORD. NO. BACK PANEL FOR

F BL A030 03 04 Wood
 3 support columns 632 mm h
 2 shelves 1440x220 mm
 2 shelves 1440x320 mm

Tools, hooks and boxes excluded

ORD. NO. BACK PANEL FOR

F BL A030 07 04 Wood
 3 support columns 632 mm h
 4 perforated back panels 1457x304 mm h

Tools, hooks and boxes excluded



ORD. NO. BACK PANEL FOR

F BL A130 11 04 Wood
 3 support columns 1240 mm h
 3 perforated back panels 1457x304 mm h
 2 shelves 1440x320 mm h
 1 carrier arm assembly with aluminium slide track
 1 2x36W Philips lamp
 1 pair of supports for rear power panelling
 1 power panelling with cabling complete with 9 Schuko sockets and thermomagnetic switch 2P 230V AC 10A I Δ N=0,001A

Tools, hooks and boxes excluded

■ INFO

RAL 7000 F.01 RAL 6011 F.02 RAL 5012 F.04 RAL 7035 F.08



www.famispa.com

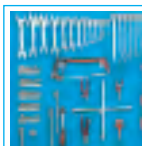

■ Set of hooks
 see page C66



SERIES WORK-LOOK

SET OF SUPPORT COLUMNS WITH BOTH SIDE DUAL SLOTS
FOR STEEL WORKTOPS LENGTH 1500 MM

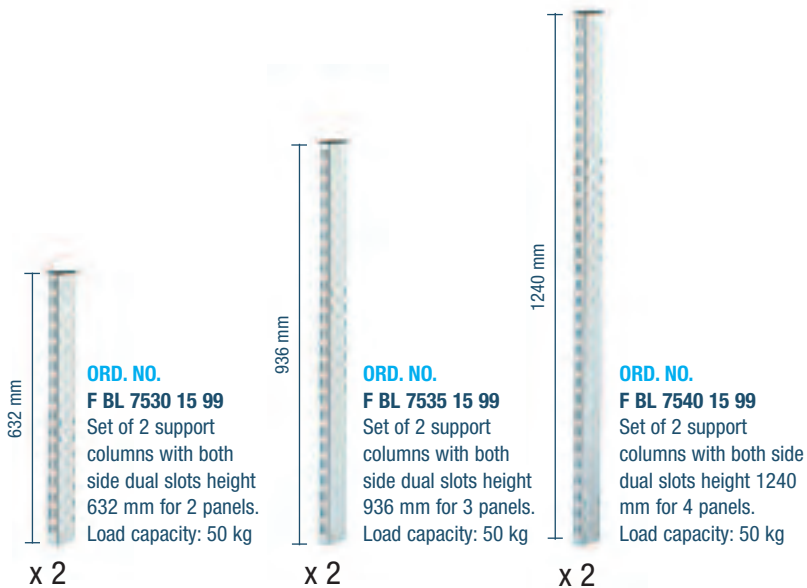

■ 01 ■ 02 ■ 04 ■ 08 ■ 99

SUPPORT COLUMNS WITH BOTH SIDE
DUAL SLOTS FOR WOODEN WORKTOPS

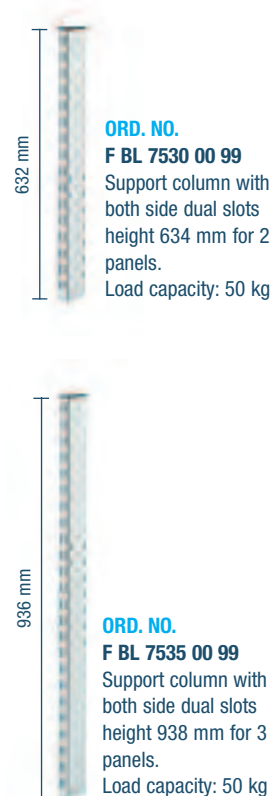

SET OF SUPPORT COLUMNS WITH BOTH SIDE DUAL SLOTS
FOR STEEL WORKTOPS LENGTH 2000 MM

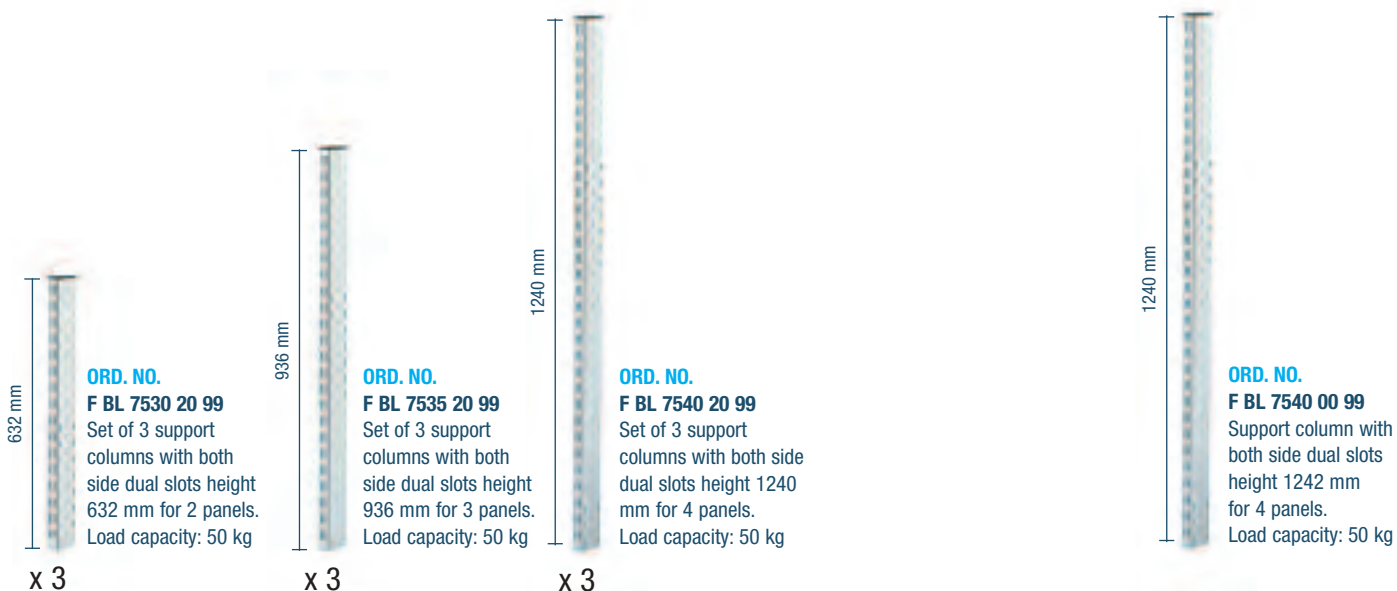

■ 01 ■ 02 ■ 04 ■ 08 ■ 99

■ 01 ■ 02 ■ 04 ■ 08 ■ 99

RAL 7000 F.01 RAL 6011 F.02 RAL 5012 F.04 RAL 7035 F.08

KEY ■

■ All indicated loads are net and refer to evenly distributed weights

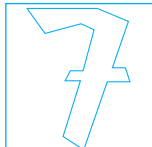
SHELF FOR MULTI-PURPOSE PANELS LENGTH 1000 mm



Height-adjustable tilting shelf in 2 positions with front or rear upstand

available in 3 dimensions:

955x220 mm 955x320 mm 955x420 mm

ORD. NO.	DEPTH OF SHELF mm	LOAD CAPACITY kg
F BL 7750 00 04	220	25
F BL 7755 00 04	320	25
F BL 7760 00 04	420	25
F BL 7762 00 04	600	25

■ 01 ■ 02 ■ 04 ■ 08 ■ 99

SHELF FOR MULTI-PURPOSE PANELS LENGTH 1500 mm



Height-adjustable tilting shelf in 2 positions with front or rear upstand

available in 3 dimensions:

1440x220 mm 1440x320 mm 1440x420 mm

ORD. NO.	DEPTH OF SHELF mm	LOAD CAPACITY kg
F BL 7795 00 04	220	25
F BL 7800 00 04	320	25
F BL 7805 00 04	420	25

■ 01 ■ 02 ■ 04 ■ 08 ■ 99

PERFORATED PANEL

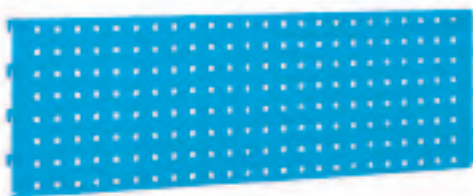

Perforated panel equipped for fixing the support columns with both side dual slots, available in two sizes:

973x304 mm h for length 1000 mm
1458x304 mm h for length 1500 mm

ORD. NO.	LENGTH OF PANEL mm	LOAD CAPACITY kg
F BL 7620 00 04	973	25
F BL 7635 00 04	1458	25

■ 01 ■ 02 ■ 04 ■ 08

PLAIN PANEL



Plain panel equipped for fixing the support columns with both side dual slots, available in two sizes:

973x304 mm h for length 1000 mm
1458x304 mm h for length 1500 mm

ORD. NO.	LENGTH OF PANEL mm
F BL 7670 00 04	973
F BL 7685 00 04	1458

■ 01 ■ 02 ■ 04 ■ 08

■ KEY

■ RAL 7000 F.01 ■ RAL 6011 F.02 ■ RAL 5012 F.04 ■ RAL 7035 F.08



■ All indicated loads are net and refer to evenly distributed weights

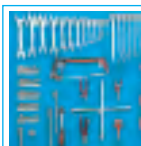

■ Set of hooks
see page C66



SERIES WORK-LOOK

PAIR OF CARRIER ARMS WITH ALUMINIUM SLIDE TRACK LENGTH 1000/1500 mm

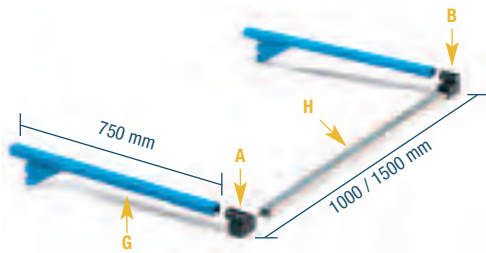

Pair of carrier arms with slide track depth **750 mm** for length **1000-1500 mm**. Includes 2 carrier arms (ref. G), 1 pair of plastic end connectors (ref. A+B) and 1 aluminium track (ref. H).

ORD. NO.	LENGTH OF SLIDE TRACK mm	LOAD CAPACITY kg
F BL 9810 01 54	1000	10
F BL 9815 01 54	1500	10

■ RAL 7000 + Aluminium F.52 ■ RAL 5012 + Aluminium F.54
 ■ RAL 6011 + Aluminium F.53 ■ RAL 7035 + Aluminium F.55

CARRIER ARMS ASSEMBLY WITH ALUMINIUM SLIDE TRACK LENGTH 2000/2500/3000 mm

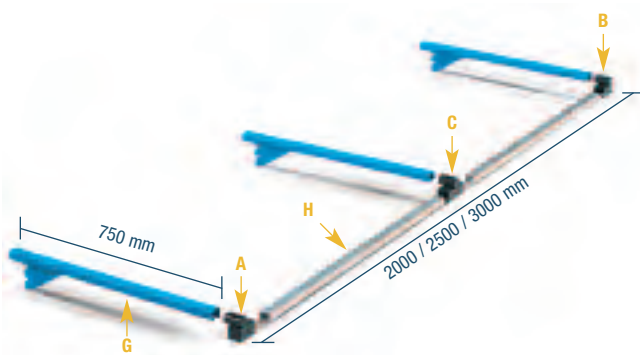

Carrier arms assembly with slide track depth **750 mm** for length **2000-2500-3000 mm**. Includes 3 carrier arms (ref. G), 1 pair of plastic end connectors (ref. A+B), 1 plastic junction connector (ref. C) and 2 aluminium tracks (ref. H).

ORD. NO.	LENGTH OF SLIDE TRACK mm	LOAD CAPACITY kg
F BL 9820 01 54	2000	10
F BL 9825 01 54	2500	10
F BL 9830 01 54	3000	10

■ RAL 7000 + Aluminium F.52 ■ RAL 5012 + Aluminium F.54
 ■ RAL 6011 + Aluminium F.53 ■ RAL 7035 + Aluminium F.55



■ RAL 7035

WORKSTATION

ORD. NO.

F BH A370 S2 08

Dimensions mm 2000x800x840/2110 h

Tools and boxes excluded

CARRIER ARMS ASSEMBLY WITH ALUMINIUM SLIDE TRACK LENGTH 3000 mm

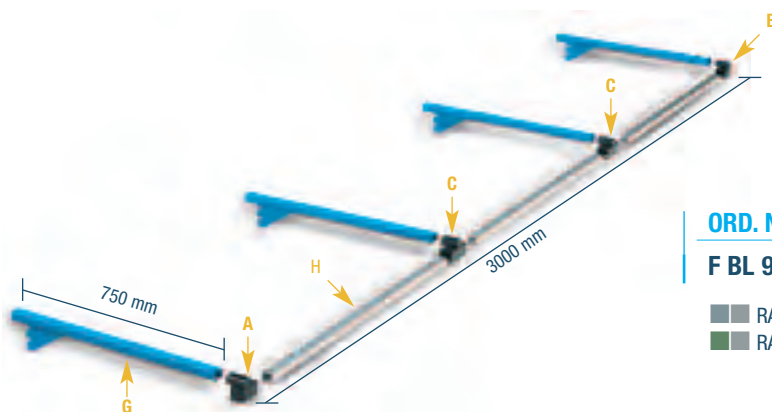

Carrier arms assembly with slide track depth **750 mm** for length **3000 mm**. Includes 4 carrier arms (ref. G), 1 pair of plastic end connectors (ref. A+B), 2 plastic junction connectors (ref. C) and 3 aluminium tracks (ref. H).

ORD. NO.	LENGTH OF SLIDE TRACK mm	LOAD CAPACITY kg
F BL 9830 02 54	3000	10

■ RAL 7000 + Aluminium F.52 ■ RAL 5012 + Aluminium F.54
 ■ RAL 6011 + Aluminium F.53 ■ RAL 7035 + Aluminium F.55

ADDITIONAL ALUMINIUM SLIDE TRACK WITH CONNECTORS

Additional aluminium slide track with connectors.
The slide tracks with length 2000-2500- 3000 are supplied in various sections.



ORD. NO.	LENGTH OF SLIDE TRACK mm
F BL 9810 10 00	1020
F BL 9815 10 00	1500
F BL 9820 10 00	2000
F BL 9825 10 00	2500
F BL 9830 10 00	3000*
F BL 9830 11 00	3000**

*additional alumin. slide track for assembly with 3 supports
**additional alumin. slide track for assembly with 4 supports

CONNECTORS

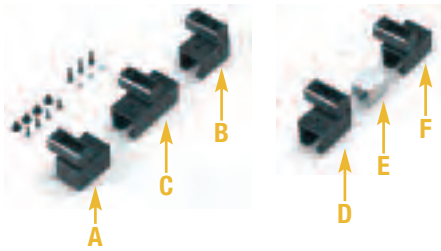

ORD. NO.	REFERENCE
F BL 9841 00 07	A+B
F BL 9840 00 07	C
F BL 9842 00 07	D+E+F

The set of connectors (ref. D+E+F) is used when the tracks of several workstations have to be joined together for the transit of the trolley. The slide track (ref. E) is 60 mm in length.

ROLLER SHUTTER CABINET

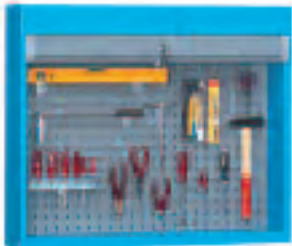

ORD. NO.	FIXING TYPE	CYLINDER LOCK	LOAD CAPACITY kg
F BL 7011 01 51	to the wall	series 45	50
F BL 7011 02 51	to the support columns	series 45	50
F BL 7011 03 51	to the wooden worktops	series 45	50
Overall dimensions mm 952x210x810 h			
Usable dimensions mm 905x150x581 h			

Hooks and tools excluded

■ 01 ■ 02 ■ 51 ■ 56



ORD. NO.	FIXING TYPE	CYLINDER LOCK	LOAD CAPACITY kg
F BL 7021 01 51	to the wall	series 45	50
F BL 7021 03 51	to the wooden worktops	series 45	50
Overall dimensions mm 952x210x1115 h			
Usable dimensions mm 905x150x885 h			

Hooks and tools excluded

■ 01 ■ 02 ■ 51 ■ 56

WINDER



ORD. NO. F BL 9601 01 07

IP42 230V winder with 10 metres of cable 3x1,5 mm² complete with a heavy duty flying socket 220-250V 16A 2P+GND and a Schuko socket 220-250V 10A 2P+GND. The winder is fitted with a bracket for connection to the support columns with dual slots.

Power output:

with cable wound up 1200W
with cable unwound 1800W



SERIES WORK-LOOK

PHILIPS LAMP IP 66

Structure: Casing in polyester, cover in transparent polycarbonate

■ 08



2x18 W

ORD. NO.	DIMENSIONS mm
F BL 9905 00 00	700x140x85 h
Fixing material included	

Technical specifications of lamp:

Protected to:	IP 66	Length of cable:	4 metres
Neon:	2x18W	Tonality:	4000K
Electrical input:	230V/50Hz	Colour rendering (Ra):	80-89
Plug:	Schuko		

Structure: Casing in polyester, cover in transparent polycarbonate

■ 08

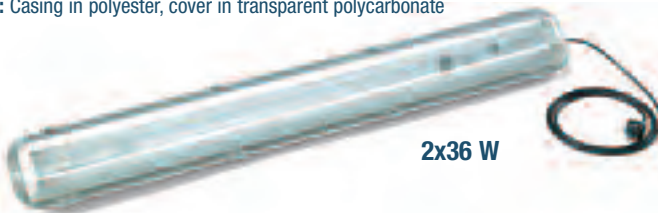

2x36 W

ORD. NO.	DIMENSIONS mm
F BL 9910 00 00	1300x165x95 h
Fixing material included	

Technical specifications of lamp:

Protected to:	IP 66	Length of cable:	4 metres
Neon:	2x36W	Tonality:	4000K
Electrical input:	230V/50Hz	Colour rendering (Ra):	80-89
Plug:	Schuko		

Structure: Casing in polyester, cover in transparent polycarbonate

■ 08

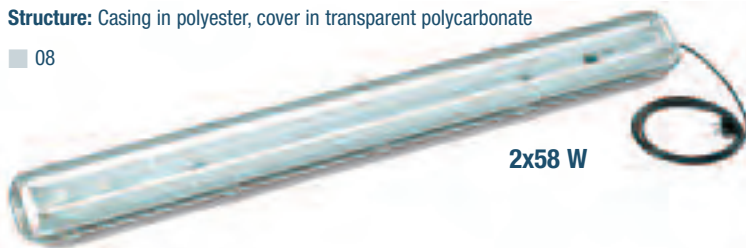

2x58 W

ORD. NO.	DIMENSIONS mm
F BL 9915 00 00	1600x165x95 h
Fixing material included	

Technical specifications of lamp:

Protected to:	IP 66	Length of cable:	4 metres
Neon:	2x58W	Tonality:	4000K
Electrical input:	230V/50Hz	Colour rendering (Ra):	80-89
Plug:	Schuko		

ANTI-GLARE HOOD FOR PHILIPS LAMP

■ 08



ORD. NO.	FOR LAMP
F BL 9921 00 08	2x18 W
F BL 9922 00 08	2x36 W

WALDMANN LAMP 2x36 W IP 67

Structure: Glass tube, parabolic diffuser

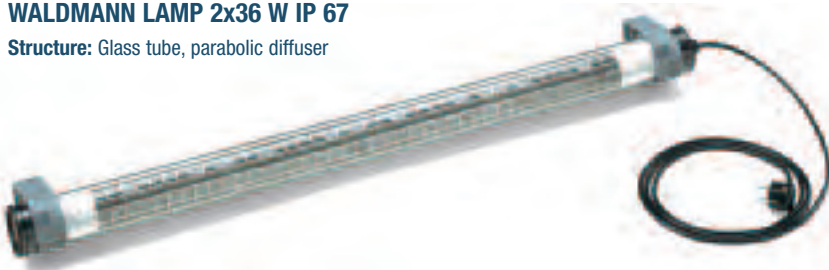

ORD. NO.	DIAMETER mm	LENGTH mm
F BL 9960 00 00	70	1090
Fixing material included		

Technical specifications of lamp:

Protected to:	IP 67	Length of cable:	4 m
Neon:	2x36W	Tonality:	4000K
Electrical input:	230V/50Hz	Colour rendering (Ra):	80-89
Plug:	Schuko		

WALDMANN LAMP 2x36 W IP 20

Structure: Casing in aluminium, metallic parabolic diffuser

■ 08

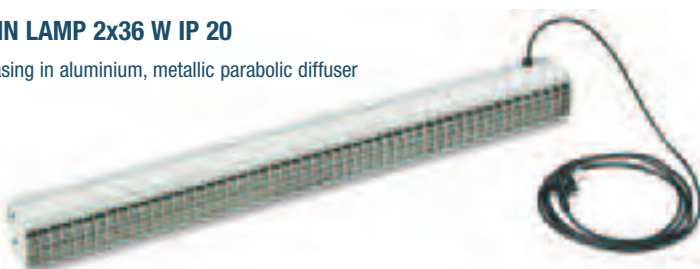

ORD. NO.	DIMENSIONS mm
F BL 9930 00 08	910x90x105 h
Fixing material included	

Technical specifications of lamp:

Protected to:	IP 20	Length of cable:	2,95 m
Neon:	2x36W	Tonality:	4000K
Electrical input:	230V/50Hz	Colour rendering (Ra):	80-89
Plug:	Schuko		



■ RAL 5012

WORKSTATION

ORD. NO.

F BI A528 S3 04

Dimensions mm 1300x800x850/2120 h

Tools and boxes excluded

TRIPLE-JOINTED WALDMANN LAMP 1x36 W IP 20

Structure: Casing in aluminium, metallic parabolic diffuser

■ 08

ORD. NO. F BL 9980 00 08

The standard lighting system includes:

1 multi-purpose steel support for fixing the lamp

1 clamp 0–65 mm

1 triple-jointed lamp

Technical specifications of lamp:

Protected to:	IP 20	Length of cable:	1,95 m
Neon:	1x36W	Tonality:	4000K
Electrical input:	230V/50Hz	Colour rendering (Ra):	80-89
Plug:	Schuko		

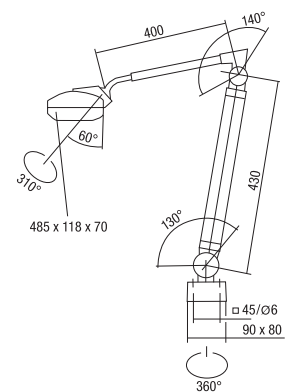

The multi-purpose steel support (supplied standard with the lamp) is used to fix the lamp to the support column with dual slots.



■ RAL 5012

WORKSTATION

ORD. NO. F BH A328 S3 04

Dimensions mm 1300x800x840/2110 h

Tools, boxes and electrical equipment excluded



■ RAL 5012

WORKSTATION

ORD. NO. F BH A342 S2 04

Dimensions mm 1500x800x840/2110 h

Tools and sets of partitioning material for drawers excluded

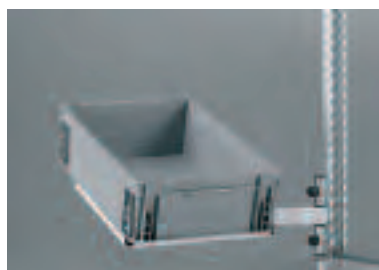
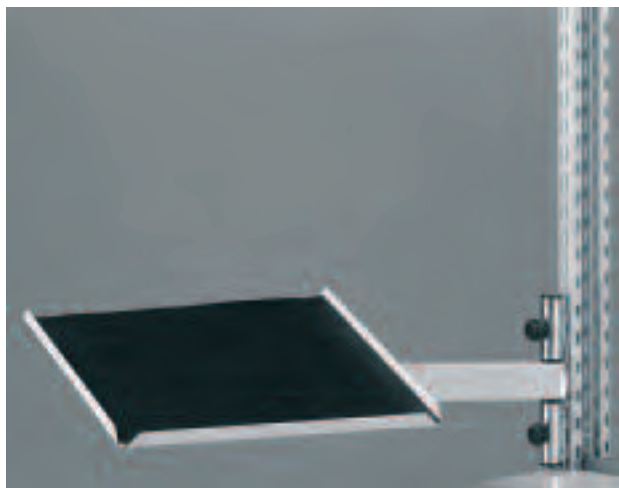
**SWIVEL ARM WITH TWO JOINTS WITH INCLINED TRAY****ORD. NO.****F BL 7456 00 08**

Complete with screw brakes with knob

Internal dim. of tray 401x402x21 mm h

**SWIVEL ARM WITH TWO JOINTS WITH BOXES****ORD. NO.****F BL 7445 03 08**Complete with 5 grey boxes size 1 and
3 grey boxes size 2

Load capacity 15 kg

**SWIVEL ARM WITH TWO JOINTS WITH BOXES****ORD. NO.****F BL 7445 04 08**

Complete with 15 grey boxes size 1

Load capacity 15 kg

**SWIVEL ARM WITH TWO JOINTS WITH TRAY****ORD. NO.****F BL 7455 00 08**

Complete with screw brakes with knob

Load capacity 20 kg

**SWIVEL ARM WITH TWO JOINTS WITH PRACTIBOX****ORD. NO.****F BL 7446 01 08**Complete with 1 practibox drawer unit with 9 drawers and
2 practibox drawer units with 6 drawers

Load capacity 15 kg

RAL 7000 F.01 RAL 6011 F.02 RAL 5012 F.04 RAL 7035 F.08

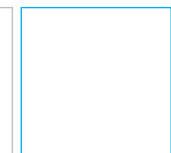
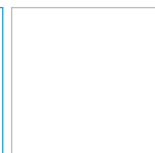
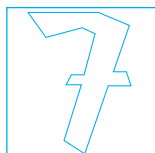
KEY ■

■ All indicated loads are net and refer to evenly distributed weights





■ Power panelling see page D74



■ Multiple socket box see page D75



■ Pneumatic system see page D71

■ INFO



www.famispa.com

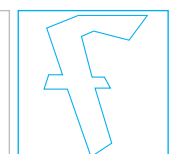
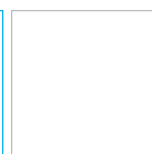

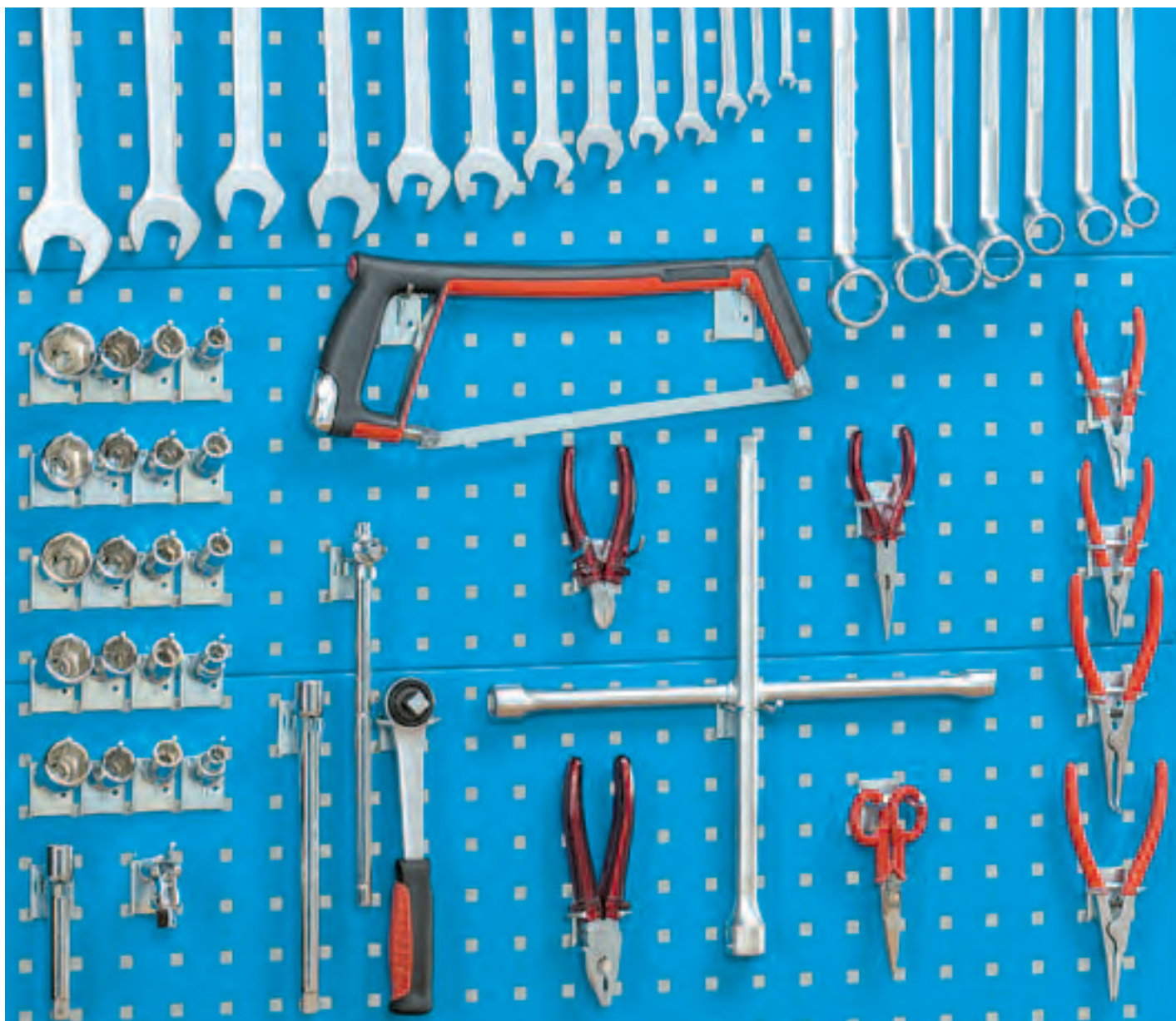

SET OF HOOKS AND BOXES

■ 01 ■ 02 ■ 03 ■ 04 ■ 05

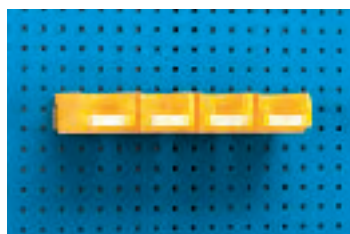
**ORD. NO. F BL 9504 00 05**

Set of 4 boxes size 1
complete with bracket for connection
to the perforated back panels
Dimensions mm 450x160x75 h

**ORD. NO. F BL 9507 00 05**

Set of 3 boxes size 2
complete with bracket for connection
to the perforated back panels
Dimensions mm 450x230x130 h

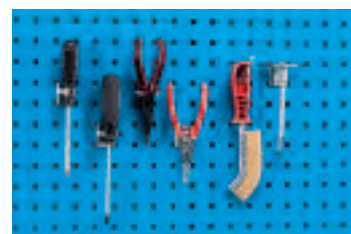
**ORD. NO. F BL 9508 00 99**

Set of 6 hooks (tools excluded)
including:

no. 2 **C MV 10 022**, no. 1 **C MV 10 003**
no. 1 **C MV 10 036**, no. 2 **C MV 10 001**

GREY PL
F.01

GREEN PL
F.02

RED PL
F.03

BLUE PL
F.04

YELLOW PL
F.05

INFO ■



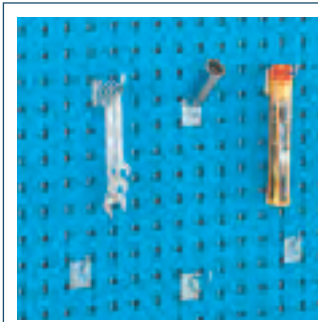

SINGLE HOOK

ORD. NO.	Ø	L
C MV 10 035	6	10
C MV 10 036	6	50

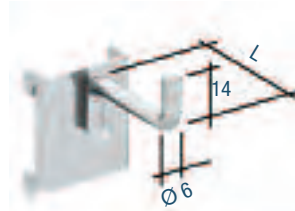

99



FLEXIBLE HOOK

ORD. NO.	L	B
C MV 10 002	28	9
C MV 10 003	33	17

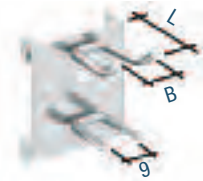

99

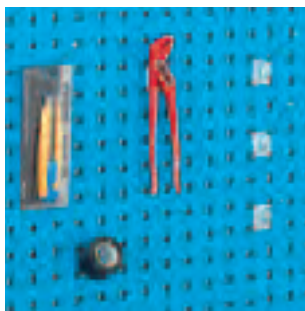

ANGLE SINGLE HOOK

ORD. NO.	Ø	L
C MV 10 014	4	50
C MV 10 015	6	100

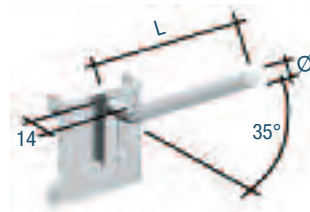

99



ROUND HOOK

ORD. NO.	Ø
C MV 10 030	60
C MV 10 032	80



99



ANGLE HOOK

ORD. NO.	Ø	L	B
C MV 10 016	5	50	40



99

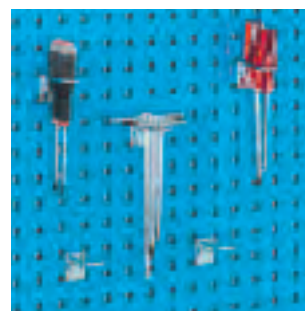

CLOSED DOUBLE HOOK

ORD. NO.	Ø	L	B
C MV 10 004	5	70	25



99

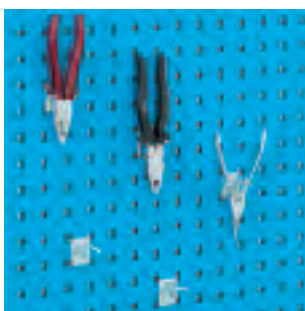

LEVEL HOOK

ORD. NO.	Ø	L	B
C MV 10 001	5	20	43



99

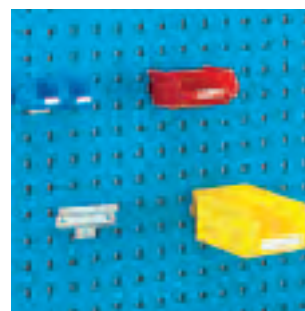

**HOOK FOR BOXES
SIZE 01 - 0 - 1**

ORD. NO.	A	L	B
C MV 10 026	9	9	40

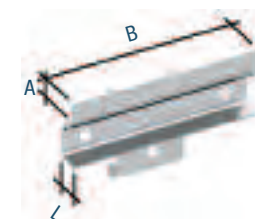

99

■ INFO

GALVANISED F.....99



www.famispa.com

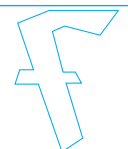

SERIES WORK-LOOK

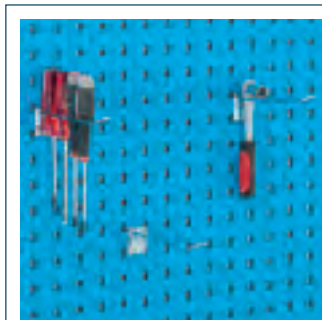

FIXING CLAMP

ORD. NO.	Ø	L	B
C MV 10 027	3,5	170	29

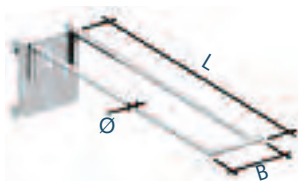

■ 99

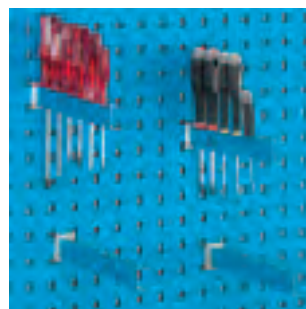

SCREW DRIVER HOOK

ORD. NO.	Ø	L	B
C MV 10 018	12	220	32



■ 99

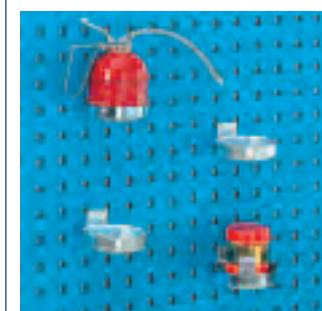

CONTAINER HOOK

ORD. NO.	Ø	L
C MV 10 017	82	30



■ 99

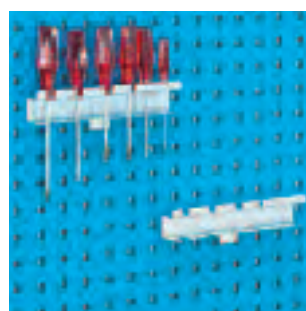

SPRING CLIP

ORD. NO.	L	B
C MV 10 019	238	40

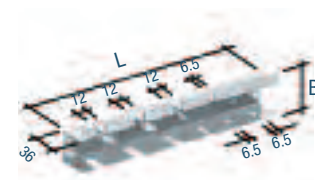

■ 99

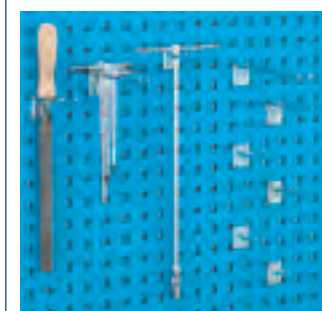

DOUBLE HOOK

ORD. NO.	Ø	L	B
C MV 10 005	5	38	7
C MV 10 006	5	38	11
C MV 10 007	5	55	25
C MV 10 008	5	64	7
C MV 10 009	5	64	11
C MV 10 010	5	100	25
C MV 10 011	5	150	10
C MV 10 012	5	150	25
C MV 10 013	5	200	15

■ 99



SUSPENSION HOOK

ORD. NO.	Ø	L
C MV 10 037	5	24
C MV 10 038	5	38
C MV 10 039	4	100
C MV 10 040	6	100
C MV 10 041	5	150
C MV 10 042	6	200

■ 99

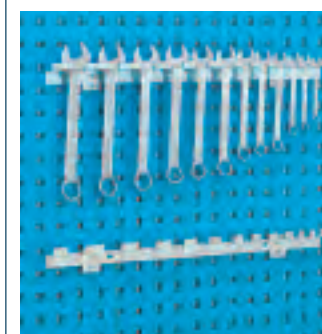
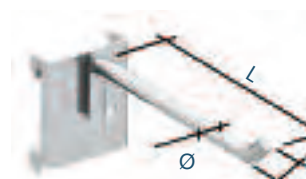

KEY HOOK

ORD. NO.	L
C MV 10 025	556

■ 99

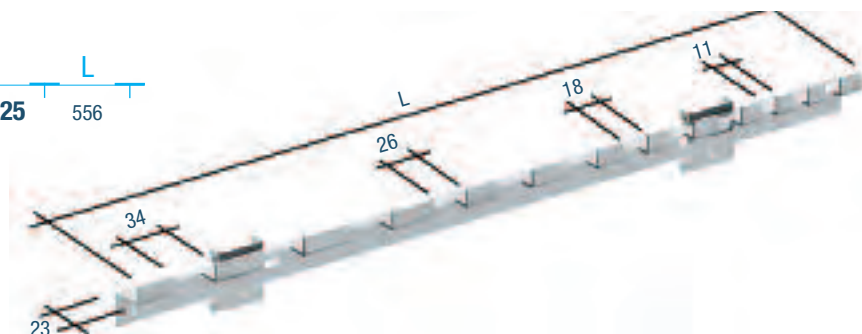

GALVANISED F... ..99

INFO ■

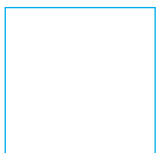
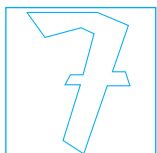

www.famispa.com

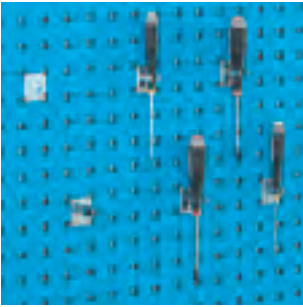

SPRING CLIP

ORD. NO.	Ø
C MV 10 020	6
C MV 10 021	12
C MV 10 022	18
C MV 10 023	25



99



CLOSED FLEXIBLE HOOK

ORD. NO.	Ø
C MV 10 029	40
C MV 10 031	60
C MV 10 033	80

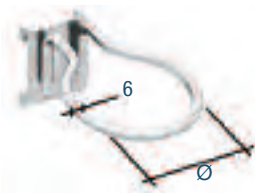

99

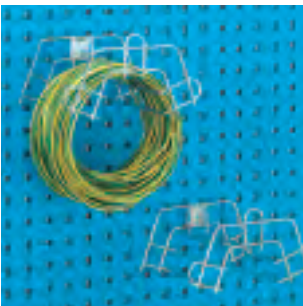

CABLE HOOK

ORD. NO.	L	B	Ø
C MV 10 024	160	125	5

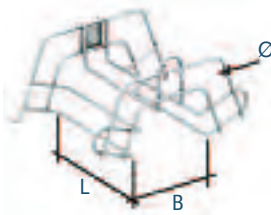

99

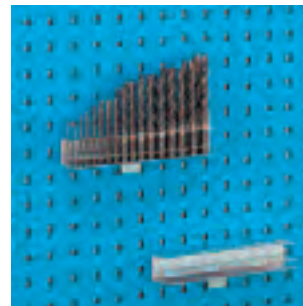

BIT HOOK

ORD. NO.	A	L	B
C MV 10 028	40	238	42,5



99



SHELF

ORD. NO.	A	L	B
C MV 10 043	10	350	120

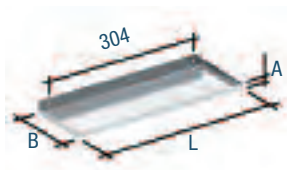

99

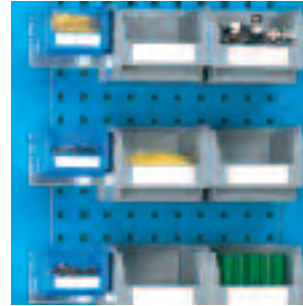

**CONTAINER'S RAIL
SIZE 1/ SIZE 2**

ORD. NO.	A	L	B
F BL 7438 00 99	86	445	-



99

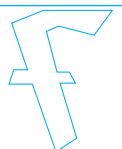

SERIES WORK-LOOK

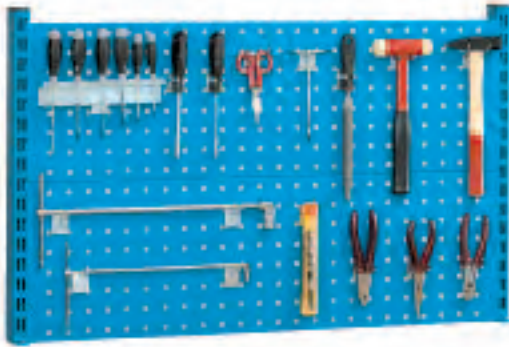

■ 01
■ 02
■ 04
■ 08

Including:

no. 1 **C MV 10 019**
no. 3 **C MV 10 001**
no. 3 **C MV 10 022**
no. 1 **C MV 10 003**
no. 1 **C MV 10 007**
no. 2 **C MV 10 016**
no. 4 **C MV 10 036**
no. 1 **C MV 10 014**

ORD. NO.

F BL 9502 00 99

Set of 16 galvanised hooks
without panels and support
columns

Tools excluded

ORD. NO.

F BL A010 18 04

Set of 16 galvanised hooks
with panels and support
columns ■ RAL 5012

Tools excluded



■ 01
■ 02
■ 04
■ 08

Including:

no. 1 **C MV 10 016**
no. 7 **C MV 10 037**
no. 2 **C MV 10 038**
no. 1 **C MV 10 001**
no. 1 **C MV 10 007**
no. 2 **C MV 10 021**
no. 4 **C MV 10 022**
no. 1 **C MV 10 025**

ORD. NO.

F BL 9512 00 99

Set of 19 galvanised hooks
without panels and support
columns

Tools excluded

ORD. NO.

F BL A010 21 04

Set of 19 galvanised hooks
with panels and support
columns ■ RAL 5012

Tools excluded

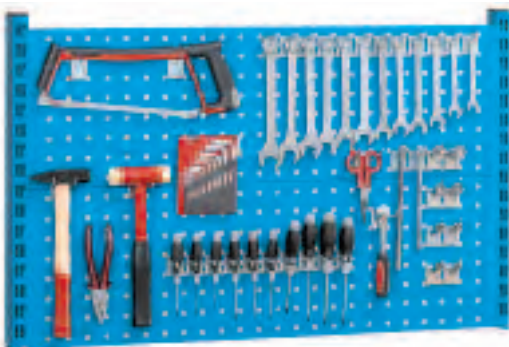

■ 01
■ 02
■ 04
■ 08

Including:

no. 1 **C MV 10 016**
no. 3 **C MV 10 007**
no. 24 **C MV 10 037**
no. 1 **C MV 10 001**
no. 8 **C MV 10 021**
no. 4 **C MV 10 022**

ORD. NO.

F BL 9511 00 99

Set of 41 galvanised hooks
without panels and support
columns

Tools excluded

ORD. NO.

F BL A010 20 04

Set of 41 galvanised hooks
with panels and support
columns ■ RAL 5012*

Tools excluded



■ 01 ■ 02 ■ 04 ■ 08

ORD. NO.

F BL 9516 00 99

Set of 19 galvanised hooks
without panels and support
columns

Tools excluded

ORD. NO.

F BL A020 27 04

Set of 19 galvanised hooks
with panels and support
columns ■ RAL 5012

Tools excluded

Including:

no. 1 **C MV 10 019** no. 4 **C MV 10 036** no. 4 **F PM1751 00 05**
no. 3 **C MV 10 001** no. 1 **C MV 10 007** no. 3 **F PM2551 00 05**
no. 3 **C MV 10 022** no. 1 **C MV 10 014** no. 2 **F BL 7448 00 99**
no. 2 **C MV 10 016** no. 1 **C MV 10 017**
no. 1 **C MV 10 003**

ORD. NO.

F BL 9522 00 99

Set of 22 galvanised hooks
without panels and support
columns

Tools excluded

ORD. NO.

F BL A020 33 04

Set of 22 galvanised hooks
with panels and support
columns ■ RAL 5012

Tools excluded

Including:

no. 3 **C MV 10 037** no. 4 **C MV 10 001** no. 1 **C MV 10 025**
no. 1 **C MV 10 036** no. 2 **C MV 10 020** no. 4 **F PM1751 00 04**
no. 2 **C MV 10 002** no. 5 **C MV 10 022** no. 1 **F BL 7438 00 99**
no. 3 **C MV 10 016**

■ 01 ■ 02 ■ 04 ■ 08

RAL 7000 F.01

RAL 6011 F.02

RAL 5012 F.04

RAL 7035 F.08

KEY ■

■ The support columns are 632 high, the panels are 1000 mm long and can be fitted to wooden worktops only.





01 02 04 08

ORD. NO.

F BL 9524 00 99

Set of 117 galvanised hooks
without panels and support
columns

Tools excluded

ORD. NO.

F BL A020 35 04

Set of 117 galvanised hooks
with panels and support
columns ■ RAL 5012

Tools excluded

Including:

- | | |
|--------------------------|--------------------------|
| no.61 C MV 10 037 | no. 2 C MV 10 016 |
| no. 1 C MV 10 025 | no.11 C MV 10 022 |
| no. 5 C MV 10 007 | no. 1 C MV 10 017 |
| no. 6 C MV 10 023 | no. 2 C MV 10 001 |
| no.12 C MV 10 021 | no.16 C MV 10 014 |

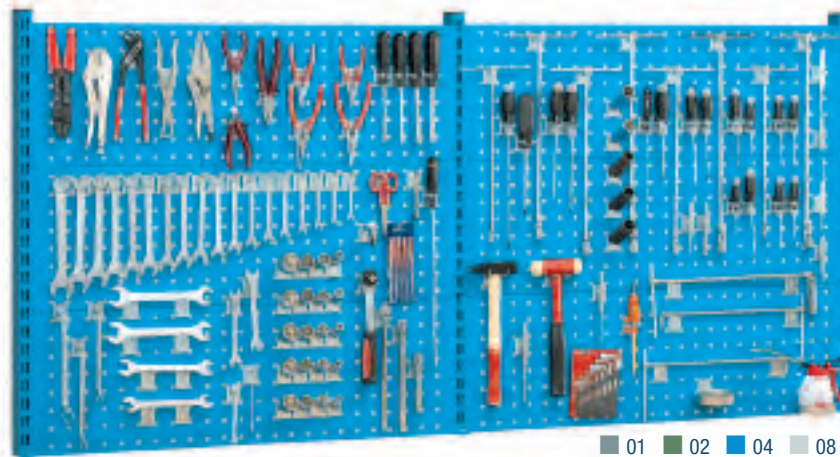

01 02 04 08

ORD. NO.

F BL 9523 00 99

Set of 84 galvanised hooks
without panels and support
columns

Tools excluded

ORD. NO.

F BL A020 34 04

Set of 84 galvanised hooks
with panels and support
columns ■ RAL 5012

Tools excluded

Including:

- | | |
|--------------------------|--------------------------|
| no.34 C MV 10 037 | no.16 C MV 10 023 |
| no. 2 C MV 10 007 | no. 6 C MV 10 014 |
| no. 2 C MV 10 006 | no. 7 C MV 10 022 |
| no. 1 C MV 10 005 | no. 5 C MV 10 021 |
| no. 4 C MV 10 016 | no. 1 C MV 10 020 |
| no. 6 C MV 10 001 | |



01
02
04
08

ORD. NO.

F BL 9526 00 99

Set of 141 galvanised hooks
without panels and support
columns

Tools excluded

ORD. NO.

F BL A030 17 04

Set of 141 galvanised hooks
with panels and support
columns ■ RAL 5012

Tools excluded

Including:

- | | | |
|--------------------------|--------------------------|--------------------------|
| no. 2 C MV 10 017 | no.58 C MV 10 037 | no.23 C MV 10 014 |
| no. 1 C MV 10 025 | no.19 C MV 10 021 | no.12 C MV 10 022 |
| no. 3 C MV 10 007 | no. 9 C MV 10 001 | no. 9 C MV 10 023 |
| no. 2 C MV 10 036 | no. 2 C MV 10 016 | no. 1 C MV 10 020 |

■ KEY

- | | | | |
|--------------------|--------------------|--------------------|--------------------|
| RAL 7000 F.01 | RAL 6011 F.02 | RAL 5012 F.04 | RAL 7035 F.08 |
|--------------------|--------------------|--------------------|--------------------|



■ The support columns are 936 high, the panels are 1000 mm long and can be fitted to wooden worktops only.



SERIES WORK-STEEL

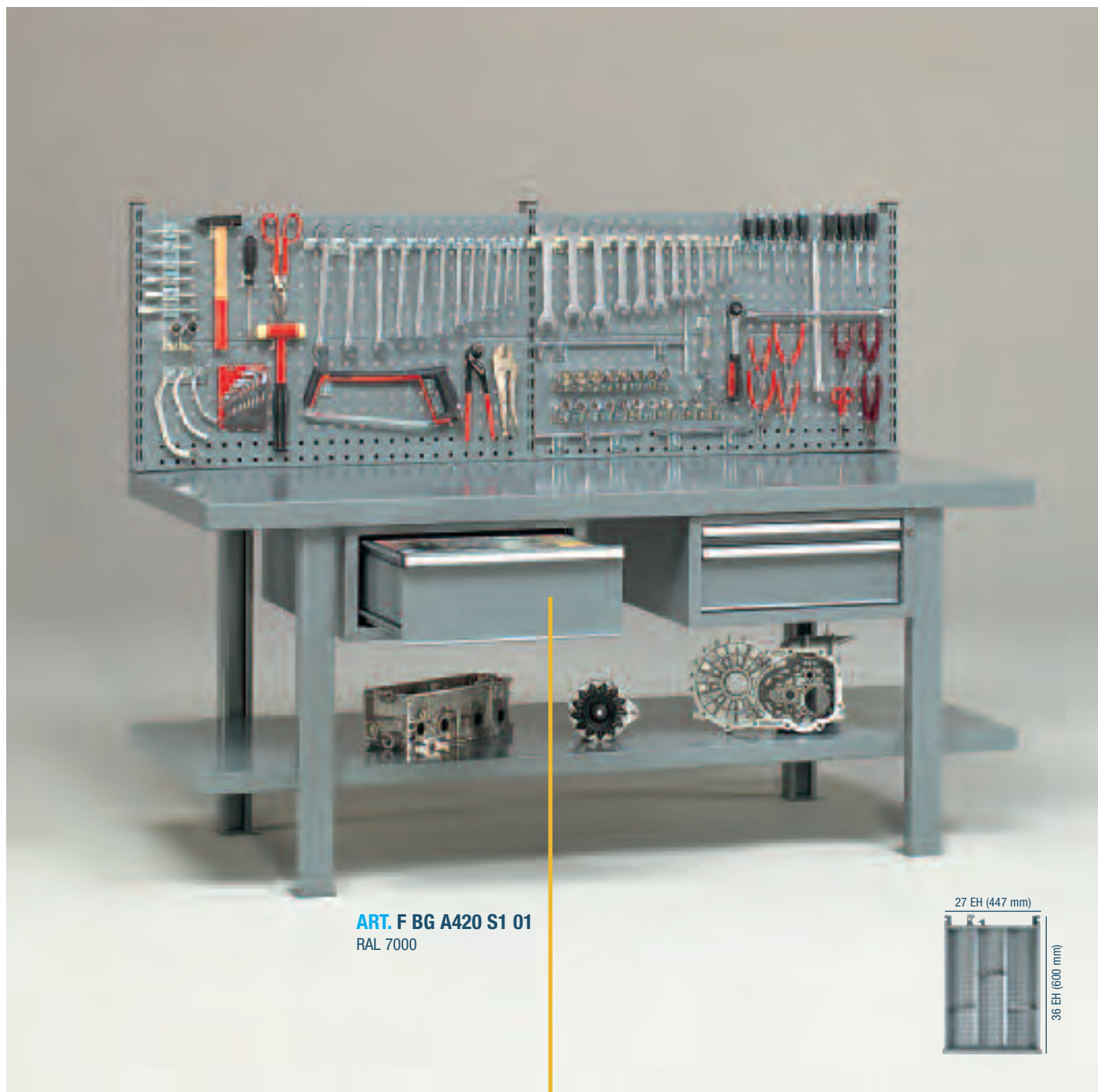

ART. F BG A420 S1 01
RAL 7000

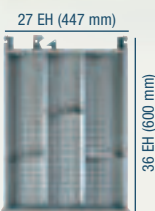
**WORKSTATION****ORD. NO.****F BG A420 S1 01**

Complete with multi-purpose back panels

Dimensions mm 2000/800x880/1515 h

Tools and set of partitioning material for drawers excluded

**SET OF PARTITIONING MATERIAL****ORD. NO.****F FH 8610 21 00**for 27x36 Eh drawer with
200 mm h front

RAL 7000 F.01

RAL 6011 F.02

RAL 5012 F.04

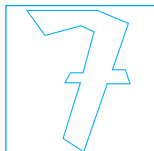

■ Set of
partitions see
page A72 -
A73

**SUPPLEMENTARY PARTS ■**

■ **Spare key.** Always indicate the number on the cylinder lock of the key to be replaced.

ORD. NO. R CSC 0002 00

■ **Master key.** This type of key opens all the 45 and 46 series locks.

ORD. NO. R CSC 0001 00



STEEL WORKSTATIONS 1200x750x880 mm h

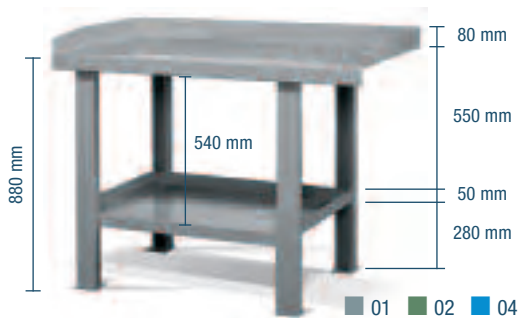

ORD. NO.	TYPE OF WORKTOP	WORKTOP LOAD CAPACITY kg	LOWER SHELF LOAD CAPACITY kg
F BG A120 00 01	Steel	2000	350
Dimensions mm 1200x750x880 h			



dimensions of lower shelf:
860x600x50 mm h

ORD. NO.	TYPE OF WORKTOP	WORKTOP LOAD CAPACITY kg	LOWER SHELF LOAD CAPACITY kg
F BG A120 01 01	Steel	2000	350
Complete with drawer unit			
Dimensions mm 1200x750x880 h			

STEEL WORKSTATIONS 1500x750x880 mm h

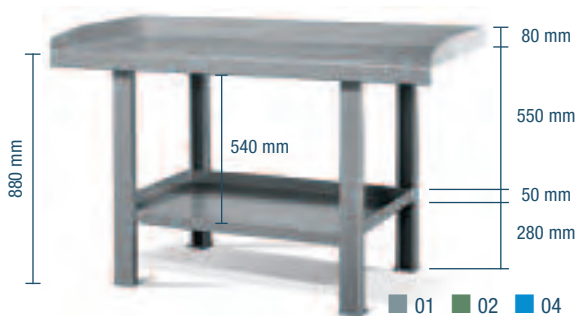

dimensions of lower shelf:
970x600x50 mm h

ORD. NO.	TYPE OF WORKTOP	WORKTOP LOAD CAPACITY kg	LOWER SHELF LOAD CAPACITY kg
F BG A220 00 01	Steel	2000	350
Dimensions mm 1500x750x880 h			



dimensions of lower shelf:
970x600x50 mm h

ORD. NO.	TYPE OF WORKTOP	WORKTOP LOAD CAPACITY kg	LOWER SHELF LOAD CAPACITY kg
F BG A220 01 01	Steel	2000	350
Complete with drawer unit			
Dimensions mm 1500x750x880 h			

KEY

RAL 7000 F.01 RAL 6011 F.02 RAL 5012 F.04



All indicated loads are net and refer to evenly distributed weights

Set of partitions see page A72 - A73

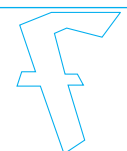

SERIES WORK

STEEL WORKSTATIONS 1500x800x880/1515 mm h



ORD. NO.	TYPE OF WORKTOP	WORKTOP LOAD CAPACITY kg	LOWER SHELF LOAD CAPACITY kg
F BG A320 00 01	Steel	2000	350

Dimensions mm 1500x800x880/1515 h



ORD. NO.	TYPE OF WORKTOP	WORKTOP LOAD CAPACITY kg	LOWER SHELF LOAD CAPACITY kg
F BG A320 01 01	Steel	2000	350

Complete with drawer unit
Dimensions mm 1500x800x880/1515 h

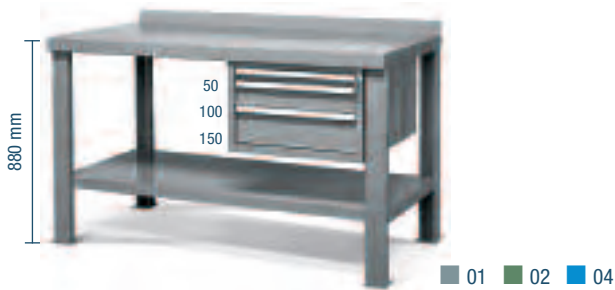

ORD. NO.	TYPE OF WORKTOP	WORKTOP LOAD CAPACITY kg	LOWER SHELF LOAD CAPACITY kg
F BG A320 03 01	Steel	2000	350

Complete with drawer unit
Dimensions mm 1500x800x880/1515 h

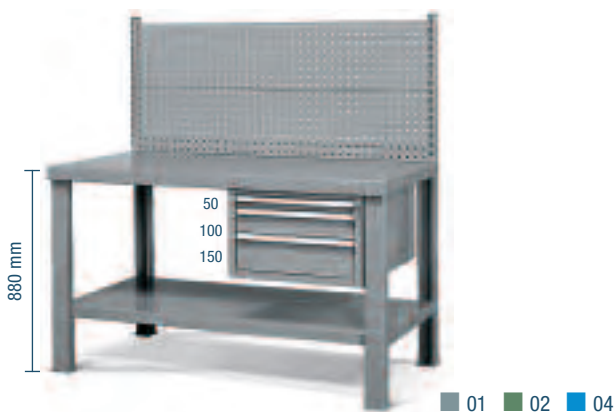

ORD. NO.	TYPE OF WORKTOP	WORKTOP LOAD CAPACITY kg	LOWER SHELF LOAD CAPACITY kg
F BG A320 53 01	Steel	2000	350

Complete with drawer unit and 2 perforated back panels total height 608 mm
Dimensions mm 1500x800x880/1515 h

RAL 7000 F.01 RAL 6011 F.02 RAL 5012 F.04



■ Set of partitions see page A72 - A73

KEY ■

■ All indicated loads are net and refer to evenly distributed weights



STEEL WORKSTATIONS 2000x800x880/1515 mm h

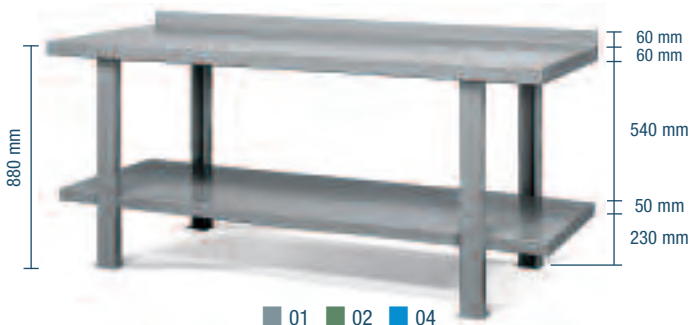

ORD. NO.	TYPE OF WORKTOP	WORKTOP LOAD CAPACITY kg	LOWER SHELF LOAD CAPACITY kg
F BG A420 00 01	Steel	2000	350

Dimensions mm 2000x800x880/1515 h

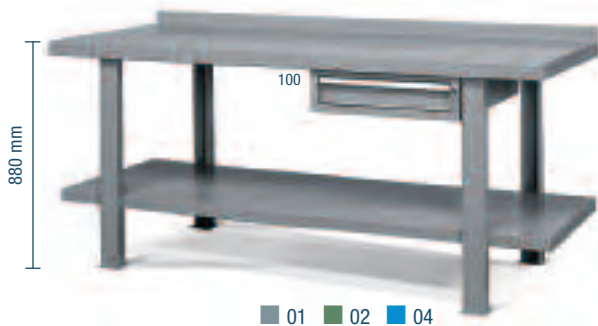

ORD. NO.	TYPE OF WORKTOP	WORKTOP LOAD CAPACITY kg	LOWER SHELF LOAD CAPACITY kg
F BG A420 01 01	Steel	2000	350

Complete with drawer unit
Dimensions mm 2000x800x880/1515 h

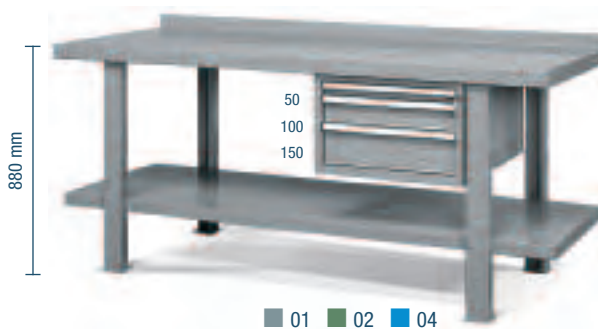

ORD. NO.	TYPE OF WORKTOP	WORKTOP LOAD CAPACITY kg	LOWER SHELF LOAD CAPACITY kg
F BG A420 03 01	Steel	2000	350

Complete with drawer unit
Dimensions mm 2000x800x880/1515 h

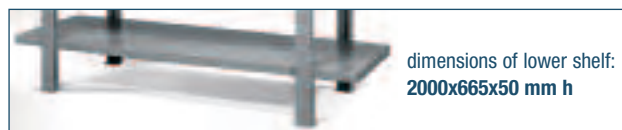
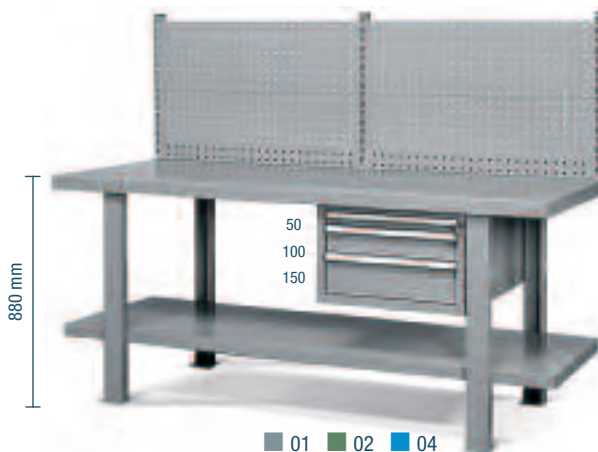

ORD. NO.	TYPE OF WORKTOP	WORKTOP LOAD CAPACITY kg	LOWER SHELF LOAD CAPACITY kg
F BG A420 53 01	Steel	2000	350

Complete with drawer unit and 4 perforated back panels total height 608 mm
Dimensions mm 2000x800x880/1515 h

KEY

- RAL 7000 F.01
- RAL 6011 F.02
- RAL 5012 F.04



All indicated loads are net and refer to evenly distributed weights

Set of partitions see page A72 - A73

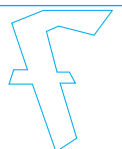

SERIES WORK-SEAT

BEECH-PLYWOOD CHAIRS



■ 07

ORD. NO.**F QZ 1111 00 07**

Swivel chair with double swivel wheels, seat and back in beech-plywood.
Seat height adjustable by screw.
Height: from mm 530 to mm 645.



■ 07

ORD. NO.**F QZ 1110 00 07**

Swivel chair with low noise floor feet, seat and back in beech-plywood.
Seat height adjustable by screw.
Height: from mm 501 to mm 620.



■ 07

ORD. NO.**F QZ 1120 00 07**

Swivel chair with low noise floor feet and additional chromium-plated foot rest, height adjustable.
Seat and back in beech-plywood.
Seat height adjustable by screw.
Height: from mm 501 to mm 710.



■ 07

ORD. NO.**F QZ 1130 00 07**

Swivel chair with stationary base and painted foot rest.
Seat and back in beech-plywood.
Seat height adjustable by screw.
Height: from mm 510 to mm 710.



■ 07

ORD. NO.**F QZ 1211 00 07**

Swivel chair with double swivel wheels, seat and back in beech-plywood.
Seat height adjustable by gas pump.
Height: from mm 470 to mm 645.



■ 07

ORD. NO.**F QZ 1210 00 07**

Swivel chair with low noise floor feet, seat and back in beech-plywood.
Seat height adjustable by gas pump.
Height: from mm 445 to mm 625.



■ 07

ORD. NO.**F QZ 1220 00 07**

Swivel chair with low noise floor feet and additional chromium-plated foot rest, height adjustable.
Seat and back in beech-plywood.
Seat height adjustable by gas pump.
Height: from mm 510 to mm 760.



■ 07

ORD. NO.**F QZ 1310 00 07**

Swivel chair with low noise floor feet, seat and back in beech-plywood.
Seat height adjustable by molomatic screw.
Height: from mm 425 to mm 565.

POLYURETHANE CHAIRS



■ 07

ORD. NO.**F QZ 2211 00 07**

Swivel chair with double swivel wheels, seat and back in polyurethane.
Seat height adjustable by gas pump.
Height: from mm 495 to mm 670.



■ 07

ORD. NO.**F QZ 2210 00 07**

Swivel chair with low noise floor feet, seat and back in polyurethane.
Seat height adjustable by gas pump.
Height: from mm 470 to mm 650.



■ 07

ORD. NO.**F QZ 2220 00 07**

Swivel chair with low noise floor feet and foot rest.
Seat and back in polyurethane.
Seat height adjustable by gas pump.
Height: from mm 535 to mm 785.



■ 07

ORD. NO.**F QZ 2110 00 07**

Swivel chair with low noise floor feet and painted foot rest.
Seat and back in polyurethane.
Seat height adjustable by screw.
Height: from mm 535 to mm 735.

STEEL VICES



front opening



front opening



front opening



rear opening

STEEL VICE JAW WIDTH 80 mm

ORD. NO.	SUITABLE FOR
FBL 1010 00 00	Wooden worktop
FBL 1010 01 00	Steel worktop
A = 100 mm	D = 83 mm
B = 330 mm	E = knurled
C = 80 mm	G = 4 kg

STEEL VICE JAW WIDTH 110 mm

ORD. NO.	SUITABLE FOR
FBL 1015 00 00	Wooden worktop
FBL 1015 01 00	Steel worktop
A = 120 mm	D = 113 mm
B = 385 mm	E = knurled
C = 110 mm	G = 7 kg

STEEL VICE JAW WIDTH 130 mm

ORD. NO.	SUITABLE FOR
FBL 1020 00 00	Wooden worktop
FBL 1020 01 00	Steel worktop
A = 140 mm	D = 137 mm
B = 430 mm	E = knurled
C = 130 mm	G = 11 kg

STEEL VICE JAW WIDTH 120 mm

ORD. NO.	SUITABLE FOR
FBL 1065 00 00	Wooden worktop
FBL 1065 01 00	Steel worktop
A = 175 mm	D = 187 mm
B = 510 mm	E = knurled
C = 120 mm	G = 24 kg

CAST IRON VICES



rear opening



rear opening



rear opening

*CAST IRON VICE JAW WIDTH 100 mm

ORD. NO.	SUITABLE FOR
FBL 1110 00 00	Wooden worktop
FBL 1110 01 00	Steel worktop
A = 140 mm	D = 153 mm
B = 445 mm	E = knurled
C = 100 mm	G = 11 kg

*CAST IRON VICE JAW WIDTH 120 mm

ORD. NO.	SUITABLE FOR
FBL 1120 00 00	Wooden worktop
FBL 1120 01 00	Steel worktop
A = 185 mm	D = 180 mm
B = 520 mm	E = knurled
C = 120 mm	G = 18 kg

**CAST IRON VICE JAW WIDTH 150 mm

ORD. NO.	SUITABLE FOR
FBL 1130 00 00	Wooden worktop
FBL 1130 01 00	Steel worktop
A = 220 mm	D = 210 mm
B = 615 mm	E = knurled
C = 150 mm	G = 25 kg

* Cast iron vices can not be assembled on 30 mm thickness worktops.

** For wooden worktops 50 mm h only.

A = maximum jaw opening B = maximum width of vice C = width of jaws D = height of vice E = knurled jaws G = weight of vice

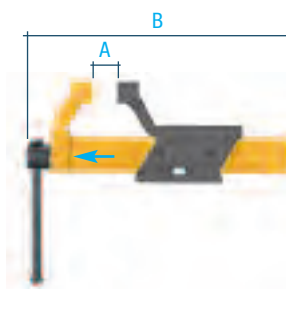
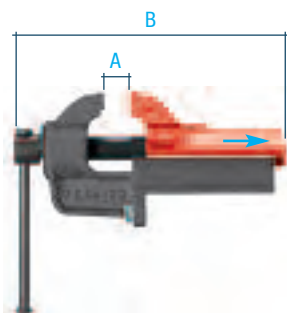

■ INFO



www.famispa.com

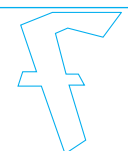

ORGANIZE SPACE

LET'S REORG

- SMART TROLLEYS SERIES UNIMOD
- SLICK SHELVING SYSTEM SERIES UNIMOD
- COMFORT WORKSTATIONS SERIES UNIMOD
- DYNAMIC WORKSTATIONS SERIES UNIMOD



ORGANIZE SPACE LET'S REORG



TROLLEYS SERIES SMART



ORD. NO. F LB B102 56 52
GALVANISED + RAL 7000

ORD. NO. F LB B073 54 52
GALVANISED + RAL 7000

ORD. NO. F LB B103 52 52
GALVANISED + RAL 7000

TROLLEY WITH CONTAINERS

ORD. NO. DIMENSIONS mm

F LB B102 56 52 1023x613x1430 h

Complete with:

1 trolley ORD. NO. F LB B102 06 52

45 containers size 1

24 containers size 2

28 containers size 3A2

Load capacity: 300 kg (150 kg per side)

Standard colour:

**TROLLEY WITH PRACTIBOX**

ORD. NO. DIMENSIONS mm

F LB B073 54 52 725x613x1430 h

Complete with:

1 trolley ORD. NO. F LB B073 04 52

4 drawer cabinets with 9 practibox drawers

6 drawer cabinets with 6 practibox drawers

4 drawer cabinets with 5 practibox drawers

2 drawer cabinets with 4 practibox drawers

2 drawer cabinets with 3 practibox drawers

Load capacity: 300 kg (150 kg per side)

Standard colour:

**TROLLEY WITH CONTAINERS**

ORD. NO. DIMENSIONS mm

F LB B103 52 52 1023x613x1430 h

Complete with:

1 trolley ORD. NO. F LB B103 02 52

4 containers ORD. NO. F PA 6451 A0 01

2 containers ORD. NO. F PA 6851 A0 01

1 container ORD. NO. F PA 8951 A0 01

Load capacity: 300 kg (150 kg per side)

Standard colour:

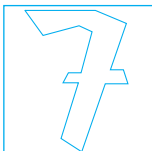

GALVANISED + RAL 7000 F... ..52

**KEY ■**

- Trolleys are supplied fitted with wheels and frame to be assembled
- Possibility of using uprights – height 1772 mm (see page D20)
- Accessories and material stored on the trolleys must not overhang the base of the trolley
- All indicated loads are net and refer to evenly distributed weights



LENGTH = 1023 mm DEPTH = 613 mm

TROLLEYS SERIES SMART 101

TROLLEYS SMART 101

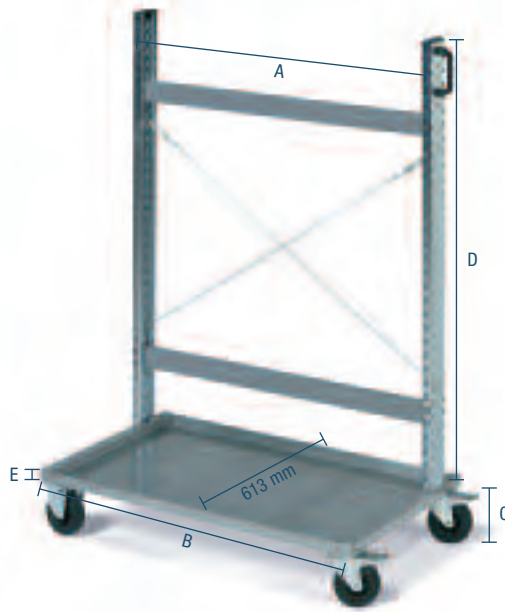

EMPTY TROLLEY

ORD. NO.	DIMENSIONS mm
F LB B101 01 52	1023x613x1430 h
2 swivel wheels with brake Ø 125 mm	
2 fixed standard rubber wheels Ø 125 mm	
Load capacity: 300 kg (150 kg per side)	
Standard colour:	
■ ■ 52	

EMPTY TROLLEY WITHOUT WHEELS

ORD. NO.	DIMENSIONS mm
F LB 0101 01 52	1023x613x1270 h

A= 985 mm
 B= 1023 mm
 C= 160 mm
 D= 1240 mm (32 holes)
 E= 30 mm



TROLLEY WITHOUT CONTAINERS

ORD. NO.	DIMENSIONS mm
F LB B101 02 52	1023x613x1430 h
Complete with:	
3 shelves for size 2	
2 shelves for size 3A2	
1 shelf depth 420 mm (A=985 mm)	
2 swivel wheels with brake Ø 125 mm	
2 fixed standard rubber wheels Ø 125 mm	
Load capacity: 300 kg (150 kg per side)	
Standard colour:	
■ ■ 52	

TROLLEY WITH CONTAINERS

ORD. NO.	DIMENSIONS mm
F LB B101 52 52	1023x613x1430 h
Complete with:	
1 trolley ORD. NO. F LB B101 02 52	
18 containers size 2	
8 containers size 3A2	
3 containers size 4A2	
3 containers size 4	

- Fixed shelves load capacity 25 kg each
- Tilting shelves load capacity 50 kg each

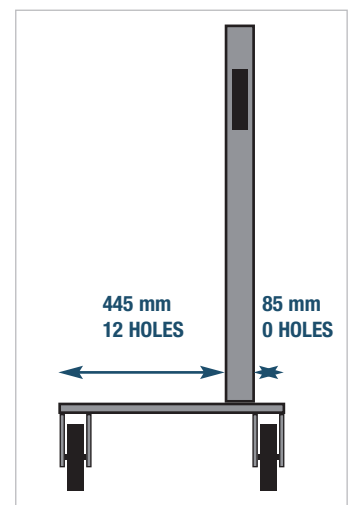

■ KEY



- Trolleys are supplied fitted with wheels and frame to be assembled
- Possibility of using uprights – height 1772 mm (see page D20)
- Accessories and material stored on the trolleys must not overhang the base of the trolley
- All indicated loads are net and refer to evenly distributed weights

■ Containers see page G28 - G30

GALVANISED + RAL 7000 F.52

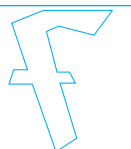

LENGTH = 1023 mm DEPTH = 613 mm

TROLLEYS SERIES SMART 102

TROLLEYS SMART 102

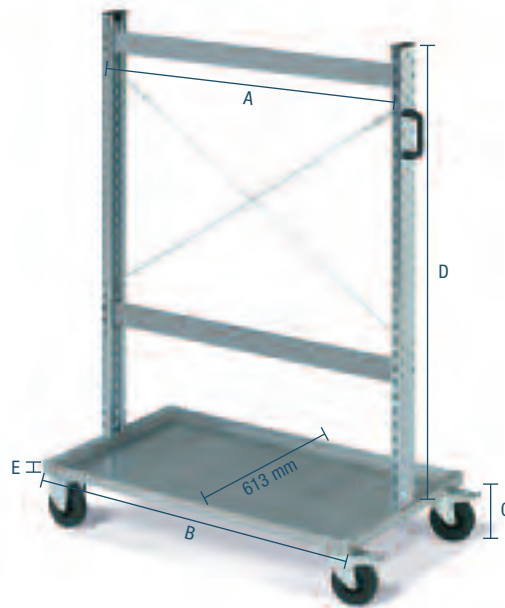

EMPTY TROLLEY

ORD. NO.	DIMENSIONS mm
F LB B102 01 52	1023x613x1430 h
2 swivel wheels with brake Ø 125 mm	
2 fixed standard rubber wheels Ø 125 mm	
Load capacity: 300 kg (150 kg per side)	
Standard colour:	
■ ■ 52	

EMPTY TROLLEY WITHOUT WHEELS

ORD. NO.	DIMENSIONS mm
F LB 0102 01 52	1023x613x1270 h

A= 985 mm
 B= 1023 mm
 C= 160 mm
 D= 1240 mm (32 holes)
 E= 30 mm

TROLLEYS SMART 102



Front

TROLLEY WITHOUT CONTAINERS

ORD. NO.	DIMENSIONS mm
F LB B102 02 52	1023x613x1430 h
Complete with:	
20 shelves for size 1	
2 swivel wheels with brake Ø 125 mm	
2 fixed standard rubber wheels Ø 125 mm	
Load capacity: 300 kg (150 kg per side)	
Standard colour:	
■ ■ 52	



Rear

TROLLEY WITH CONTAINERS

ORD. NO.	DIMENSIONS mm
F LB B102 52 52	1023x613x1430 h
Complete with:	
1 trolley ORD. NO. F LB B102 02 52	
180 containers size 1	

■ Fixed shelves load capacity 25 kg each

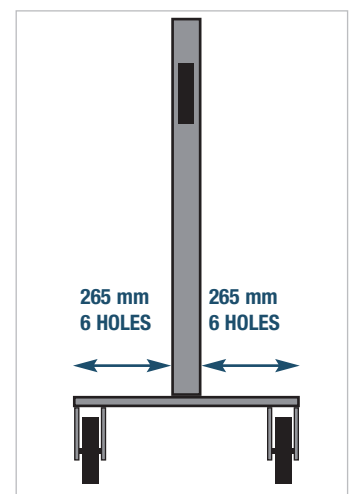

GALVANISED + RAL 7000 F.52

KEY ■

■ Containers see page G28 - G30

- Trolleys are supplied fitted with wheels and frame to be assembled
- Possibility of using uprights – height 1772 mm (see page D20)
- Accessories and material stored on the trolleys must not overhang the base of the trolley
- All indicated loads are net and refer to evenly distributed weights



LENGTH = 1023 mm DEPTH = 613 mm

TROLLEYS SERIES SMART 102

TROLLEYS SMART 102



Front

■ Fixed shelves load capacity 25 kg each

TROLLEY WITHOUT CONTAINERS

ORD. NO.	DIMENSIONS mm
F LB B102 03 52	1023x613x1430 h
Complete with:	
10 shelves for size 1	
8 shelves for size 2	
2 swivel wheels with brake Ø 125 mm	
2 fixed standard rubber wheels Ø 125 mm	
Load capacity: 300 kg (150 kg per side)	
Standard colour:	
■ ■ 52	



Rear

TROLLEY WITH CONTAINERS

ORD. NO.	DIMENSIONS mm
F LB B102 53 52	1023x613x1430 h
Complete with:	
1 trolley ORD. NO. F LB B102 03 52	
90 containers size 1	
24 containers size 2	

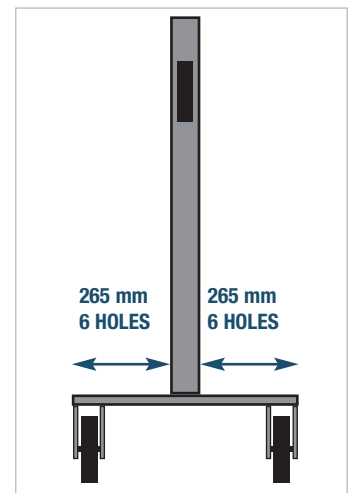

TROLLEYS SMART 102



Front

■ Fixed shelves load capacity 25 kg each

TROLLEY WITHOUT CONTAINERS

ORD. NO.	DIMENSIONS mm
F LB B102 04 52	1023x613x1430 h
Complete with:	
14 shelves for size 2	
2 swivel wheels with brake Ø	
2 fixed standard rubber wheels Ø 125 mm	
Load capacity: 300 kg (150 kg per side)	
Standard colour:	
■ ■ 52	



Rear

TROLLEY WITH CONTAINERS

ORD. NO.	DIMENSIONS mm
F LB B102 54 52	1023x613x1430 h
Complete with:	
1 trolley ORD. NO. F LB B102 04 52	
84 containers size 2	

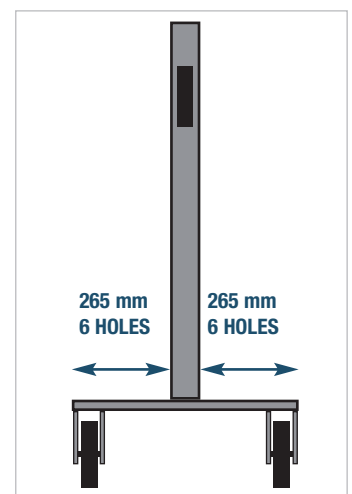

■ KEY



- Trolleys are supplied fitted with wheels and frame to be assembled
- Possibility of using uprights – height 1772 mm (see page D20)
- Accessories and material stored on the trolleys must not overhang the base of the trolley
- All indicated loads are net and refer to evenly distributed weights

■ Containers see page **G28 - G30**

GALVANISED + RAL 7000 F. 52

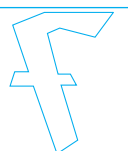

TROLLEYS SERIES SMART 102

TROLLEYS SMART 102



Front

- Fixed shelves load capacity 25 kg each
- Roller shutter cabinet load capacity 50 kg each

TROLLEY WITHOUT CONTAINERS

ORD. NO.	DIMENSIONS mm
F LB B102 05 52	1023x613x1430 h
Complete with:	
4 shelves for size 2	
2 roller shutter cabinets without hooks or tools	
2 swivel wheels with brake Ø 125 mm	
2 fixed standard rubber wheels Ø 125 mm	
Load capacity: 300 kg (150 kg per side)	

Standard colour:

■ ■ 52



Rear

TROLLEY WITH CONTAINERS

ORD. NO.	DIMENSIONS mm
F LB B102 55 52	1023x613x1430 h
Complete with:	
1 trolley ORD. NO. F LB B102 05 52	
24 containers size 2	
2 sets of 54 hooks (each)	
ORD. NO. F BL 9510 00 99	

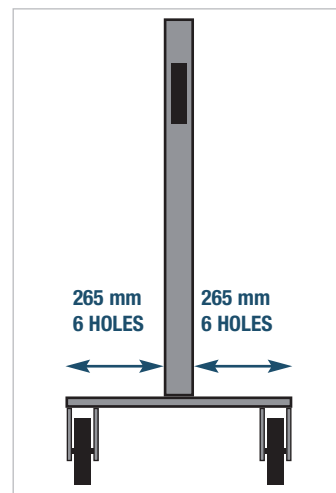

TROLLEYS SMART 102



Front

- Fixed shelves load capacity 25 kg each

TROLLEY WITHOUT CONTAINERS

ORD. NO.	DIMENSIONS mm
F LB B102 06 52	1023x613x1430 h
Complete with:	
5 shelves for size 1	
4 shelves for size 2	
6 shelves for size 3A2	
2 swivel wheels with brake Ø 125 mm	
2 fixed standard rubber wheels Ø 125 mm	
Load capacity: 300 kg (150 kg per side)	

Standard colour:

■ ■ 52



Rear

TROLLEY WITH CONTAINERS

ORD. NO.	DIMENSIONS mm
F LB B102 56 52	1023x613x1430 h
Complete with:	
1 trolley ORD. NO. F LB B102 06 52	
45 containers size 1	
24 containers size 2	
28 containers size 3A2	

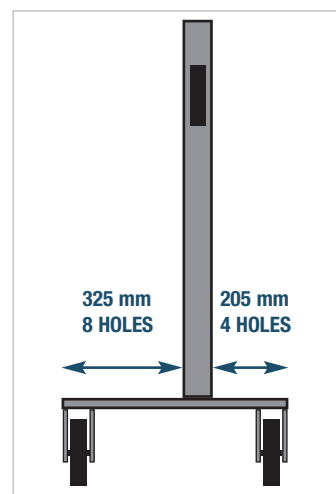

GALVANISED + RAL 7000 F.52

KEY ■

■ Containers
see page
G28 - G30

- Trolleys are supplied fitted with wheels and frame to be assembled
- Possibility of using uprights – height 1772 mm (see page D20)
- Accessories and material stored on the trolleys must not overhang the base of the trolley
- All indicated loads are net and refer to evenly distributed weights



LENGTH = 1023 mm DEPTH = 613 mm

TROLLEYS SERIES SMART 102

TROLLEYS SMART 102



Front

- Fixed shelves load capacity 25 kg each
- Roller shutter cabinet load capacity 50 kg each

TROLLEY WITHOUT CONTAINERS

ORD. NO.	DIMENSIONS mm
F LB B102 07 52	1023x613x1430 h
Complete with:	
3 shelves for size 1	
4 shelves for size 2	
3 shelves for size 3A2	
1 roller shutter cabinet without hooks or tools	
2 swivel wheels with brake Ø 125 mm	
2 fixed standard rubber wheels Ø 125 mm	
Load capacity: 300 kg (150 kg per side)	

Standard colour:
■ ■ 52



Rear

TROLLEY WITH CONTAINERS

ORD. NO.	DIMENSIONS mm
F LB B102 57 52	1023x613x1430 h
Complete with:	
1 trolley ORD. NO. F LB B102 07 52	
27 containers size 1	
24 containers size 2	
12 containers size 3A2	
1 set of 54 hooks ORD. NO. F BL 9510 00 99	

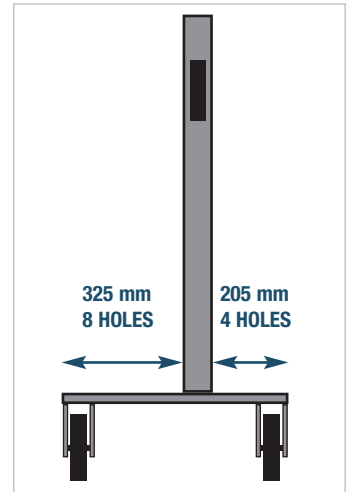

TROLLEYS SMART 102



Front

- Fixed shelves load capacity 25 kg each
- Tilting shelves load capacity 50 kg each

TROLLEY WITHOUT CONTAINERS

ORD. NO.	DIMENSIONS mm
F LB B102 08 52	1023x613x1430 h
Complete with:	
5 shelves for size 1	
4 shelves for size 2	
5 shelves depth 320 mm (A=985 mm)	
2 swivel wheels with brake Ø 125 mm	
2 fixed standard rubber wheels Ø 125 mm	
Load capacity: 300 kg (150 kg per side)	

Standard colour:
■ ■ 52



Rear

TROLLEY WITH CONTAINERS

ORD. NO.	DIMENSIONS mm
F LB B102 58 52	1023x613x1430 h
Complete with:	
1 trolley ORD. NO. F LB B102 08 52	
45 containers size 1	
24 containers size 2	
6 containers ORD. NO. F PA 4051 A0 01	
4 containers ORD. NO. F PA 4451 A0 01	

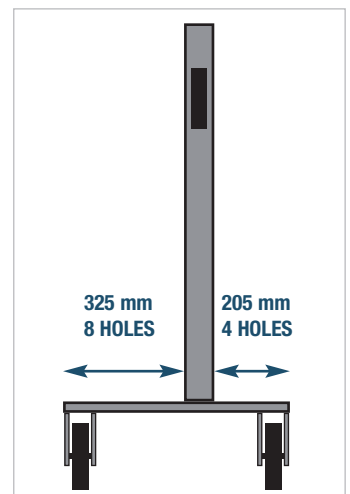

■ KEY



- Trolleys are supplied fitted with wheels and frame to be assembled
- Possibility of using uprights – height 1772 mm (see page D20)
- Accessories and material stored on the trolleys must not overhang the base of the trolley
- All indicated loads are net and refer to evenly distributed weights

■ Containers see page G2

■ Containers see page G28 - G30

GALVANISED + RAL 7000 F... ..52

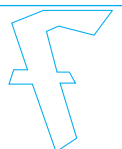

TROLLEYS SERIES SMART 102

LENGTH = 1023 mm DEPTH = 613 mm

TROLLEYS SMART 102



Front

- Tilting shelves load capacity 50 kg each
- Perforated panel load capacity 25 kg each

TROLLEY WITHOUT CONTAINERS

ORD. NO. DIMENSIONS mm

F LB B102 09 52 1023x613x1430 h

Complete with:

6 shelves depth 220 mm (A=985 mm)

4 perforated panels (A=985 mm) without hooks or tools

2 swivel wheels with brake Ø 125 mm

2 fixed standard rubber wheels Ø 125 mm

Load capacity: 300 kg (150 kg per side)

Standard colour:

■ ■ 52



Rear

TROLLEY WITH CONTAINERS

ORD. NO. DIMENSIONS mm

F LB B102 59 52 1023x613x1430 h

Complete with:

1 trolley ORD. NO. F LB B102 09 52

12 containers ORD. NO. F PA 2451 A0 01

12 containers ORD. NO. F PA 2851 A0 01

2 sets of 54 hooks (each)

ORD. NO. F BL 9510 00 99

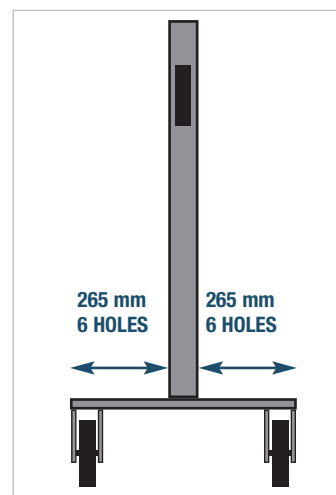

TROLLEYS SMART 102



Front

- Tilting shelves load capacity 50 kg each
- Perforated panel load capacity 25 kg each

TROLLEY WITHOUT CONTAINERS

ORD. NO. DIMENSIONS mm

F LB B102 10 52 1023x613x1430 h

Complete with:

8 shelves depth 220 mm (A=985 mm)

2 perforated panels (A=985 mm) without hooks or tools

2 swivel wheels with brake Ø 125 mm

2 fixed standard rubber wheels Ø 125 mm

Load capacity: 300 kg (150 kg per side)

Standard colour:

■ ■ 52



Rear

TROLLEY WITH CONTAINERS

ORD. NO. DIMENSIONS mm

F LB B102 60 52 1023x613x1430 h

Complete with:

1 trolley ORD. NO. F LB B102 10 52

18 containers ORD. NO. F PA 2451 A0 01

6 containers ORD. NO. F PA 2851 A0 01

1 set of 54 hooks ORD. NO. F BL 9510 00 99

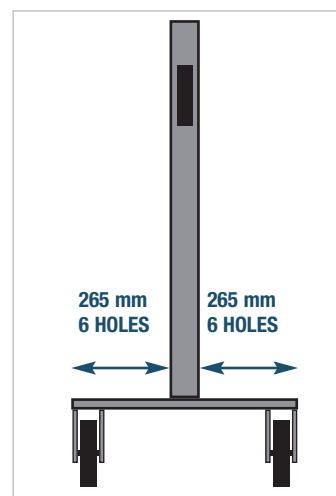

GALVANISED + RAL 7000 F.52

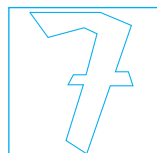

- Containers see page G2

KEY ■

- Trolleys are supplied fitted with wheels and frame to be assembled
- Possibility of using uprights – height 1772 mm (see page D20)
- Accessories and material stored on the trolleys must not overhang the base of the trolley
- All indicated loads are net and refer to evenly distributed weights



LENGTH = 1023 mm DEPTH = 613 mm

TROLLEYS SERIES SMART 102

TROLLEYS SMART 102



- Fixed shelves load capacity 25 kg each
- Tilting shelves load capacity 50 kg each
- Drawer load capacity 70 kg each

TROLLEY WITHOUT CONTAINERS

ORD. NO.	DIMENSIONS mm
F LB B102 11 52	1023x613x1430 h
Complete with:	
4 shelves for size 1	
3 shelves for size 2	
4 shelves depth 320 mm (A=985 mm)	
2 cabinets with drawers FLEXA 19x27 Eh	
2 swivel wheels with brake Ø 125 mm	
2 fixed standard rubber wheels Ø 125 mm	
Load capacity: 300 kg (150 kg per side)	
Standard colour:	
■ ■ 52	



TROLLEY WITH CONTAINERS

ORD. NO.	DIMENSIONS mm
F LB B102 61 52	1023x613x1430 h
Complete with:	
1 trolley ORD. NO. F LB B102 11 52	
36 containers size 1	
18 containers size 2	
6 containers ORD. NO. F PA 4051 A0 01	
2 containers ORD. NO. F PA 4451 A0 01	

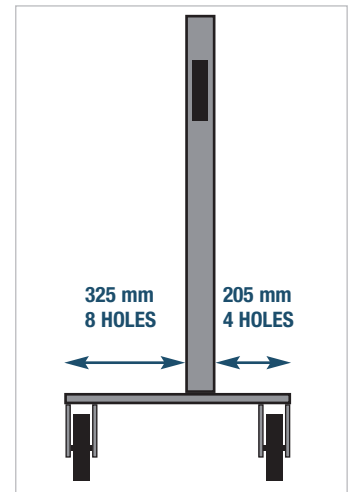

TROLLEYS SMART 102



- Tilting shelves load capacity 50 kg each

TROLLEY WITHOUT CONTAINERS

ORD. NO.	DIMENSIONS mm
F LB B102 12 52	1023x613x1430 h
Complete with:	
3 shelves depth 420 mm (A=985 mm)	
2 swivel wheels with brake Ø 125 mm	
2 fixed standard rubber wheels Ø 125 mm	
Load capacity: 300 kg (150 kg per side)	
Standard colour:	
■ ■ 52	

TROLLEY WITH CONTAINERS

ORD. NO.	DIMENSIONS mm
F LB B102 62 52	1023x613x1430 h
Complete with:	
1 trolley ORD. NO. F LB B102 12 52	
9 containers ORD. NO. F PA 4451 A0 01	
2 containers ORD. NO. F PA 6451 A0 01	

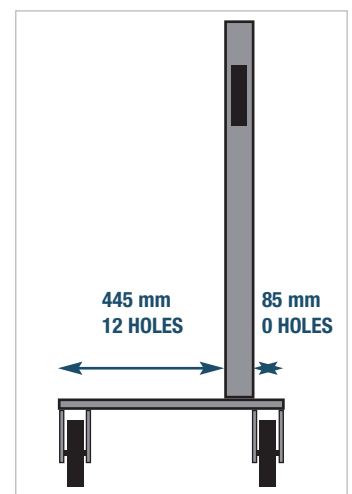

■ KEY



- Trolleys are supplied fitted with wheels and frame to be assembled
- Possibility of using uprights – height 1772 mm (see page D20)
- Accessories and material stored on the trolleys must not overhang the base of the trolley
- All indicated loads are net and refer to evenly distributed weights

■ Containers see page **G2**

■ Containers see page **G28 - G30**

GALVANISED + RAL 7000 F... ..52



TROLLEYS SERIES SMART 103

TROLLEYS SMART 103

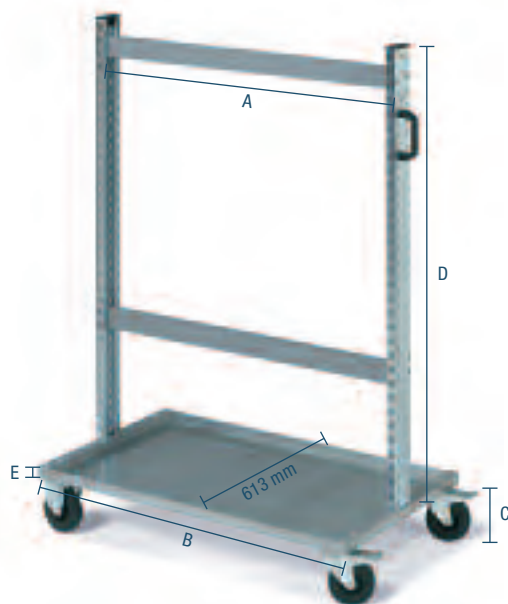

EMPTY TROLLEY

ORD. NO.	DIMENSIONS mm
F LB B103 01 52	1023x613x1430 h
2 swivel wheels with brake Ø 125 mm	
2 fixed standard rubber wheels Ø 125 mm	
Load capacity: 300 kg (150 kg per side)	
Standard colour:	
■ ■ 52	

EMPTY TROLLEY WITHOUT WHEELS

ORD. NO.	DIMENSIONS mm
F LB 0103 01 52	1023x613x1270 h

A= 985 mm
 B= 1023 mm
 C= 160 mm
 D= 1240 mm (32 holes)
 E= 30 mm

TROLLEYS SMART 103



TROLLEY WITHOUT CONTAINERS

ORD. NO.	DIMENSIONS mm
F LB B103 02 52	1023x613x1430 h
Complete with:	
3 shelves depth 600 mm (A=985 mm)	
2 swivel wheels with brake Ø 125 mm	
2 fixed standard rubber wheels Ø 125 mm	
Load capacity: 300 kg (150 kg per side)	
Standard colour:	
■ ■ 52	

TROLLEY WITH CONTAINERS

ORD. NO.	DIMENSIONS mm
F LB B103 52 52	1023x613x1430 h
Complete with:	
1 trolley ORD. NO. F LB B103 02 52	
4 containers ORD. NO. F PA 6451 A0 01	
2 containers ORD. NO. F PA 6851 A0 01	
1 container ORD. NO. F PA 8951 A0 01	

■ Tilting shelves load capacity 50 kg each

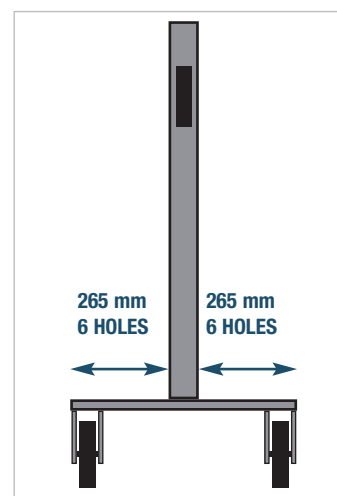

GALVANISED + RAL 7000 F.52

KEY ■

■ Containers see page G2

- Trolleys are supplied fitted with wheels and frame to be assembled
- Possibility of using uprights – height 1772 mm (see page D20)
- Accessories and material stored on the trolleys must not overhang the base of the trolley
- All indicated loads are net and refer to evenly distributed weights



LENGTH = 1023 mm DEPTH = 613 mm

TROLLEYS SERIES SMART 103

TROLLEYS SMART 103



Front

■ Tilting shelves load capacity 50 kg each

TROLLEY WITHOUT CONTAINERS

ORD. NO.	DIMENSIONS mm
F LB B103 03 52	1023x613x1430 h
Complete with:	
3 shelves depth 420 mm (A=985 mm)	
2 swivel wheels with brake Ø 125 mm	
2 fixed standard rubber wheels Ø 125 mm	
Load capacity: 300 kg (150 kg per side)	
Standard colour:	
■ 52	

TROLLEY WITH CONTAINERS

ORD. NO.	DIMENSIONS mm
F LB B103 53 52	1023x613x1430 h
Complete with:	
1 trolley ORD. NO. F LB B103 03 52	
5 containers ORD. NO. F PA 4451 A0 01	
2 containers ORD. NO. F PA 6451 A0 01	
2 containers ORD. NO. F PA 6851 A0 01	

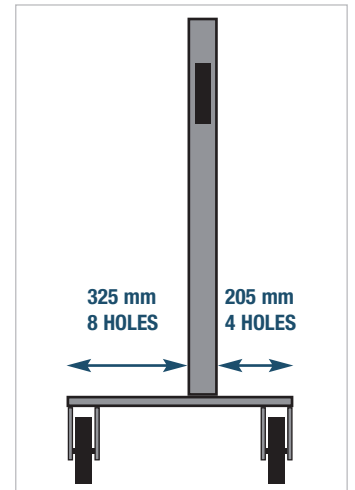

2 STIFFENING BAR

ORD. NO.	LENGTH mm
F BL 4505 00 01	1011 (A=985)
Standard colour: ■ 01	

The bar (ref. 2) can be mounted under the shelf (depth 420 / 600 mm) to increase the load capacity of the shelf from 50 to 100 kg.

■ The B103 series trolleys are supplied with 2 stiffening bars



Example of use of the LB Unimod series trolleys

■ KEY



- Trolleys are supplied fitted with wheels and frame to be assembled
- Possibility of using uprights – height 1772 mm (see page D20)
- Accessories and material stored on the trolleys must not overhang the base of the trolley
- All indicated loads are net and refer to evenly distributed weights

■ Containers see page G2

RAL 7000 F. 01 GALVANISED + RAL 7000 F. 52

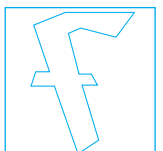

TROLLEYS SERIES SMART 073

TROLLEYS SMART 073

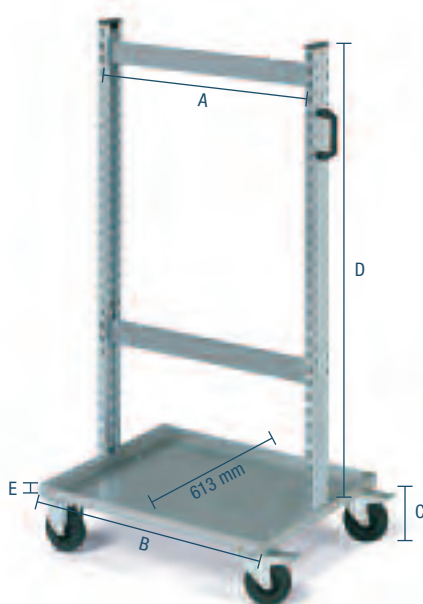

EMPTY TROLLEY

ORD. NO.	DIMENSIONS mm
F LB B073 01 52	725x613x1430 h
2 swivel wheels with brake	
2 fixed standard rubber wheels Ø 125 mm	
Load capacity: 300 kg (150 kg per side)	
Standard colour:	
■ ■ 52	

EMPTY TROLLEY WITHOUT WHEELS

ORD. NO.	DIMENSIONS mm
F LB 0073 01 52	725x613x1270 h

A= 687 mm
 B= 724 mm
 C= 160 mm
 D= 1240 mm (32 holes)
 E= 30 mm

TROLLEYS SMART 073



TROLLEY WITHOUT CONTAINERS

ORD. NO.	DIMENSIONS mm
F LB B073 02 52	725x613x1430 h
Complete with:	
2 shelves depth 420 mm (A=687 mm)	
2 pairs of partial profiles for practibox	
2 swivel wheels with brake Ø 125 mm	
2 fixed standard rubber wheels Ø 125 mm	
Load capacity: 300 kg (150 kg per side)	
Standard colour:	
■ ■ 52	

TROLLEY WITH CONTAINERS

ORD. NO.	DIMENSIONS mm
F LB B073 52 52	725x613x1430 h
Complete with:	
1 trolley ORD. NO. F LB B073 02 52	
2 drawer cabinets with 6 practibox drawers	
2 drawer cabinets with 5 practibox drawers	
2 containers ORD. NO. F PA 4451 A0 01	
1 container ORD. NO. F PA 6451 A0 01	
1 container ORD. NO. F PA 6851 A0 01	

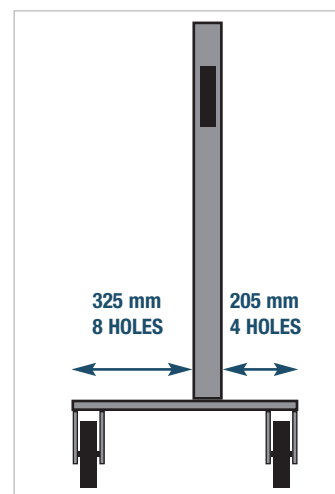

- Tilting shelves load capacity 50 kg each
- Partial frame load capacity 50 kg each

GALVANISED + RAL 7000 F.52

KEY

- Trolleys are supplied fitted with wheels and frame to be assembled
- Possibility of using uprights – height 1772 mm (see page D20)
- Accessories and material stored on the trolleys must not overhang the base of the trolley
- All indicated loads are net and refer to evenly distributed weights



■ Containers see page G2

■ Practibox see page D17



LENGTH = 725 mm DEPTH = 613 mm

TROLLEYS SERIES SMART 073

TROLLEYS SMART 073



Front

- Tilting shelves load capacity 50 kg each
- Partial frame load capacity 50 kg each

TROLLEY WITHOUT CONTAINERS

ORD. NO.	DIMENSIONS mm
F LB B073 03 52	725x613x1430 h
Complete with:	
6 shelves depth 220 mm (A=687 mm)	
4 pairs of partial profiles for practibox	
2 swivel wheels with brake Ø 125 mm	
2 fixed standard rubber wheels Ø 125 mm	
Load capacity: 300 kg (150 kg per side)	
Standard colour:	
■ ■ 52	



Rear

TROLLEY WITH CONTAINERS

ORD. NO.	DIMENSIONS mm
F LB B073 53 52	725x613x1430 h
Complete with:	
1 trolley ORD. NO. F LB B073 03 52	
4 drawer cabinets with 6 practibox drawers	
4 drawer cabinets with 5 practibox drawers	
12 containers ORD. NO. F PA 2451 A0 01	

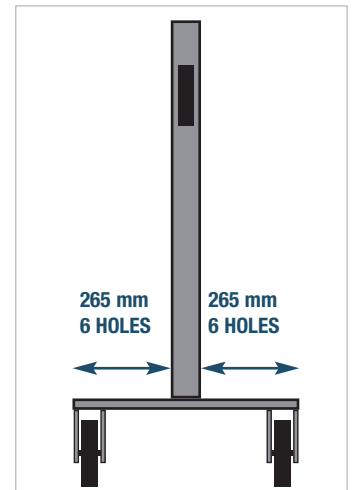

TROLLEYS SMART 073



Front

Load capacity:
Fixed shelves 25 kg

- Fixed shelves load capacity 25 kg each

TROLLEY WITHOUT CONTAINERS

ORD. NO.	DIMENSIONS mm
F LB B073 04 52	725x613x1430 h
Complete with:	
2 pairs of partial profiles for practibox	
2 swivel wheels with brake Ø 125 mm	
2 fixed standard rubber wheels Ø 125 mm	
Load capacity: 300 kg (150 kg per side)	
Standard colour:	
■ ■ 52	



Rear

TROLLEY WITH CONTAINERS

ORD. NO.	DIMENSIONS mm
F LB B073 54 52	725x613x1430 h
Complete with:	
1 trolley ORD. NO. F LB B073 04 52	
4 drawer cabinets with 9 practibox drawers	
6 drawer cabinets with 6 practibox drawers	
4 drawer cabinets with 5 practibox drawers	
2 drawer cabinets with 4 practibox drawers	
2 drawer cabinets with 3 practibox drawers	

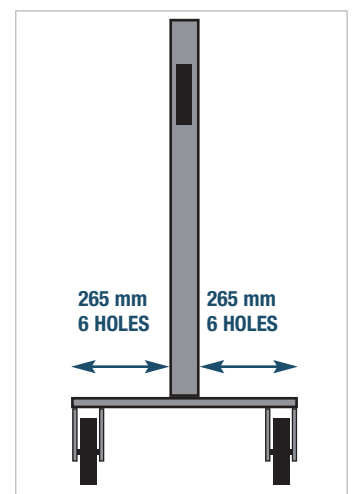

■ KEY



- Trolleys are supplied fitted with wheels and frame to be assembled
- Possibility of using uprights – height 1772 mm (see page D20)
- Accessories and material stored on the trolleys must not overhang the base of the trolley
- All indicated loads are net and refer to evenly distributed weights

■ Containers see page G2

■ Practibox see page D17

GALVANISED + RAL 7000 F... ..52

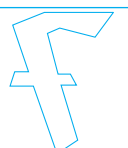

TROLLEYS SERIES SMART 073

TROLLEYS SMART 073



Front

■ Tilting shelves load capacity 50 kg each

TROLLEY WITHOUT CONTAINERS

ORD. NO.	DIMENSIONS mm
F LB B073 05 52	725x613x1430 h
Complete with:	
3 shelves depth 420 mm (A=687 mm)	
2 swivel wheels with brake Ø 125 mm	
2 fixed standard rubber wheels Ø 125 mm	
Load capacity: 300 kg (150 kg per side)	
Standard colour:	
■ ■ 52	

TROLLEY WITH CONTAINERS

ORD. NO.	DIMENSIONS mm
F LB B073 55 52	725x613x1430 h
Complete with:	
1 trolley ORD. NO. F LB B073 05 52	
4 containers ORD. NO. F PA 4451 A0 01	
1 container ORD. NO. F PA 6451 A0 01	
1 container ORD. NO. F PA 6851 A0 01	

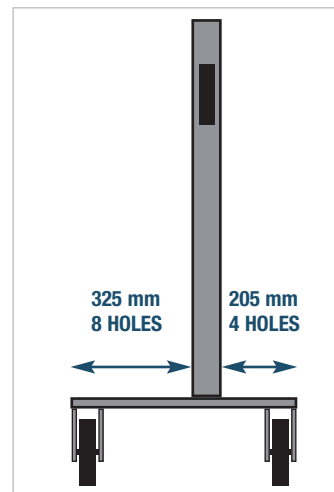

2A STIFFENING BAR

ORD. NO.	LENGTH mm
F BL 4500 00 01	713 (A=687)
Standard colour: ■ 01	

The bar (ref. 2) can be mounted under the shelf (depth 420 / 600 mm) to increase the load capacity of the shelf from 50 to 100 kg.

■ The B073 series trolleys are supplied with 2 stiffening bars



Example of use of the LB Unimod series trolleys

GALVANISED + RAL 7000 F.52 RAL 7000 F.01

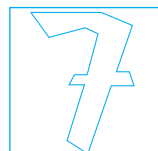

■ Containers see page G2

KEY ■

- Trolleys are supplied fitted with wheels and frame to be assembled
- Possibility of using uprights – height 1772 mm (see page D20)
- Accessories and material stored on the trolleys must not overhang the base of the trolley
- All indicated loads are net and refer to evenly distributed weights



LENGTH = 725 / 1023 mm DEPTH = 613 mm

TROLLEYS SERIES SMART

TROLLEYS SMART

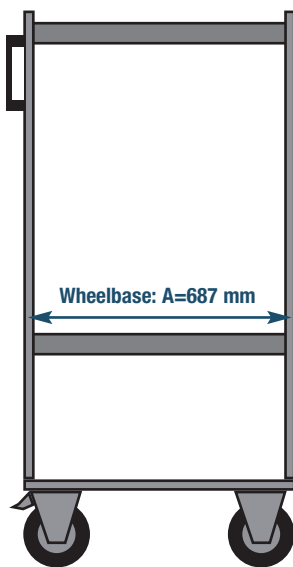
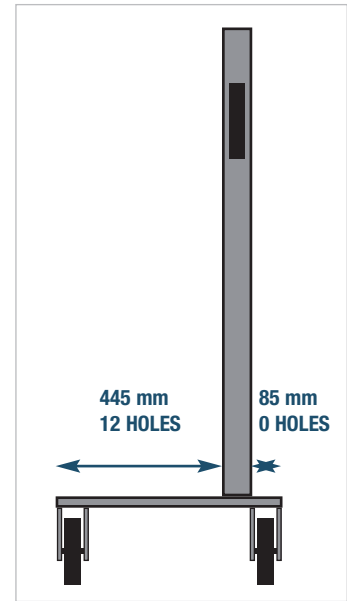
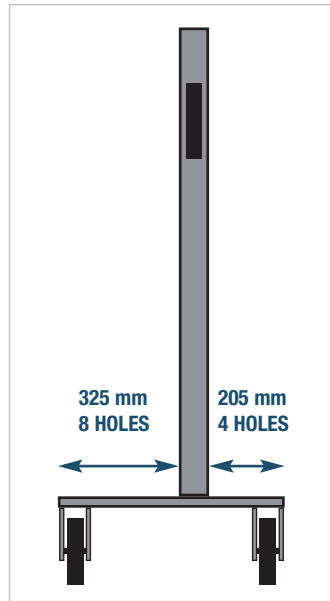
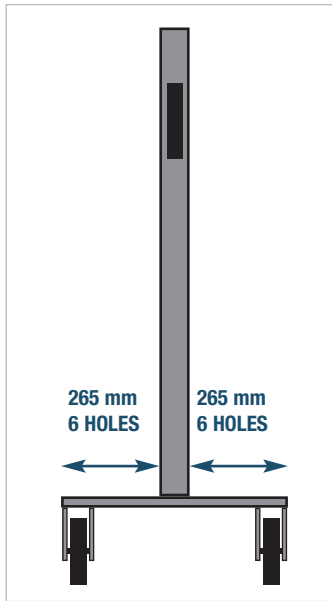

TROLLEYS SMART 073

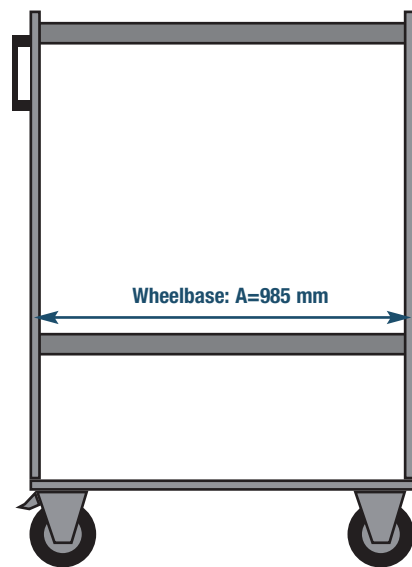

TROLLEYS SMART 101

TROLLEYS SMART 102

TROLLEYS SMART 103

KEY



- Trolleys are supplied fitted with wheels and frame to be assembled
- Possibility of using uprights – height 1772 mm (see page D20)
- Accessories and material stored on the trolleys must not overhang the base of the trolley
- All indicated loads are net and refer to evenly distributed weights

GALVANISED + RAL 7000 F. 52

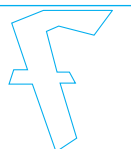

TROLLEYS SERIES SMART

TROLLEYS SMART

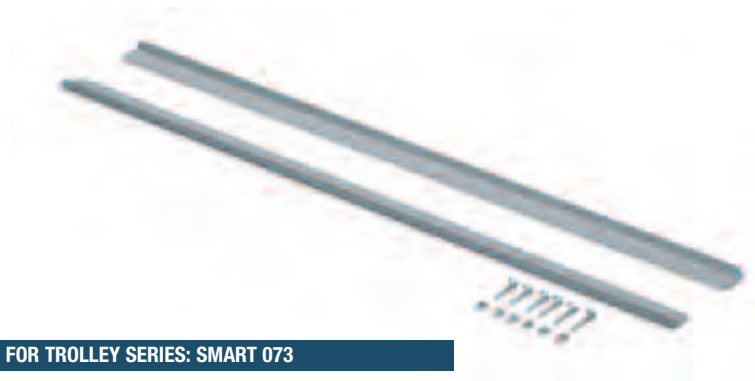

FOR TROLLEY SERIES: SMART 073

PAIR OF PROFILES FOR PRACTIBOX

ORD. NO.

HEIGHT mm

F BL 4430 00 01

1200 (A=687)

Pair of profiles for Practibox for one side of the trolley

Standard colour: ■ 01



FOR TROLLEY SERIES: SMART 073

PAIR OF PARTIAL PROFILES FOR PRACTIBOX

ORD. NO.

HEIGHT mm

F BL 4425 00 52

280 (A=687)

Pair of profiles for Practibox complete with bottom support for one side of the trolley

Standard colour:

■ ■ 52



 GALVANISED + RAL 7000 F. 52
  RAL 7000 F. 01

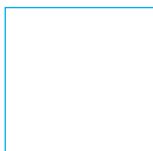
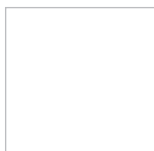
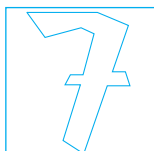

KEY ■

- Trolleys are supplied fitted with wheels and frame to be assembled
- Possibility of using uprights – height 1772 mm (see page D20)
- Accessories and material stored on the trolleys must not overhang the base of the trolley
- All indicated loads are net and refer to evenly distributed weights



LENGTH = 725 / 1023 mm DEPTH = 613 mm

TROLLEYS SERIES SMART

TROLLEYS SMART



PRACTIBOX DRAWER CABINET

ORD. NO.	DIMENSIONS mm
F PG 1071 01 01	600x69x77 h
Cabinet with 9 drawers	



PRACTIBOX DRAWER CABINET

ORD. NO.	DIMENSIONS mm
F PG 1571 01 01	600x98x112 h
Cabinet with 6 drawers	



PRACTIBOX DRAWER CABINET

ORD. NO.	DIMENSIONS mm
F PG 2071 01 01	600x141x164 h
Cabinet with 5 drawers	

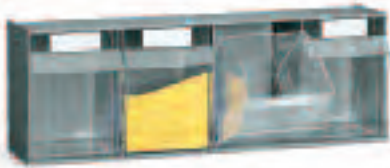

PRACTIBOX DRAWER CABINET

ORD. NO.	DIMENSIONS mm
F PG 2571 01 01	600x174x206 h
Cabinet with 4 drawers	



PRACTIBOX DRAWER CABINET

ORD. NO.	DIMENSIONS mm
F PG 3071 01 01	600x209x240 h
Cabinet with 3 drawers	



FOR TROLLEY SERIES: SMART 101-102-103

ROLLER SHUTTER CABINET

ORD. NO.	DEPTH mm		
F BL 7011 02 01	190		
To fix to dual slot uprights			
Overall dim.: 952x210x810 h mm			
Usable dim.: 905x150x581 h mm			
Load capacity 50 kg			
Colours available:			
01	02	51	56

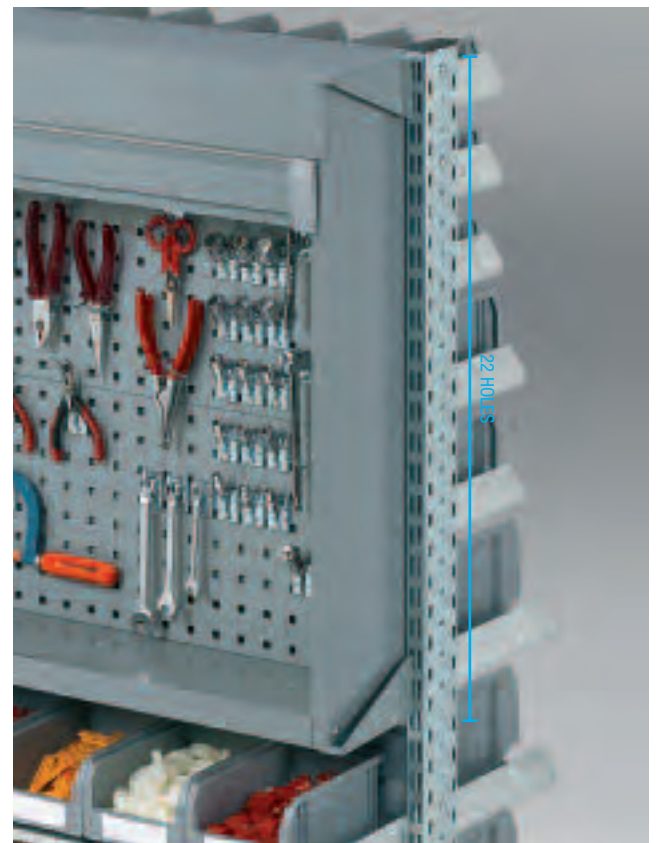

KEY



- Trolleys are supplied fitted with wheels and frame to be assembled
- Possibility of using uprights – height 1772 mm (see page D20)
- Accessories and material stored on the trolleys must not overhang the base of the trolley
- All indicated loads are net and refer to evenly distributed weights

RAL 7000 F.01 RAL 6011 F.02 RAL 5012 + RAL 7000 F.51 RAL 7035 + RAL 7000 F.56

Hooks see page C66

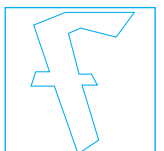
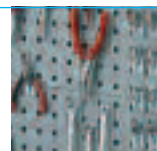

TROLLEYS SERIES SMART

TROLLEYS SMART



FOR TROLLEY SERIES: SMART 101-102-103

PERFORATED PANEL

ORD. NO.	LENGTH mm
----------	-----------

F BL 7620 00 01	973 (A=985)
-----------------	-------------

Perforated panel that can be hooked onto the dual slot uprights

Colours available:

01	02	04	08
----	----	----	----



FOR TROLLEY SERIES: SMART 101-102-103

TILTING SHELVES LENGTH 955 mm

ORD. NO.	DEPTH mm
----------	----------

F BL 7750 00 99	220 (A=985)
-----------------	-------------

F BL 7755 00 99	320 (A=985)
-----------------	-------------

F BL 7760 00 99	420 (A=985)
-----------------	-------------

F BL 7762 00 99	600 (A=985)
-----------------	-------------

Load capacity 50 kg

Colours available:

01	02	04	08	99 GALVANISED
----	----	----	----	---------------



FOR TROLLEY SERIES: SMART 073

TILTING SHELF LENGTH 657 mm

ORD. NO.	DEPTH mm
----------	----------

F BL 7820 00 99	220 (A=687)
-----------------	-------------

F BL 7830 00 99	420 (A=687)
-----------------	-------------

Load capacity 50 kg

Standard colour:

99 GALVANISED

RAL 7000 F.01	RAL 6011 F.02	RAL 5012 F.04	RAL 7035 F.08
--------------------	--------------------	--------------------	--------------------

KEY ■



■ Hooks see page C66

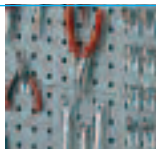

- Trolleys are supplied fitted with wheels and frame to be assembled
- Possibility of using uprights – height 1772 mm (see page D20)
- Accessories and material stored on the trolleys must not overhang the base of the trolley
- All indicated loads are net and refer to evenly distributed weights



LENGTH = 725 / 1023 mm DEPTH = 613 mm

TROLLEYS SERIES SMART

TROLLEYS SMART

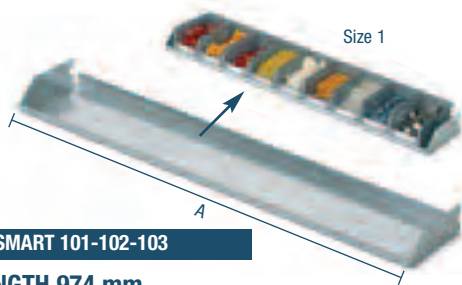

FOR TROLLEY SERIES: SMART 101-102-103

FIXED SHELF LENGTH 974 mm

ORD. NO. DEPTH mm

F BL 7846 00 99 150 (A=985)

Dimensions: 974x170x61 mm h

Load capacity 25 kg. Capacity: 9 containers size 1

Standard colour:

■ 99 GALVANISED

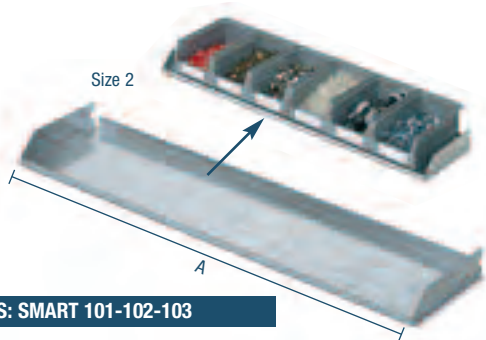

FOR TROLLEY SERIES: SMART 101-102-103

FIXED SHELF LENGTH 974 mm

ORD. NO. DEPTH mm

F BL 7847 00 99 205 (A=985)

Dimensions: 974x230x61 mm h

Load capacity 25 kg. Capacity: 6 containers size 2

Standard colour:

■ 99 GALVANISED

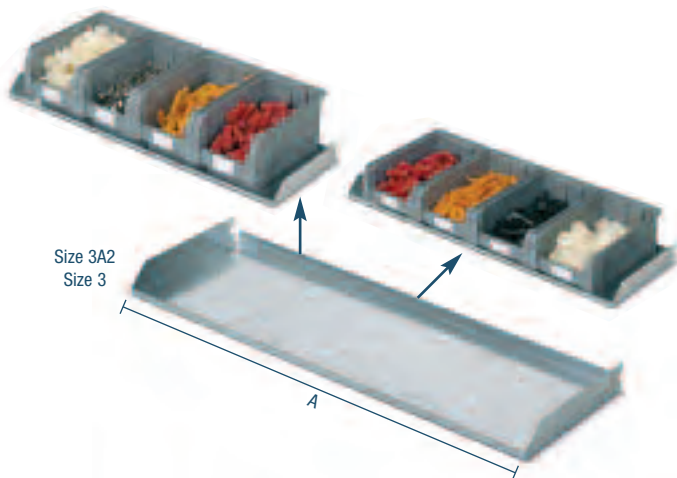

FOR TROLLEY SERIES: SMART 101-102-103

FIXED SHELF LENGTH 974 mm

ORD. NO. DEPTH mm

F BL 7848 00 99 295 (A=985)

Dimensions: 974x315x61 mm h

Load capacity 25 kg. Capacity: 4 containers size 3A2 / size 3

Standard colour:

■ 99 GALVANISED

■ KEY



- Trolleys are supplied fitted with wheels and frame to be assembled
- Possibility of using uprights – height 1772 mm (see page D20)
- Accessories and material stored on the trolleys must not overhang the base of the trolley
- All indicated loads are net and refer to evenly distributed weights

■ GALVANISED
F. 99



TROLLEYS SERIES SMART

TROLLEYS SMART

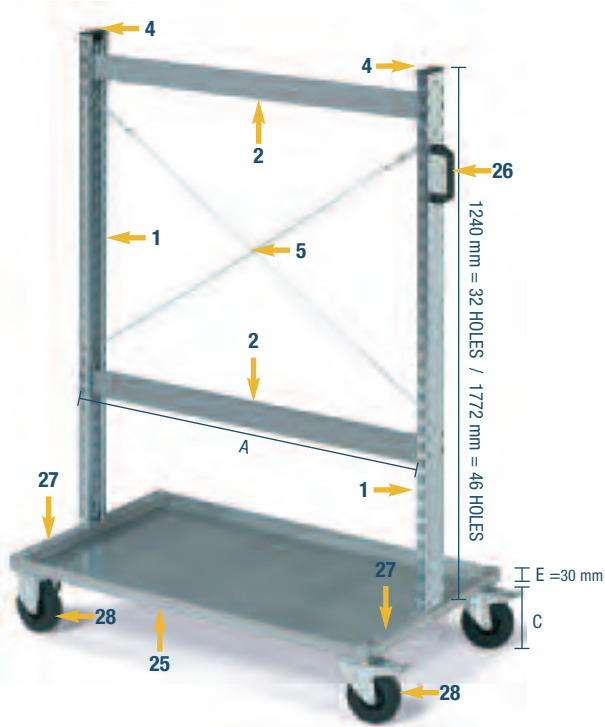

TROLLEYS SERIES: SMART 101-102-103

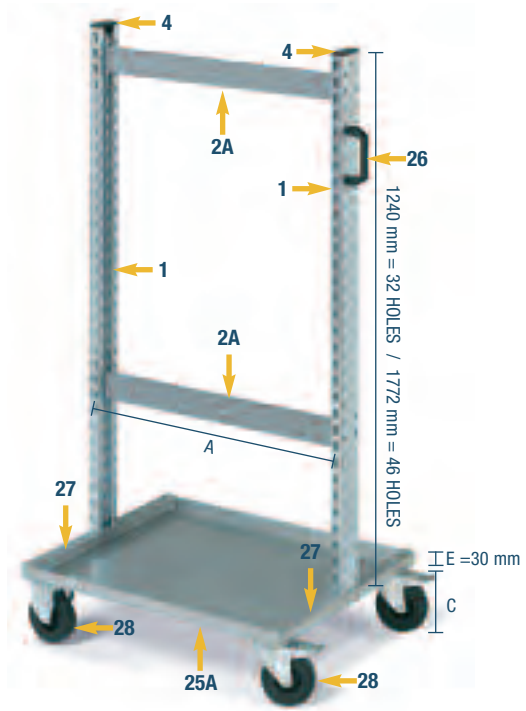

TROLLEYS SERIES: SMART 073

1 DUAL SLOT UPRIGHT

ORD. NO.	HEIGHT mm
F BL 7540 01 99	1240
F BL 7547 01 99	1772

Colours available:

- 01 ■ 02 ■ 04 ■ 08 ■ 99 GALVANISED

4 PAIR OF CAPS

ORD. NO.
F BL 4420 00 07

Standard colour: ■ 07

25A BASE

ORD. NO.	DIMENSIONS mm
F BL 4400 00 99	725x613x32 h (A=687)

Standard colour: ■ 99 GALVANISED

2 STIFFENING BAR

ORD. NO.	LENGTH mm
F BL 4505 00 01	1011 (A=985)

Standard colour: ■ 01

5 CROSS BRACING

ORD. NO.	MODULE mm
F BL 4705 00 99	A=985 / H=1240
F BL 4720 00 99	A=985 / H=1772

Standard colour: ■ 99 GALVANISED

26 HANDLE

ORD. NO.
F BL 4415 00 07

Standard colour: ■ 07

2A STIFFENING BAR

ORD. NO.	LENGTH mm
F BL 4500 00 01	713 (A=687)

Standard colour: ■ 01

25 BASE

ORD. NO.	DIMENSIONS mm
F BL 4405 00 99	1023x613x32 h (A=985)

Standard colour: ■ 99 GALVANISED

27 BASE BAR

ORD. NO.	DIMENSIONS mm
F BL 4410 00 01	604x30x30 h

Standard colour: ■ 01

- RAL 7000 F...01
- RAL 6011 F...02
- RAL 5012 F...04
- RAL 7035 F...08
- RAL 9011 F...07

KEY

- Trolleys are supplied fitted with wheels and frame to be assembled
- Possibility of using uprights – height 1772 mm (see page D20)
- Accessories and material stored on the trolleys must not overhang the base of the trolley
- All indicated loads are net and refer to evenly distributed weights

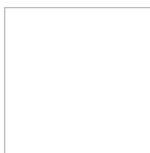
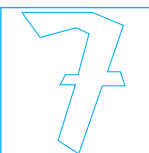

■ Hooks see page C66



28 STANDARD RUBBER

SWIVEL WHEEL WITH BRAKE



ORD. NO.	Ø mm	C mm
C RG DAC12 125	125	160
C RG DAC13 150	150	185

FIXED WHEEL



ORD. NO.	Ø mm	C mm
C RG BAC12 125	125	160
C RG BAC13 150	150	185

28 NYLON

SWIVEL WHEEL WITH BRAKE



ORD. NO.	Ø mm	C mm
C RN DAD10 100	100	130
C RN DAD11 125	125	160

FIXED WHEEL



ORD. NO.	Ø mm	C mm
C RN BAD10 100	100	130
C RN BAD11 125	125	160

28 SYNTHETIC NO-SMEAR RUBBER

SWIVEL WHEEL WITH BRAKE



ORD. NO.	Ø mm	C mm
C RG DPH22 125	125	160

FIXED WHEEL



ORD. NO.	Ø mm	C mm
C RG BPH22 125	125	160

28 ELASTIC RUBBER

SWIVEL WHEEL WITH BRAKE



ORD. NO.	Ø mm	C mm
C RG DCE15 125	125	160

FIXED WHEEL



ORD. NO.	Ø mm	C mm
C RG BCE15 125	125	160

28 POLYURETHANE

SWIVEL WHEEL WITH BRAKE



ORD. NO.	Ø mm	C mm
C RN DDD31 125	125	160

FIXED WHEEL



ORD. NO.	Ø mm	C mm
C RN BDD31 125	125	160

■ KEY



- Trolleys are supplied fitted with wheels and frame to be assembled
- Maximum height of dual slot uprights that can be used 1772 mm
- Accessories and material stored on the trolleys must not overhang the base of the trolley

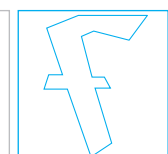
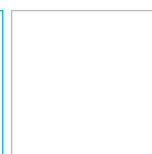



ORD. NO. F LC C173 S1 52
GALVANISED

FLOOR FIXING SET

■ 99 GALVANISED



■ 2 dowels suitable for uncracked concrete class B25/RBK250/MPA 25 N/mm²
Dowel diameter: Ø 6x85 mm

ORD. NO. F BL 8999 00 99

WALL FIXING SET

■ 99 GALVANISED



Wall fixing bracket for dual slot uprights
Articulated, complete with bolts and screws
Dowels not included

ORD. NO. F BL 8998 00 99

SHELVING SYSTEM

ORD. NO.	DIMENSIONS mm
F LC C173 S1 52	2052x542x1817 h
Complete with:	
1 single sided base frame ORD. NO. F LC C173 00 52	
1 addit. single sided frame ORD. NO. F LC D173 00 52	
8 shelves for size 1, 6 shelves for size 2	
2 shelves for size 3A2	
4 shelves depth 420 mm (A=985 mm)	
Tools and containers excluded	
Standard colour:	
■ GALVANISED + RAL 7000 F.52	

GALVANISED + RAL 7000 F.52

KEY ■

- Shelves are supplied not assembled
- Shelves must be fixed to the wall or floor
- All indicated loads are net and refer to evenly distributed weights



LENGTH = 1067 mm DEPTH = 542 / 925 mm

SHELVING SYSTEMS SERIES SLICK

SHELVING SYSTEM SLICK



Front

■ Tilting shelves load capacity 50 kg each

SHELF WITHOUT CONTAINERS

ORD. NO.	DIMENSIONS mm
----------	---------------

F LC C173 01 52	1067x542x1817 h
------------------------	------------------------

Complete with:

5 shelves depth 420 mm (A=985 mm)

Load capacity: 150 kg

Standard colour:

■ ■ 52

SHELF WITH CONTAINERS

ORD. NO.	DIMENSIONS mm
----------	---------------

F LC C173 51 52	1067x542x1817 h
------------------------	------------------------

Complete with:

1 shelf ORD. NO. F LC C173 01 52

9 containers ORD. NO. F PA 4451 A0 01

3 containers ORD. NO. F PA 6451 A0 01



Front

■ Tilting shelves load capacity 50 kg each

SHELF WITHOUT CONTAINERS

ORD. NO.	DIMENSIONS mm
----------	---------------

F LC A173 01 52	1067x925x1817 h
------------------------	------------------------

Complete with:

10 shelves depth 420 mm (A=985 mm)

Load capacity: 300 kg (150 kg per side)

Standard colour:

■ ■ 52

SHELF WITH CONTAINERS

ORD. NO.	DIMENSIONS mm
----------	---------------

F LC A173 51 52	1067x925x1817 h
------------------------	------------------------

Complete with:

1 shelf ORD. NO. F LC A173 01 52

18 containers ORD. NO. F PA 4451 A0 01

6 containers ORD. NO. F PA 6451 A0 01



Rear

■ KEY



- Shelves are supplied not assembled
- Shelves must be fixed to the wall or floor
- All indicated loads are net and refer to evenly distributed weights

■ Containers see page G2

GALVANISED + RAL 7000 F... ..52

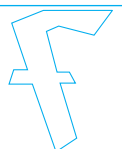

SHELVING SYSTEMS SERIES SLICK

SHELVING SYSTEM SLICK



Front

- Fixed shelves load capacity 25 kg each

SHELF WITHOUT CONTAINERS

ORD. NO.	DIMENSIONS mm
----------	---------------

F LC C173 02 52	1067x542x1817 h
------------------------	------------------------

Complete with:

7 shelves for size 1

6 shelves for size 2

Load capacity: 150 kg**Standard colour:**

■ ■ 52

SHELF WITH CONTAINERS

ORD. NO.	DIMENSIONS mm
----------	---------------

F LC C173 52 52	1067x542x1817 h
------------------------	------------------------

Complete with:

1 shelf ORD. NO. F LC C173 02 52

63 containers size 1

36 containers size 2



Front

- Fixed shelves load capacity 25 kg each

SHELF WITHOUT CONTAINERS

ORD. NO.	DIMENSIONS mm
----------	---------------

F LC A173 02 52	1067x925x1817 h
------------------------	------------------------

Complete with:

14 shelves for size 1

12 shelves for size 2

Load capacity: 300 kg (150 kg per side)**Standard colour:**

■ ■ 52

SHELF WITH CONTAINERS

ORD. NO.	DIMENSIONS mm
----------	---------------

F LC A173 52 52	1067x925x1817 h
------------------------	------------------------

Complete with:

1 shelf ORD. NO. F LC A173 02 52

126 containers size 1

72 containers size 2



Rear

GALVANISED + RAL 7000 F... ..52

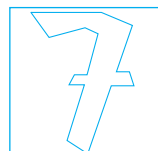

- Containers see page **G28 - G30**

KEY ■

- Shelves are supplied not assembled
- Shelves must be fixed to the wall or floor
- All indicated loads are net and refer to evenly distributed weights



LENGTH = 1067 mm DEPTH = 542 / 925 mm

SHELVING SYSTEMS SERIES SLICK

SHELVING SYSTEM SLICK



Front

■ Fixed shelves load capacity 25 kg each

SHELF WITHOUT CONTAINERS

ORD. NO.	DIMENSIONS mm
----------	---------------

F LC C173 03 52	1067x542x1817 h
------------------------	------------------------

Complete with:

5 shelves for size 1

5 shelves for size 2

2 shelves for size 3A2

Load capacity: 150 kg

Standard colour:

■ ■ 52

SHELF WITH CONTAINERS

ORD. NO.	DIMENSIONS mm
----------	---------------

F LC C173 53 52	1067x542x1817 h
------------------------	------------------------

Complete with:

1 shelf ORD. NO. F LC C173 03 52

45 containers size 1

30 containers size 2

8 containers size 3A2



Front

■ Fixed shelves load capacity 25 kg each

SHELF WITHOUT CONTAINERS

ORD. NO.	DIMENSIONS mm
----------	---------------

F LC A173 03 52	1067x925x1817 h
------------------------	------------------------

Complete with:

10 shelves for size 1

10 shelves for size 2

4 shelves for size 3A2

Load capacity: 300 kg (150 kg per side)

Standard colour:

■ ■ 52

SHELF WITH CONTAINERS

ORD. NO.	DIMENSIONS mm
----------	---------------

F LC A173 53 52	1067x925x1817 h
------------------------	------------------------

Complete with:

1 shelf ORD. NO. F LC A173 03 52

90 containers size 1

60 containers size 2

16 containers size 3A2



Rear

■ KEY



- Shelves are supplied not assembled
- Shelves must be fixed to the wall or floor
- All indicated loads are net and refer to evenly distributed weights

■ Containers see page **G28 - G30**



GALVANISED + RAL 7000 F... ..52

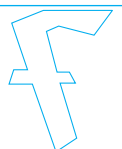

SHELVING SYSTEMS SERIES SLICK

LENGTH = 1067 mm DEPTH = 542 / 925 mm

SHELVING SYSTEM SLICK



Front

- Fixed shelves load capacity 25 kg each
- Tilting shelves load capacity 50 kg each

SHELF WITHOUT CONTAINERS

ORD. NO.	DIMENSIONS mm
----------	---------------

F LC C173 04 52	1067x542x1817 h
------------------------	------------------------

Complete with:

4 shelves for size 2

3 shelves for size 3A2

2 shelves depth 420 mm (A=985 mm)

Load capacity: 150 kg

Standard colour:

■ ■ 52

SHELF WITH CONTAINERS

ORD. NO.	DIMENSIONS mm
----------	---------------

F LC C173 54 52	1067x542x1817 h
------------------------	------------------------

Complete with:

1 shelf ORD. NO. F LC C173 04 52

24 containers size 2

12 containers size 3A2

3 containers size 4A2

3 containers size 4



Front

- Fixed shelves load capacity 25 kg each
- Tilting shelves load capacity 50 kg each

SHELF WITHOUT CONTAINERS

ORD. NO.	DIMENSIONS mm
----------	---------------

F LC A173 04 52	1067x925x1817 h
------------------------	------------------------

Complete with:

8 shelves for size 2

6 shelves for size 3A2

4 shelves depth 420 mm (A=985 mm)

Load capacity: 300 kg (150 kg per side)

Standard colour:

■ ■ 52

SHELF WITH CONTAINERS

ORD. NO.	DIMENSIONS mm
----------	---------------

F LC A173 54 52	1067x925x1817 h
------------------------	------------------------

Complete with:

1 shelf ORD. NO. F LC A173 04 52

48 containers size 2

24 containers size 3A2

6 containers size 4A2

6 containers size 4



Rear

GALVANISED + RAL 7000 F... ..52



■ Containers
see page
G28 - G30

KEY ■

- Shelves are supplied not assembled
- Shelves must be fixed to the wall or floor
- All indicated loads are net and refer to evenly distributed weights



LENGTH = 1067 mm DEPTH = 542 / 925 mm

SHELVING SYSTEMS SERIES SLICK

SHELVING SYSTEM SLICK DOUBLE SIDED BASE FRAME WITH CROSS BRACING

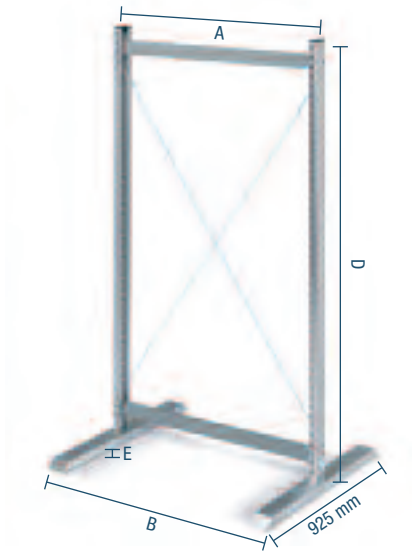

ORD. NO.	A mm	B mm	D mm	E mm
F LC A173 00 52	985	1067	1772	40
Load capacity of 1 upright: 150 kg (75 kg per side)				
Standard colour:				
■ ■ 52				

ADDITIONAL DOUBLE SIDED FRAME WITH CROSS BRACING

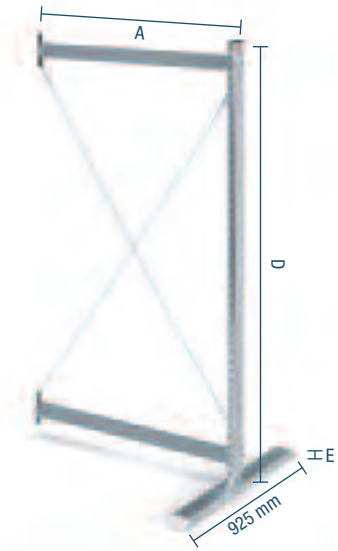

ORD. NO.	A mm	B mm	D mm	E mm
F LC B173 00 52	985	-	1772	40
Load capacity of 1 upright: 150 kg (75 kg per side)				
Standard colour:				
■ ■ 52				

SINGLE SIDED BASE FRAME WITH CROSS BRACING

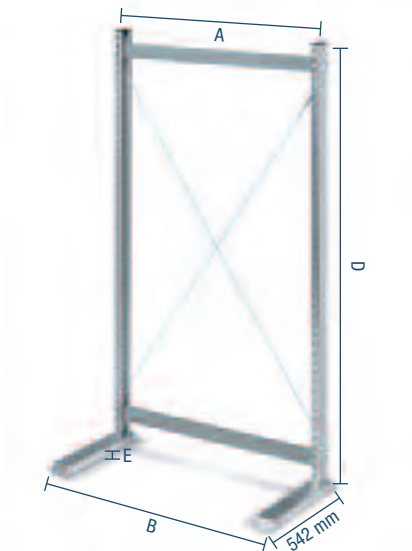

ORD. NO.	A mm	B mm	D mm	E mm
F LC C173 00 52	985	1067	1772	40
Load capacity of 1 upright: 75 kg				
Standard colour:				
■ ■ 52				

ADDITIONAL SINGLE SIDED FRAME WITH CROSS BRACING

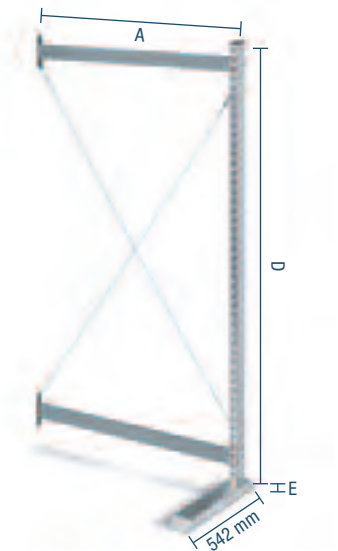

ORD. NO.	A mm	B mm	D mm	E mm
F LC D173 00 52	985	-	1772	40
Load capacity of 1 upright: 75 kg				
Standard colour:				
■ ■ 52				

KEY



- Shelves are supplied not assembled
- Shelves must be fixed to the wall or floor
- All indicated loads are net and refer to evenly distributed weights
- Accessories see page D68

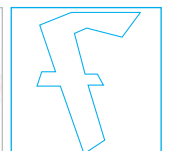
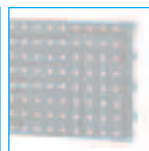

GALVANISED + RAL 7000 F... ..52

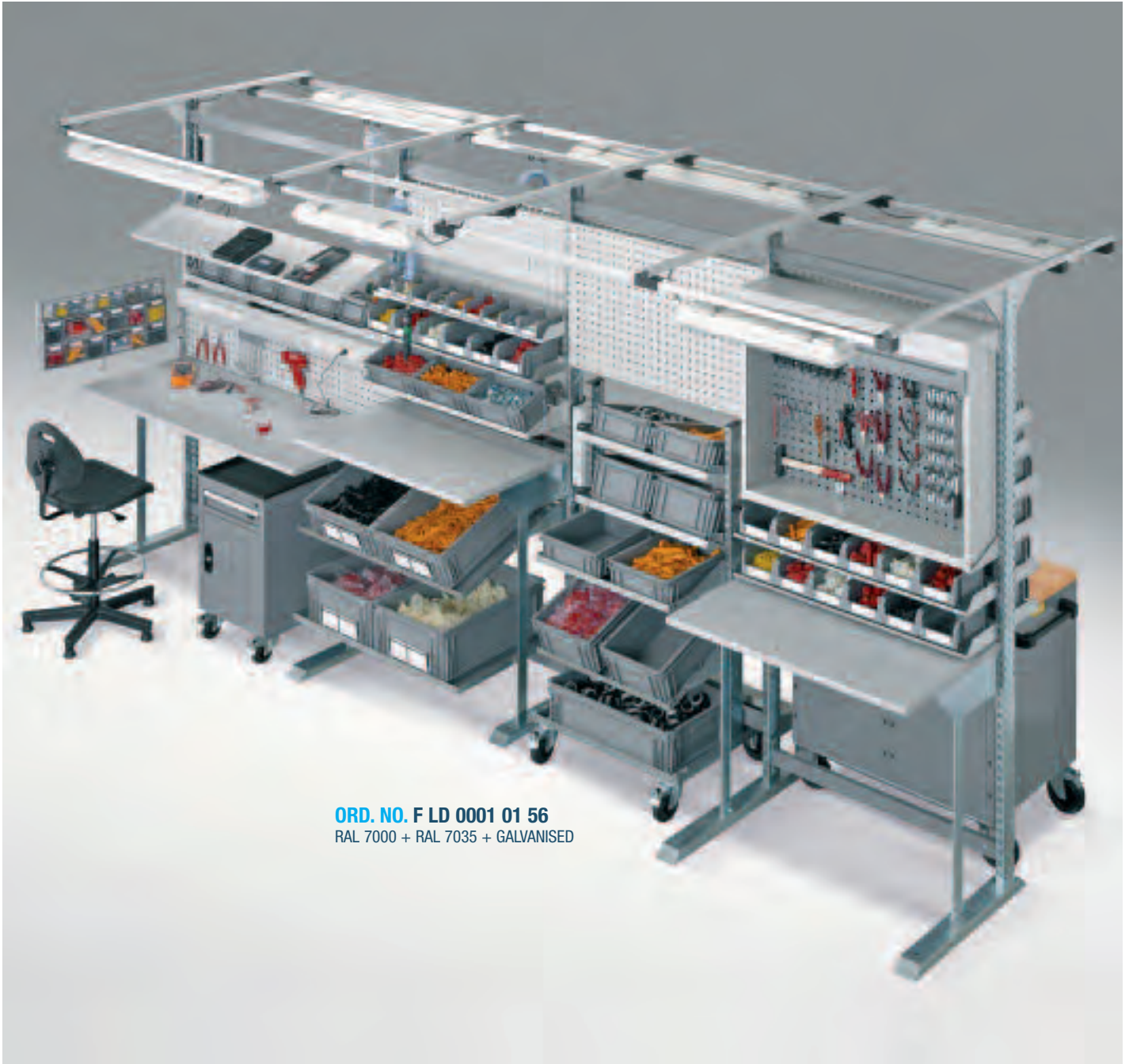

ORD. NO. F LD 0001 01 56
RAL 7000 + RAL 7035 + GALVANISED

FLOOR FIXING SET

■ 99 GALVANISED



■ 2 dowels suitable for uncracked concrete class B25/RBK250/MPA 25 N/mm²
Dowel diameter: Ø 6x85 mm

ORD. NO. F BL 8999 00 99

WALL FIXING SET

■ 99 GALVANISED



Wall fixing bracket for dual slot uprights
Articulated, complete with bolts and screws
Dowels not included

ORD. NO. F BL 8998 00 99

WORKSTATION SERIES COMFORT

ORD. NO. DIMENSIONS mm

F LD 0001 01 56 4507x1500x2220 h

Complete with: shelves, footrest, containers, boxes, perforated panels, supports with aluminium tracks, cabinets with wheels, mobile workstations, swivel arm with two joints, roller shutter cabinet, chairs, trolley series SMART.

Not included: pneumatic systems, electrical systems, lamps, hooks, tools and electrical tools.

Standard colour:

■ ■ ■ RAL 7000+RAL 7035+GALVANISED F.56

■ ■ ■ RAL 7000+RAL 7035+GALVANISED F.56

KEY ■

- Workstations are supplied not assembled
- Workstations must be fixed to the wall or floor
- All indicated loads are net and refer to evenly distributed weights



WORKSTATIONS SERIES COMFORT

WORKSTATIONS COMFORT



The base of the **COMFORT** series workstations is fitted with feet that are adjustable in height from **0** to **10** mm

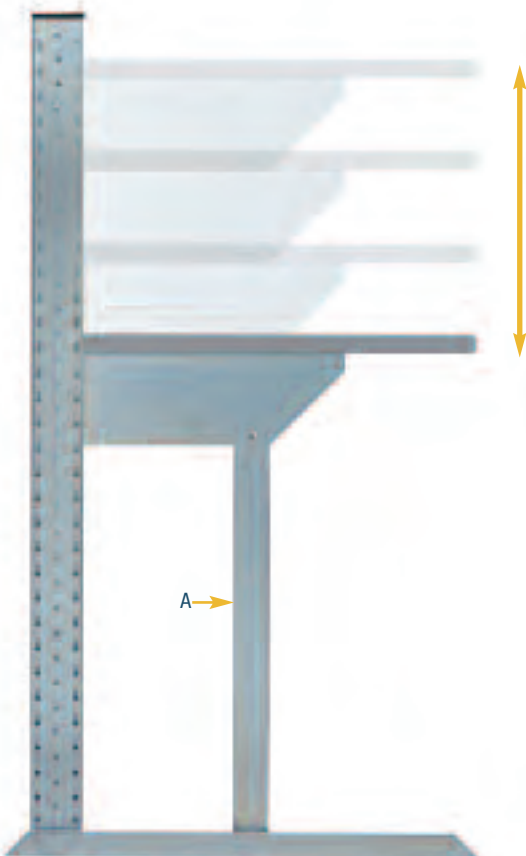

The height of the worktops of the **COMFORT** series workstations depends on the type of support used (ref. A).

One support adjusts the height of the worktop from 797 mm to 911 mm and the other one from 949 mm to 1063 mm.



The **COMFORT** series workstations have been designed to carry out any operation in a comfortable and functional way.

■ KEY



- Workstations are supplied not assembled
- Workstations must be fixed to the wall or floor
- All indicated loads are net and refer to evenly distributed weights



RAL 7000+RAL 7035+GALVANISED F.56

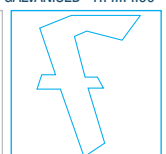
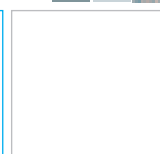

WORKSTATIONS SERIES COMFORT

LENGTH = 4507 mm DEPTH = 1500 mm

WORKSTATIONS COMFORT

■ ■ ■ 56



RAL 7000+RAL 7035+GALVANISED F.56

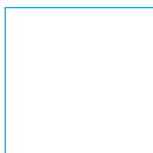
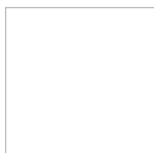
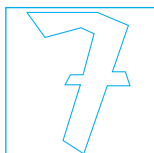

KEY ■

- Workstations are supplied not assembled
- Workstations must be fixed to the wall or floor
- All indicated loads are net and refer to evenly distributed weights



LENGTH = 4507 mm DEPTH = 1500 mm

WORKSTATIONS SERIES COMFORT

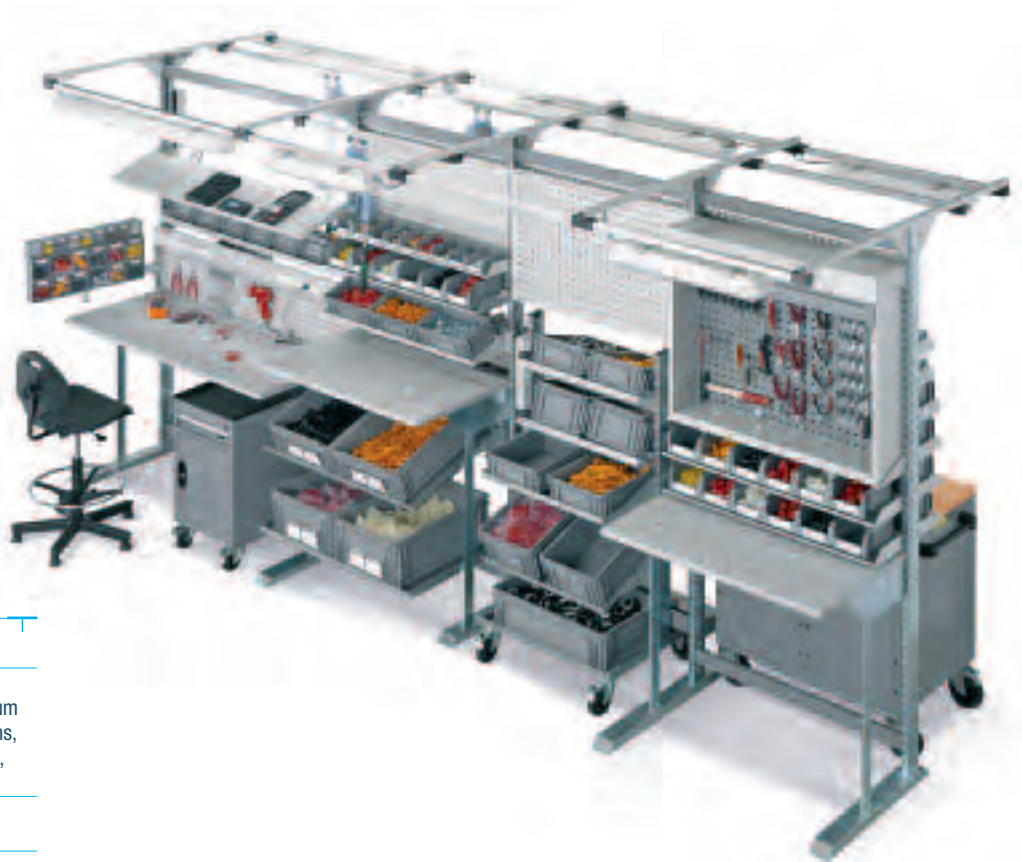
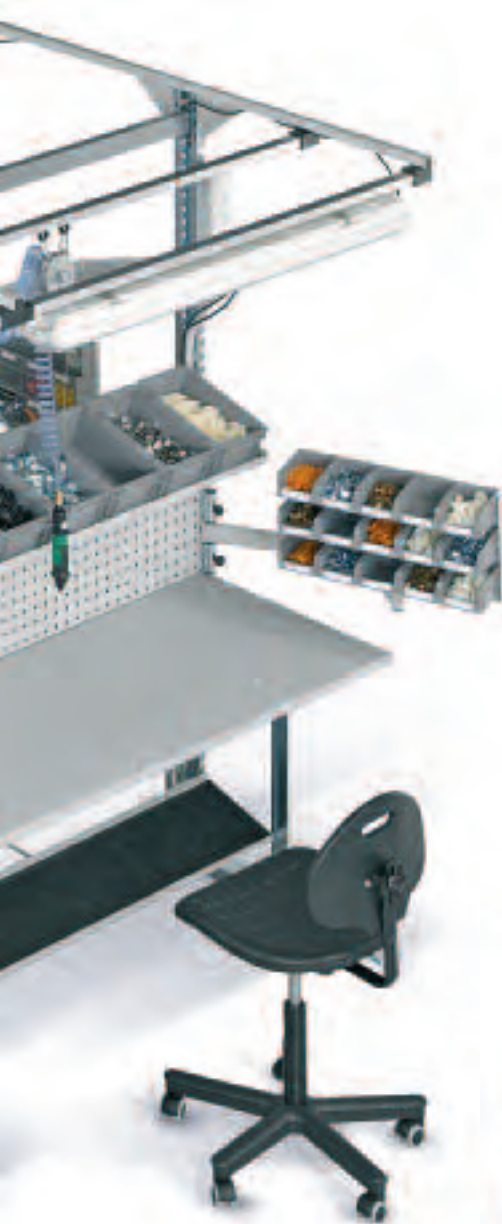

WORKSTATION SERIES COMFORT

ORD. NO. **DIMENSIONS mm**

F LD 0001 01 56 **4507x1500x2220 h**

Complete with: shelves, footrest, containers, boxes, perforated panels, supports with aluminium tracks, cabinets with wheels, mobile workstations, swivel arm with two joints, roller shutter cabinet, chairs, trolley series SMART

Not included: pneumatic systems, electrical systems, lamps, hooks, tools and electrical tools

Standard colour:



■ **KEY**



RAL 7000+RAL 7035+GALVANISED F.56



- Workstations are supplied not assembled
- Workstations must be fixed to the wall or floor
- All indicated loads are net and refer to evenly distributed weights

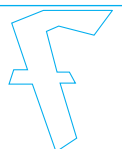

WORKSTATIONS SERIES COMFORT

LENGTH = 2052 mm DEPTH = 1500 mm

WORKSTATIONS COMFORT

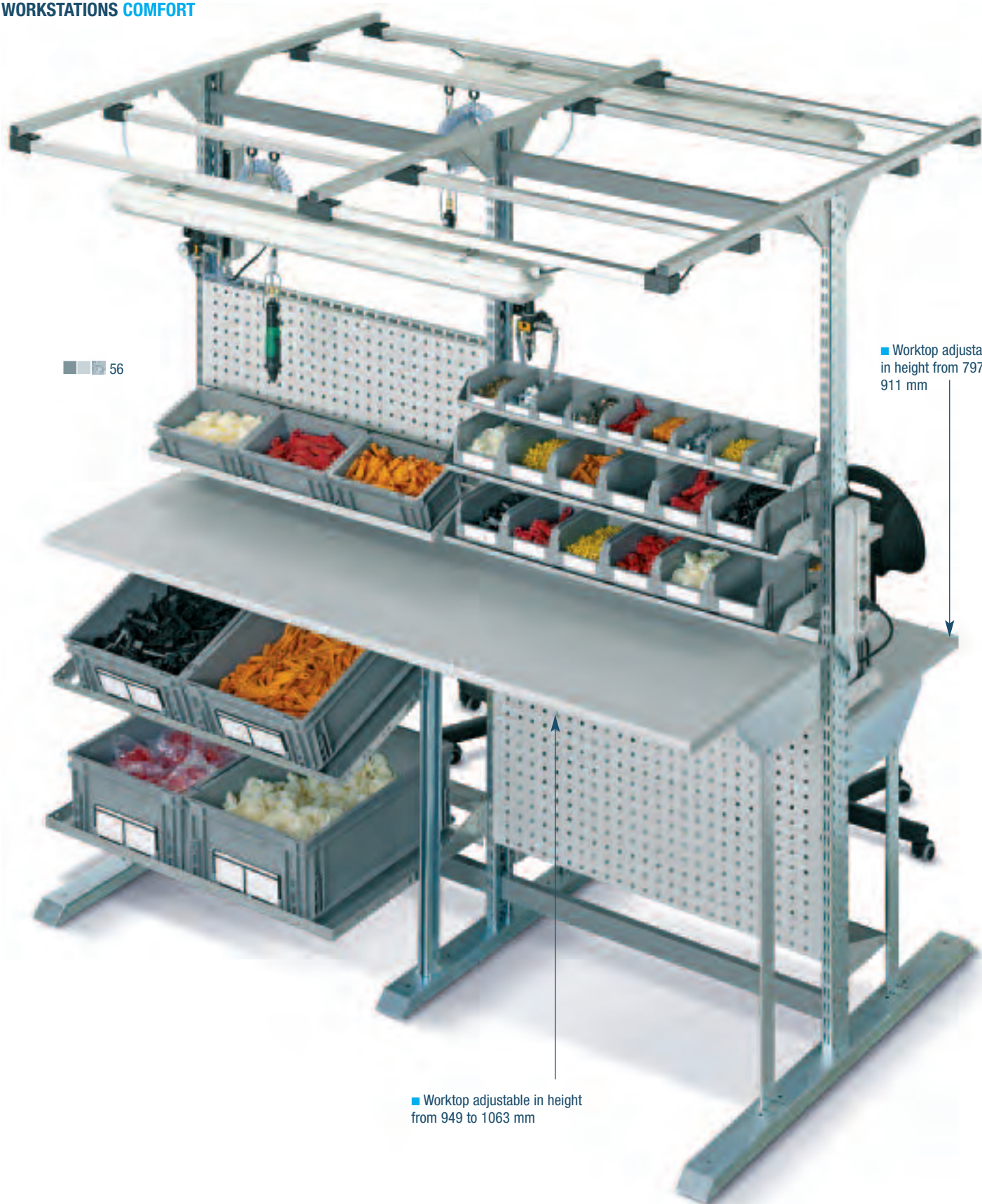

■ ■ ■ 56

■ Worktop adjustable in height from 797 to 911 mm

■ Worktop adjustable in height from 949 to 1063 mm

RAL 7000+RAL 7035+GALVANISED F.56

KEY ■

- Workstations are supplied not assembled
- Workstations must be fixed to the wall or floor
- All indicated loads are net and refer to evenly distributed weights

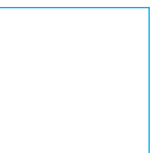
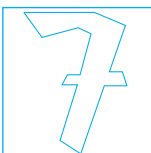

LENGTH = 2052 mm DEPTH = 1500 mm

WORKSTATIONS SERIES COMFORT

WORKSTATIONS COMFORT



WORKSTATION SERIES COMFORT

ORD. NO.	DIMENSIONS mm
----------	---------------

F LD 0001 02 56	2052x1500x2220 h
-----------------	------------------

Complete with: shelves, footrest, containers, boxes, perforated panels, supports with aluminium track, chairs

Not included: pneumatic systems, electrical systems, lamps, tools and electrical tools

Standard colour:

■ ■ ■ 56



■ KEY



- Workstations are supplied not assembled
- Workstations must be fixed to the wall or floor
- All indicated loads are net and refer to evenly distributed weights



RAL 7000+RAL 7035+GALVANISED F.56

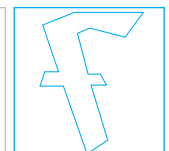
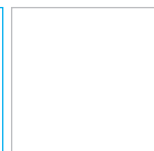

WORKSTATIONS SERIES COMFORT

LENGTH = 1067 mm DEPTH = 722 mm

WORKSTATIONS COMFORT



■ Worktop adjustable in height
from 797 to 911 mm

WORKSTATION SERIES COMFORT

ORD. NO.	DIMENSIONS mm
F LD 0001 03 56	1067x722x2220 h

Complete with: shelves, footrest, containers, boxes, perforated panels, supports with aluminium tracks, swivel arm with two joints, chair

Not included: pneumatic systems, electrical systems, lamps, tools and electrical tools

Standard colour:

■ ■ ■ 56

WORKSTATION SERIES COMFORT

ORD. NO.	DIMENSIONS mm
F LD 0001 04 56	1067x722x1285 h

Complete with: footrest, containers, perforated panels, chair

Not included: electrical system and lamp

Standard colour:

■ ■ ■ 56



■ Worktop adjustable in height
from 797 to 911 mm

RAL 7000+RAL 7035+GALVANISED F.56

KEY ■

- Workstations are supplied not assembled
- Workstations must be fixed to the wall or floor
- All indicated loads are net and refer to evenly distributed weights



LENGTH = 1552 / 2052 mm DEPTH = 722 mm

WORKSTATIONS SERIES COMFORT

WORKSTATIONS COMFORT



WORKSTATION SERIES COMFORT

ORD. NO. DIMENSIONS mm

F LD 0001 05 56 1552x722x1817 h

Complete with: shelves, footrest, perforated panels, chair

Not included: electrical systems, lamps, tools, hooks and electrical tools

Standard colour:

■ ■ ■ 56

■ Worktop adjustable in height from 797 to 911 mm

WORKSTATION SERIES COMFORT

ORD. NO. DIMENSIONS mm

F LD 0001 06 56 2052x722x1817 h

Complete with: shelves, footrest, perforated panels, chair, cabinet with wheels

Not included: electrical systems, lamps, tools, hooks and electrical tools

Standard colour:

■ ■ ■ 56



■ Worktop adjustable in height from 797 to 911 mm

■ KEY

■ ■ ■ RAL 7000+RAL 7035+GALVANISED F.56



- Workstations are supplied not assembled
- Workstations must be fixed to the wall or floor
- All indicated loads are net and refer to evenly distributed weights

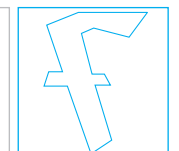
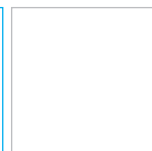
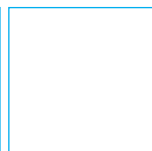

WORKSTATIONS SERIES COMFORT

LENGTH = 1552 mm DEPTH = 820 mm

WORKSTATIONS
COMFORT

■ Worktop adjustable in height from 797 to 911 mm



WORKSTATION SERIES COMFORT

ORD. NO.	DIMENSIONS mm
F LD K175 01 56	1552x820x1817 h
Complete with: 1 shelf 220 mm, 1 shelf 320 mm, 2 perforated panels, 1 worktop	
Standard colour:	
■ ■ ■ 56	



Configuration example



FOOTREST WITH RUBBER

ORD. NO. F BL 7795 01 99

Dim. mm 220x1440 (A=1470)

■ Worktop adjustable in height from 797 to 911 mm



WORKSTATION SERIES COMFORT

ORD. NO.	DIMENSIONS mm
F LD D125 01 56	1552x820x1285 h
Complete with: 1 shelf 320 mm, 2 perforated panels, 1 worktop	
Standard colour:	
■ ■ ■ 56	



Configuration example

RAL 7000+RAL 7035+GALVANISED F.56

KEY ■

- Workstations are supplied not assembled
- Workstations must be fixed to the wall or floor
- All indicated loads are net and refer to evenly distributed weights



WORKSTATIONS COMFORT



PAIR OF FRONT SUPPORTS
ORD. NO. F BL 9450 00 99
 Pair of supports for fixing to front raceway
 Standard colour: ■ GALVANISED F.99



MULTIPURPOSE SUPPORT
ORD. NO. F BL 7461 00 08
 Dim. 70x60x70 mm
 Standard colour: ■ RAL 7035 F.08



WALDMANN SWIVEL LAMP WITH THREE JOINTS 1x36 W IP 20

ORD. NO.	DIMENSIONS mm
F BL 9980 00 08	910x90x105 h
Complete with multipurpose support	
Standard colour: ■ RAL 7035 F.08	



POLYURETHANE CHAIR

ORD. NO.
F QZ 2211 00 07
Adjustable in height using a gas pump
Height: from 495 to 670 mm
Standard colour: ■ RAL 9011 F.07

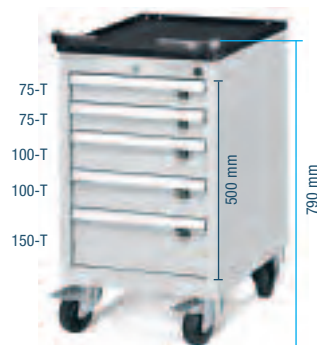

ORD. NO.	DRAWERS
F DA D550 04 08	5
Cabinet with 5 full extension drawers	
Standard rubber wheels Ø 100 mm	
Cabinet load capacity: 170 kg	
Dim. mm 428x675x790 h Central lock	
Colours available: ■ 01 ■ 02 ■ 04 ■ 08	

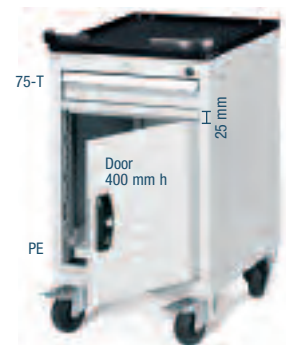

ORD. NO.	DRAWERS
F DA D550 06 08	1
Cabinet with 1 full extension drawer,	
1 retractable shelf 100%. Standard rubber wheels	
Ø 100 mm. Cabinet load capacity: 170 kg	
Dim. mm 428x675x790 h Central lock	
Colours available: ■ 01 ■ 02 ■ 04 ■ 08	



ORD. NO.	DRAWERS
F DB B550 02 08	4
Cabinet with 4 full extension drawers	
Standard rubber wheels Ø 125 mm	
Cabinet load capacity: 235 kg	
Dim. mm 564x675x820 h Central lock	
Colours available: ■ 01 ■ 02 ■ 04 ■ 08	



ORD. NO.	DRAWERS
F DB B550 03 08	5
Cabinet with 5 full extension drawers	
Standard rubber wheels Ø 125 mm	
Cabinet load capacity: 235 kg	
Dim. mm 564x675x820 h Central lock	
Colours available: ■ 01 ■ 02 ■ 04 ■ 08	



RACEWAYS WITH WIRED SOCKETS + MAGNETOTHERMIC SWITCH

ORD. NO.	type and number of wired sockets:					
	D	F	GB	I	CH	IL
F BL 9260 10 08	9	-	-	-	-	-
F BL 9260 20 08	-	9	-	-	-	-
F BL 9260 25 08	4	5	-	-	-	-
F BL 9260 30 08	-	-	6	-	-	-
F BL 9260 35 08	4	-	3	-	-	-
F BL 9260 40 08	-	-	-	9	-	-
F BL 9260 45 08	4	-	-	5	-	-
F BL 9260 50 08	-	-	-	-	9	-
F BL 9260 55 08	4	-	-	-	5	-
F BL 9260 70 08	-	-	-	-	-	9
F BL 9260 75 08	4	-	-	-	-	5

Dimensions mm 1420x60x85 h Standard colour: ■ RAL 7035 F.08

■ KEY

- RAL 7000 F.01
- RAL 6011 F.02
- RAL 5012 F.04
- RAL 7035 F.08



- PE = full extension retractable shelf (100%)
- T = full extension (100%)



WORKSTATIONS SERIES COMFORT

LENGTH = 2052 mm DEPTH = 820 mm

WORKSTATIONS
COMFORT

■ Worktop adjustable
in height from 797
to 911 mm



WORKSTATION SERIES COMFORT

ORD. NO.	DIMENSIONS mm
F LD V173 01 56	2052x820x1817 h
Complete with: 2 shelves 220 mm, 2 shelves 320 mm, 4 perforated panels, 1 worktop	
Standard colour:	
■ ■ ■ 56	



Configuration example



FOOTREST WITH RUBBER

ORD. NO. F BL 7750 01 99

Dim. mm 220x955 (A=985)

■ Worktop adjustable in
height from 797
to 911 mm

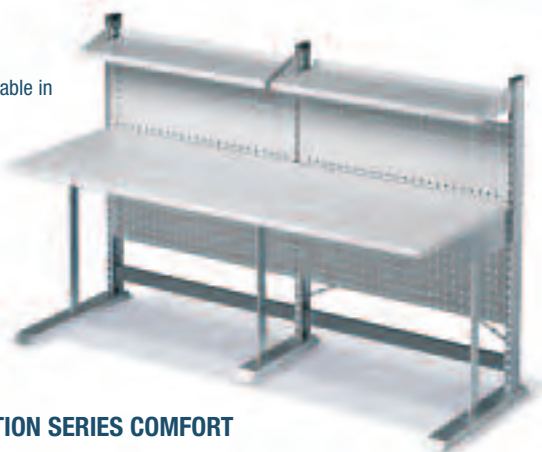

WORKSTATION SERIES COMFORT

ORD. NO.	DIMENSIONS mm
F LD R123 01 56	2052x820x1285 h
Complete with: 2 shelves 320 mm, 4 perforated panels, 1 worktop	
Standard colour:	
■ ■ ■ 56	



Configuration example

■ ■ ■ RAL 7000+RAL 7035+GALVANISED F.56

KEY ■

- Workstations are supplied not assembled
- Workstations must be fixed to the wall or floor
- All indicated loads are net and refer to evenly distributed weights



WORKSTATIONS COMFORT



PAIR OF FRONT SUPPORTS
ORD. NO. F BL 9450 00 99
 Pair of supports for fixing to front raceway
 Standard colour: ■ GALVANISED F.99



MULTIPURPOSE SUPPORT
ORD. NO. F BL 7461 00 08
 Dim. 70x60x70 mm
 Standard colour: ■ RAL 7035 F.08

RACEWAYS WITH WIRED SOCKETS

ORD. NO.	type and number of wired sockets:					
	D	F	GB	I	CH	IL
F BL 9310 10 08	9	-	-	-	-	-
F BL 9310 20 08	-	9	-	-	-	-
F BL 9310 25 08	4	5	-	-	-	-
F BL 9310 30 08	-	-	6	-	-	-
F BL 9310 35 08	4	-	3	-	-	-
F BL 9310 40 08	-	-	-	9	-	-
F BL 9310 45 08	4	-	-	5	-	-
F BL 9310 50 08	-	-	-	-	9	-
F BL 9310 55 08	4	-	-	-	5	-
F BL 9310 70 08	-	-	-	-	-	9
F BL 9310 75 08	4	-	-	-	-	5

Dimensions: mm 1920x60x85 h Standard colour: ■ RAL 7035 F.08



WALDMANN SWIVEL LAMP WITH THREE JOINTS 1x36 W IP 20

ORD. NO.	DIMENSIONS mm
F BL 9980 00 08	910x90x105 h
Complete with multipurpose support	
Standard colour: ■ RAL 7035 F.08	



ORD. NO.	DRAWERS
F DA D550 04 08	5
Cabinet with 5 full extension drawers	
Standard rubber wheels Ø 100 mm	
Cabinet load capacity: 170 kg	
Dim. mm 428x675x790 h	Central lock
Colours available: ■ 01 ■ 02 ■ 04 ■ 08	

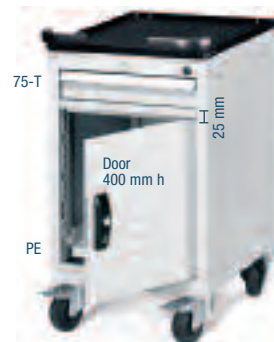

ORD. NO.	DRAWERS
F DA D550 06 08	1
Cabinet with 1 full extension drawer,	
1 retractable shelf 100%. Standard rubber wheels	
Ø 100 mm. Cabinet load capacity: 170 kg	
Dim. mm 428x675x790 h	Central lock
Colours available: ■ 01 ■ 02 ■ 04 ■ 08	



POLYURETHANE CHAIR

ORD. NO.
F QZ 2211 00 07
Adjustable in height using a gas pump
Height: from 495 to 670 mm
Standard colour: ■ RAL 9011 F.07

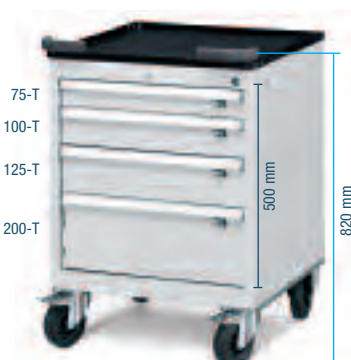

ORD. NO.	DRAWERS
F DB B550 02 08	4
Cabinet with 4 full extension drawers	
Standard rubber wheels Ø 125 mm	
Cabinet load capacity: 235 kg	
Dim. mm 564x675x820 h	Central lock
Colours available: ■ 01 ■ 02 ■ 04 ■ 08	



ORD. NO.	DRAWERS
F DB B550 03 08	5
Cabinet with 5 full extension drawers	
Standard rubber wheels Ø 125 mm	
Cabinet load capacity: 235 kg	
Dim. mm 564x675x820 h	Central lock
Colours available: ■ 01 ■ 02 ■ 04 ■ 08	

■ KEY

■ RAL 7000 F.01 ■ RAL 6011 F.02 ■ RAL 5012 F.04 ■ RAL 7035 F.08



- PE = full extension retractable shelf (100%)
- T = full extension (100%)



WORKSTATIONS SERIES COMFORT

WORKSTATIONS COMFORT

DOUBLE SIDED BASE FRAME

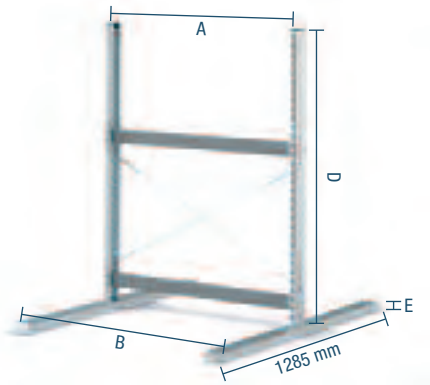

ORD. NO.	A mm	B mm	D mm	E mm
F LD A123 00 52	985	1067	1240	40
F LD A125 00 52	1470	1552	1240	40
Load capacity of 1 upright: 150 kg (75 kg per side)				
Standard colour: ■■ 52				

ADDITIONAL DOUBLE SIDED FRAME WITH CROSS BRACING

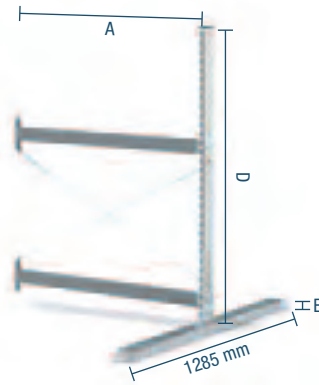

ORD. NO.	A mm	B mm	D mm	E mm
F LD B123 00 52	985	-	1240	40
F LD B125 00 52	1470	-	1240	40
Load capacity of 1 upright: 150 kg (75 kg per side)				
Standard colour: ■■ 52				

ADDITIONAL DOUBLE SIDED FRAME WITHOUT CROSS BRACING

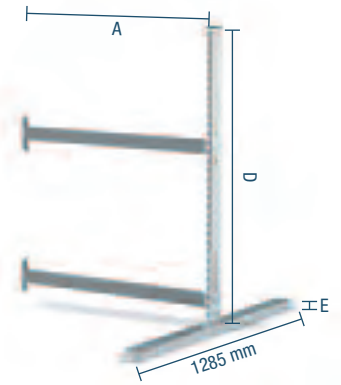

ORD. NO.	A mm	B mm	D mm	E mm
F LD C123 00 52	985	-	1240	40
F LD C125 00 52	1470	-	1240	40
Load capacity of 1 upright: 150 kg (75 kg per side)				
Standard colour: ■■ 52				

SINGLE SIDED BASE FRAME

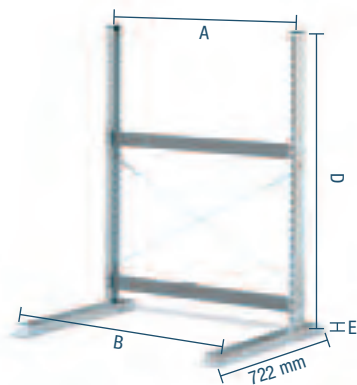

ORD. NO.	A mm	B mm	D mm	E mm
F LD D123 00 52	985	1065	1240	40
F LD D125 00 52	1470	1550	1240	40
Load capacity of 1 upright: 150 kg (75 kg per side)				
Standard colour: ■■ 52				

ADDITIONAL SINGLE SIDED FRAME WITH CROSS BRACING

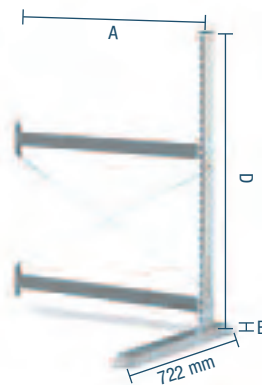

ORD. NO.	A mm	B mm	D mm	E mm
F LD E123 00 52	985	-	1240	40
F LD E125 00 52	1470	-	1240	40
Load capacity of 1 upright: 150 kg (75 kg per side)				
Standard colour: ■■ 52				

ADDITIONAL SINGLE SIDED FRAME WITHOUT CROSS BRACING

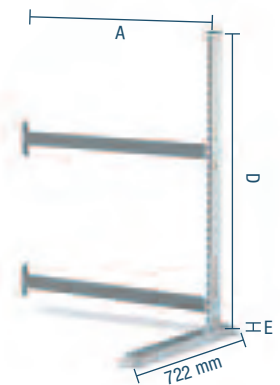

ORD. NO.	A mm	B mm	D mm	E mm
F LD F123 00 52	985	-	1240	40
F LD F125 00 52	1470	-	1240	40
Load capacity of 1 upright: 150 kg (75 kg per side)				
Standard colour: ■■ 52				

■ ■ RAL 7000+GALVANISED F.52

KEY ■

- Workstations are supplied not assembled
- Workstations must be fixed to the wall or floor
- All indicated loads are net and refer to evenly distributed weights



DOUBLE SIDED BASE FRAME

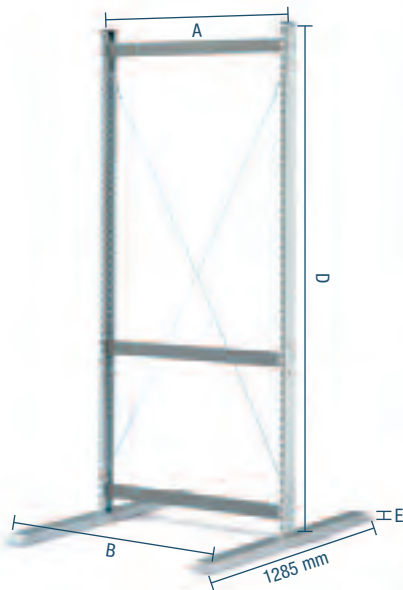

ORD. NO.	A mm	B mm	D mm	E mm
F LD G173 00 52	985	1065	1772	40
F LD G175 00 52	1470	1550	1772	40
F LD G213 00 52	985	1065	2152	40
F LD G215 00 52	1470	1550	2152	40
Load capacity of 1 upright: 150 kg (75 kg per side)				
Standard colour: ■■ 52				

ADDITIONAL DOUBLE SIDED FRAME WITH CROSS BRACING

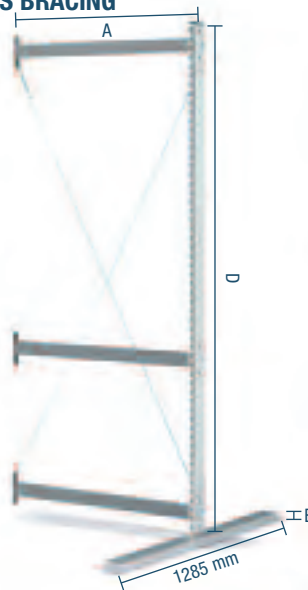

ORD. NO.	A mm	B mm	D mm	E mm
F LD H173 00 52	985	-	1772	40
F LD H175 00 52	1470	-	1772	40
F LD H213 00 52	985	-	2152	40
F LD H215 00 52	1470	-	2152	40
Load capacity of 1 upright: 150 kg (75 kg per side)				
Standard colour: ■■ 52				

ADDITIONAL DOUBLE SIDED FRAME WITHOUT CROSS BRACING

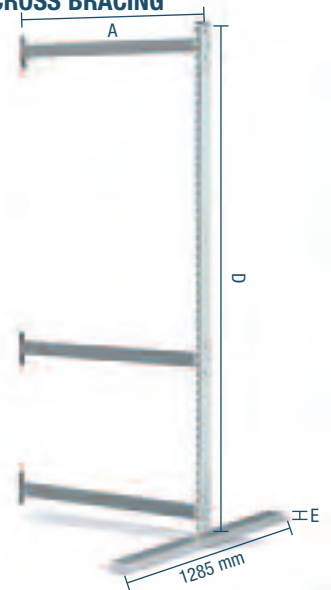

ORD. NO.	A mm	B mm	D mm	E mm
F LD J173 00 52	985	-	1772	40
F LD J175 00 52	1470	-	1772	40
F LD J213 00 52	985	-	2152	40
F LD J215 00 52	1470	-	2152	40
Load capacity of 1 upright: 150 kg (75 kg per side)				
Standard colour: ■■ 52				

SINGLE SIDED BASE FRAME



ORD. NO.	A mm	B mm	D mm	E mm
F LD K173 00 52	985	1065	1772	40
F LD K175 00 52	1470	1550	1772	40
F LD K213 00 52	985	1065	2152	40
F LD K215 00 52	1470	1550	2152	40
Load capacity of 1 upright: 150 kg (75 kg per side)				
Standard colour: ■■ 52				

ADDITIONAL SINGLE SIDED FRAME WITH CROSS BRACING

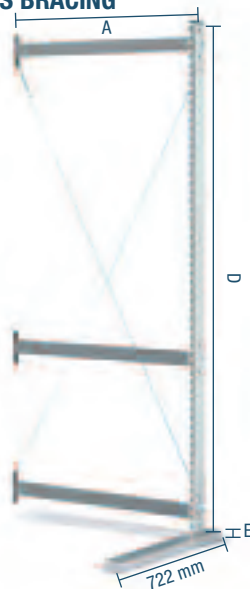

ORD. NO.	A mm	B mm	D mm	E mm
F LD L173 00 52	985	-	1772	40
F LD L175 00 52	1470	-	1772	40
F LD L213 00 52	985	-	2152	40
F LD L215 00 52	1470	-	2152	40
Load capacity of 1 upright: 150 kg (75 kg per side)				
Standard colour: ■■ 52				

ADDITIONAL SINGLE SIDED FRAME WITHOUT CROSS BRACING



ORD. NO.	A mm	B mm	D mm	E mm
F LD M173 00 52	985	-	1772	40
F LD M175 00 52	1470	-	1772	40
F LD M213 00 52	985	-	2152	40
F LD M215 00 52	1470	-	2152	40
Load capacity of 1 upright: 150 kg (75 kg per side)				
Standard colour: ■■ 52				

■ KEY

■■ RAL 7000+GALVANISED F.52



- Workstations are supplied not assembled
- Workstations must be fixed to the wall or floor
- All indicated loads are net and refer to evenly distributed weights

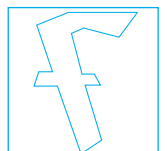
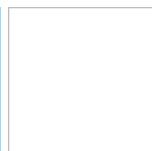
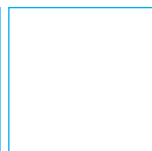

WORKSTATIONS SERIES COMFORT

WORKSTATIONS COMFORT

DOUBLE SIDED BASE FRAME

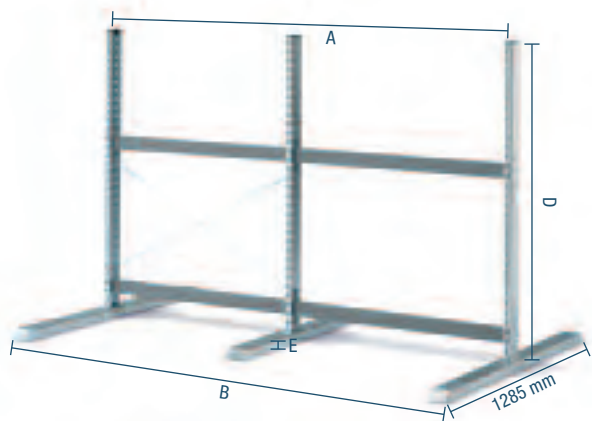

ADDITIONAL DOUBLE SIDED FRAME

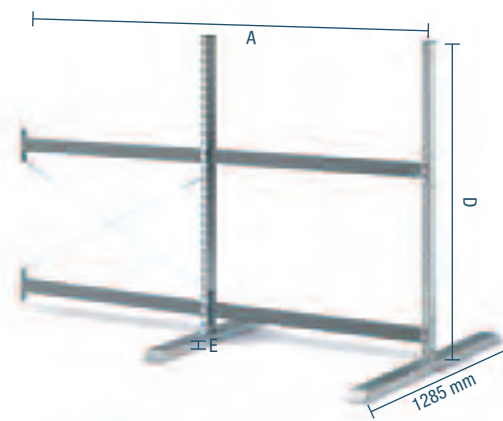

ORD. NO.	A mm	B mm	D mm	E mm
F LD N123 00 52	1970	2052	1240	40
Load capacity of 1 upright: 150 kg (75 kg per side)				
Standard colour: ■■ 52				

ORD. NO.	A mm	B mm	D mm	E mm
F LD P123 00 52	1970	-	1240	40
Load capacity of 1 upright: 150 kg (75 kg per side)				
Standard colour: ■■ 52				

SINGLE SIDED BASE FRAME

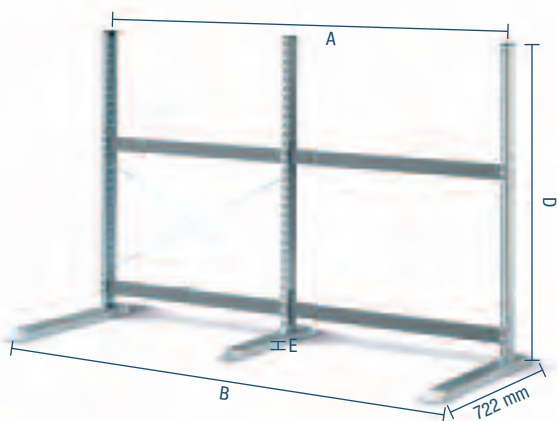

ADDITIONAL SINGLE SIDED FRAME

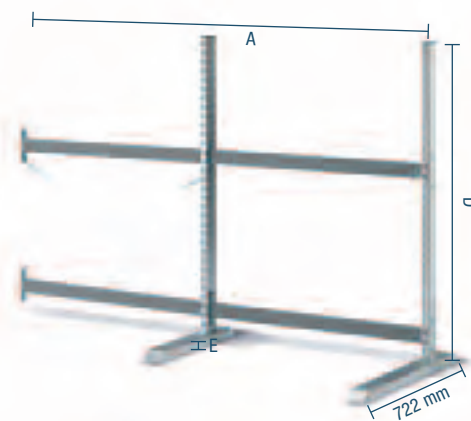

ORD. NO.	A mm	B mm	D mm	E mm
F LD R123 00 52	1970	2052	1240	40
Load capacity of 1 upright: 150 kg (75 kg per side)				
Standard colour: ■■ 52				

ORD. NO.	A mm	B mm	D mm	E mm
F LD S123 00 52	1970	-	1240	40
Load capacity of 1 upright: 150 kg (75 kg per side)				
Standard colour: ■■ 52				

■ ■ RAL 7000+GALVANISED F.52



KEY ■

- Workstations are supplied not assembled
- Workstations must be fixed to the wall or floor
- All indicated loads are net and refer to evenly distributed weights



DOUBLE SIDED BASE FRAME

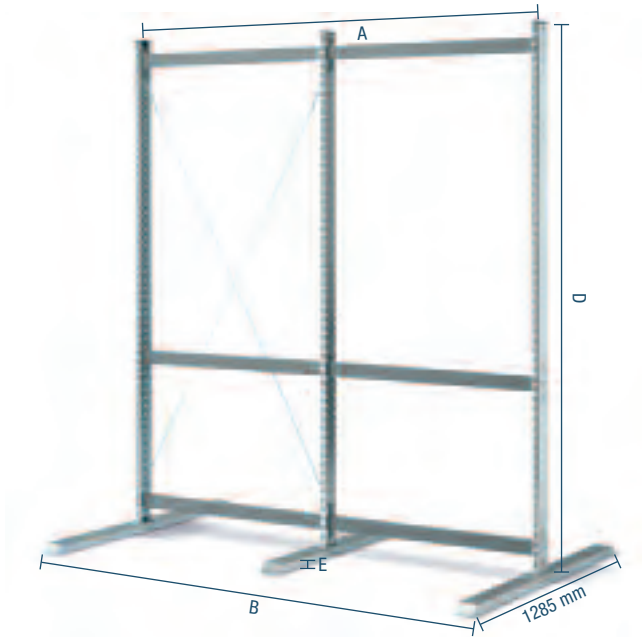

ORD. NO.	A mm	B mm	D mm	E mm
F LD T173 00 52	1970	2052	1772	40
F LD T213 00 52	1970	2052	2152	40

Load capacity of 1 upright: 150 kg (75 kg per side)
Standard colour: ■■ 52

ADDITIONAL DOUBLE SIDED FRAME



ORD. NO.	A mm	B mm	D mm	E mm
F LD U173 00 52	1970	-	1772	40
F LD U213 00 52	1970	-	2152	40

Load capacity of 1 upright: 150 kg (75 kg per side)
Standard colour: ■■ 52

SINGLE SIDED BASE FRAME

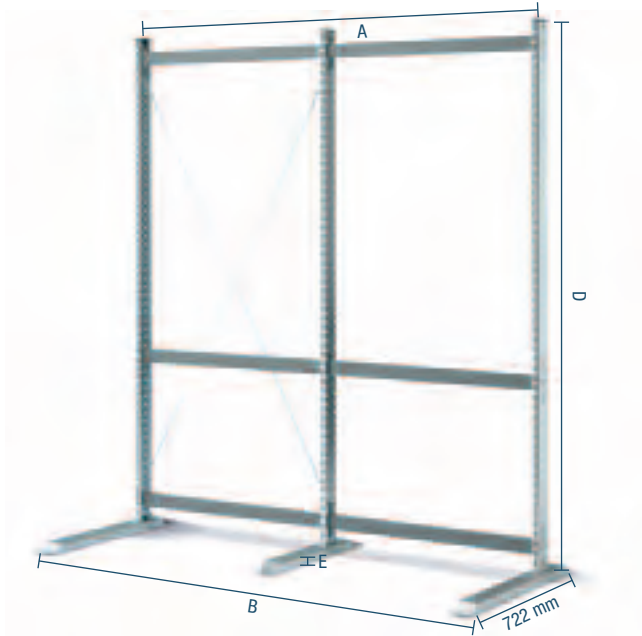

ORD. NO.	A mm	B mm	D mm	E mm
F LD V173 00 52	1970	2052	1772	40
F LD V213 00 52	1970	2052	2152	40

Load capacity of 1 upright: 150 kg (75 kg per side)
Standard colour: ■■ 52

ADDITIONAL SINGLE SIDED FRAME

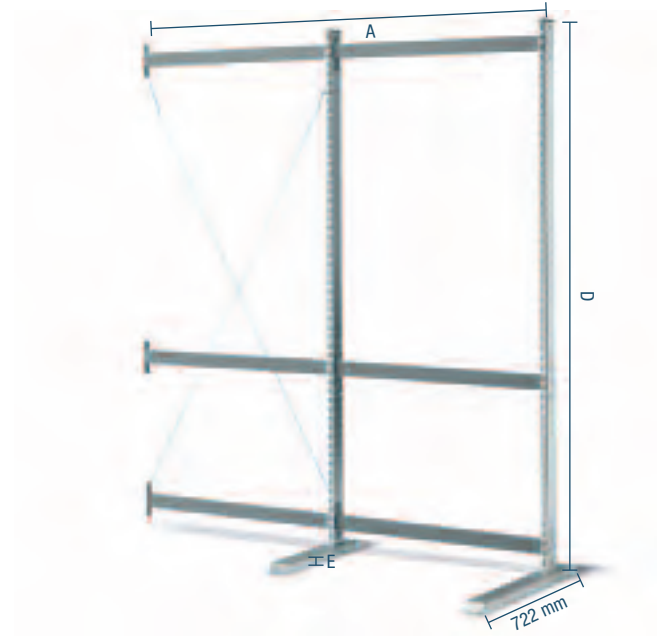

ORD. NO.	A mm	B mm	D mm	E mm
F LD X173 00 52	1970	-	1772	40
F LD X213 00 52	1970	-	2152	40

Load capacity of 1 upright: 150 kg (75 kg per side)
Standard colour: ■■ 52

■ KEY



- Workstations are supplied not assembled
- Workstations must be fixed to the wall or floor
- All indicated loads are net and refer to evenly distributed weights

■■■■ RAL 7000+GALVANISED F... ..52



WORKSTATIONS SERIES COMFORT

WORKTOP ADJUSTABLE IN HEIGHT FROM 797 mm TO 911 mm

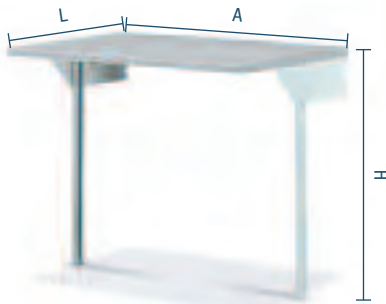

ORD. NO.	A mm	H mm	L mm
F LD 0960 A1 99	985	797 / 911	600
F LD 1460 A1 99	1470	797 / 911	600
F LD 0970 A1 99	985	797 / 911	700
F LD 1470 A1 99	1470	797 / 911	700

Height adjustment - distance 38 mm. Load cap. 50 kg
Standard colour: ■ 99 GALVANISED

WORKTOP ADJUSTABLE IN HEIGHT FROM 797 mm TO 911 mm

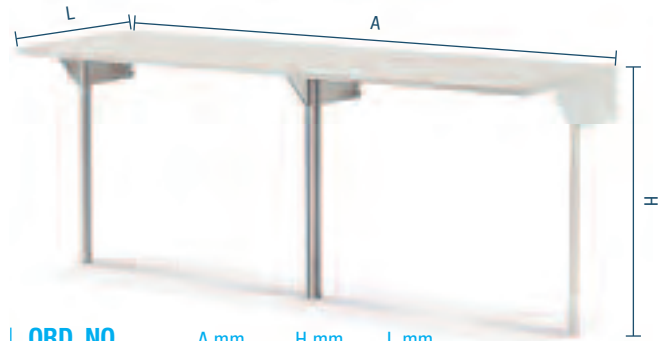

ORD. NO.	A mm	H mm	L mm
F LD 1960 A1 99	1970	797 / 911	600
F LD 1970 A1 99	1970	797 / 911	700

Height adjustment - distance 38 mm
Load capacity 100 kg
Standard colour: ■ 99 GALVANISED

WORKTOP ADJUSTABLE IN HEIGHT FROM 949 mm TO 1063 mm

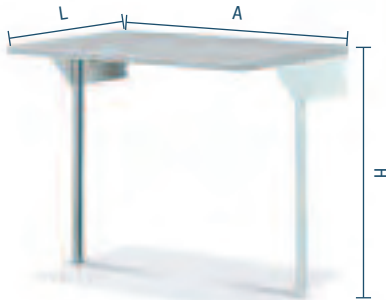

ORD. NO.	A mm	H mm	L mm
F LD 0960 A2 99	985	949 / 1063	600
F LD 1460 A2 99	1470	949 / 1063	600
F LD 0970 A2 99	985	949 / 1063	700
F LD 1470 A2 99	1470	949 / 1063	700

Height adjustment - distance 38 mm. Load cap. 50 kg
Standard colour: ■ 99 GALVANISED

WORKTOP ADJUSTABLE IN HEIGHT FROM 949 mm TO 1063 mm

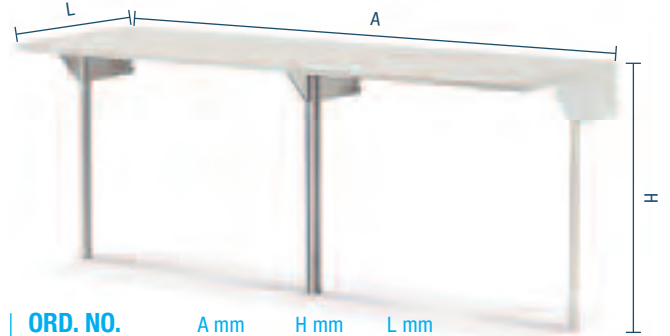

ORD. NO.	A mm	H mm	L mm
F LD 1960 A2 99	1970	949 / 1063	600
F LD 1970 A2 99	1970	949 / 1063	700

Height adjustment - distance 38 mm
Load capacity 100 kg.
Standard colour: ■ 99 GALVANISED

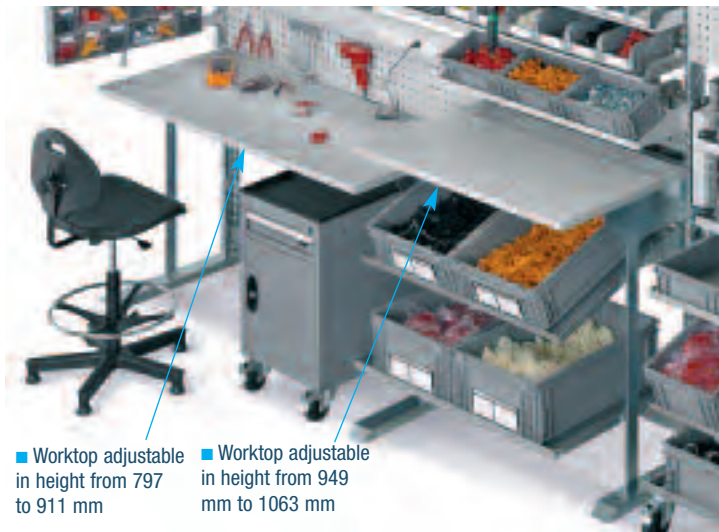

- Worktop adjustable in height from 797 to 911 mm
- Worktop adjustable in height from 949 mm to 1063 mm



FOOTREST WITH RUBBER FOR COMFORT SERIES WORKSTATIONS

ORD. NO.	DIMENSIONS mm
F BL 7750 01 99	220x955 (A=985)
F BL 7795 01 99	220x1440 (A=1470)

Standard colour: ■ 99 GALVANISED

GALVANISED
F... 99



KEY ■

- Workstations are supplied not assembled
- Workstations must be fixed to the wall or floor
- All indicated loads are net and refer to evenly distributed weights



1 DUAL SLOT UPRIGHT

ORD. NO.	HEIGHT mm
F BL 7540 02 99	1240
F BL 7547 02 99	1772
F BL 7555 02 99	2152

Standard colour: ■ 01 ■ 02 ■ 04 ■ 08 ■ 99 GALVANISED

2 BASE BAR

ORD. NO.	LENGTH mm
F BL 4505 00 01	1011 (A=985)
F BL 4510 00 01	1496 (A=1470)

Standard colour: ■ 01

3 ADDITIONAL BAR

ORD. NO.	LENGTH mm
F BL 4506 00 01	983 (A=985)
F BL 4511 00 01	1468 (A=1470)

Standard colour: ■ 01

4 PAIR OF CAPS

ORD. NO.
F BL 4420 00 07

Standard colour: ■ 07

5 CROSS BRACING

ORD. NO.	MODULE mm
F BL 4715 00 99	A=985 / H=1240
F BL 4720 00 99	A=985 / H=1772
F BL 4725 00 99	A=985 / H=2152
F BL 4730 00 99	A=1470 / H=1240
F BL 4735 00 99	A=1470 / H=1772
F BL 4740 00 99	A=1470 / H=2152

Standard colour: ■ 99 GALVANISED

6 DOUBLE SIDED SIDE FOOT

ORD. NO.	LENGTH mm
F BL 4520 00 99	1285

Standard colour: ■ 99 GALVANISED

7 DOUBLE SIDED CENTRAL FOOT

ORD. NO.	LENGTH mm
F BL 4525 00 99	925

Standard colour: ■ 99 GALVANISED
Only for use with the 1970 mm long worktop

8 SINGLE SIDED SIDE FOOT

ORD. NO.	LENGTH mm
F BL 4530 00 99	722

Standard colour: ■ 99 GALVANISED

9 SINGLE SIDED CENTRAL FOOT

ORD. NO.	LENGTH mm
F BL 4535 00 99	542

Standard colour: ■ 99 GALVANISED
Only for use with the 1970 mm long worktop

10 LEFT SUPPORT BRACKET

ORD. NO.
F BL 4545 00 99

Dim. 39x400x143 mm h
Standard colour: ■ 99 GALVANISED

11 RIGHT SUPPORT BRACKET

ORD. NO.
F BL 4540 00 99

Dim. 39x400x143 mm h
Standard colour: ■ 99 GALVANISED

12 UPRIGHT

ORD. NO.	HEIGHT mm
F BL 4550 00 99	726
F BL 4555 00 99	878

Standard colour: ■ 99 GALVANISED

13 WORKTOP COVERED WITH GREY LAMINATE

ORD. NO.	DIMENSIONS mm
F BS 0960 00 08	985x600x30 h
F BS 0970 00 08	985x700x30 h
F BS 1460 00 08	1470x600x30 h
F BS 1470 00 08	1470x700x30 h
F BS 1960 00 08	1970x600x30 h
F BS 1970 00 08	1970x700x30 h

Hardboard worktop covered with grey laminate

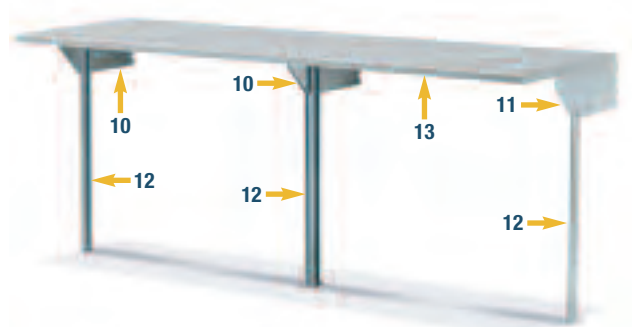
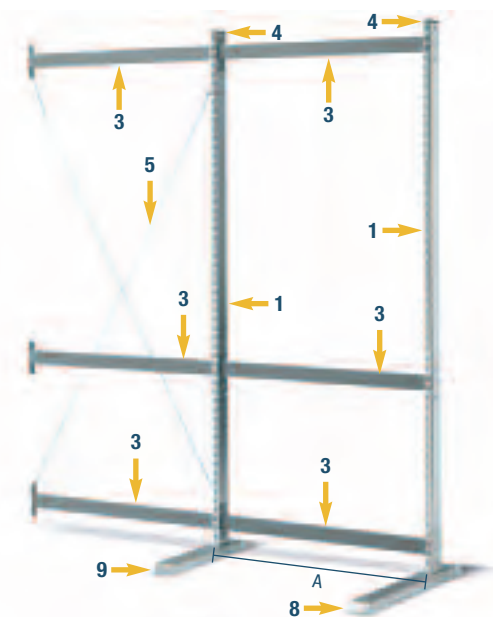
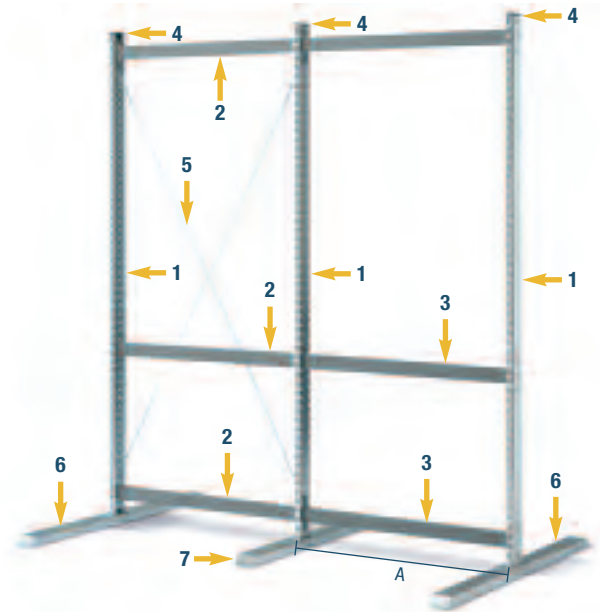

■ KEY

■ RAL 7000 F.....01	■ RAL 6011 F.....02	■ RAL 5012 F.....04	■ RAL 7035 F.....08	■ GALVANISED F.....99
---------------------	---------------------	---------------------	---------------------	-----------------------



- Workstations are supplied not assembled
- Workstations must be fixed to the wall or floor

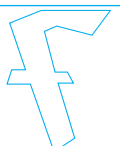



ORD. NO. F LE 0001 01 55
RAL 7035 + GALVANISED

FLOOR FIXING SET

■ 99 GALVANISED



■ 2 dowels suitable for uncracked concrete class B25/RBK250/MPA 25 N/mm²
Dowel diameter: Ø 6x85 mm

ORD. NO. F BL 8999 00 99

WALL FIXING SET

■ 99 GALVANISED



Wall fixing bracket for dual slot uprights
Articulated, complete with bolts and screws
Dowels not included

ORD. NO. F BL 8998 00 99

WORKSTATION SERIES DYNAMIC

ORD. NO.

DIMENSIONS mm

F LE 0001 01 55

3522x1500x2220 h

Complete with: shelves, containers, boxes, perforated panels, supports with aluminium tracks, drawer cabinets, chairs

Not included: pneumatic systems, electrical systems, lamps, tools and electrical tools

Standard colour:

■ RAL 7035+GALVANISED F.55

RAL 7035+GALVANISED F.55

KEY ■

- Workstations are supplied not assembled
- Workstations must be fixed to the wall or floor
- All indicated loads are net and refer to evenly distributed weights



WORKSTATIONS SERIES DYNAMIC

WORKSTATIONS DYNAMIC

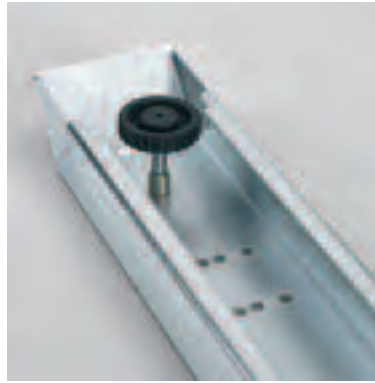

The base of the **DYNAMIC** series workstations is fitted with feet that are adjustable in height from **0** to **10** mm.

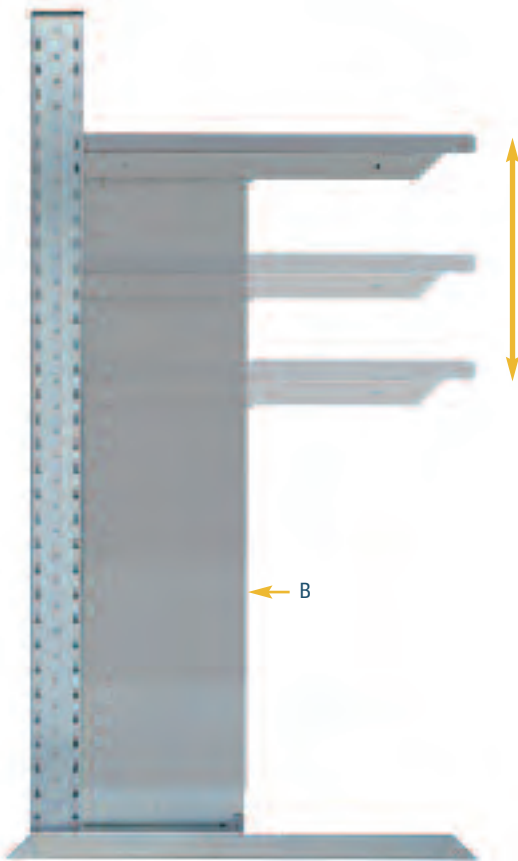

The height of the worktops of the **DYNAMIC** series workstations can be set in the assembly phase thanks to the extensible support (ref. B) from 720 mm to 1138 mm.



In the **DYNAMIC** series workstations there are two grooves on the frame under the worktop so the **FLEXA** series cabinets can be installed and can slide to the right or to the left, using the special supports.

■ KEY



- Workstations are supplied not assembled
- Workstations must be fixed to the wall or floor
- All indicated loads are net and refer to evenly distributed weights

RAL 7035+GALVANISED F.....55

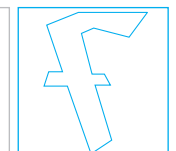
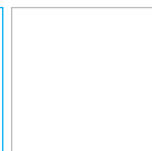
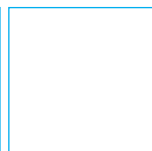

WORKSTATIONS SERIES DYNAMIC

LENGTH = 3522 mm DEPTH = 1500 mm

WORKSTATIONS DYNAMIC



■ ■ 55

RAL 7035+GALVANISED F.55

KEY ■

- Workstations are supplied not assembled
- Workstations must be fixed to the wall or floor
- All indicated loads are net and refer to evenly distributed weights



LENGTH = 3522 mm DEPTH = 1500 mm

WORKSTATIONS SERIES DYNAMIC

WORKSTATIONS DYNAMIC



WORKSTATION SERIES DYNAMIC

ORD. NO.	DIMENSIONS mm
F LE 0001 01 55	3522x1500x2220 h
Complete with: shelves, containers, boxes, perforated panels, supports with aluminium tracks, drawer cabinets, chairs	
Not included: pneumatic systems, electrical systems, lamps, tools and electrical tools	
Standard colour:	
■ ■ 55	



■ KEY



- Workstations are supplied not assembled
- Workstations must be fixed to the wall or floor
- All indicated loads are net and refer to evenly distributed weights

■ ■ RAL 7035+GALVANISED F.....55

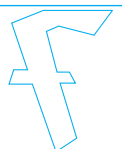

WORKSTATIONS SERIES DYNAMIC

LENGTH = 1067 mm DEPTH = 1500 mm

WORKSTATIONS DYNAMIC



WORKSTATION SERIES DYNAMIC

ORD. NO.

DIMENSIONS MM

F LE 0001 02 55 1067x1500x2220 h

Complete with: containers, boxes, supports with aluminium tracks, swivel arms with two joints, chairs, trolleys series SMART

Not included: pneumatic systems, electrical systems, lamps, tools and electrical tools

Standard colour:

■ ■ 55

RAL 7035+GALVANISED F.55

KEY ■

- Workstations are supplied not assembled
- Workstations must be fixed to the wall or floor
- All indicated loads are net and refer to evenly distributed weights



LENGTH = 2052 mm DEPTH = 722 mm

WORKSTATIONS SERIES DYNAMIC

WORKSTATIONS DYNAMIC



WORKSTATION SERIES DYNAMIC

ORD. NO. DIMENSIONS mm

F LE 0001 03 55 2052x722x2220 h

Complete with: shelves, containers, boxes, perforated panels, supports with aluminium tracks, drawer cabinet, chair

Not included: pneumatic systems, electrical systems, lamps, hooks, tools and electrical tools

Standard colour:

■ 55

■ KEY

■ RAL 7035+GALVANISED F.....55



- Workstations are supplied not assembled
- Workstations must be fixed to the wall or floor
- All indicated loads are net and refer to evenly distributed weights

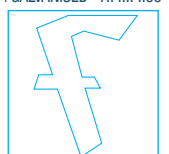
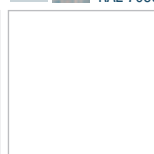
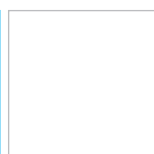

WORKSTATIONS SERIES DYNAMIC

LENGTH = 1735 mm DEPTH = 722 mm

WORKSTATIONS DYNAMIC



■ ■ 55

RAL 7035+GALVANISED F.55

KEY ■

- Workstations are supplied not assembled
- Workstations must be fixed to the wall or floor
- All indicated loads are net and refer to evenly distributed weights



LENGTH = 1735 mm DEPTH = 722 mm

WORKSTATIONS SERIES DYNAMIC

WORKSTATIONS DYNAMIC



WORKSTATION SERIES DYNAMIC

ORD. NO. DIMENSIONS mm

F LE 0001 04 55 1735x722x2220 h

Complete with: drawer cabinet, computer holding frame, swivel arms with two joints, chair

Not included: electrical systems, lamps, hooks, tools and electrical tools

Standard colour:

■ ■ 55



■ KEY



- Workstations are supplied not assembled
- Workstations must be fixed to the wall or floor
- All indicated loads are net and refer to evenly distributed weights

■ ■ RAL 7035+GALVANISED F.....55



WORKSTATIONS SERIES DYNAMIC

LENGTH = 1067 mm DEPTH = 1500 mm

WORKSTATIONS DYNAMIC + COMFORT

WORKSTATION SERIES DYNAMIC + COMFORT

ORD. NO. DIMENSIONS mm

F LE 0001 05 55 1067x1500x2220 h

Complete with: shelves, footrest, containers, boxes, perforated panels, supports with aluminium tracks, drawer cabinet

Not included: pneumatic systems, electrical systems, lamps, tools and electrical tools

Standard colour:

■ ■ 55

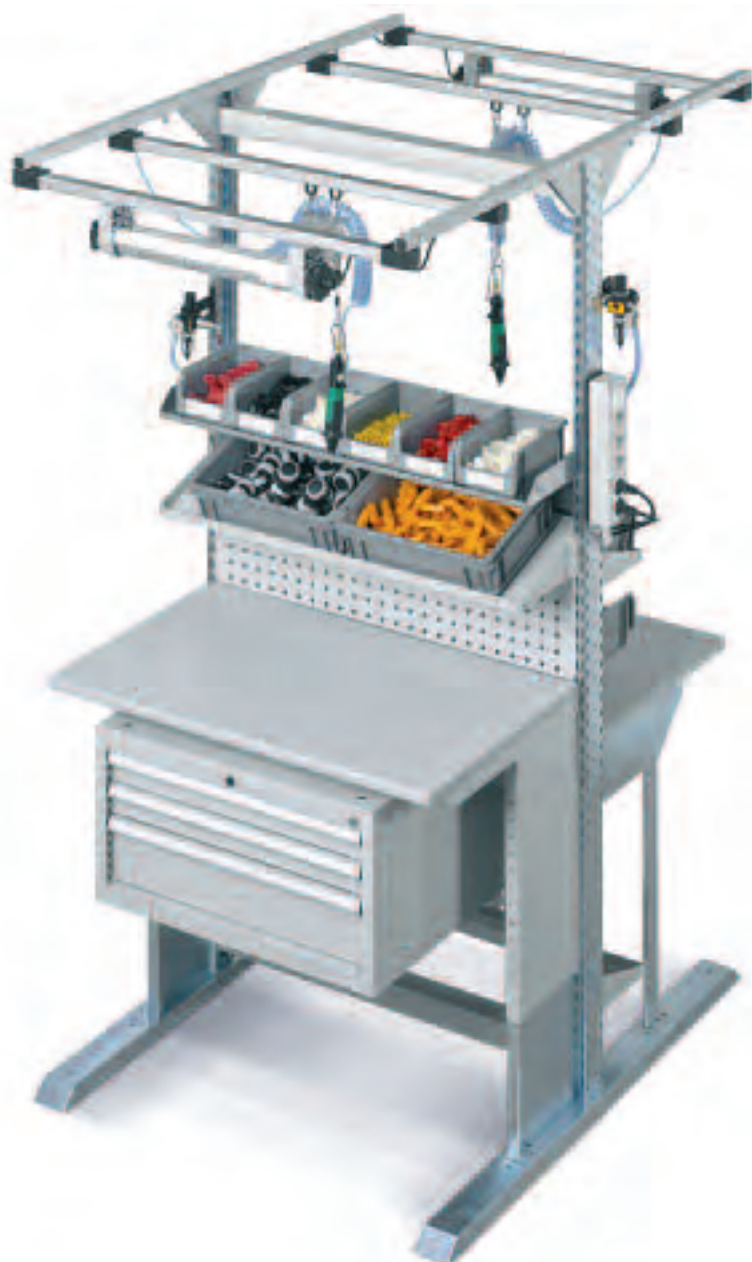

RAL 7035+GALVANISED F.55

KEY ■

- Workstations are supplied not assembled
- Workstations must be fixed to the wall or floor
- All indicated loads are net and refer to evenly distributed weights



LENGTH = 2052 mm DEPTH = 722 mm

WORKSTATIONS SERIES DYNAMIC

WORKSTATIONS DYNAMIC + COMFORT

WORKSTATION SERIES DYNAMIC + COMFORT

ORD. NO.	DIMENSIONS mm
----------	---------------

F LE 0001 06 55	2052x722x2220 h
-----------------	-----------------

Complete with: shelves, containers, boxes, perforated panels, supports with aluminium tracks, drawer cabinet

Not included: pneumatic systems, electrical systems, lamp, tools and electrical tools

Standard colour:

■ ■ 55



■ KEY



- Workstations are supplied not assembled
- Workstations must be fixed to the wall or floor
- All indicated loads are net and refer to evenly distributed weights



RAL 7035+GALVANISED F.....55

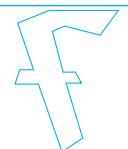

WORKSTATIONS SERIES DYNAMIC

LENGTH = 1552 mm DEPTH = 820 mm

WORKSTATIONS DYNAMIC



WORKSTATION SERIES DYNAMIC

ORD. NO. DIMENSIONS mm

F LE K175 01 55 1552x820x1817 h

Complete with: 1 shelf 220 mm, 1 shelf 320 mm, 3 perforated panels, 1 worktop

Standard colour:

■ ■ 55



Configuration example



PAIR OF SUPPORTS

ORD. NO. F BL 4600 00 08

Pair of supports for FLEXA series cabinets

For DYNAMIC series workstations only

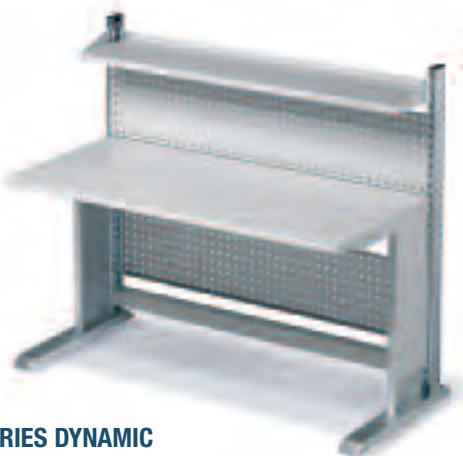

WORKSTATION SERIES DYNAMIC

ORD. NO. DIMENSIONS mm

F LE D125 01 55 1552x820x1285 h

Complete with: 1 shelf 320 mm, 2 perforated panels, 1 worktop

Standard colour:

■ ■ 55



Configuration example



RAL 7035+GALVANISED F.55

KEY ■

- Workstations are supplied not assembled
- Workstations must be fixed to the wall or floor
- All indicated loads are net and refer to evenly distributed weights



WORKSTATIONS DYNAMIC



PAIR OF FRONT SUPPORTS
ORD. NO. F BL 9450 00 99
 Pair of supports for fixing to front raceway
 Standard colour: ■ GALVANISED F.99



MULTIPURPOSE SUPPORT
ORD. NO. F BL 7461 00 08
 Dim. 70x60x70 mm
 Standard colour: ■ RAL 7035 F.08



WALDMANN SWIVEL LAMP WITH THREE JOINTS 1x36 W IP 20

ORD. NO. DIMENSIONS mm

F BL 9980 00 08 910x90x105 h

Complete with multipurpose support

Standard colour: ■ RAL 7035 F.08

RACEWAYS WITH WIRED SOCKETS + MAGNETOTHERMIC SWITCH

ORD. NO.	type and number of wired sockets:					
	D	F	GB	I	CH	IL
F BL 9260 10 08	9	-	-	-	-	-
F BL 9260 20 08	-	9	-	-	-	-
F BL 9260 25 08	4	5	-	-	-	-
F BL 9260 30 08	-	-	6	-	-	-
F BL 9260 35 08	4	-	3	-	-	-
F BL 9260 40 08	-	-	-	9	-	-
F BL 9260 45 08	4	-	-	5	-	-
F BL 9260 50 08	-	-	-	-	9	-
F BL 9260 55 08	4	-	-	-	5	-
F BL 9260 70 08	-	-	-	-	-	9
F BL 9260 75 08	4	-	-	-	-	5

Dimensions: mm 1420x60x85 h Standard colour: ■ RAL 7035 F.08

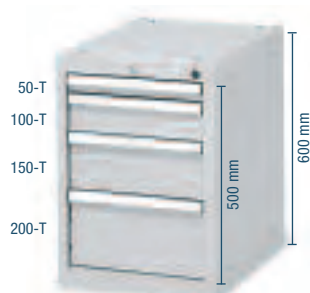

ORD. NO. DRAWERS

F DA 1050 52 08 4

Cabinet with 4 full extension drawers

Dim. mm 428x600x600 h Central lock

Colours available: ■ 01 ■ 02 ■ 04 ■ 08

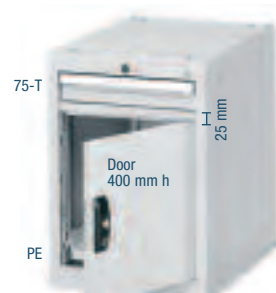

ORD. NO. DRAWERS

F DZ 1050 54 08 1

Cabinet with 1 full extension drawer, 1 retractable shelf 100%

Dim. mm 428x600x600 h Side lock

Colours available: ■ 01 ■ 02 ■ 04 ■ 08



POLYURETHANE CHAIR

ORD. NO.

F QZ 2211 00 07

Adjustable in height using a gas pump

Height: from 495 to 670 mm

Standard colour: ■ RAL 9011 F.07

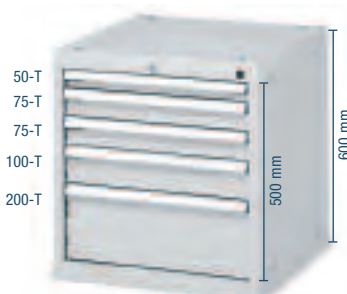

ORD. NO. DRAWERS

F DB 1050 53 08 5

Cabinet with 5 full extension drawers

Dim. mm 564x600x600 h

Central lock

Colours available: ■ 01 ■ 02 ■ 04 ■ 08



ORD. NO. DRAWERS

F DB 1050 55 08 3

Cabinet with 3 full extension drawers, 1 magnetothermic switch, 5 Schuko sockets, 1 pneumatic hose (fast coupling not included)

Dim. mm 564x600x600 h Central lock

Colours available: ■ 01 ■ 02 ■ 04 ■ 08

KEY

■ RAL 7000 F.01 ■ RAL 6011 F.02 ■ RAL 5012 F.04 ■ RAL 7035 F.08



- PE = full extension retractable shelf (100%)
- T = full extension (100%)
- All indicated loads are net and refer to evenly distributed weights



WORKSTATIONS SERIES DYNAMIC

LENGTH = 2052 mm DEPTH = 820 mm

WORKSTATIONS
DYNAMIC

WORKSTATION SERIES DYNAMIC

ORD. NO. DIMENSIONS mm

F LE V173 01 55 2052x820x1817 h

Complete with: 2 shelves 220 mm, 2 shelves 320 mm, 6 perforated panels, 1 worktop

Standard colour:

■ ■ 55



Configuration example



PAIR OF SUPPORTS

ORD. NO. F BL 4600 00 08

Pair of supports for FLEXA series cabinets

For DYNAMIC series workstations only



WORKSTATION SERIES DYNAMIC

ORD. NO. DIMENSIONS mm

F LE R123 01 55 2052x820x1285 h

Complete with: 2 shelves 320 mm, 4 perforated panels, 1 worktop

Standard colour:

■ ■ 55



Configuration example



RAL 7035+GALVANISED F.55



KEY ■

- Workstations are supplied not assembled
- Workstations must be fixed to the wall or floor
- All indicated loads are net and refer to evenly distributed weights





WORKSTATIONS DYNAMIC

PAIR OF FRONT SUPPORTS
ORD. NO. F BL 9450 00 99
 Pair of supports for fixing to front raceway
 Standard colour: ■ GALVANISED F.99

MULTIPURPOSE SUPPORT
ORD. NO. F BL 7461 00 08
 Dim. 70x60x70 mm
 Standard colour: ■ RAL 7035 F.08

RACEWAYS WITH WIRED SOCKETS

ORD. NO.	type and number of wired sockets:					
	D	F	GB	I	CH	IL
F BL 9310 10 08	9	-	-	-	-	-
F BL 9310 20 08	-	9	-	-	-	-
F BL 9310 25 08	4	5	-	-	-	-
F BL 9310 30 08	-	-	6	-	-	-
F BL 9310 35 08	4	-	3	-	-	-
F BL 9310 40 08	-	-	-	9	-	-
F BL 9310 45 08	4	-	-	5	-	-
F BL 9310 50 08	-	-	-	-	9	-
F BL 9310 55 08	4	-	-	-	5	-
F BL 9310 70 08	-	-	-	-	-	9
F BL 9310 75 08	4	-	-	-	-	5

Dimensions: mm 1920x60x85 h Standard colour: ■ RAL 7035 F.08



WALDMANN SWIVEL LAMP WITH THREE JOINTS 1x36 W IP 20
ORD. NO. DIMENSIONS mm
F BL 9980 00 08 910x90x105 h
 Complete with multipurpose support
 Standard colour: ■ RAL 7035 F.08

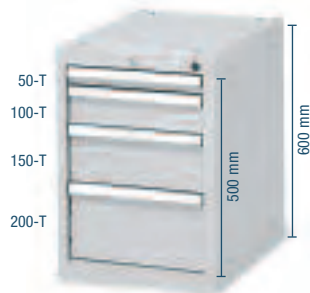

ORD. NO. DRAWERS
F DA 1050 52 08 4
 Cabinet with 4 full extension drawers
 Dim. mm 428x600x600 h Central lock
 Colours available: ■ 01 ■ 02 ■ 04 ■ 08



ORD. NO. DRAWERS
F DZ 1050 54 08 1
 Cabinet with 1 full extension drawer, 1 retractable shelf 100%
 Dim. mm 428x600x600 h Side lock
 Colours available: ■ 01 ■ 02 ■ 04 ■ 08



POLYURETHANE CHAIR
ORD. NO.
F QZ 2211 00 07
 Adjustable in height using a gas pump
 Height: from 495 to 670 mm
 Standard colour: ■ RAL 9011 F.07

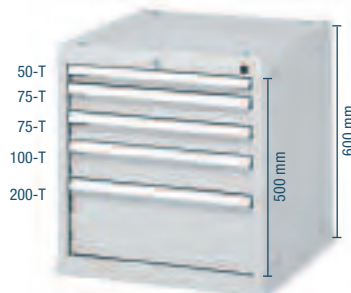

ORD. NO. DRAWERS
F DB 1050 53 08 5
 Cabinet with 5 full extension drawers
 Dim. mm 564x600x600 h Central lock
 Colours available: ■ 01 ■ 02 ■ 04 ■ 08

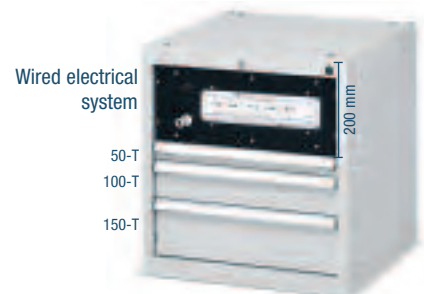

ORD. NO. DRAWERS
F DB 1050 55 08 3
 Cabinet with 3 full extension drawers, 1 magnetothermic switch, 5 Schuko sockets, 1 pneumatic hose (fast coupling not included)
 Dim. mm 564x600x600 h Central lock
 Colours available: ■ 01 ■ 02 ■ 04 ■ 08

KEY

- RAL 7000 F.01
- RAL 6011 F.02
- RAL 5012 F.04
- RAL 7035 F.08



- PE = full extension retractable shelf (100%)
- T = full extension (100%)
- All indicated loads are net and refer to evenly distributed weights

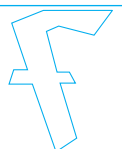

WORKSTATIONS DYNAMIC

DOUBLE SIDED BASE FRAME

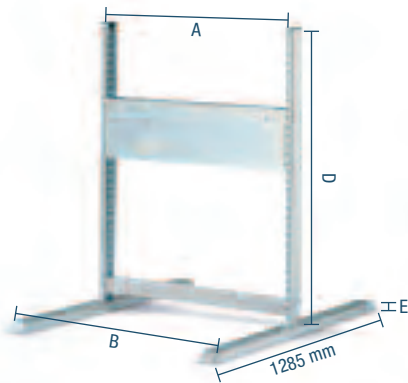

ORD. NO.	A mm	B mm	D mm	E mm
F LE A123 00 55	985	1067	1240	40
F LE A125 00 55	1470	1552	1240	40
Load capacity of 1 upright: 150 kg (75 kg per side)				
Standard colour: ■■ 55				

ADDITIONAL DOUBLE SIDED FRAME

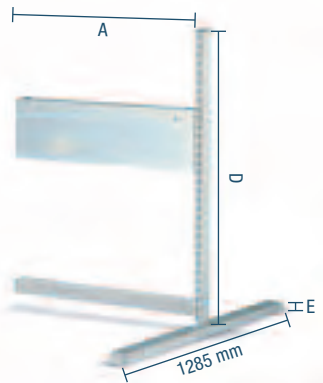

ORD. NO.	A mm	B mm	D mm	E mm
F LE B123 00 55	985	-	1240	40
F LE B125 00 55	1470	-	1240	40
Load capacity of 1 upright: 150 kg (75 kg per side)				
Standard colour: ■■ 55				

DOUBLE SIDED BASE FRAME

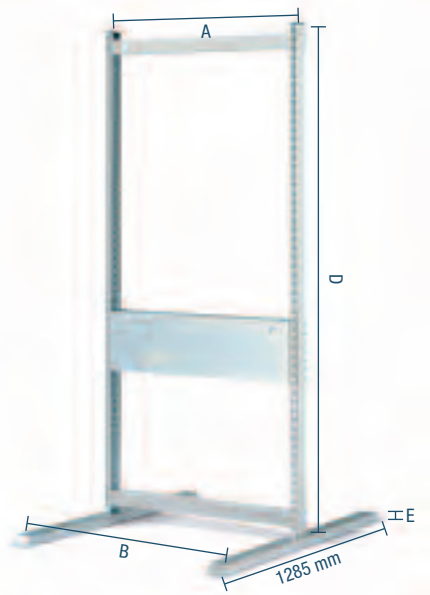

ORD. NO.	A mm	B mm	D mm	E mm
F LE G173 00 55	985	1067	1772	40
F LE G175 00 55	1470	1552	1772	40
F LE G213 00 55	985	1067	2152	40
F LE G215 00 55	1470	1552	2152	40
Load capacity of 1 upright: 150 kg (75 kg per side)				
Standard colour: ■■ 55				

SINGLE SIDED BASE FRAME

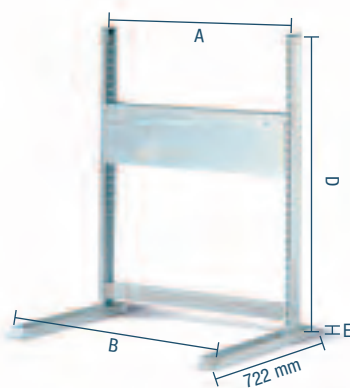

ORD. NO.	A mm	B mm	D mm	E mm
F LE D123 00 55	985	1067	1240	40
F LE D125 00 55	1470	1552	1240	40
Load capacity of 1 upright: 150 kg (75 kg per side)				
Standard colour: ■■ 55				

ADDITIONAL SINGLE SIDED FRAME



ORD. NO.	A mm	B mm	D mm	E mm
F LE E123 00 55	985	-	1240	40
F LE E125 00 55	1470	-	1240	40
Load capacity of 1 upright: 150 kg (75 kg per side)				
Standard colour: ■■ 55				

SINGLE SIDED BASE FRAME

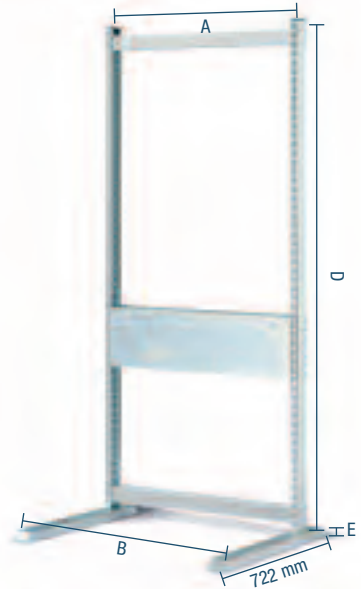

ORD. NO.	A mm	B mm	D mm	E mm
F LE K173 00 55	985	1067	1772	40
F LE K175 00 55	1470	1552	1772	40
F LE K213 00 55	985	1067	2152	40
F LE K215 00 55	1470	1552	2152	40
Load capacity of 1 upright: 150 kg (75 kg per side)				
Standard colour: ■■ 55				

RAL 7035+GALVANISED F.55

KEY ■

- Workstations are supplied not assembled
- Workstations must be fixed to the wall or floor
- All indicated loads are net and refer to evenly distributed weights



ADDITIONAL DOUBLE SIDED FRAME

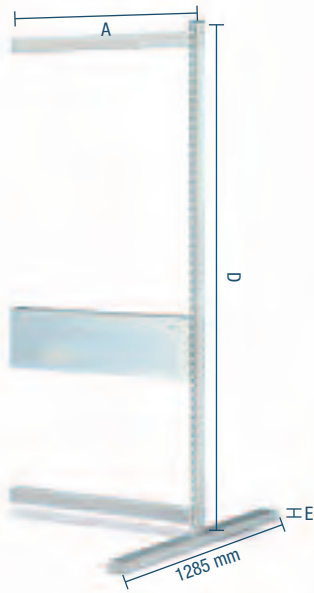

ORD. NO.	A mm	B mm	D mm	E mm
F LE H173 00 55	985	-	1772	40
F LE H175 00 55	1470	-	1772	40
F LE H213 00 55	985	-	2152	40
F LE H215 00 55	1470	-	2152	40

Load capacity of 1 upright: 150 kg (75 kg per side)
 Standard colour: ■■ 55



The central stiffening bar (bar with compartment) is used to fix the worktop; at the back there is space to house cables and hoses. On request, the compartment can be closed with a sheet metal profile.

ADDITIONAL SINGLE SIDED FRAME



ORD. NO.	A mm	B mm	D mm	E mm
F LE L173 00 55	985	-	1772	40
F LE L175 00 55	1470	-	1772	40
F LE L213 00 55	985	-	2152	40
F LE L215 00 55	1470	-	2152	40

Load capacity of 1 upright: 150 kg (75 kg per side)
 Standard colour: ■■ 55



■ KEY



- Workstations are supplied not assembled
- Workstations must be fixed to the wall or floor
- All indicated loads are net and refer to evenly distributed weights

■■ RAL 7035+GALVANISED F.....55

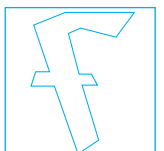

WORKSTATIONS SERIES DYNAMIC

WORKSTATIONS DYNAMIC

DOUBLE SIDED BASE FRAME

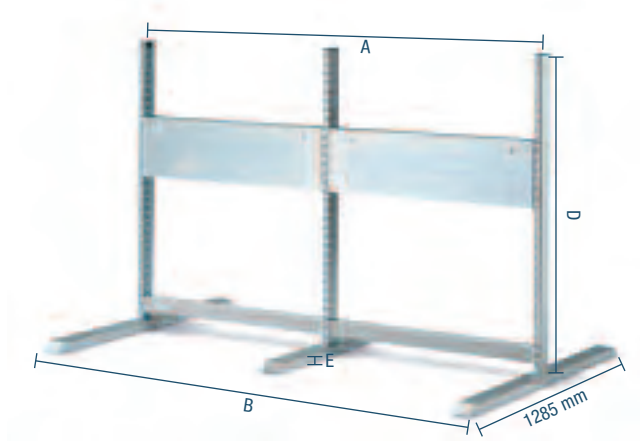

ORD. NO.	A mm	B mm	D mm	E mm
F LE N123 00 55	985+985	2052	1240	40
Load capacity of 1 upright: 150 kg (75 kg per side)				
Standard colour: ■■ 55				

ADDITIONAL DOUBLE SIDED FRAME

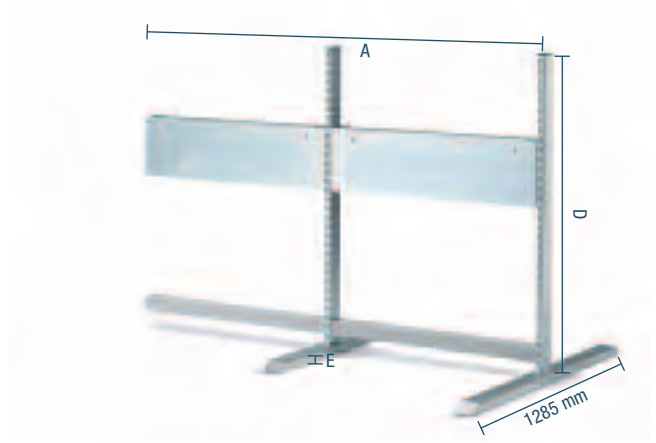

ORD. NO.	A mm	B mm	D mm	E mm
F LE P123 00 55	985+985	-	1240	40
Load capacity of 1 upright: 150 kg (75 kg per side)				
Standard colour: ■■ 55				

SINGLE SIDED BASE FRAME

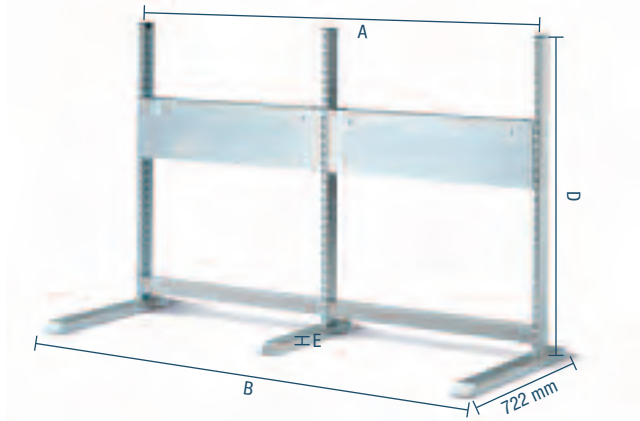

ORD. NO.	A mm	B mm	D mm	E mm
F LE R123 00 55	985+985	2052	1240	40
Load capacity of 1 upright: 150 kg (75 kg per side)				
Standard colour: ■■ 55				

ADDITIONAL SINGLE SIDED FRAME

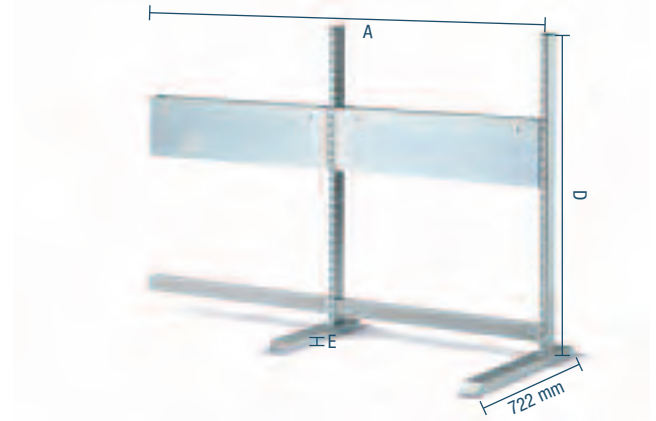

ORD. NO.	A mm	B mm	D mm	E mm
F LE S123 00 55	985+985	-	1240	40
Load capacity of 1 upright: 150 kg (75 kg per side)				
Standard colour: ■■ 55				

■ RAL 7035+GALVANISED F.55



KEY ■

- Workstations are supplied not assembled
- Workstations must be fixed to the wall or floor
- All indicated loads are net and refer to evenly distributed weights



DOUBLE SIDED BASE FRAME



ADDITIONAL DOUBLE SIDED FRAME



ORD. NO.	A mm	B mm	D mm	E mm
F LE T173 00 55	985+985	2052	1772	40
F LE T213 00 55	985+985	2052	2152	40
Load capacity of 1 upright: 150 kg (75 kg per side)				
Standard colour: ■■ 55				

ORD. NO.	A mm	B mm	D mm	E mm
F LE U173 00 55	985+985	-	1772	40
F LE U213 00 55	985+985	-	2152	40
Load capacity of 1 upright: 150 kg (75 kg per side)				
Standard colour: ■■ 55				

SINGLE SIDED BASE FRAME



ADDITIONAL SINGLE SIDED FRAME



ORD. NO.	A mm	B mm	D mm	E mm
F LE V173 00 55	985+985	2052	1772	40
F LE V213 00 55	985+985	2052	2152	40
Load capacity of 1 upright: 150 kg (75 kg per side)				
Standard colour: ■■ 55				

ORD. NO.	A mm	B mm	D mm	E mm
F LE X173 00 55	985+985	-	1772	40
F LE X213 00 55	985+985	-	2152	40
Load capacity of 1 upright: 150 kg (75 kg per side)				
Standard colour: ■■ 55				

■ KEY



- Workstations are supplied not assembled
- Workstations must be fixed to the wall or floor
- All indicated loads are net and refer to evenly distributed weights

■ ■ RAL 7035+GALVANISED F.....55

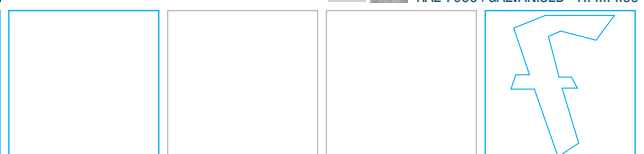

WORKSTATIONS SERIES DYNAMIC

WORKTOP WITH FRAME ADJUSTABLE IN HEIGHT FROM 720 mm TO 1138 mm

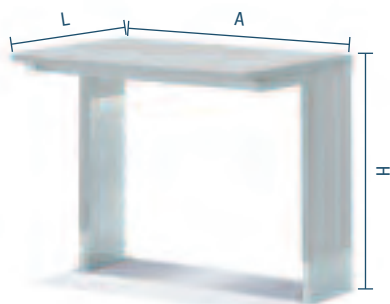

WORKTOP WITH FRAME ADJUSTABLE IN HEIGHT FROM 720 mm TO 1138 mm

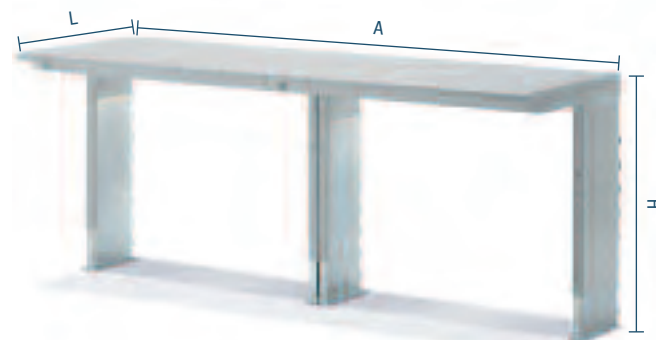

ORD. NO.	A mm	H mm	L mm
F LE 0960 A1 55	985	723 / 1141	600
F LE 1460 A1 55	1470	723 / 1141	600
F LE 0970 A1 55	985	723 / 1141	700
F LE 1470 A1 55	1470	723 / 1141	700

Height adjustment - distance 38 mm. Load cap. 200 kg
Standard colour: ■ 55

ORD. NO.	A mm	H mm	L mm
F LE 1960 A1 55	1970	723 / 1141	600
F LE 1970 A1 55	1970	723 / 1141	700

Height adjustment - distance 38 mm. Load cap. 300 kg
Standard colour: ■ 55



PAIR OF SUPPORTS

ORD. NO.
F BL 4600 00 08

Pair of supports for FLEXA series cabinets
For DYNAMIC series workstations only



LOCK FOR CABLE HOLDING COMPARTMENT

ORD. NO.	LENGTH mm
F BL 4610 00 99	954
F BL 4615 00 99	1439

For DYNAMIC series frames only
Standard colour: ■ 99

RAL 7035+GALVANISED F.55

GALVANISED F.99

KEY ■

- Workstations are supplied not assembled
- Workstations must be fixed to the wall or floor
- All indicated loads are net and refer to evenly distributed weights

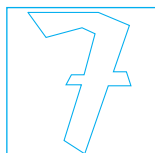

WORKSTATIONS DYNAMIC

1 DUAL SLOT UPRIGHT

ORD. NO.	HEIGHT mm
F BL 7540 02 99	1240
F BL 7547 02 99	1772
F BL 7555 02 99	2152

Colours available:

■ 01	■ 02	■ 04	■ 08	■ 99
------	------	------	------	------

4 PAIR OF CAPS

ORD. NO.
F BL 4420 00 07

Standard colour: ■ 07

6 DOUBLE SIDED SIDE FOOT

ORD. NO.	LENGTH mm
F BL 4520 00 99	1285

Standard colour: ■ 99

7 DOUBLE SIDED CENTRAL FOOT

ORD. NO.	LENGTH mm
F BL 4525 00 99	925

Standard colour: ■ 99

For use with the 1970 mm long worktop only

8 SINGLE SIDED SIDE FOOT

ORD. NO.	LENGTH mm
F BL 4530 00 99	722

Standard colour: ■ 99

9 SINGLE SIDED CENTRAL FOOT

ORD. NO.	LENGTH mm
F BL 4535 00 99	542

Standard colour: ■ 99

For use with the 1970 mm long worktop only

14 WORKTOP COVERED WITH GREY LAMINATE

ORD. NO.	DIMENSIONS mm
F BS 0960 00 08	985x600x30 h
F BS 0970 00 08	985x700x30 h
F BS 1460 00 08	1470x600x30 h
F BS 1470 00 08	1470x700x30 h
F BS 1960 00 08	1970x600x30 h
F BS 1970 00 08	1970x700x30 h

Hardboard worktop covered with grey laminate

15 BAR WITH COMPARTMENT

ORD. NO.	LENGTH mm
F BL 4620 00 99	955 (A=985)
F BL 4625 00 99	1440 (A=1470)

Standard colour: ■ 99

16 BAR

ORD. NO.	LENGTH mm
F BL 4630 00 08	969 (A=985)
F BL 4635 00 08	1455 (A=1470)

Colours available:

■ 01	■ 02	■ 04	■ 08
------	------	------	------

17 WORKTOP FRAME

ORD. NO.	DIMENSIONS mm
F BL 4650 00 08	984x551
F BL 4655 00 08	1469x551

Two 985 mm frames are necessary to fix a 1970 mm long worktop

Colours available:

■ RAL 7000	F.01
■ RAL 6011	F.02
■ RAL 5012	F.04
■ RAL 7035	F.08

17.1 PAIR OF EXTENSIBLE UPRIGHTS

ORD. NO.	HEIGHT mm
F BL 4670 00 55	611/1029

Colours available:

■ GALVANISED+RAL 7000	F.52
■ GALVANISED+RAL 6011	F.53
■ GALVANISED+RAL 5012	F.54
■ GALVANISED+RAL 7035	F.55

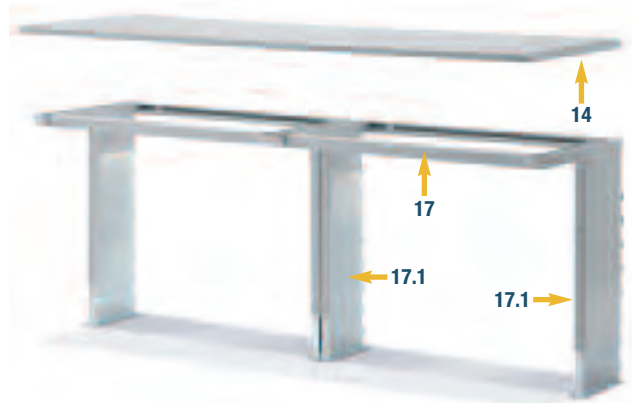
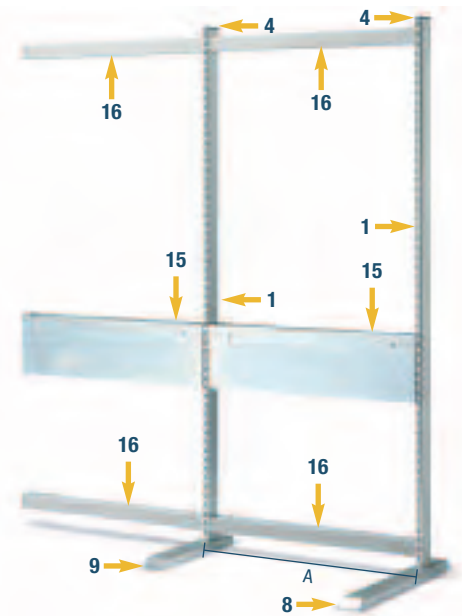
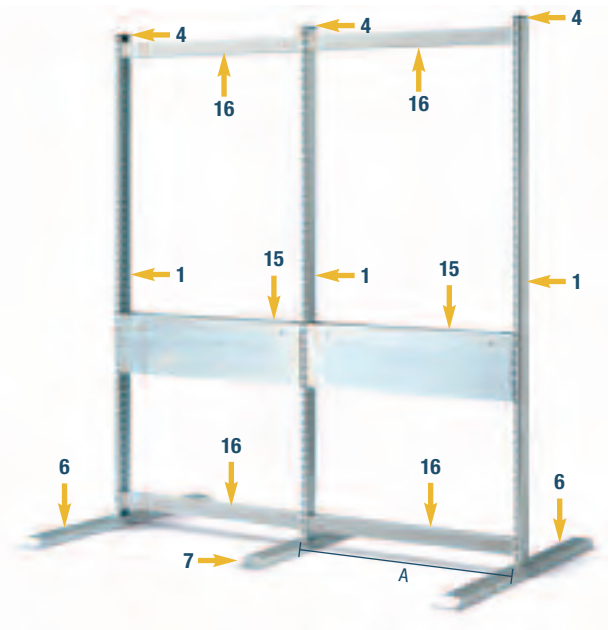

KEY

■ RAL 7000	F.01	■ RAL 6011	F.02	■ RAL 5012	F.04	■ RAL 7035	F.08	■ GALVANISED	F.99
------------	-----------	------------	-----------	------------	-----------	------------	-----------	--------------	-----------



- Workstations are supplied not assembled
- Workstations must be fixed to the wall or floor
- All indicated loads are net and refer to evenly distributed weights

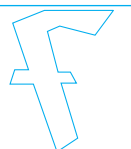

ACCESSORIES

ACCESSORIES FOR SLICK / COMFORT / DYNAMIC

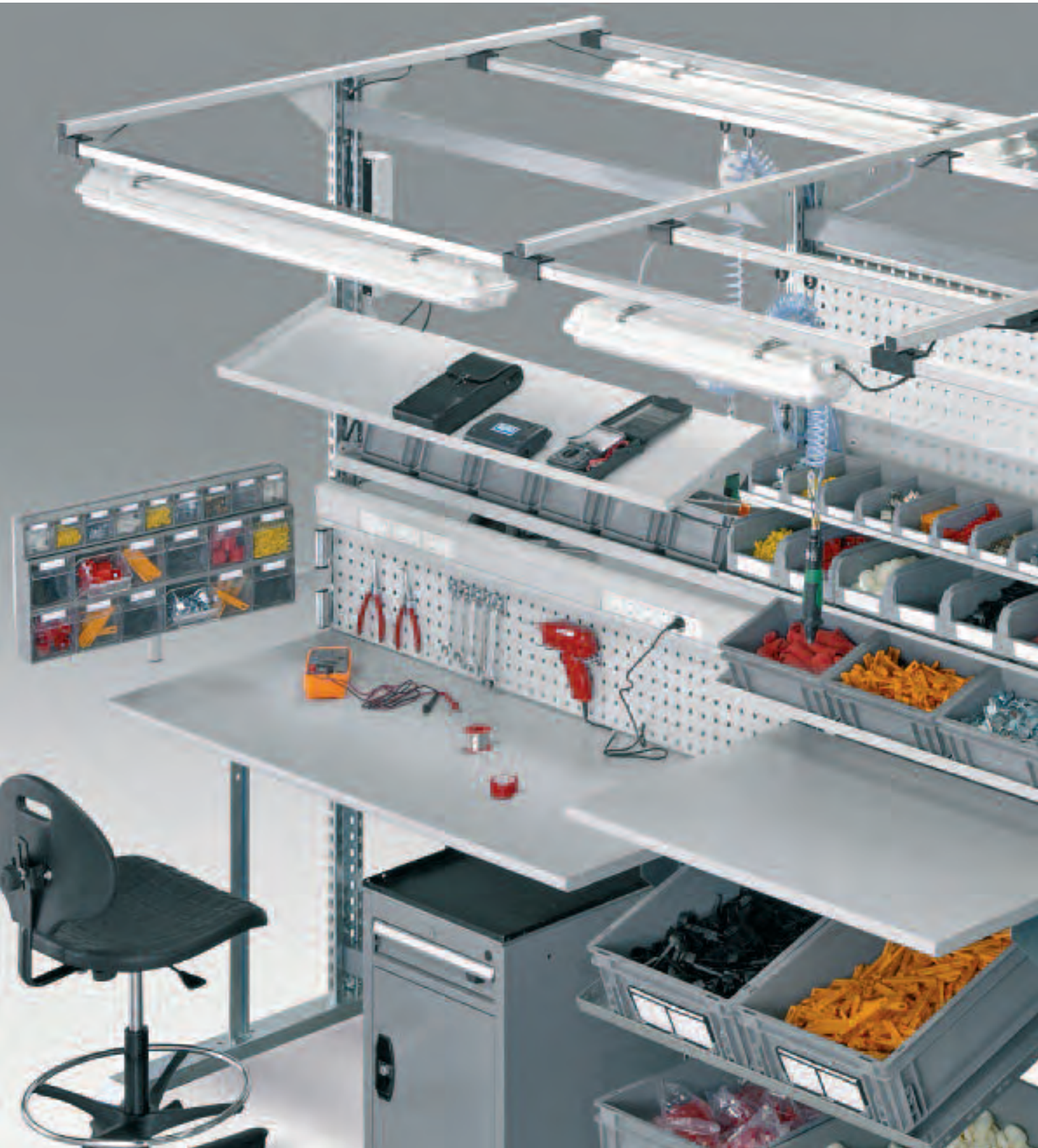

RAL 7000 F.01

RAL 6011 F.02

RAL 5012 F.04

RAL 7035 F.08

INFO ■

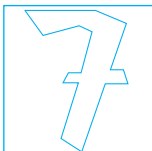
www.famispa.com

ACCESSORIES FOR
SLICK / COMFORT / DYNAMIC

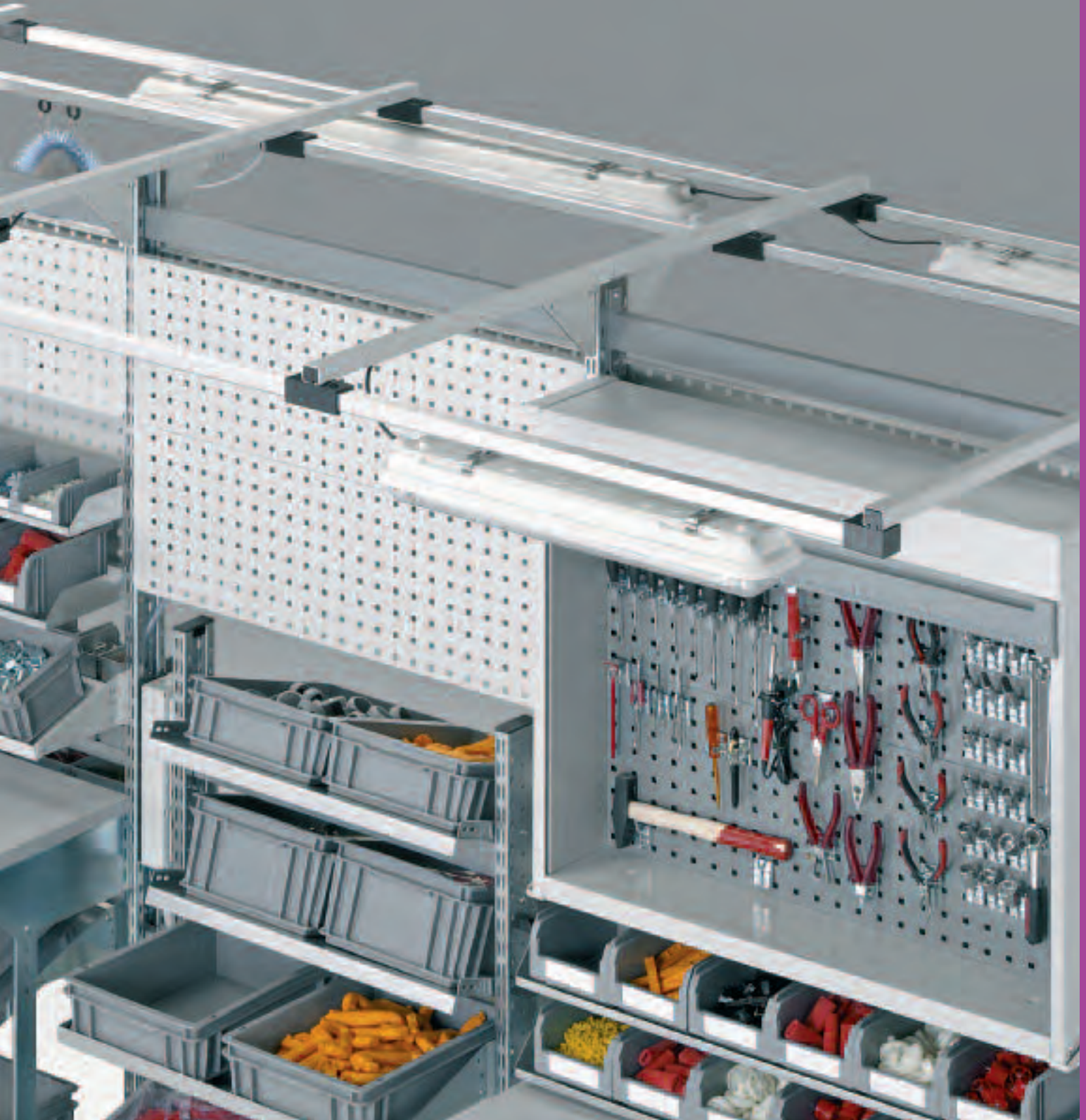

■ INFO

RAL 7000 F.01 RAL 6011 F.02 RAL 5012 F.04 RAL 7035 F.08



www.famispa.com

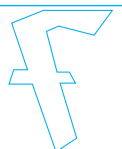

ACCESSORIES

ACCESSORIES FOR SLICK / COMFORT / DYNAMIC



TILTING SHELVES LENGTH 1440 mm

ORD. NO.	DEPTH mm
F BL 7795 00 99	220 (A=1470)
F BL 7800 00 99	320 (A=1470)
F BL 7805 00 99	420 (A=1470)

Load capacity 50 kg

Colours available:

■ 01 ■ 02 ■ 04 ■ 08 ■ 99

TILTING SHELVES LENGTH 955 mm

ORD. NO.	DEPTH mm
F BL 7750 00 99	220 (A=985)
F BL 7755 00 99	320 (A=985)
F BL 7760 00 99	420 (A=985)
F BL 7762 00 99	600 (A=985)

Load capacity 50 kg

Colours available:

■ 01 ■ 02 ■ 04 ■ 08 ■ 99

■ RAL 7000 F. 01 ■ RAL 6011 F. 02 ■ RAL 5012 F. 04 ■ RAL 7035 F. 08 ■ GALVANISED F. 99

KEY ■

■ All indicated loads are net and refer to evenly distributed weights



ACCESSORIES FOR SLICK / COMFORT / DYNAMIC

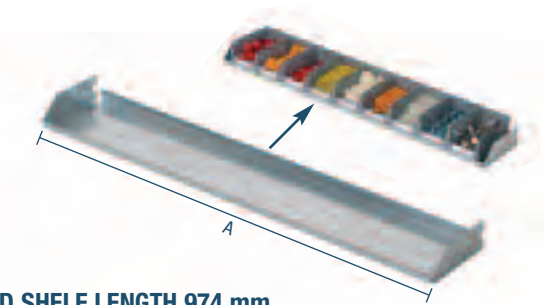

FIXED SHELF LENGTH 974 mm

ORD. NO.	DEPTH mm
F BL 7846 00 99	150 (A=985)
Dimensions: 974x170x61 mm h	
Load capacity 25 kg. Capacity: 9 containers size 1	
Standard colour: ■ 99	

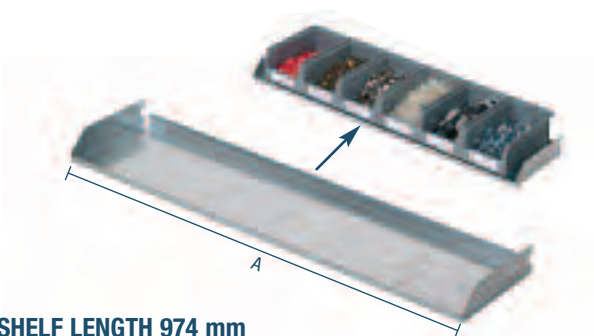

FIXED SHELF LENGTH 974 mm

ORD. NO.	DEPTH mm
F BL 7847 00 99	205 (A=985)
Dimensions: 974x230x61 mm h	
Load capacity 25 kg. Capacity: 6 containers size 2	
Standard colour: ■ 99	

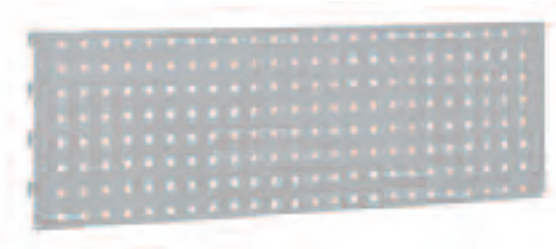
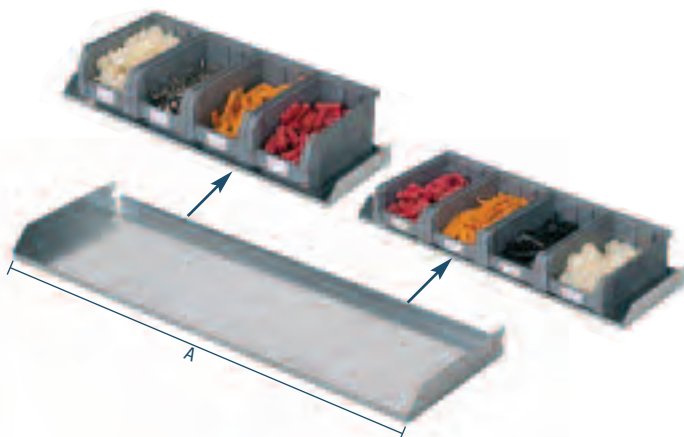

PERFORATED PANEL

ORD. NO.	DIMENSIONS mm
F BL 7620 00 08	973 (A=985)
F BL 7635 00 08	1458 (A=1470)
Perforated panel that can be hooked onto the dual slot uprights.	
Colours available:	
■ 01 ■ 02 ■ 04 ■ 08	



NON-PERFORATED PANEL

ORD. NO.	DIMENSIONS mm
F BL 7670 00 08	973 (A=985)
F BL 7685 00 08	1458 (A=1470)
Non-perforated panel that can be hooked onto the dual slot uprights.	
Colours available:	
■ 01 ■ 02 ■ 04 ■ 08	

FIXED SHELF LENGTH 974 mm

ORD. NO.	DEPTH mm
F BL 7848 00 99	295 (A=985)
Dimensions: 974x315x61 mm h	
Load capacity 25 kg. Capacity: 4 containers size 3A2 / size 3	
Standard colour: ■ 99 GALVANISED	

■ KEY

■ RAL 7000 F. 01	■ RAL 6011 F. 02	■ RAL 5012 F. 04	■ RAL 7035 F. 08	■ GALVANISED F. 99
--------------------------	--------------------------	--------------------------	--------------------------	----------------------------



■ All indicated loads are net and refer to evenly distributed weights

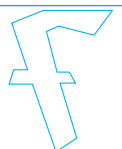

ACCESSORIES

ACCESSORIES FOR SLICK / COMFORT / DYNAMIC

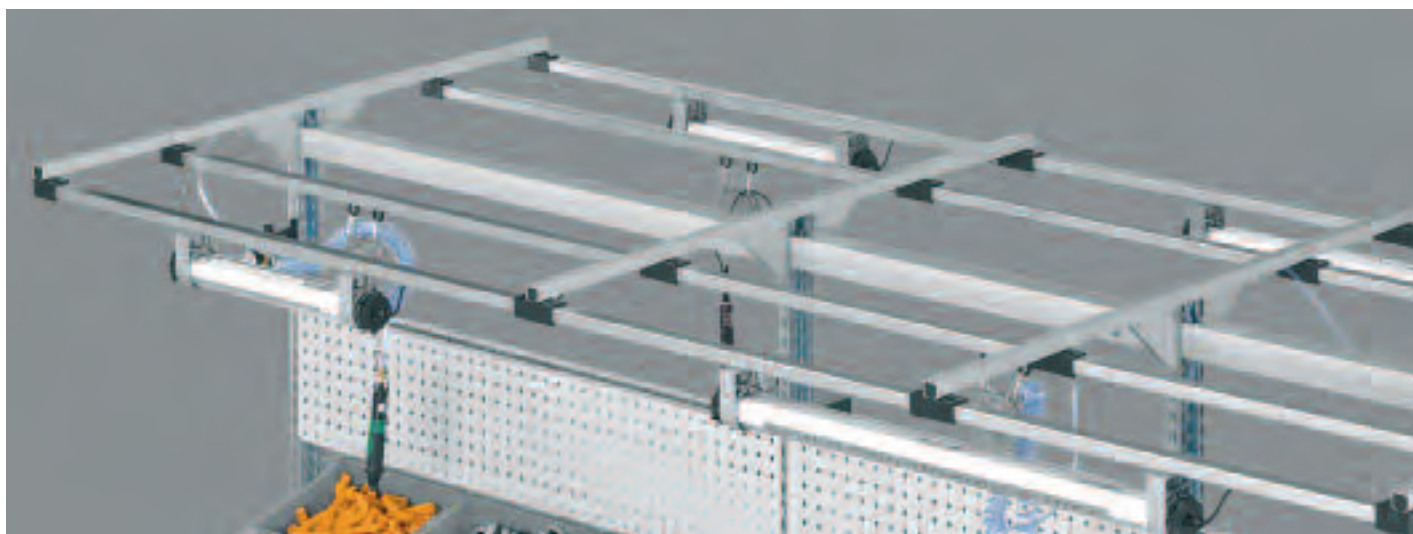

18 PAIR OF SUPPORTS WITH BASE TRACK

ORD. NO.	DIMENSIONS mm
----------	---------------

F BL 9810 01 55	985x750 (A = 985)
-----------------	-------------------

F BL 9815 01 55	1470x750 (A = 1470)
-----------------	---------------------

Load capacity 10 kg

Colours available:

- ALUMINIUM + RAL 7000 F. 52
- ALUMINIUM + RAL 6011 F. 53
- ALUMINIUM + RAL 5012 F. 54
- ALUMINIUM + RAL 7035 F. 55

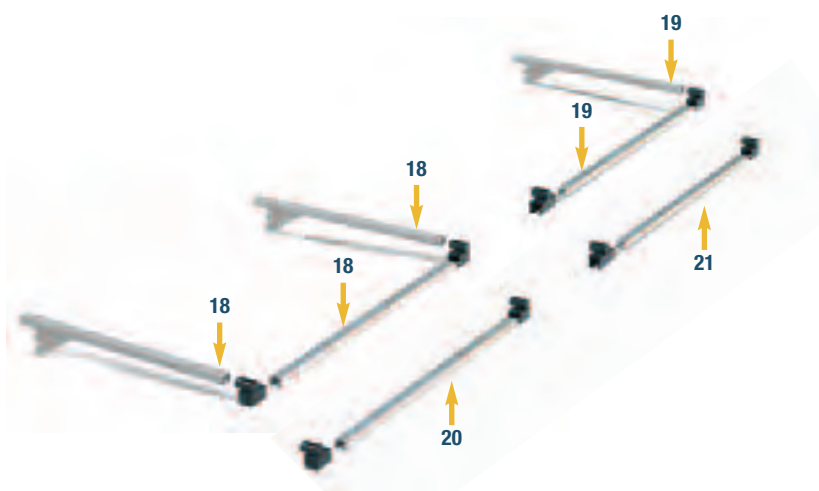

19 SUPPORT WITH ADDITIONAL TRACK

ORD. NO.	DIMENSIONS mm
----------	---------------

F BL 9810 03 55	985x750 (A = 985)
-----------------	-------------------

F BL 9815 03 55	1470x750 (A = 1470)
-----------------	---------------------

Load capacity 10 kg

Colours available:

- ALUMINIUM + RAL 7000 F. 52
- ALUMINIUM + RAL 6011 F. 53
- ALUMINIUM + RAL 5012 F. 54
- ALUMINIUM + RAL 7035 F. 55

20 BASE TRACK

ORD. NO.	LENGTH mm
----------	-----------

F BL 9810 10 00	A 985
-----------------	-------

F BL 9815 10 00	A 1470
-----------------	--------

Standard colour:

- 00 ALUMINIUM

21 ADDITIONAL TRACK

ORD. NO.	LENGTH mm
----------	-----------

F BL 9810 13 00	A 985
-----------------	-------

F BL 9815 13 00	A 1470
-----------------	--------

Standard colour:

- 00 ALUMINIUM

COUPLINGS

ORD. NO.	
----------	--

F BL 9841 00 07	22+23
-----------------	-------

F BL 9840 00 07	24
-----------------	----

Standard colour:

- 07 BLACK RAL 9011



ALUMINIUM + RAL 7000 F. 52	ALUMINIUM + RAL 6011 F. 53	ALUMINIUM + RAL 5012 F. 54	ALUMINIUM + RAL 7035 F. 55
---------------------------------	---------------------------------	---------------------------------	---------------------------------

KEY ■

■ All indicated loads are net and refer to evenly distributed weights



ACCESSORIES FOR SLICK / COMFORT / DYNAMIC

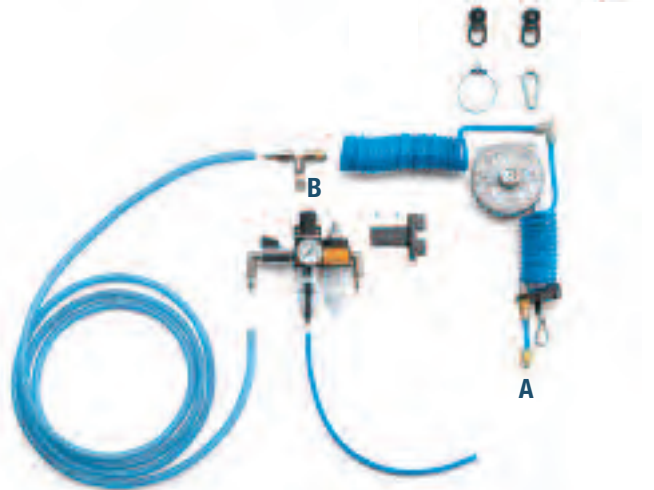

COMPRESSED AIR SET WITH BALANCER AND FILTER

ORD. NO.	BALANCER
F BL 9710 03 00	0.4 - 1 kg
F BL 9720 03 00	1 - 2 kg

The set includes: 1 flexible cable Ø 10 mm, 1 T-shaped connector 1/4" with cap (B), 2 retainers, 2 support runners, 1 snap hook, 1 balancer with 1600 mm long steel cable, 1 universal tool coupling 1/4" (A), 1 spiral tube internal diameter 5.5 mm, 1 filter regulator unit with pressure gauge* which can be used at a maximum pressure of 10 bar, it has a capacity of about 9 litres per second (at point A) and 11 litres per second (at point B) at an operating pressure of 6.3 bar (the capacity can vary according to the technical characteristics of the compressed air supply to which the Fami system is connected). 1/4" unions, 1 tube internal diameter 5.5 mm to drain the filter.

* Filter regulator unit with pressure gauge and oiler on request

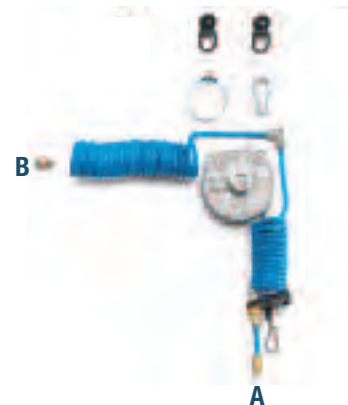

ADDITIONAL COMPRESSED AIR SET WITH BALANCER

ORD. NO.	BALANCER
F BL 9710 02 00	0.4 - 1 kg
F BL 9720 02 00	1 - 2 kg

The set includes: 1 coupling 1/4" (B), 2 retainers, 2 support runners, 1 snap hook, 1 balancer with 1600 mm long steel cable, 1 universal tool coupling (A), 1 spiral tube internal diameter 5.5 mm



SUPPORT RUNNERS

ORD. NO.

R CMV 0034 00

The support runner is made up of 1 black plastic ring complete with bearings and 1 steel snap hook



BALANCER SET

ORD. NO.	BALANCER
F BL 9710 00 00	0.4 - 1 kg
F BL 9720 00 00	1 - 2 kg

The set includes: 2 support runners, 1 snap hook, 1 balancer with 1600 mm long steel cable

■ INFO



www.famisp.com

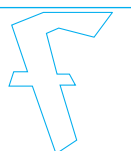

ACCESSORIES

ACCESSORIES FOR SLICK / COMFORT / DYNAMIC



ANTI-GLARE HOOD FOR PHILIPS LAMPS

ORD. NO.	FOR LAMP
F BL 9921 00 08	2x18W
F BL 9922 00 08	2x36W

Standard colour: ■ 08



PHILIPS LAMP IP 66 2X18 W

ORD. NO.	DIMENSIONS mm
F BL 9905 00 00	700x140x85 h

Technical specifications of the lamp:

Polyester casing, cover in transparent polycarbonate, protection rating IP 66, neon 2x18W, electrical input 230V/50Hz, power supply plug Schuko, cable length 4 metres, tonality 4000K, colour rendering (Ra) 80-89. Fixing material included.

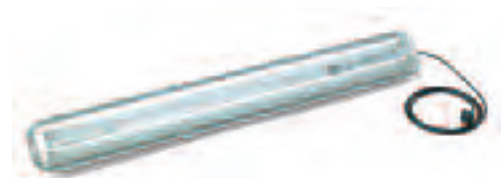

PHILIPS LAMP IP 66 2X36 W

ORD. NO.	DIMENSIONS mm
F BL 9910 00 00	1300x165x95 h

Technical specifications of the lamp:

Polyester casing, cover in transparent polycarbonate, protection rating IP 66, neon 2x36W, electrical input 230V/50Hz, power supply plug Schuko, cable length 4 metres, tonality 4000K, colour rendering (Ra) 80-89. Fixing material included.

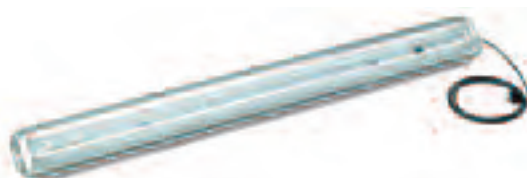

PHILIPS LAMP IP 66 2X58 W

ORD. NO.	DIMENSIONS mm
F BL 9915 00 00	1600x165x95 h

Technical specifications of the lamp:

Polyester casing, cover in transparent polycarbonate, protection rating IP 66, neon 2x58W, electrical input 230V/50Hz, power supply plug Schuko, cable length 4 metres, tonality 4000K, colour rendering (Ra) 80-89. Fixing material included.

RAL 7035 F.08

INFO ■

www.famispa.com





WALDMANN LAMP IP 67 1x36 W

ORD. NO.	DIMENSIONS mm
F BL 9955 00 00	610x70 h

Technical specifications of the lamp:
borosilicate glass tube, parabolic diffuser, protection rating IP 67, neon 2x36W, electrical input 230V/50Hz, power supply plug Schuko, cable length 4 metres, tonality 4000K, colour rendering (Ra) 80-89. Fixing material included.



WALDMANN LAMP IP 67 2x36 W

ORD. NO.	DIMENSIONS mm
F BL 9960 00 00	1090x70 h

Technical specifications of the lamp:
borosilicate glass tube, parabolic diffuser, protection rating IP 67, neon 2x36W, electrical input 230V/50Hz, power supply plug Schuko, cable length 4 metres, tonality 4000K, colour rendering (Ra) 80-89. Fixing material included.

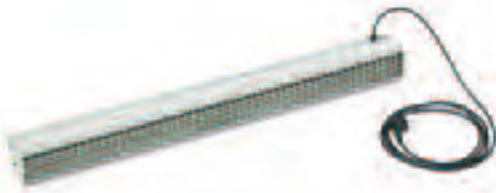

WALDMANN LAMP IP 20 2x36 W

ORD. NO.	DIMENSIONS mm
F BL 9930 00 08	910x90x105 h

Technical specifications of the lamp:
aluminium casing, metallic parabolic diffuser, protection rating IP 20, neon 2x36W, electrical input 230V/50Hz, power supply plug Schuko, cable length 2,95 metres, tonality 4000K, colour rendering (Ra) 80-89. Fixing material included.

Standard colour: ■ 08

ACCESSORIES FOR SLICK / COMFORT / DYNAMIC

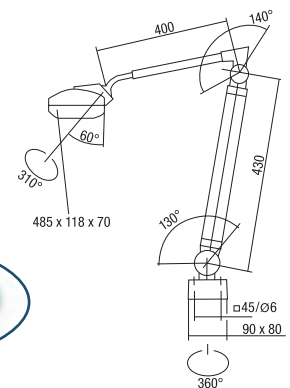

TRIPLE-JOINTED WALDMANN LAMP 1x36 W IP 20

ORD. NO.	DIMENSIONS mm
F BL 9980 00 08	910x90x105 h

Technical specifications of the lamp:
aluminium casing, metallic parabolic diffuser, protection rating IP 20, neon 1x36W, electrical input 230V/50Hz, power supply plug Schuko, cable length 1,95 metres, tonality 4000K, colour rendering (Ra) 80-89. Fixing material included.

The standard lighting system includes:
1 multipurpose steel support for fixing to clamp, 1 clamp 0-65 mm, 1 swivel lamp with three joints.

Standard colour: ■ 08



MULTIPURPOSE SUPPORT
ORD. NO. F BL 7461 00 08
 Dim. 70x60x70 mm
Standard colour: ■ 08

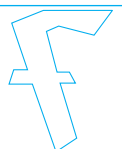

ACCESSORIES

ACCESSORIES FOR SLICK / COMFORT / DYNAMIC



Standard IP 30 protection rating electrical components supplied:

- 2 multiple socket boxes with 12 modules
- 1 magnetothermal differential circuit breaker 2P 230V AC10A I Δ N=0.01A
- 2 cable clamps PG11
- 1 cable clamp PG16

- 2 straight connectors PG16
- 200 cm cable sheath Ø 16 mm
- 1 heavy duty fixed plug 220-250V 16A 2P+T
- 1 complete wiring for 6-9 sockets (depending on the article)
- 6-9 sockets 220-250V 10A 2P+T with hole covers (depending on the article)



RACEWAYS WITH WIRED SOCKETS

ORD. NO.	type and number of wired sockets:					
	D	F	GB	I	CH	IL
F BL 9310 10 08	9	-	-	-	-	-
F BL 9310 20 08	-	9	-	-	-	-
F BL 9310 25 08	4	5	-	-	-	-
F BL 9310 30 08	-	-	6	-	-	-
F BL 9310 35 08	4	-	3	-	-	-
F BL 9310 40 08	-	-	-	9	-	-
F BL 9310 45 08	4	-	-	5	-	-
F BL 9310 50 08	-	-	-	-	9	-
F BL 9310 55 08	4	-	-	-	5	-
F BL 9310 70 08	-	-	-	-	-	9
F BL 9310 75 08	4	-	-	-	-	5

Dimensions: mm 1920x60x85 h

Standard colour: ■ 08

RACEWAYS WITH WIRED SOCKETS

ORD. NO.	type and number of wired sockets:					
	D	F	GB	I	CH	IL
F BL 9260 10 08	9	-	-	-	-	-
F BL 9260 20 08	-	9	-	-	-	-
F BL 9260 25 08	4	5	-	-	-	-
F BL 9260 30 08	-	-	6	-	-	-
F BL 9260 35 08	4	-	3	-	-	-
F BL 9260 40 08	-	-	-	9	-	-
F BL 9260 45 08	4	-	-	5	-	-
F BL 9260 50 08	-	-	-	-	9	-
F BL 9260 55 08	4	-	-	-	5	-
F BL 9260 70 08	-	-	-	-	-	9
F BL 9260 75 08	4	-	-	-	-	5

Dimensions: mm 1420x60x85 h

Standard colour: ■ 08

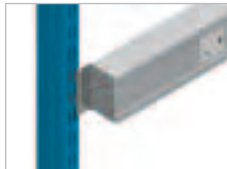

PAIR OF FRONT SUPPORTS

ORD. NO. F BL 9450 00 99

Pair of supports for fixing to front raceway

Standard colour: ■ 99 GALVANISED



PAIR OF REAR SUPPORTS

ORD. NO. F BL 9455 00 99

Pair of supports for fixing to rear raceway

Standard colour: ■ 99 GALVANISED

For 1940 mm long raceways with pair of rear supports please contact Fami

GALVANISED F.99

RAL 7035 F.08

INFO ■

www.famispa.com



ACCESSORIES FOR SLICK / COMFORT / DYNAMIC



Multiple socket box with side support

MULTIPLE SOCKET BOX 220V IP30 WITH SIDE SUPPORT

ORD. NO.	type and number of wired sockets:					
	D	F	GB	I	CH	IL
F BL 9361 10 59	5	-	-	-	-	-
F BL 9361 25 59	1	4	-	-	-	-
F BL 9361 30 59	-	-	3	-	-	-
F BL 9361 35 59	1	-	2	-	-	-
F BL 9361 45 59	1	-	-	4	-	-
F BL 9361 55 59	1	-	-	-	4	-
F BL 9361 75 59	1	-	-	-	-	4

Dimensions: mm 85x70x360 h

Standard colour: ■ 59

Standard IP 30 protection rating electrical components supplied:

- 1 multiple socket box with 12 modules
- 1 magnetothermic differential circuit breaker 2P 230V AC10A I Δ N=0.01A
- 2 straight connectors PG16, cm 200 cable sheath Ø 16 mm
- 1 heavy duty fixed plug 220-250V 16A 2P+T
- 1 complete wiring for 3-5 sockets (depending on the article)
- 3-5 sockets 220-250V 10A 2P+T with hole covers (depending on the article)

ACCESSORIES FOR SLICK / COMFORT / DYNAMIC



Multiple socket box with front support

MULTIPLE SOCKET BOX 220V IP30 WITH FRONT SUPPORT

ORD. NO.	type and number of wired sockets:					
	D	F	GB	I	CH	IL
F BL 9360 10 59	5	-	-	-	-	-
F BL 9360 25 59	1	4	-	-	-	-
F BL 9360 30 59	-	-	3	-	-	-
F BL 9360 35 59	1	-	2	-	-	-
F BL 9360 45 59	1	-	-	4	-	-
F BL 9360 55 59	1	-	-	-	4	-
F BL 9360 75 59	1	-	-	-	-	4

Dimensions: mm 85x70x360 h

Standard colour: ■ 59

Standard IP 30 protection rating electrical components supplied:

- 1 multiple socket box with 12 modules
- 1 magnetothermic differential circuit breaker 2P 230V AC10A I Δ N=0.01A
- 2 straight connectors PG16, cm 200 cable sheath Ø 16 mm
- 1 heavy duty fixed plug 220-250V 16A 2P+T
- 1 complete wiring for 3-5 sockets (depending on the article)
- 3-5 sockets 220-250V 10A 2P+T with hole covers (depending on the article)

■ INFO

RAL 7035+
RAL 9011 F.59



www.famispa.com

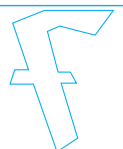

ACCESSORIES

ACCESSORIES FOR SLICK / COMFORT / DYNAMIC

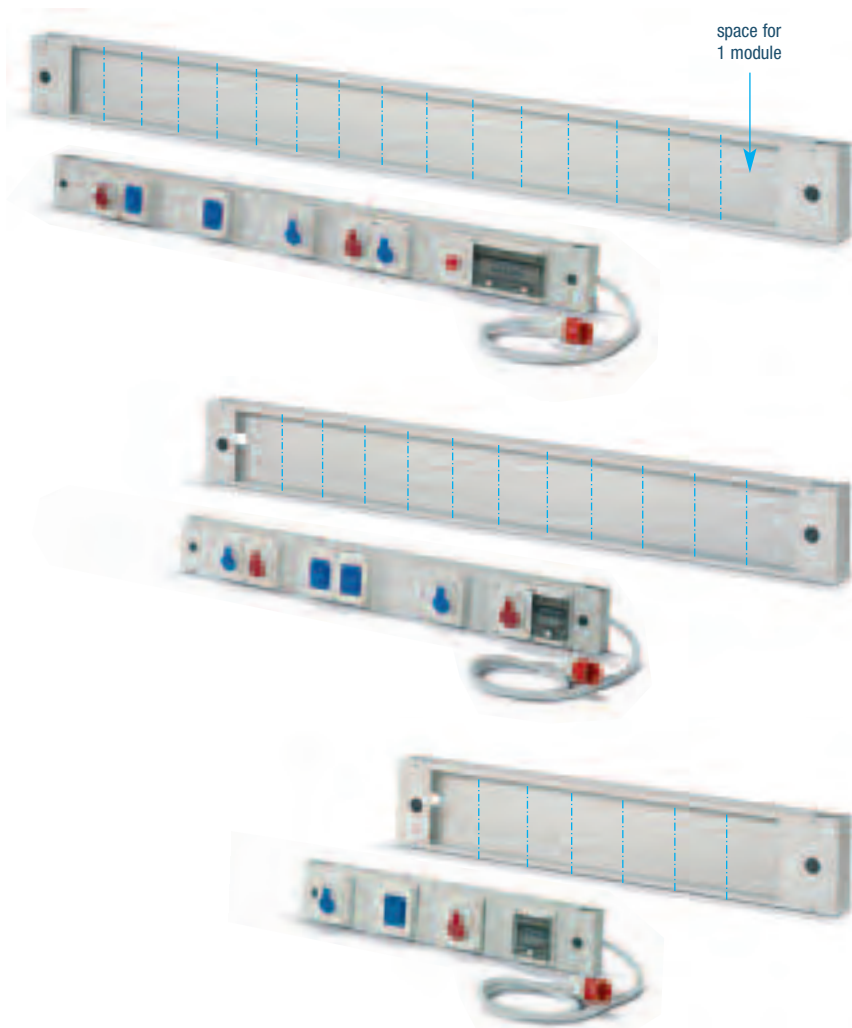
**EMPTY RACEWAY 16 MODULES 220V – 380V**

ORD. NO.	DIMENSIONS mm	MODULES
F BL 9120 01 08	1920x72x170 h	16

F BL 9120 01 08	1920x72x170 h	16
-----------------	---------------	----

For 1970 mm long frames

Empty raceway complete with 2 side plugs with holes for the pneumatic systems. Holes Ø 22 mm

Standard colour: ■ 08

EMPTY RACEWAY 12 MODULES 220V – 380V

ORD. NO.	DIMENSIONS mm	MODULES
F BL 9115 01 08	1420x72x170 h	12

F BL 9115 01 08	1420x72x170 h	12
-----------------	---------------	----

For 1470 mm long frames

Empty raceway complete with 2 side plugs with holes for the pneumatic systems. Holes Ø 22 mm

Standard colour: ■ 08

EMPTY RACEWAY 7 MODULES 220V – 380V

ORD. NO.	DIMENSIONS mm	MODULES
F BL 9110 01 08	935x72x170 h	7

F BL 9110 01 08	935x72x170 h	7
-----------------	--------------	---

For 985 mm long frames

Empty raceway complete with 2 side plugs with holes for the pneumatic systems. Holes Ø 22 mm

Standard colour: ■ 08

PAIR OF FRONT SUPPORTS**ORD. NO. F BL 9460 00 99**

Pair of supports for fixing to front raceway

Standard colour: ■ 99 GALVANISED

**PAIR OF REAR SUPPORTS****ORD. NO. F BL 9465 00 99**

Pair of supports for fixing to rear raceway

Standard colour: ■ 99 GALVANISED



For 1920 mm long raceways with pair of rear supports please contact Fami

GALVANISED F.99 RAL 7035 F.08

INFO ■

www.famispa.com



1 MODULE

MAGNETOTHERMIC DIFFERENTIAL CIRCUIT BREAKER 220V

ORD. NO.

WIRING

F BL 9393 51 00	YES
F BL 9393 52 00	NO

Made up of: control unit with cover, magnetothermic differential circuit breaker 220V 16A 1P+N
I Δ N=0.03A, 3 metres cable with wander plug CEE 220V

Protection rating IP40

The cable is supplied with the control unit is wired only



1 MODULE

MAGNETOTHERMIC DIFFERENTIAL CIRCUIT BREAKER 220V

ORD. NO.

WIRING

F BL 9394 51 00	YES
F BL 9394 52 00	NO

Made up of: control unit with cover, magnetothermic differential circuit breaker 220V 16A 1P+N,
3 metres cable with wander plug CEE 220V

Protection rating IP40

The cable is supplied with the control unit is wired only



1 MODULE

MAGNETOTHERMIC DIFFERENTIAL CIRCUIT BREAKER 380V

ORD. NO.

WIRING

F BL 9393 53 00	YES
F BL 9393 54 00	NO

Made up of: control unit with cover, magnetothermic differential circuit breaker 380V 16A 4P
I Δ N=0.03A, 3 metres cable with wander plug CEE 380V

Protection rating IP40

The cable is supplied with the control unit is wired only



2 MODULES

MAGNETOTHERMIC DIFFERENTIAL CIRCUIT BREAKER 220V

ORD. NO.

WIRING

F BL 9393 55 00	YES
F BL 9393 56 00	NO

Made up of: control unit with cover, magnetothermic differential circuit breaker 220V 16A 1P+N
I Δ N=0.03A with emergency cut off device,
1 emergency push button, 3 metres cable with wander plug CEE 220V. Protection rating IP40

The cable is supplied with the control unit is wired only



2 MODULES

MAGNETOTHERMIC DIFFERENTIAL CIRCUIT BREAKER 220V

ORD. NO.

WIRING

F BL 9394 55 00	YES
F BL 9394 56 00	NO

Made up of: control unit with cover, magnetothermic differential circuit breaker 220V 16A 1P+N
with emergency cut off device, 1 emergency push button, 3 metres cable with wander plug CEE 220V
Protection rating IP40

The cable is supplied with the control unit is wired only



3 MODULES

MAGNETOTHERMIC DIFFERENTIAL CIRCUIT BREAKER 380V

ORD. NO.

WIRING

F BL 9393 57 00	YES
F BL 9393 58 00	NO

Made up of: control unit with cover, magnetothermic differential circuit breaker 380V 16A 4P
I Δ N=0.03A with emergency cut off device,
1 emergency push button, 3 metres cable with wander plug CEE 380V. Protection rating IP40

The cable is supplied with the control unit is wired only



1 MODULE

SCHUKO SOCKET

ORD. NO.

WIRING

F BL 9395 57 00	YES
F BL 9395 58 00	NO

Made up of: 1 socket 220V 16A 2P+T

Protection rating IP40

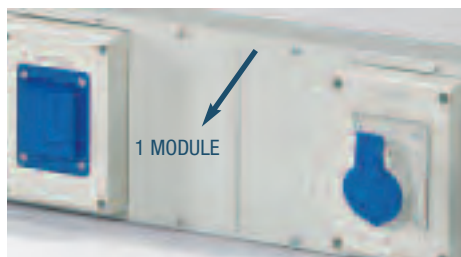

1 MODULE

COVER

ORD. NO.

F BL 9384 00 08



1 MODULE

SOCKET 380V 3P+N+T

ORD. NO.

WIRING

F BL 9395 51 00	YES
F BL 9395 52 00	NO

Made up of: 1 socket 380V 16A 3P+N+T

Protection rating IP40



1 MODULE

SOCKET 220V 2P+T

ORD. NO.

WIRING

F BL 9395 55 00	YES
F BL 9395 56 00	NO

Made up of: 1 socket 220V CEE 16A 2P+T

Protection rating IP40



PNEUMATIC SUPPLY HOSE

ORD. NO.

F BL 9401 02 00

The 3 metres long cable is supplied complete with
1 coupling, 2 male hose fittings with bands,
1 cap. Connectors 3/8"



1 MODULE

SOCKET 380V 3P+T

ORD. NO.

WIRING

F BL 9395 53 00	YES
F BL 9395 54 00	NO

Made up of: 1 socket 380V 16A 3P+T

Protection rating IP40



ACCESSORIES

ACCESSORIES FOR SLICK / COMFORT / DYNAMIC

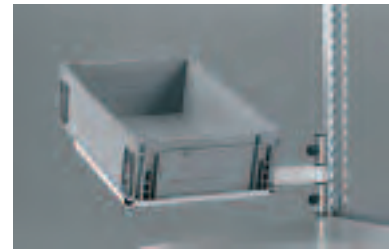
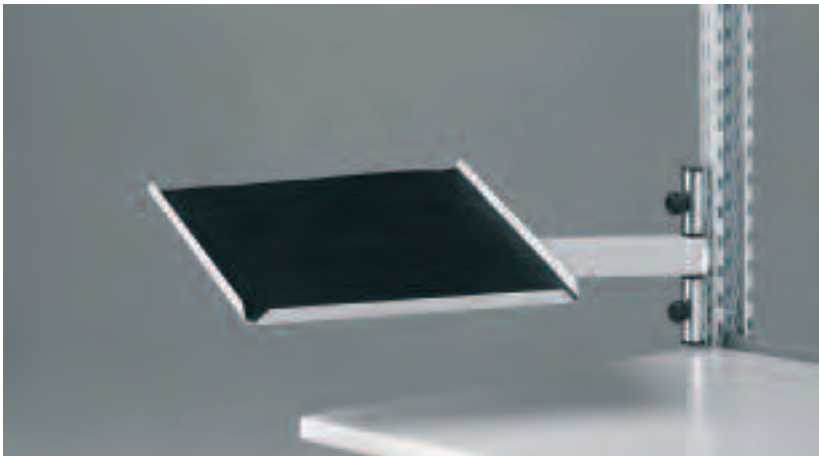

SWIVEL ARM WITH TWO JOINTS AND TILTED TRAY
ORD. NO.

F BL 7456 00 08

Complete with screw brakes with knob

Internal dim. of tray 401x402x21 mm h. Load capacity 20 kg

Colours available: ■ 01 ■ 02 ■ 04 ■ 08



SWIVEL ARM WITH TWO JOINTS WITH CONTAINERS
ORD. NO.

F BL 7445 03 08

Complete with 5 containers size 1 grey and
3 containers size 2 grey

Load capacity 15 kg

Colours available: ■ 01 ■ 02 ■ 04 ■ 08



SWIVEL ARM WITH TWO JOINTS WITH CONTAINERS
ORD. NO.

F BL 7445 04 08

Complete with 15 containers size 1 grey

Load capacity 15 kg

Colours available: ■ 01 ■ 02 ■ 04 ■ 08



SWIVEL ARM WITH TWO JOINTS AND TRAY
ORD. NO.

F BL 7455 00 08

Complete with screw brakes with knob

Load capacity 20 kg

Colours available: ■ 01 ■ 02 ■ 04 ■ 08



SWIVEL ARM WITH TWO JOINTS AND PRACTIBOX
ORD. NO.

F BL 7446 01 08

Complete with 1 practibox with 9 drawers and 2 practibox
with 6 drawers. **Load capacity 15 kg**

Colours available: ■ 01 ■ 02 ■ 04 ■ 08

RAL 7000 F.01 RAL 6011 F.02 RAL 5012 F.04 RAL 7035 F.08

KEY ■

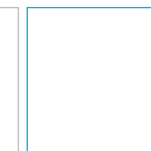
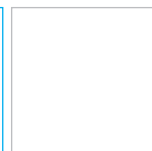
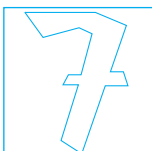

■ All indicated loads are net and refer to evenly distributed weights



ACCESSORIES FOR SLICK / COMFORT / DYNAMIC

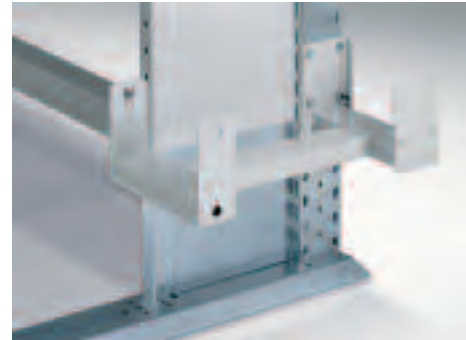

COMPUTER HOLDING FRAME

ORD. NO.

F BL 7444 00 08

For Tower versions only

Dim. 223x416x134 mm h. Usable dimensions 210x412 mm h

Colours available: ■ 01 ■ 02 ■ 04 ■ 08

ACCESSORIES FOR SLICK / COMFORT / DYNAMIC

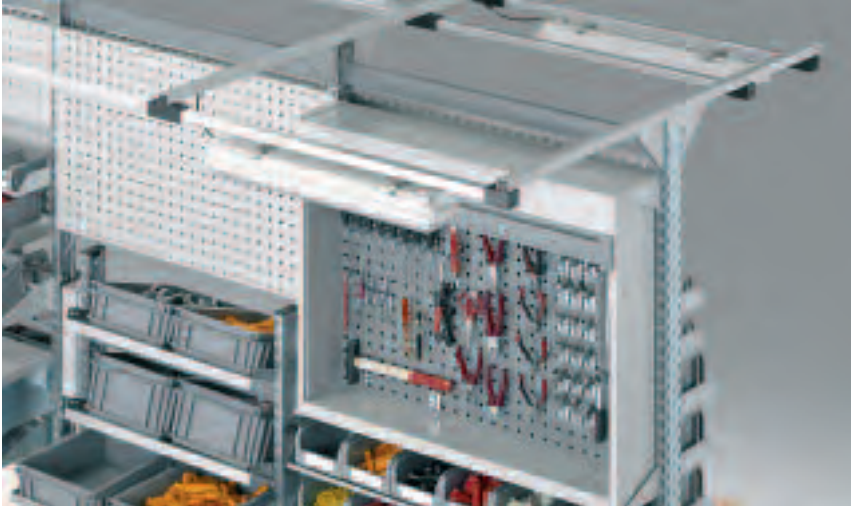

ROLLER CABINET

ORD. NO.

F BL 7011 02 01

To fix to dual slot uprights

Overall dim.: 952x210x810 mm h. Usable dim.: 905x150x581 mm. Load capacity 10 kg

Colours available:

■ 01 ■ 02 ■ 51 ■ 56

■ **INFO**

RAL 7000 F.01 RAL 6011 F.02 RAL 5012 F.04 RAL 7035 F.08

■ Hooks see page C66

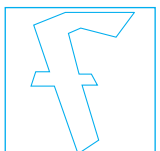
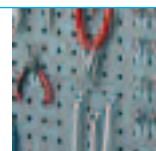

www.famispa.com

ORGANIZE SPACE

LET'S REORG

- **MODULAR TROLLEYS SERIES COMBI**

SEVERAL WHEELS TYPES

STRONG AND RELIABLE THROUGH TIME

VERSATILE

SUITABLE FOR MATERIALS HANDLING AND STORAGE



ORGANIZE SPACE

LET'S REORG

SERIES COMBI

COMBI

STANDARD RUBBER WHEELS

**ORD. NO. C RG DAC11 100**

Ø 100 mm

C 130 mm

SWIVEL WHEEL WITH BRAKE

KIND OF TROLLEY	COMBI CE	COMBI CF1	COMBI CF2	COMBI CL1	COMBI CL2	COMBI CI	COMBI CK	COMBI CG	COMBI CH	COMBI CP1	COMBI CR 0091/0071/0031	COMBI CR 0021
LOAD CAPACITY KG	-	175	175	175	175	-	-	-	-	150	150	-

**ORD. NO. C RG CAC11 100**

Ø 100 mm

C 130 mm

SWIVEL WHEEL WITHOUT BRAKE

KIND OF TROLLEY	COMBI CE	COMBI CF1	COMBI CF2	COMBI CL1	COMBI CL2	COMBI CI	COMBI CK	COMBI CG	COMBI CH	COMBI CP1	COMBI CR 0091/0071/0031	COMBI CR 0021
LOAD CAPACITY KG	-	175	175	175	175	-	-	-	-	150	150	-

**ORD. NO. C RG DAC12 125**

Ø 125 mm

C 160 mm

SWIVEL WHEEL WITH BRAKE

KIND OF TROLLEY	COMBI CE	COMBI CF1	COMBI CF2	COMBI CL1	COMBI CL2	COMBI CI	COMBI CK	COMBI CG	COMBI CH	COMBI CP1	COMBI CR 0091/0071/0031	COMBI CR 0021
LOAD CAPACITY KG	-	250	250	250	250	-	-	-	-	150	300	-

**ORD. NO. C RG CAC12 125**

Ø 125 mm

C 160 mm

SWIVEL WHEEL WITHOUT BRAKE

KIND OF TROLLEY	COMBI CE	COMBI CF1	COMBI CF2	COMBI CL1	COMBI CL2	COMBI CI	COMBI CK	COMBI CG	COMBI CH	COMBI CP1	COMBI CR 0091/0071/0031	COMBI CR 0021
LOAD CAPACITY KG	-	250	250	250	250	-	-	-	-	150	300	-

**ORD. NO. C RG DAC13 150**

Ø 150 mm

C 185 mm

SWIVEL WHEEL WITH BRAKE

KIND OF TROLLEY	COMBI CE	COMBI CF1	COMBI CF2	COMBI CL1	COMBI CL2	COMBI CI	COMBI CK	COMBI CG	COMBI CH	COMBI CP1	COMBI CR 0091/0071/0031	COMBI CR 0021
LOAD CAPACITY KG	-	250	250	250	250	-	-	-	-	150	300	-

**ORD. NO. C RG CAC13 150**

Ø 150 mm

C 185 mm

SWIVEL WHEEL WITHOUT BRAKE

KIND OF TROLLEY	COMBI CE	COMBI CF1	COMBI CF2	COMBI CL1	COMBI CL2	COMBI CI	COMBI CK	COMBI CG	COMBI CH	COMBI CP1	COMBI CR 0091/0071/0031	COMBI CR 0021
LOAD CAPACITY KG	-	250	250	250	250	-	-	-	-	150	300	-

**ORD. NO. C RG DAC15 200**

Ø 200 mm

C 242 mm

SWIVEL WHEEL WITH BRAKE

KIND OF TROLLEY	COMBI CE	COMBI CF1	COMBI CF2	COMBI CL1	COMBI CL2	COMBI CI	COMBI CK	COMBI CG	COMBI CH	COMBI CP1	COMBI CR 0091/0071/0031	COMBI CR 0021
LOAD CAPACITY KG	500	-	-	-	-	500	500	500	500	-	-	-

**ORD. NO. C RG CAC15 200**

Ø 200 mm

C 242 mm

SWIVEL WHEEL WITHOUT BRAKE

KIND OF TROLLEY	COMBI CE	COMBI CF1	COMBI CF2	COMBI CL1	COMBI CL2	COMBI CI	COMBI CK	COMBI CG	COMBI CH	COMBI CP1	COMBI CR 0091/0071/0031	COMBI CR 0021
LOAD CAPACITY KG	500	-	-	-	-	500	500	500	500	-	-	-

**ORD. NO. C RG FAC11 100**

Ø 100 mm

C 120 mm

SWIVEL WHEEL WITHOUT BRAKE

KIND OF TROLLEY	COMBI CE	COMBI CF1	COMBI CF2	COMBI CL1	COMBI CL2	COMBI CI	COMBI CK	COMBI CG	COMBI CH	COMBI CP1	COMBI CR 0091/0071/0031	COMBI CR 0021
LOAD CAPACITY KG	-	-	-	-	-	-	-	-	-	-	-	150

With screw M12x35

STANDARD RUBBER WHEELS

C		ORD. NO. C RG BAC11 100		Ø 100 mm	C 130 mm	FIXED WHEEL								
		KIND OF TROLLEY	COMBI CE	COMBI CF1	COMBI CF2	COMBI CL1	COMBI CL2	COMBI CI	COMBI CK	COMBI CG	COMBI CH	COMBI CP1	COMBI CR 0091/0071/0031	COMBI CR 0021
		LOAD CAPACITY KG	-	175	175	175	175	-	-	-	-	150	150	-

C		ORD. NO. C RG BAC12 125		Ø 125 mm	C 160 mm	FIXED WHEEL								
		KIND OF TROLLEY	COMBI CE	COMBI CF1	COMBI CF2	COMBI CL1	COMBI CL2	COMBI CI	COMBI CK	COMBI CG	COMBI CH	COMBI CP1	COMBI CR 0091/0071/0031	COMBI CR 0021
		LOAD CAPACITY KG	-	250	250	250	250	-	-	-	-	150	300	-

C		ORD. NO. C RG BAC13 150		Ø 150 mm	C 185 mm	FIXED WHEEL								
		KIND OF TROLLEY	COMBI CE	COMBI CF1	COMBI CF2	COMBI CL1	COMBI CL2	COMBI CI	COMBI CK	COMBI CG	COMBI CH	COMBI CP1	COMBI CR 0091/0071/0031	COMBI CR 0021
		LOAD CAPACITY KG	-	250	250	250	250	-	-	-	-	150	300	-

C		ORD. NO. C RG BAC15 200		Ø 200 mm	C 242 mm	FIXED WHEEL								
		KIND OF TROLLEY	COMBI CE	COMBI CF1	COMBI CF2	COMBI CL1	COMBI CL2	COMBI CI	COMBI CK	COMBI CG	COMBI CH	COMBI CP1	COMBI CR 0091/0071/0031	COMBI CR 0021
		LOAD CAPACITY KG	500	-	-	-	-	500	500	500	500	-	-	-

NO-SMEAR RUBBER WHEELS

C		ORD. NO. C RG DPH22 125		Ø 125 mm	C 160 mm	SWIVEL WHEEL WITH BRAKE								
		KIND OF TROLLEY	COMBI CE	COMBI CF1	COMBI CF2	COMBI CL1	COMBI CL2	COMBI CI	COMBI CK	COMBI CG	COMBI CH	COMBI CP1	COMBI CR 0091/0071/0031	COMBI CR 0021
		LOAD CAPACITY KG	-	250	250	250	250	-	-	-	-	150	300	-

D		ORD. NO. C RG DPH25 160		Ø 160 mm	C 204 mm	SWIVEL WHEEL WITH BRAKE								
		KIND OF TROLLEY	COMBI CE	COMBI CF1	COMBI CF2	COMBI CL1	COMBI CL2	COMBI CI	COMBI CK	COMBI CG	COMBI CH	COMBI CP1	COMBI CR 0091/0071/0031	COMBI CR 0021
		LOAD CAPACITY KG	500	-	-	-	-	500	500	500	500	-	-	-

C		ORD. NO. C RG BPH22 125		Ø 125 mm	C 160 mm	FIXED WHEEL								
		KIND OF TROLLEY	COMBI CE	COMBI CF1	COMBI CF2	COMBI CL1	COMBI CL2	COMBI CI	COMBI CK	COMBI CG	COMBI CH	COMBI CP1	COMBI CR 0091/0071/0031	COMBI CR 0021
		LOAD CAPACITY KG	-	250	250	250	250	-	-	-	-	150	300	-

D		ORD. NO. C RG BPH25 160		Ø 160 mm	C 204 mm	FIXED WHEEL								
		KIND OF TROLLEY	COMBI CE	COMBI CF1	COMBI CF2	COMBI CL1	COMBI CL2	COMBI CI	COMBI CK	COMBI CG	COMBI CH	COMBI CP1	COMBI CR 0091/0071/0031	COMBI CR 0021
		LOAD CAPACITY KG	500	-	-	-	-	500	500	500	500	-	-	-

COMBI

ELASTIC RUBBER WHEELS

	ORD. NO. C RG DCE15 125	Ø 125 mm					C 160 mm					SWIVEL WHEEL WITH BRAKE		
	KIND OF TROLLEY	COMBI CE	COMBI CF1	COMBI CF2	COMBI CL1	COMBI CL2	COMBI CI	COMBI CK	COMBI CG	COMBI CH	COMBI CP1	COMBI CR 0091/0071/0031	COMBI CR 0021	
	LOAD CAPACITY KG	-	250	250	250	250	-	-	-	-	150	300	-	

	ORD. NO. C RG DCE15 160	Ø 160 mm					C 204 mm					SWIVEL WHEEL WITH BRAKE		
	KIND OF TROLLEY	COMBI CE	COMBI CF1	COMBI CF2	COMBI CL1	COMBI CL2	COMBI CI	COMBI CK	COMBI CG	COMBI CH	COMBI CP1	COMBI CR 0091/0071/0031	COMBI CR 0021	
	LOAD CAPACITY KG	500	-	-	-	-	500	500	500	500	-	-	-	

	ORD. NO. C RG BCE15 125	Ø 125 mm					C 160 mm					FIXED WHEEL		
	KIND OF TROLLEY	COMBI CE	COMBI CF1	COMBI CF2	COMBI CL1	COMBI CL2	COMBI CI	COMBI CK	COMBI CG	COMBI CH	COMBI CP1	COMBI CR 0091/0071/0031	COMBI CR 0021	
	LOAD CAPACITY KG	-	250	250	250	250	-	-	-	-	150	300	-	

	ORD. NO. C RG BCE15 160	Ø 160 mm					C 204 mm					FIXED WHEEL		
	KIND OF TROLLEY	COMBI CE	COMBI CF1	COMBI CF2	COMBI CL1	COMBI CL2	COMBI CI	COMBI CK	COMBI CG	COMBI CH	COMBI CP1	COMBI CR 0091/0071/0031	COMBI CR 0021	
	LOAD CAPACITY KG	500	-	-	-	-	500	500	500	500	-	-	-	

INFLATABLE WHEELS

	ORD. NO. C RG CMH11 200	Ø 200 mm					C 238 mm					SWIVEL WHEEL WITHOUT BRAKE		
	KIND OF TROLLEY	COMBI CE	COMBI CF1	COMBI CF2	COMBI CL1	COMBI CL2	COMBI CI	COMBI CK	COMBI CG	COMBI CH	COMBI CP1	COMBI CR 0091/0071/0031	COMBI CR 0021	
	LOAD CAPACITY KG	170	-	-	-	-	170	170	170	170	-	-	-	

	ORD. NO. C RG BMH11 200	Ø 200 mm					C 238 mm					FIXED WHEEL		
	KIND OF TROLLEY	COMBI CE	COMBI CF1	COMBI CF2	COMBI CL1	COMBI CL2	COMBI CI	COMBI CK	COMBI CG	COMBI CH	COMBI CP1	COMBI CR 0091/0071/0031	COMBI CR 0021	
	LOAD CAPACITY KG	170	-	-	-	-	170	170	170	170	-	-	-	

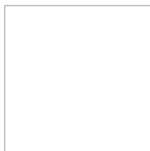
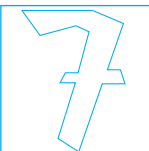

ORD. NO. C RN DAD10 100 \varnothing 100 mm C 130 mm **SWIVEL WHEEL WITH BRAKE**

KIND OF TROLLEY	COMBI CE	COMBI CF1	COMBI CF2	COMBI CL1	COMBI CL2	COMBI CI	COMBI CK	COMBI CG	COMBI CH	COMBI CP1	COMBI CR 0091/0071/0031	COMBI CR 0021
LOAD CAPACITY KG	-	250	250	250	250	-	-	-	-	150	300	-

ORD. NO. C RN DAD11 125 \varnothing 125 mm C 160 mm **SWIVEL WHEEL WITH BRAKE**

KIND OF TROLLEY	COMBI CE	COMBI CF1	COMBI CF2	COMBI CL1	COMBI CL2	COMBI CI	COMBI CK	COMBI CG	COMBI CH	COMBI CP1	COMBI CR 0091/0071/0031	COMBI CR 0021
LOAD CAPACITY KG	-	250	250	250	250	-	-	-	-	150	300	-

ORD. NO. C RN DAD04 160 \varnothing 160 mm C 204 mm **SWIVEL WHEEL WITH BRAKE**

KIND OF TROLLEY	COMBI CE	COMBI CF1	COMBI CF2	COMBI CL1	COMBI CL2	COMBI CI	COMBI CK	COMBI CG	COMBI CH	COMBI CP1	COMBI CR 0091/0071/0031	COMBI CR 0021
LOAD CAPACITY KG	500	-	-	-	-	500	500	500	500	-	-	-

ORD. NO. C RN BAD10 100 \varnothing 100 mm C 130 mm **FIXED WHEEL**

KIND OF TROLLEY	COMBI CE	COMBI CF1	COMBI CF2	COMBI CL1	COMBI CL2	COMBI CI	COMBI CK	COMBI CG	COMBI CH	COMBI CP1	COMBI CR 0091/0071/0031	COMBI CR 0021
LOAD CAPACITY KG	-	250	250	250	250	-	-	-	-	150	300	-

ORD. NO. C RN BAD11 125 \varnothing 125 mm C 160 mm **FIXED WHEEL**

KIND OF TROLLEY	COMBI CE	COMBI CF1	COMBI CF2	COMBI CL1	COMBI CL2	COMBI CI	COMBI CK	COMBI CG	COMBI CH	COMBI CP1	COMBI CR 0091/0071/0031	COMBI CR 0021
LOAD CAPACITY KG	-	250	250	250	250	-	-	-	-	150	300	-

ORD. NO. C RN BAD04 160 \varnothing 160 mm C 204 mm **FIXED WHEEL**

KIND OF TROLLEY	COMBI CE	COMBI CF1	COMBI CF2	COMBI CL1	COMBI CL2	COMBI CI	COMBI CK	COMBI CG	COMBI CH	COMBI CP1	COMBI CR 0091/0071/0031	COMBI CR 0021
LOAD CAPACITY KG	500	-	-	-	-	500	500	500	500	-	-	-



COMBI

POLYURETHANE WHEELS

ORD. NO. C RN DDD31 125 \varnothing 125 mm C 160 mm **SWIVEL WHEEL WITH BRAKE**

KIND OF TROLLEY	COMBI CE	COMBI CF1	COMBI CF2	COMBI CL1	COMBI CL2	COMBI CI	COMBI CK	COMBI CG	COMBI CH	COMBI CP1	COMBI CR 0091/0071/0031	COMBI CR 0021
LOAD CAPACITY KG	-	250	250	250	250	-	-	-	-	150	300	-

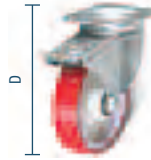
ORD. NO. C RN DDD44 160 \varnothing 160 mm C 204 mm **SWIVEL WHEEL WITH BRAKE**

KIND OF TROLLEY	COMBI CE	COMBI CF1	COMBI CF2	COMBI CL1	COMBI CL2	COMBI CI	COMBI CK	COMBI CG	COMBI CH	COMBI CP1	COMBI CR 0091/0071/0031	COMBI CR 0021
LOAD CAPACITY KG	500	-	-	-	-	500	500	500	500	-	-	-

ORD. NO. C RN BDD31 125 \varnothing 125 mm C 160 mm **FIXED WHEEL**

KIND OF TROLLEY	COMBI CE	COMBI CF1	COMBI CF2	COMBI CL1	COMBI CL2	COMBI CI	COMBI CK	COMBI CG	COMBI CH	COMBI CP1	COMBI CR 0091/0071/0031	COMBI CR 0021
LOAD CAPACITY KG	-	250	250	250	250	-	-	-	-	150	300	-

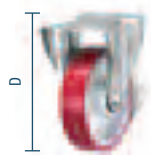
ORD. NO. C RN BDD44 160 \varnothing 160 mm C 204 mm **FIXED WHEEL**

KIND OF TROLLEY	COMBI CE	COMBI CF1	COMBI CF2	COMBI CL1	COMBI CL2	COMBI CI	COMBI CK	COMBI CG	COMBI CH	COMBI CP1	COMBI CR 0091/0071/0031	COMBI CR 0021
LOAD CAPACITY KG	500	-	-	-	-	500	500	500	500	-	-	-



CONDUCTIVE WHEELS

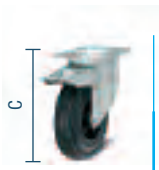

ORD. NO. C RG DDD11 100 \varnothing 100 mm C 130 mm **SWIVEL WHEEL WITH BRAKE**

KIND OF TROLLEY	COMBI CE	COMBI CF1	COMBI CF2	COMBI CL1	COMBI CL2	COMBI CI	COMBI CK	COMBI CG	COMBI CH	COMBI CP1	COMBI CR 0091/0071/0031	COMBI CR 0021
LOAD CAPACITY KG	-	160	160	160	160	-	-	-	-	150	160	-



ORD. NO. C RG CDD111 100 \varnothing 100 mm C 130 mm **SWIVEL WHEEL WITHOUT BRAKE**

KIND OF TROLLEY	COMBI CE	COMBI CF1	COMBI CF2	COMBI CL1	COMBI CL2	COMBI CI	COMBI CK	COMBI CG	COMBI CH	COMBI CP1	COMBI CR 0091/0071/0031	COMBI CR 0021
LOAD CAPACITY KG	-	160	160	160	160	-	-	-	-	150	160	-



ORD. NO. C RG CDD13 150 \varnothing 150 mm C 185 mm **SWIVEL WHEEL WITHOUT BRAKE**

KIND OF TROLLEY	COMBI CE	COMBI CF1	COMBI CF2	COMBI CL1	COMBI CL2	COMBI CI	COMBI CK	COMBI CG	COMBI CH	COMBI CP1	COMBI CR 0091/0071/0031	COMBI CR 0021
LOAD CAPACITY KG	-	250	250	250	250	-	-	-	-	150	300	-



ORD. NO. C RG RDD11 100 \varnothing 100 mm C 120 mm **SWIVEL WHEEL WITH BRAKE**

KIND OF TROLLEY	COMBI CE	COMBI CF1	COMBI CF2	COMBI CL1	COMBI CL2	COMBI CI	COMBI CK	COMBI CG	COMBI CH	COMBI CP1	COMBI CR 0091/0071/0031	COMBI CR 0021
LOAD CAPACITY KG	-	-	-	-	-	-	-	-	-	-	-	150

With screw M12x35

ORD. NO. C RG FDD11 100 \varnothing 100 mm C 120 mm **SWIVEL WHEEL WITHOUT BRAKE**

KIND OF TROLLEY	COMBI CE	COMBI CF1	COMBI CF2	COMBI CL1	COMBI CL2	COMBI CI	COMBI CK	COMBI CG	COMBI CH	COMBI CP1	COMBI CR 0091/0071/0031	COMBI CR 0021
LOAD CAPACITY KG	-	-	-	-	-	-	-	-	-	-	-	150



ORD. NO. C RG BDD11 100 \varnothing 100 mm C 130 mm **FIXED WHEEL**

KIND OF TROLLEY	COMBI CE	COMBI CF1	COMBI CF2	COMBI CL1	COMBI CL2	COMBI CI	COMBI CK	COMBI CG	COMBI CH	COMBI CP1	COMBI CR 0091/0071/0031	COMBI CR 0021
LOAD CAPACITY KG	-	175	175	175	175	-	-	-	-	150	150	-



ORD. NO. C RG BDD13 150 \varnothing 150 mm C 185 mm **FIXED WHEEL**

KIND OF TROLLEY	COMBI CE	COMBI CF1	COMBI CF2	COMBI CL1	COMBI CL2	COMBI CI	COMBI CK	COMBI CG	COMBI CH	COMBI CP1	COMBI CR 0091/0071/0031	COMBI CR 0021
LOAD CAPACITY KG	-	250	250	250	250	-	-	-	-	150	300	-



TROLLEYS SERIES COMBI CE

**DIN A4 DOCUMENT HOLDER**

ORD. NO.	DESCRIPTION
F CE 0980 00 99	DIN A4 horizontal wooden document holder
F CE 0985 00 99	DIN A4 vertical wooden document holder

SMOOTH RUBBER

ORD. NO.	DIM. mm	For mm wide trolleys
F CE 0595 00 07	1065x700	700
F CE 0600 00 07	1345x825	825

**STEEL RETAINERS**

ORD. NO.	DIM. mm	For mm wide trolleys
F CE 0925 00 04	663x38x100 h	700
F CE 0930 00 04	788x38x100 h	825



RAL 5012 F.04 RAL 6011 F.02

**KEY ■**

- The trolleys series COMBI CE are as standard supplied unassembled



WIDTH = 1135/1420 mm DEPTH = 700/825 mm HEIGHT (H) = 1000 mm

TROLLEYS SERIES COMBI CE



■ 04
■ 02

ORD. NO.

F CE B105 03 04

Trolley with 2 standard rubber swivel wheels **with** brakes and 2 standard rubber fixed wheels \varnothing 125 mm
Load capacity: 250 kg **Dim. mm 1135x700x915 h**



■ 04
■ 02



■ 04
■ 02

ORD. NO.

F CE P105 24 04

Trolley with 2 standard rubber swivel wheels **with** brakes and 2 standard rubber fixed wheels \varnothing 200 mm
Load capacity: 500 kg **Dim. mm 1095x715x1135 h**

ORD. NO.

F CE P105 23 04

Trolley with 2 standard rubber swivel wheels **with** brakes and 2 standard rubber fixed wheels \varnothing 200 mm
Load capacity: 500 kg **Dim. mm 1063x700x1080 h**



■ 04
■ 02



■ 04
■ 02

ORD. NO.

F CE P106 03 04

Trolley with 2 standard rubber swivel wheels **with** brakes and 2 standard rubber fixed wheels \varnothing 200 mm
Load capacity: 500 kg **Dim. mm 1135x700x1000 h**

ORD. NO.

F CE P105 03 04

Trolley with 2 standard rubber swivel wheels **with** brakes and 2 standard rubber fixed wheels \varnothing 200 mm
Load capacity: 500 kg **Dim. mm 1135x700x1000 h**

ORD. NO.

F CE P256 03 04

Trolley with 2 standard rubber swivel wheels **with** brakes and 2 standard rubber fixed wheels \varnothing 200 mm
Load capacity: 500 kg **Dim. mm 1420x825x1000 h**

ORD. NO.

F CE P255 03 04

Trolley with 2 standard rubber swivel wheels **with** brakes and 2 standard rubber fixed wheels \varnothing 200 mm
Load capacity: 500 kg **Dim. mm 1420x825x1000 h**

■ KEY

■ RAL 5012 F. 04 ■ RAL 6011 F. 02



■ All indicated loads are net and refer to evenly distributed weights



TROLLEYS SERIES COMBI CE

TROLLEYS WITH 2 STANDARD RUBBER SWIVEL WHEELS WITH BRAKES AND 2 STANDARD RUBBER FIXED WHEELS Ø 200 mm



■ 04
■ 02

ORD. NO.	DIM. mm
F CE P105 04 04	1135x700x1000 h
F CE P255 04 04	1420x825x1000 h

Load capacity: 500 kg



■ 04
■ 02

ORD. NO.	DIM. mm
F CE P105 12 04	1200x700x1000 h
F CE P255 12 04	1485x825x1000 h

Load capacity: 500 kg



■ 04
■ 02

ORD. NO.	DIM. mm
F CE P105 06 04	1200x700x1000 h
F CE P255 06 04	1485x825x1000 h

Load capacity: 500 kg

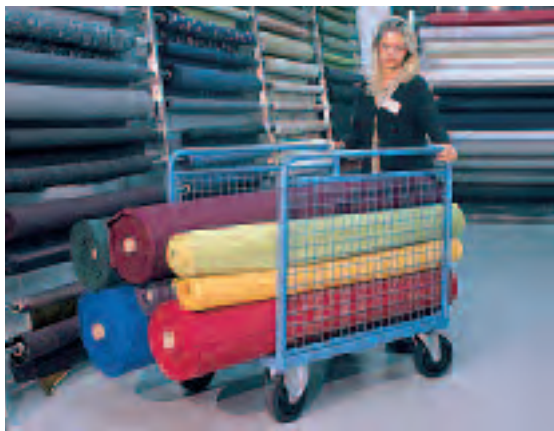

■ 04
■ 02

ORD. NO.	DIM. mm
F CE P105 22 04	1063x700x1080 h



■ 04
■ 02

ORD. NO.	DIM. mm
F CE P105 07 04	1200x700x1000 h
F CE P255 07 04	1485x825x1000 h

Load capacity: 500 kg

TROLLEYS WITH 2 STANDARD RUBBER SWIVEL WHEELS WITH BRAKES AND 2 STANDARD RUBBER FIXED WHEELS Ø 200 mm



■ 04
■ 02

ORD. NO.	DIM. mm
F CE P105 08 04	1135x700x1000 h
F CE P255 08 04	1420x825x1000 h

Load capacity: 500 kg



■ 04
■ 02

ORD. NO.	DIM. mm
F CE P105 15 04	1200x700x1000 h
F CE P255 15 04	1485x825x1000 h

Load capacity: 500 kg



■ 04
■ 02

ORD. NO.	DIM. mm
F CE P105 10 04	1200x700x1000 h
F CE P255 10 04	1485x825x1000 h

Load capacity: 500 kg

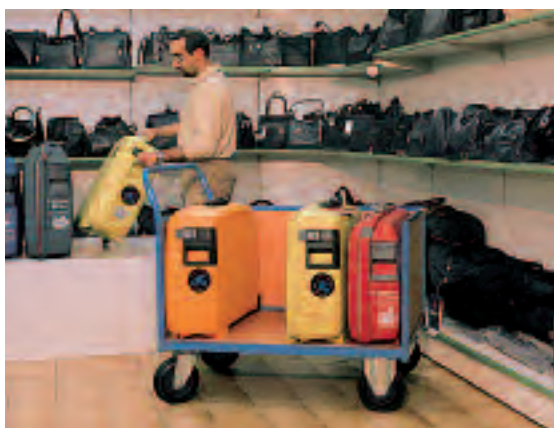

■ 04
■ 02

ORD. NO.	DIM. mm
F CE P106 10 04	1200x700x1000 h



■ 04
■ 02

ORD. NO.	DIM. mm
F CE P105 11 04	1200x700x1000 h
F CE P255 11 04	1485x825x1000 h

Load capacity: 500 kg

WIDTH = 1135/1420 mm DEPTH = 700/825 mm HEIGHT (H) = 1000 mm

TROLLEYS SERIES COMBI CE

TROLLEYS WITH 2 STANDARD RUBBER SWIVEL WHEELS WITH BRAKES AND 2 STANDARD RUBBER FIXED WHEELS Ø 200 mm



■ 04
■ 02

ORD. NO.	DIM. mm
F CE P105 20 04	1095x700x1000 h
F CE P255 20 04	1380x825x1000 h

Load capacity: 500 kg



■ 04
■ 02

ORD. NO.	DIM. mm
F CE P106 20 04	1095x700x1000 h
F CE P256 20 04	1380x825x1000 h

Load capacity: 500 kg



■ 04
■ 02

ORD. NO.	DIM. mm
F CE P105 21 04	1095x700x1000 h

Load capacity: 500 kg



■ 04
■ 02

ORD. NO.	DIM. mm
F CE P106 21 04	1095x700x1000 h

Load capacity: 500 kg

TROLLEYS WITH 2 STANDARD RUBBER SWIVEL WHEELS WITH BRAKES AND 2 STANDARD RUBBER FIXED WHEELS Ø 200 mm

ORD. NO.	DIMENSIONS mm
F CE P106 18 04	1135x700x1000 h



■ 04
■ 02

ORD. NO.	DIMENSIONS mm
F CE P105 08 04	1135x700x1000 h



■ KEY



■ All indicated loads are net and refer to evenly distributed weights

RAL 5012 F. 04 RAL 6011 F. 02



TROLLEYS SERIES COMBI CE

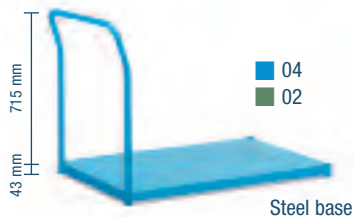

ORD. NO.	DIM. mm
F CE 0105 03 04	1135x700x758 h
Trolley suitable for wheels Ø 160–200 mm	



ORD. NO.	DIM. mm
F CE 0105 04 04	1135x700x758 h
F CE 0255 04 04	1420x825x758 h
Trolley suitable for wheels Ø 160–200 mm	



ORD. NO.	DIM. mm
F CE 0105 12 04	1200x700x758 h
F CE 0255 12 04	1485x825x758 h
Trolley suitable for wheels Ø 160–200 mm	

ORD. NO.	DIM. mm
F CE 0105 06 04	1200x700x758 h
F CE 0255 06 04	1485x825x758 h
Trolley suitable for wheels Ø 160–200 mm	



ORD. NO.	DIM. mm
F CE 0105 21 04	1095x700x758 h
Trolley suitable for wheels Ø 160–200 mm	



ORD. NO.	DIM. mm
F CE 0106 21 04	1095x700x758 h
Trolley suitable for wheels Ø 160–200 mm	



ORD. NO.	DIM. mm
F CE 0105 23 04	1063x700x838 h
Trolley suitable for wheels Ø 160–200 mm	

ORD. NO.	DIM. mm
F CE 0105 24 04	1095x715x893 h
Trolley suitable for wheels Ø 160–200 mm	



RAL 5012 F.04 RAL 6011 F.02

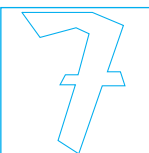

■ Wheels see page E2-E7

KEY ■

■ All indicated loads are net and refer to evenly distributed weights



WIDTH = 1135/1420 mm DEPTH = 700/825 mm HEIGHT (H) = 1000 mm

TROLLEYS SERIES COMBI CE



Steel base

ORD. NO.	DIM. mm
F CE 0105 20 04	1095x700x758 h
F CE 0255 20 04	1380x825x758 h

Trolley suitable for wheels Ø 160–200 mm



Wooden base

ORD. NO.	DIM. mm
F CE 0106 20 04	1095x700x758 h
F CE 0256 20 04	1380x825x758 h

Trolley suitable for wheels Ø 160–200 mm

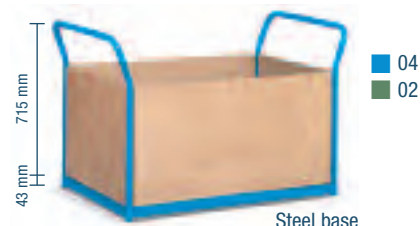

Steel base

ORD. NO.	DIM. mm
F CE 0105 11 04	1200x700x758 h
F CE 0255 11 04	1485x825x758 h

Trolley suitable for wheels Ø 160–200 mm

ORD. NO.	DIM. mm
F CE 0105 07 04	1200x700x758 h
F CE 0255 07 04	1485x825x758 h

Trolley suitable for wheels Ø 160–200 mm



Steel base



Wooden base

ORD. NO.	DIM. mm
F CE 0106 03 04	1135x700x758 h
F CE 0256 03 04	1420x825x758 h

Trolley suitable for wheels Ø 160–200 mm



Steel base

ORD. NO.	DIM. mm
F CE 0105 08 04	1135x700x758 h
F CE 0255 08 04	1420x825x758 h

Trolley suitable for wheels Ø 160–200 mm



Steel base

ORD. NO.	DIM. mm
F CE 0105 15 04	1200x700x758 h
F CE 0255 15 04	1485x825x758 h

Trolley suitable for wheels Ø 160–200 mm

ORD. NO.	DIM. mm
F CE 0105 10 04	1200x700x758 h
F CE 0255 10 04	1485x825x758 h

Trolley suitable for wheels Ø 160–200 mm



Steel base

KEY



All indicated loads are net and refer to evenly distributed weights

Wheels see page E2-E7

RAL 5012 F.04 RAL 6011 F.02



TROLLEYS SERIES COMBI CF1



RAL 5012 F.04

RAL 6011 F.02

INFO ■

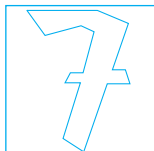

www.famispa.com



WIDTH = 945 mm DEPTH = 525 mm HEIGHT (H) = 1045 mm

TROLLEYS SERIES COMBI CF1

■ 04
■ 02



ORD. NO.

F CF H005 03 04

Trolley with 2 standard rubber swivel wheels **with** brakes and 2 standard rubber fixed wheels **Ø 150 mm**
Load capacity: 250 kg
Dimensions mm 945x525x1045 h

■ 04
■ 02



ORD. NO.

F CF H005 08 04

Trolley with 2 standard rubber swivel wheels **with** brakes and 2 standard rubber fixed wheels **Ø 150 mm**
Load capacity: 250 kg
Dimensions mm 945x525x1045 h

■ 04
■ 02



ORD. NO.

F CF H005 07 04

Trolley with 2 standard rubber swivel wheels **with** brakes and 2 standard rubber fixed wheels **Ø 150 mm**
Load capacity: 250 kg
Dimensions mm 945x525x1045 h

■ 04
■ 02



ORD. NO.

F CF H006 03 04

Trolley with 2 standard rubber swivel wheels **with** brakes and 2 standard rubber fixed wheels **Ø 150 mm**
Load capacity: 250 kg
Dimensions mm 945x525x1045 h

■ 04
■ 02



ORD. NO.

F CF H006 08 04

Trolley with 2 standard rubber swivel wheels **with** brakes and 2 standard rubber fixed wheels **Ø 150 mm**
Load capacity: 250 kg
Dimensions mm 945x525x1045 h

■ 04
■ 02



ORD. NO.

F CF H006 12 04

Trolley with 2 standard rubber swivel wheels **with** brakes and 2 standard rubber fixed wheels **Ø 150 mm**
Load capacity: 250 kg
Dimensions mm 945x525x1045 h

■ 04
■ 02



ORD. NO.

F CF H006 04 04

Trolley with 2 standard rubber swivel wheels **with** brakes and 2 standard rubber fixed wheels **Ø 150 mm**
Load capacity: 250 kg
Dimensions mm 945x525x1045 h

■ 04
■ 02



ORD. NO.

F CF H006 06 04

Trolley with 2 standard rubber swivel wheels **with** brakes and 2 standard rubber fixed wheels **Ø 150 mm**
Load capacity: 250 kg
Dimensions mm 945x525x1045 h

■ KEY



- Load capacity for shelves: 100 kg
- All indicated loads are net and refer to evenly distributed weights

RAL 5012 F. 04 RAL 6011 F. 02

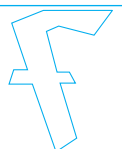

TROLLEYS SERIES COMBI CF1

SIDE FRAMES WITH AND WITHOUT HANDLE, BASES WITH WOODEN PLATE, BASES WITH STEEL PLATE

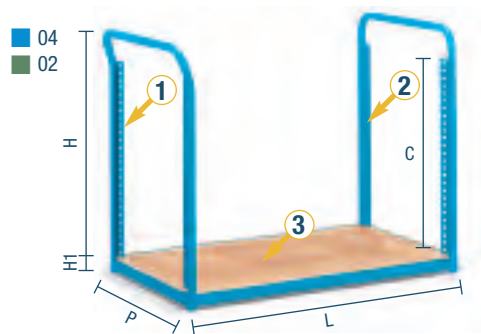

■ L	= 945 mm
■ P	= 525 mm
■ H	= 817 mm
■ H1	= 43 mm
■ C	= 685 mm

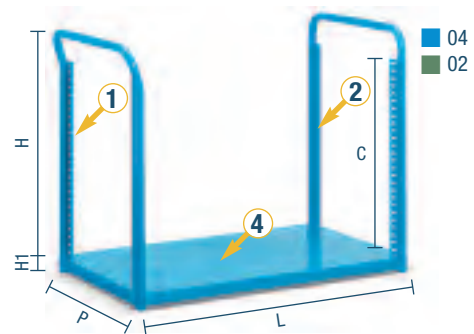

REFERENCE	ORD. NO. SIDE FRAME WITH HANDLE	DIM. mm
①	F CF 0605 00 04	521x70x870 h
REFERENCE	ORD. NO. BASE WITH WOODEN PLATE	DIM. mm
③	F CE G006 00 04	865x525x56 h

REFERENCE	ORD. NO. SIDE FRAME	DIM. mm
②	F CF 0615 00 04	521x30x875 h
REFERENCE	ORD. NO. BASE WITH STEEL PLATE	DIM. mm
④	F CE G005 00 04	865x525x56 h

ADDITIONAL STEEL SHELVES

ORD. NO.	LOAD CAPACITY kg	FOR TROLLEYS DIM. mm
F CF 0510 00 04	100	945x525

Dimensions mm 799x510x30 h



ORD. NO.

F CF 0590 00 07

Smooth rubber for trolleys. Dimensions mm 945x525

CONTAINER RETAINERS

ORD. NO.	SUITABLE FOR	FOR TROLLEYS DIM. mm
F CF 0900 00 99	Steel shelf	945x525
F CF 0901 00 99	Wooden shelf	945x525
F CF 0902 00 99	Steel and wooden bases	945x525

Dimensions mm 795x60

Order no. FCF 0902 00 99 can only be ordered with the base.



ADDITIONAL WOODEN SHELVES

ORD. NO.	LOAD CAPACITY kg	FOR TROLLEYS DIM. mm
F CF 0560 00 04	100	945x525

Dimensions mm 795x500x20 h



ADDITIONAL WOODEN TRAYS

ORD. NO.	LOAD CAPACITY kg	FOR TROLLEYS DIM. mm
F CF 0800 00 04	100	945x525

Dimensions mm 795x510x65 h. Internal dimensions mm 755x470x45 h



RAL 5012 F.04 RAL 6011 F.02

KEY

■ Wheels see page E2-E7

■ All indicated loads are net and refer to evenly distributed weights



WIDTH = 945 mm DEPTH = 525 mm HEIGHT (H) = 1045 mm

TROLLEYS SERIES COMBI CF1

MESHES FOR FRONTS

ORD. NO.	FOR TROLLEYS DIM. mm	MESH HOLE mm
F CF 0625 00 04	945x525	50x100

Dimensions mm 384x680

Single item delivered with 4 clamps



■ 04
■ 02

MESHES FOR SIDES

ORD. NO.	FOR TROLLEYS DIM. mm	MESH HOLE mm
F CF 0700 00 04	945x525	50x100

Dimensions mm 800x680

Single item delivered with 4 clamps and bolts

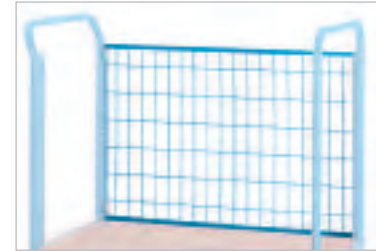

■ 04
■ 02



■ INFO



www.famispa.com

RAL 5012 F.04 RAL 6011 F.02

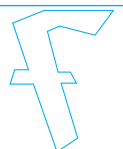

TROLLEYS SERIES COMBI CF2



RAL 5012 F.04 RAL 6011 F.02

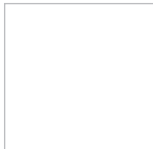
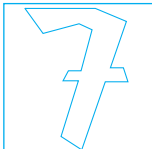

INFO ■

www.famispa.com



WIDTH = 1135 mm DEPTH = 625 mm HEIGHT (H) = 1045 mm

TROLLEYS SERIES COMBI CF2

■ 04
■ 02



ORD. NO.

F CF H055 03 04

Trolley with 2 standard rubber swivel wheels **with** brakes and 2 standard rubber fixed wheels Ø 150 mm
Load capacity: 250 kg
Dimensions mm 1135x625x1045 h

■ 04
■ 02



ORD. NO.

F CF H055 08 04

Trolley with 2 standard rubber swivel wheels **with** brakes and 2 standard rubber fixed wheels Ø 150 mm
Load capacity: 250 kg
Dimensions mm 1135x625x1045 h

■ 04
■ 02



ORD. NO.

F CF H055 07 04

Trolley with 2 standard rubber swivel wheels **with** brakes and 2 standard rubber fixed wheels Ø 150 mm
Load capacity: 250 kg
Dimensions mm 1135x625x1045 h

■ 04
■ 02



ORD. NO.

F CF H056 03 04

Trolley with 2 standard rubber swivel wheels **with** brakes and 2 standard rubber fixed wheels Ø 150 mm
Load capacity: 250 kg
Dimensions mm 1135x625x1045 h

■ 04
■ 02



ORD. NO.

F CF H056 08 04

Trolley with 2 standard rubber swivel wheels **with** brakes and 2 standard rubber fixed wheels Ø 150 mm
Load capacity: 250 kg
Dimensions mm 1135x625x1045 h

■ 04
■ 02



ORD. NO.

F CF H056 12 04

Trolley with 2 standard rubber swivel wheels **with** brakes and 2 standard rubber fixed wheels Ø 150 mm
Load capacity: 250 kg
Dimensions mm 1135x625x1045 h

■ 04
■ 02



ORD. NO.

F CF H056 04 04

Trolley with 2 standard rubber swivel wheels **with** brakes and 2 standard rubber fixed wheels Ø 150 mm
Load capacity: 250 kg
Dimensions mm 1135x625x1045 h

■ 04
■ 02



ORD. NO.

F CF H056 06 04

Trolley with 2 standard rubber swivel wheels **with** brakes and 2 standard rubber fixed wheels Ø 150 mm
Load capacity: 250 kg
Dimensions mm 1135x625x1045 h

■ KEY



- Shelves load capacity: 100 kg
- All indicated loads are net and refer to evenly distributed weights

RAL 5012 F. 04 RAL 6011 F. 02

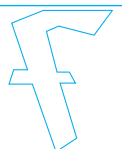

TROLLEYS SERIES COMBI CF2

SIDE FRAMES WITH AND WITHOUT HANDLE, BASES WITH WOODEN PLATE, BASES WITH STEEL PLATE

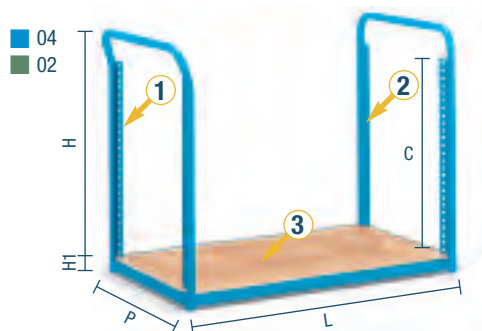

- L = 1135 mm
- P = 625 mm
- H = 817 mm
- H1 = 43 mm
- C = 685 mm

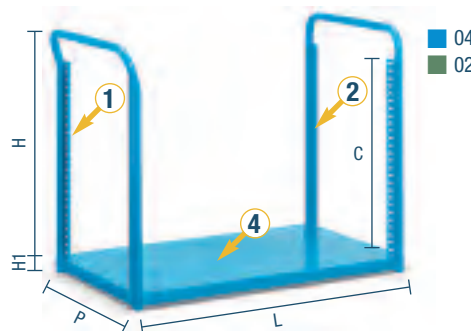

REFERENCE	ORD. NO. SIDE FRAME WITH HANDLE	DIM. mm
1	F CF 0610 00 04	621x70x870 h

REFERENCE	ORD. NO. SIDE FRAME	DIM. mm
2	F CF 0620 00 04	621x30x875 h

REFERENCE	ORD. NO. BASE WITH WOODEN PLATE	DIM. mm
3	F CE G056 00 04	1065x625x56 h

REFERENCE	ORD. NO. BASE WITH STEEL PLATE	DIM. mm
4	F CE G055 00 04	1065x625x56 h

ADDITIONAL STEEL SHELVES

ORD. NO.	LOAD CAPACITY kg	FOR TROLLEYS DIM. mm
F CF 0530 00 04	100	1135x625

Dimensions mm 999x610x30 h



ORD. NO.

F CF 0600 00 07

Smooth rubber for trolleys. Dimensions mm 1135x625

CONTAINER RETAINERS

ORD. NO.	SUITABLE FOR	FOR TROLLEYS DIM. mm
F CF 0905 00 99	Steel shelf	1135x625
F CF 0906 00 99	Wooden shelf	1135x625
F CF 0907 00 99	Steel and wooden bases	1135x625

Dimensions mm 995x60



ADDITIONAL WOODEN SHELVES

ORD. NO.	LOAD CAPACITY kg	FOR TROLLEYS DIM. mm
F CF 0580 00 04	100	1135x625

Dimensions mm 995x600x20 h



ADDITIONAL WOODEN TRAYS

ORD. NO.	LOAD CAPACITY kg	FOR TROLLEYS DIM. mm
F CF 0810 00 04	100	1135x625

Dimensions mm 995x610x65 h. Internal dimensions mm 960x580x45 h



RAL 5012 F.04 RAL 6011 F.02

KEY

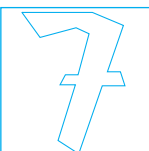

■ Wheels see page E2-E7

■ All indicated loads are net and refer to evenly distributed weights



WIDTH = 1135 mm DEPTH = 625 mm HEIGHT (H) = 1045 mm

TROLLEYS SERIES COMBI CF2

MESHES FOR FRONTS

ORD. NO.	FOR TROLLEYS DIM. mm	MESH HOLE mm
F CF 0630 00 04	1135x625	50x100

Dimensions mm 484x680

Single item delivered with 4 clamps



■ 04
■ 02

MESHES FOR SIDES

ORD. NO.	FOR TROLLEYS DIM. mm	MESH HOLE mm
F CF 0705 00 04	1135x625	50x100

Dimensions mm 1000x680

Single item delivered with 4 clamps and bolts

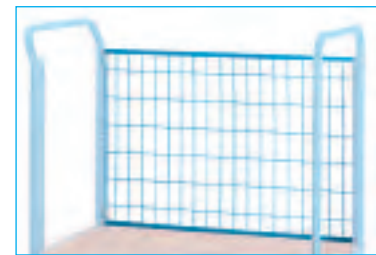

■ 04
■ 02

FORK LIFT BASE

ORD. NO.	DIMENSIONS mm
F CF 0965 00 04	238x615x70 h



■ 04
■ 02

■ INFO

RAL 5012 F.04 RAL 6011 F.02



www.famispa.com

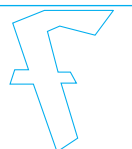

TROLLEYS SERIES COMBI CL1



RAL 5012 F.04 RAL 6011 F.02

INFO ■

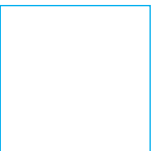
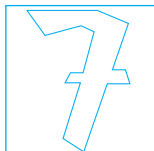

www.famispa.com



WIDTH = 945 mm DEPTH = 525 mm HEIGHT (H) = 1435 mm

TROLLEYS SERIES COMBI CL1

■ 04
■ 02



ORD. NO.

F CL H006 04 04

Trolley with 2 standard rubber swivel wheels **with** brakes and 2 standard rubber fixed wheels Ø 150 mm
Load capacity: 250 kg
Dimensions mm 945x525x1435 h

■ 04
■ 02



ORD. NO.

F CL H006 06 04

Trolley with 2 standard rubber swivel wheels **with** brakes and 2 standard rubber fixed wheels Ø 150 mm
Load capacity: 250 kg
Dimensions mm 945x525x1435 h

■ 04
■ 02



ORD. NO.

F CL H006 07 04

Trolley with 2 standard rubber swivel wheels **with** brakes and 2 standard rubber fixed wheels Ø 150 mm
Load capacity: 250 kg
Dimensions mm 945x525x1435 h

■ 04
■ 02



ORD. NO.

F CL H006 10 04

Trolley with 2 standard rubber swivel wheels **with** brakes and 2 standard rubber fixed wheels Ø 150 mm
Load capacity: 250 kg
Dimensions mm 945x525x1435 h

■ 04
■ 02



ORD. NO.

F CL H005 04 04

Trolley with 2 standard rubber swivel wheels **with** brakes and 2 standard rubber fixed wheels Ø 150 mm
Load capacity: 250 kg
Dimensions mm 945x525x1435 h

■ 04
■ 02



ORD. NO.

F CL H005 05 04

Trolley with 2 standard rubber swivel wheels **with** brakes and 2 standard rubber fixed wheels Ø 150 mm
Load capacity: 250 kg
Dimensions mm 945x525x1435 h

■ 04
■ 02



ORD. NO.

F CL H005 03 04

Trolley with 2 standard rubber swivel wheels **with** brakes and 2 standard rubber fixed wheels Ø 150 mm
Load capacity: 250 kg
Dimensions mm 945x545x1435 h

With removable mesh side

■ KEY

RAL 5012 F.04 RAL 6011 F.02



- Shelves load capacity: 100 kg
- All indicated loads are net and refer to evenly distributed weights



TROLLEYS SERIES COMBI CL1

SIDE FRAMES WITH AND WITHOUT HANDLE, BASES WITH WOODEN PLATE, BASES WITH STEEL PLATE

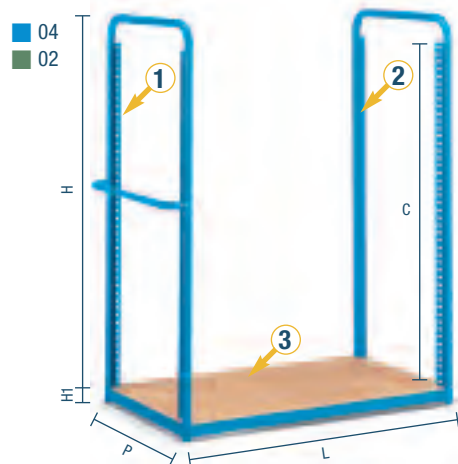

■ 04
■ 02

■ L = 945 mm
■ P = 525 mm
■ H = 1207 mm
■ H1 = 43 mm
■ C = 1100 mm

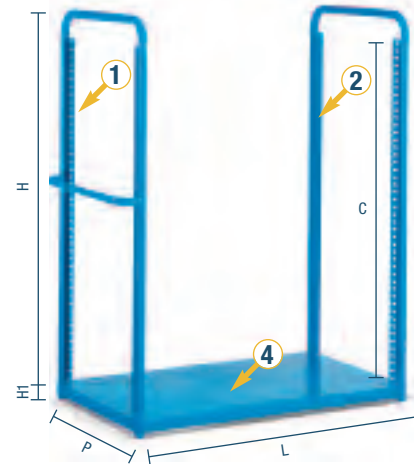

■ 04
■ 02

REFERENCE	ORD. NO. SIDE FRAME WITH HANDLE	DIM. mm
①	F CL 0605 00 04	521x105x1260 h

REFERENCE	ORD. NO. BASE WITH WOODEN PLATE	DIM. mm
③	F CE G006 00 04	865x525x56 h

REFERENCE	ORD. NO. SIDE FRAME	DIM. mm
②	F CL 0615 00 04	521x30x1260 h

REFERENCE	ORD. NO. BASE WITH STEEL PLATE	DIM. mm
④	F CE G005 00 04	865x525x56 h

ADDITIONAL STEEL SHELVES

ORD. NO.	LOAD CAPACITY kg	FOR TROLLEYS DIM. mm
F CF 0510 00 04	100	945x525

Dimensions mm 799x510x30 h



■ 04
■ 02

ORD. NO.

F CF 0590 00 07

Smooth rubber for trolleys. Dimensions mm 945x525

CONTAINER RETAINERS

ORD. NO.	SUITABLE FOR	FOR TROLLEYS DIM. mm
F CF 0900 00 99	Steel shelf	945x525
F CF 0901 00 99	Wooden shelf	945x525
F CF 0902 00 99	Steel and wooden bases	945x525

Dimensions mm 795x60

Order no. FCF 0902 00 99 can only be ordered with the base.



■ 99

ADDITIONAL WOODEN SHELVES

ORD. NO.	LOAD CAPACITY kg	FOR TROLLEYS DIM. mm
F CF 0560 00 04	100	945x525

Dimensions mm 795x500x20 h



■ 04
■ 02

ADDITIONAL WOODEN TRAYS

ORD. NO.	LOAD CAPACITY kg	FOR TROLLEYS DIM. mm
F CF 0800 00 04	100	945x525

Dimensions mm 795x510x65 h. Internal dimensions mm 795x510x65 h



■ 04
■ 02

RAL 5012 F.04

RAL 6011 F.02

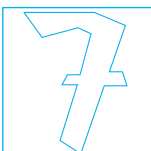

■ Wheels see page E2-E7

KEY ■

■ All indicated loads are net and refer to evenly distributed weights



WIDTH = 945 mm DEPTH = 525 mm HEIGHT (H) = 1435 mm

TROLLEYS SERIES COMBI CL1

MESHES FOR FRONTS

ORD. NO.	FOR TROLLEYS DIM. mm	MESH HOLE mm
F CL 0625 00 04	945x525	50x100

Dimensions mm 384x1095

Single item delivered with 4 clamps



■ 04
■ 02

MESHES FOR SIDES

ORD. NO.	FOR TROLLEYS DIM. mm	MESH HOLE mm
F CL 0700 00 04	945x525	50x100

Dimensions mm 800x1095

Two items delivered with 8 clamps and bolts



■ 04
■ 02



■ INFO

RAL 5012 F.04 RAL 6011 F.02



www.famispa.com

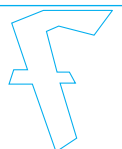

TROLLEYS SERIES COMBI CL2



RAL 5012 F.04 RAL 6011 F.02

INFO ■

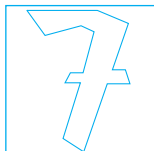

www.famispa.com



WIDTH = 1135 mm DEPTH = 625 mm HEIGHT (H) = 1435 mm

TROLLEYS SERIES COMBI CL2

04
02



ORD. NO.

F CL H056 04 04

Trolley with 2 standard rubber swivel wheels **with** brakes and 2 standard rubber fixed wheels **Ø 150 mm**
Load capacity: 250 kg
Dimensions mm 1135x625x1535 h

04
02



ORD. NO.

F CL H056 06 04

Trolley with 2 standard rubber swivel wheels **with** brakes and 2 standard rubber fixed wheels **Ø 150 mm**
Load capacity: 250 kg
Dimensions mm 1135x625x1535 h

04
02



ORD. NO.

F CL H056 07 04

Trolley with 2 standard rubber swivel wheels **with** brakes and 2 standard rubber fixed wheels **Ø 150 mm**
Load capacity: 250 kg
Dimensions mm 1135x625x1535 h

04
02



ORD. NO.

F CL H056 10 04

Trolley with 2 standard rubber swivel wheels **with** brakes and 2 standard rubber fixed wheels **Ø 150 mm**
Load capacity: 250 kg
Dimensions mm 1135x625x1535 h

04
02



ORD. NO.

F CL H055 04 04

Trolley with 2 standard rubber swivel wheels **with** brakes and 2 standard rubber fixed wheels **Ø 150 mm**
Load capacity: 250 kg
Dimensions mm 1135x625x1535 h

04
02



ORD. NO.

F CL H055 05 04

Trolley with 2 standard rubber swivel wheels **with** brakes and 2 standard rubber fixed wheels **Ø 150 mm**
Load capacity: 250 kg
Dimensions mm 1135x625x1535 h

04
02



With removable mesh side

ORD. NO.

F CL H055 03 04

Trolley with 2 standard rubber swivel wheels **with** brakes and 2 standard rubber fixed wheels **Ø 150 mm**
Load capacity: 250 kg
Dimensions mm 1135x645x1535 h

KEY



- Shelves load capacity: 100 kg
- All indicated loads are net and refer to evenly distributed weights

RAL 5012 F.04 RAL 6011 F.02



TROLLEYS SERIES COMBI CL2

SIDE FRAMES WITH AND WITHOUT HANDLE, BASES WITH WOODEN PLATE, BASES WITH STEEL PLATE

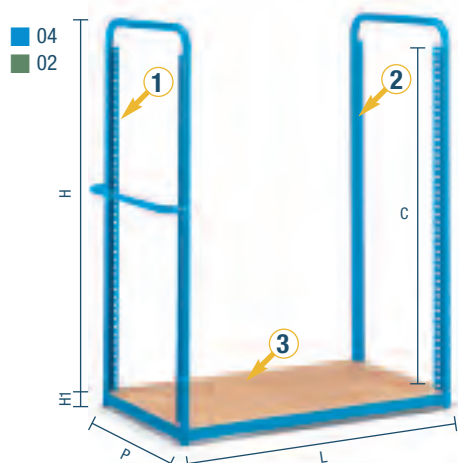

- L = 1135 mm
- P = 625 mm
- H = 1307 mm
- H1 = 43 mm
- C = 1200 mm

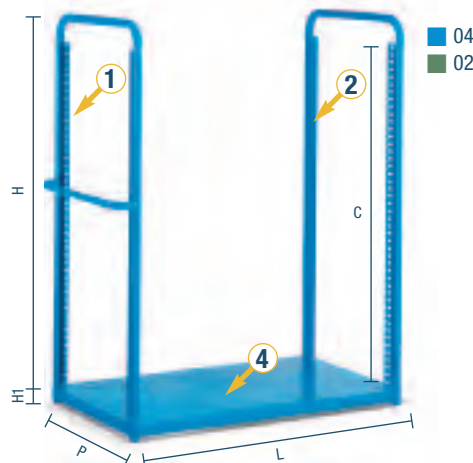

REFERENCE	ORD. NO. SIDE FRAME WITH HANDLE	DIM. mm
①	F CL 0610 00 04	621x105x1360 h

REFERENCE	ORD. NO. BASE WITH WOODEN PLATE	DIM. mm
③	F CE G056 00 04	1065x625x56 h

REFERENCE	ORD. NO. SIDE FRAME	DIM. mm
②	F CL 0620 00 04	621x30x1360 h

REFERENCE	ORD. NO. BASE WITH STEEL PLATE	DIM. mm
④	F CE G055 00 04	1065x625x56 h

ADDITIONAL STEEL SHELVES

ORD. NO.	LOAD CAPACITY kg	FOR TROLLEYS DIM. mm
F CF 0530 00 04	100	1135x625

Dimensions mm 999x610x30 h



ORD. NO.

F CF 0600 00 07

Smooth rubber for trolleys. Dimensions mm 1135x625

CONTAINER RETAINERS

ORD. NO.	SUITABLE FOR	FOR TROLLEYS DIM. mm
F CF 0905 00 99	Steel shelf	1135x625
F CF 0906 00 99	Wooden shelf	1135x625
F CF 0907 00 99	Steel and wooden bases	1135x625

Dimensions mm 995x60



ADDITIONAL WOODEN SHELVES

ORD. NO.	LOAD CAPACITY kg	FOR TROLLEYS DIM. mm
F CF 0580 00 04	100	1135x625

Dimensions mm 995x600x20 h



ADDITIONAL WOODEN TRAYS

ORD. NO.	LOAD CAPACITY kg	FOR TROLLEYS DIM. mm
F CF 0810 00 04	100	1135x625

Dimensions mm 995x610x65 h. Internal dimensions mm 960x580x45 h



RAL 5012 F.04 RAL 6011 F.02

KEY ■

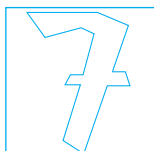

■ Wheels see page E2-E7

■ All indicated loads are net and refer to evenly distributed weights



WIDTH = 1135 mm DEPTH = 625 mm HEIGHT (H) = 1435 mm

TROLLEYS SERIES COMBI CL2

MESHES FOR FRONTS

ORD. NO.	FOR TROLLEYS DIM. mm	MESH HOLE mm
F CL 0630 00 04	1135x625	50x100
Dimensions mm 484x1200		
Single item delivered with 4 clamps		



■ 04
■ 02

MESHES FOR SIDES

ORD. NO.	FOR TROLLEYS DIM. mm	MESH HOLE mm
F CL 0705 00 04	1135x625	50x100
Dimensions mm 1000x1200		
Two items delivered with 8 clamps and bolts		



■ 04
■ 02

FORK LIFT BASE

ORD. NO.	DIMENSIONS mm
F CF 0965 00 04	238x615x70 h



■ 04
■ 02



■ INFO

RAL 5012 F.04 RAL 6011 F.02



www.famispa.com



TROLLEYS SERIES COMBI CI



RAL 5012 F.04

RAL 6011 F.02

INFO ■

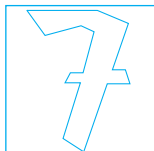

www.famispa.com



WIDTH = 1424 mm DEPTH = 825 mm HEIGHT (H) = 1200 mm

TROLLEYS SERIES COMBI CI



With removable mesh side

■ 04
■ 02

ORD. NO.

F CI P255 04 04

Trolley with 2 standard rubber swivel wheels **with** brakes and 2 standard rubber fixed wheels **Ø 200 mm**
Load capacity: 500 kg

Dimensions mm 1425x845x1200 h



With removable mesh side

■ 04
■ 02

ORD. NO.

F CI P256 04 04

Trolley with 2 standard rubber swivel wheels **with** brakes and 2 standard rubber fixed wheels **Ø 200 mm**
Load capacity: 500 kg

Dimensions mm 1425x845x1200 h



■ 04
■ 02

ORD. NO.

F CI P256 06 04

Trolley with 2 standard rubber swivel wheels **with** brakes and 2 standard rubber fixed wheels **Ø 200 mm**
Load capacity: 500 kg

Dimensions mm 1425x825x1200 h



■ 04
■ 02

ORD. NO.

F CI P256 03 04

Trolley with 2 standard rubber swivel wheels **with** brakes and 2 standard rubber fixed wheels **Ø 200 mm**
Load capacity: 500 kg

Dimensions mm 1425x825x1200 h



■ 04
■ 02

ORD. NO.

F CI P256 05 04

Trolley with 2 standard rubber swivel wheels **with** brakes and 2 standard rubber fixed wheels **Ø 200 mm**
Load capacity: 500 kg

Dimensions mm 1425x825x1200 h



■ 04
■ 02

ORD. NO.

F CI P255 03 04

Trolley with 2 standard rubber swivel wheels **with** brakes and 2 standard rubber fixed wheels **Ø 200 mm**
Load capacity: 500 kg

Dimensions mm 1425x825x1200 h



■ 04
■ 02

ORD. NO.

F CI P255 05 04

Trolley with 2 standard rubber swivel wheels **with** brakes and 2 standard rubber fixed wheels **Ø 200 mm**
Load capacity: 500 kg

Dimensions mm 1425x825x1200 h



■ 04
■ 02

ORD. NO.

F CI P255 06 04

Trolley with 2 standard rubber swivel wheels **with** brakes and 2 standard rubber fixed wheels **Ø 200 mm**
Load capacity: 500 kg

Dimensions mm 1425x825x1200 h

■ KEY



- Shelves load capacity: 100 kg
- All indicated loads are net and refer to evenly distributed weights

RAL 5012 F. 04 RAL 6011 F. 02

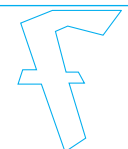

TROLLEYS SERIES COMBI CI

SIDE FRAMES WITH AND WITHOUT HANDLE, BASES WITH WOODEN PLATE, BASES WITH STEEL PLATE

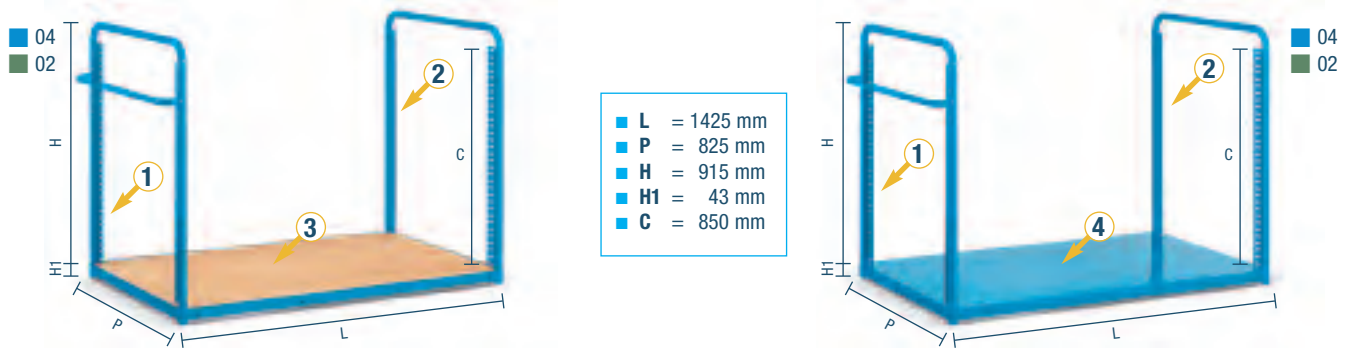

REFERENCE	ORD. NO. SIDE FRAME WITH HANDLE	DIM. mm
1	F CI 0605 00 04	821x105x970 h
REFERENCE	ORD. NO. BASE WITH WOODEN PLATE	DIM. mm
3	F CE N256 00 04	1345x825x56 h

REFERENCE	ORD. NO. SIDE FRAME	DIM. mm
2	F CI 0615 00 04	821x30x970 h
REFERENCE	ORD. NO. BASE WITH STEEL PLATE	DIM. mm
4	F CE N255 00 04	1345x825x56 h

ADDITIONAL WOODEN SHELVES

ORD. NO.	LOAD CAPACITY kg	FOR TROLLEYS DIM. mm
F CI 0560 00 04	100	1425x825

Dimensions mm 1280x800x20 h



CONTAINER RETAINERS

ORD. NO.	SUITABLE FOR	FOR TROLLEYS DIM. mm
F CG 0911 00 99	Wooden plate	1425x825
F CG 0912 00 99	Steel and wooden plates	1425x825

Dimensions mm 1275x60

Order no. FCG 0912 00 99 can only be ordered with the base.



FORK LIFT BASE

ORD. NO.	DIMENSIONS mm
F CI 0960 00 04	238x815x70 h



RAL 5012 F.04 RAL 6011 F.02

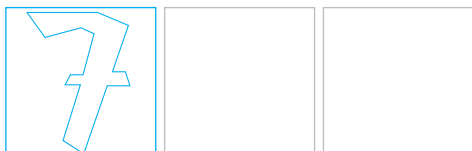

■ Wheels see page E2-E7

KEY ■

■ All indicated loads are net and refer to evenly distributed weights



WIDTH = 1424 mm DEPTH = 825 mm HEIGHT (H) = 1200 mm

TROLLEYS SERIES COMBI CI

MESHES FOR FRONTS

ORD. NO.	FOR TROLLEYS DIM. mm	MESH HOLE mm
F CI 0625 00 04	1425x825	100x100

Dimensions mm 684x810

Single item delivered with 4 clamps

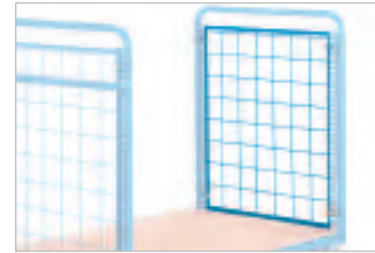

■ 04
■ 02

MESHES FOR SIDES

ORD. NO.	FOR TROLLEYS DIM. mm	MESH HOLE mm
F CI 0700 00 04	1425x825	100x100

Dimensions mm 1280x810

Single item delivered with 4 clamps and bolts

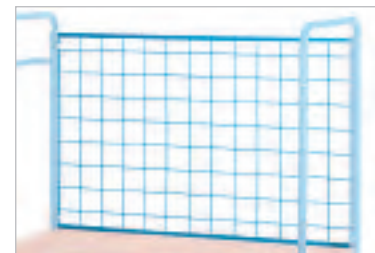

■ 04
■ 02



■ INFO

RAL 5012 F.04 RAL 6011 F.02



www.famispa.com

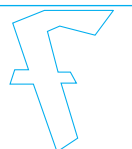

TROLLEYS SERIES COMBI CK



RAL 5012 F.04

RAL 6011 F.02

INFO ■

www.famispa.com

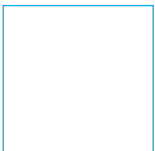
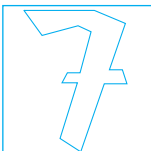

WIDTH = 1424 mm DEPTH = 825 mm HEIGHT (H) = 1800 mm

TROLLEYS SERIES COMBI CK



ORD. NO.

F CK P256 04 04

Trolley with 2 standard rubber swivel wheels **with** brakes and 2 standard rubber fixed wheels **Ø 200 mm**

Load capacity: 500 kg

Dimensions mm 1425x845x1800 h



ORD. NO.

F CK P255 04 04

Trolley with 2 standard rubber swivel wheels **with** brakes and 2 standard rubber fixed wheels **Ø 200 mm**

Load capacity: 500 kg

Dimensions mm 1425x845x1800 h



ORD. NO.

F CK P256 03 04

Trolley with 2 standard rubber swivel wheels **with** brakes and 2 standard rubber fixed wheels **Ø 200 mm**

Load capacity: 500 kg

Dimensions mm 1425x825x1800 h



ORD. NO.

F CK P256 06 04

Trolley with 2 standard rubber swivel wheels **with** brakes and 2 standard rubber fixed wheels **Ø 200 mm**

Load capacity: 500 kg

Dimensions mm 1425x825x1800 h



ORD. NO.

F CK P255 05 04

Trolley with 2 standard rubber swivel wheels **with** brakes and 2 standard rubber fixed wheels **Ø 200 mm**

Load capacity: 500 kg

Dimensions mm 1425x825x1800 h



ORD. NO.

F CK P255 07 04

Trolley with 2 standard rubber swivel wheels **with** brakes and 2 standard rubber fixed wheels **Ø 200 mm**

Load capacity: 500 kg

Dimensions mm 1425x825x1800 h

KEY



- Shelves load capacity: 100 kg
- All indicated loads are net and refer to evenly distributed weights

RAL 5012 F.04 RAL 6011 F.02

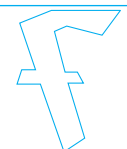

TROLLEYS SERIES COMBI CK

SIDE FRAMES WITH AND WITHOUT HANDLE, BASES WITH WOODEN PLATE, BASES WITH STEEL PLATE

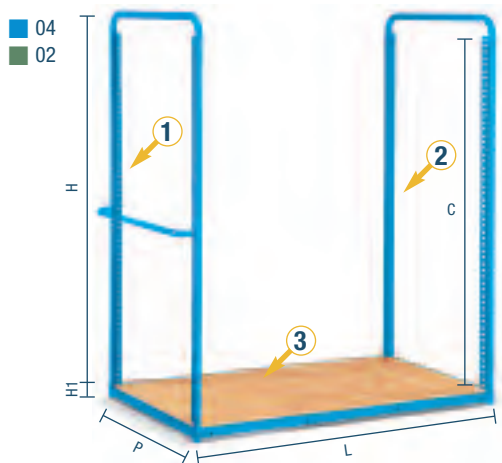

- L = 1425 mm
- P = 825 mm
- H = 1515 mm
- H1 = 43 mm
- C = 1435 mm

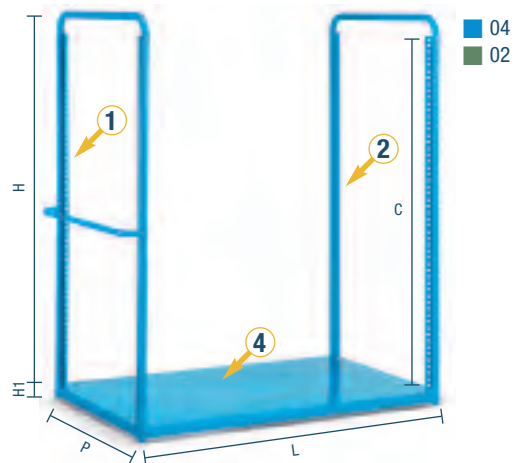

REFERENCE	ORD. NO. SIDE FRAME WITH HANDLE	DIM. mm
1	F CK 0605 00 04	821x105x1570 h

REFERENCE	ORD. NO. BASE WITH WOODEN PLATE	DIM. mm
3	F CE N256 00 04	1345x825x56 h

REFERENCE	ORD. NO. SIDE FRAME	DIM. mm
2	F CK 0615 00 04	821x30x1570 h

REFERENCE	ORD. NO. BASE WITH STEEL PLATE	DIM. mm
4	F CE N255 00 04	1345x825x56 h

ADDITIONAL WOODEN SHELVES

ORD. NO.	LOAD CAPACITY kg	FOR TROLLEYS DIM. mm
F CI 0560 00 04	100	1425x825

Dimensions mm 1280x800x20 h



CONTAINER RETAINERS

ORD. NO.	SUITABLE FOR	FOR TROLLEYS DIM. mm
F CG 0911 00 99	Wooden shelf	1425x825
F CG 0912 00 99	Steel and wooden bases	1425x825

Dimensions mm 1275x60

Order no. FCG 0912 00 99 can only be ordered with the base.



FORK LIFT BASE

ORD. NO.	DIMENSIONS mm
F CI 0960 00 04	238x815x70 h



RAL 5012 F.04 RAL 6011 F.02

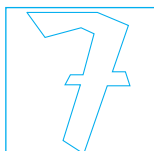

■ Wheels see page E2-E7

KEY ■

■ All indicated loads are net and refer to evenly distributed weights



WIDTH = 1424 mm DEPTH = 825 mm HEIGHT (H) = 1800 mm

TROLLEYS SERIES COMBI CK

MESHES FOR FRONTS

ORD. NO.	FOR TROLLEYS DIM. mm	MESH HOLE mm
F CK 0625 00 04	1425x825	100x100

Dimensions mm 684x1405

Single item delivered with 4 clamps

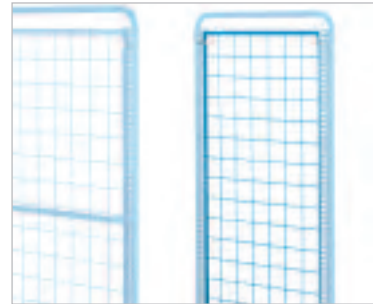

■ 04
■ 02

MESHES FOR SIDES

ORD. NO.	FOR TROLLEYS DIM. mm	MESH HOLE mm
F CK 0700 00 04	1425x825	100x100

Dimensions mm 1280x1405

Two items delivered with 8 clamps and bolts

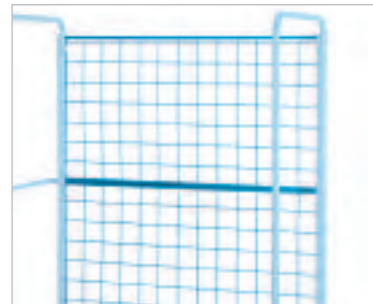

■ 04
■ 02



■ INFO



www.famispa.com

RAL 5012 F.04 RAL 6011 F.02

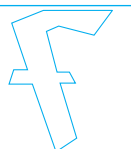

TROLLEYS SERIES COMBI CG



RAL 5012 F.04

RAL 6011 F.02

INFO ■

www.famispa.com

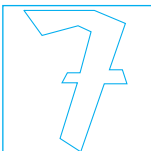

WIDTH = 1425 mm DEPTH = 525 mm HEIGHT (H) = 1490 mm

TROLLEYS SERIES COMBI CG



■ 04
■ 02

ORD. NO.

F CG P156 10 04

Trolley with 2 standard rubber swivel wheels **with** brakes and 2 standard rubber fixed wheels **Ø 200 mm**

Load capacity: 500 kg

Dimensions mm 1425x525x1490 h



■ 04
■ 02

ORD. NO.

F CG P155 05 04

Trolley with 2 standard rubber swivel wheels **with** brakes and 2 standard rubber fixed wheels **Ø 200 mm**

Load capacity: 500 kg

Dimensions mm 1425x525x1490 h



■ 04
■ 02

ORD. NO.

F CG P156 05 04

Trolley with 2 standard rubber swivel wheels **with** brakes and 2 standard rubber fixed wheels **Ø 200 mm**

Load capacity: 500 kg

Dimensions mm 1425x525x1490 h



■ 04
■ 02

ORD. NO.

F CG P155 07 04

Trolley with 2 standard rubber swivel wheels **with** brakes and 2 standard rubber fixed wheels **Ø 200 mm**

Load capacity: 500 kg

Dimensions mm 1425x525x1490 h



■ 04
■ 02

With 1 galvanized rear upstand

ORD. NO.

F CG P156 13 04

Trolley with 2 standard rubber swivel wheels **with** brakes and 2 standard rubber fixed wheels **Ø 200 mm**

Load capacity: 500 kg

Dim. mm 1425x525x1490 h Containers excluded

ORD. NO. **F CG P156 19 04**

Complete with 20 containers ord. no. F PM 6551 00 05



■ 04
■ 02

With 1 galvanized rear upstand

ORD. NO.

F CG P156 17 04

Trolley with 2 standard rubber swivel wheels **with** brakes and 2 standard rubber fixed wheels **Ø 200 mm**

Load capacity: 500 kg

Dim. mm 1425x525x1490 h Containers excluded

ORD. NO. **F CG P156 18 04**

Complete with 24 containers ord. no. F PM 5751 00 05



■ 04
■ 02

With removable mesh side

ORD. NO.

F CG P155 04 04

Trolley with 2 standard rubber swivel wheels **with** brakes and 2 standard rubber fixed wheels **Ø 200 mm**

Load capacity: 500 kg

Dimensions mm 1425x545x1490 h

■ KEY



- Shelves load capacity: 100 kg
- All indicated loads are net and refer to evenly distributed weights

■ RAL 5012 F. 04 ■ RAL 6011 F. 02



TROLLEYS SERIES COMBI CG

SIDE FRAMES WITH AND WITHOUT HANDLE, BASES WITH WOODEN PLATE, BASES WITH STEEL PLATE

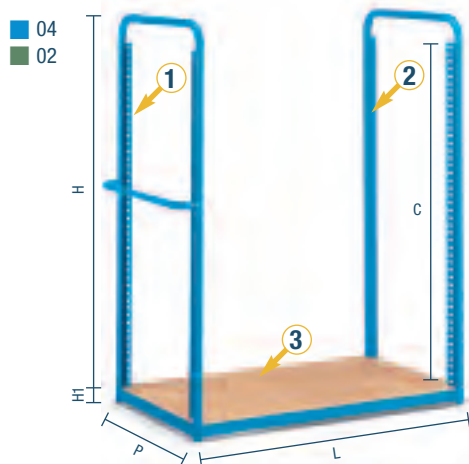

■ L	= 1425 mm
■ P	= 525 mm
■ H	= 1205 mm
■ H1	= 43 mm
■ C	= 1100 mm

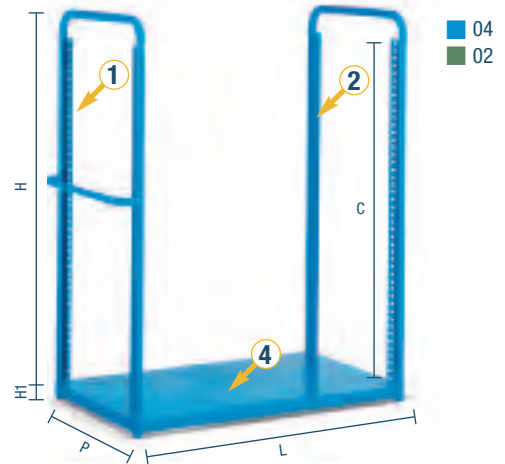

REFERENCE	ORD. NO. SIDE FRAME WITH HANDLE	DIM. mm
①	F CL 0605 00 04	521x105x1260 h
REFERENCE	ORD. NO. BASE WITH WOODEN PLATE	DIM. mm
③	F CE N156 00 04	1345x525x56 h

REFERENCE	ORD. NO. SIDE FRAME	DIM. mm
②	F CL 0615 00 04	521x30x1260 h
REFERENCE	ORD. NO. BASE WITH STEEL PLATE	DIM. mm
④	F CE N155 00 04	1345x525x56 h

ADDITIONAL STEEL SHELVES

ORD. NO.	LOAD CAPACITY kg	FOR TROLLEYS DIM. mm
F CG 0510 00 04	100	1425x525
Dimensions mm 1283x510x30 h		



ORD. NO.

F CG 0590 00 07

Smooth rubber for trolleys. Dimensions mm 1425x525

CONTAINER RETAINERS

ORD. NO.	SUITABLE FOR	FOR TROLLEYS DIM. mm
F CG 0910 00 99	Steel shelf	1425x525
F CG 0912 00 99	Steel and wooden bases	1425x525
Dimensions mm 1275x60		

Order no. FCG 0912 00 99 can only be ordered with the base.



ADDITIONAL WOODEN SHELVES

ORD. NO.	LOAD CAPACITY kg	FOR TROLLEYS DIM. mm
F CG 0560 00 04	100	1425x525
Dimensions mm 1260x500x12 h		



RAL 5012 F.04 RAL 6011 F.02

KEY ■

■ Wheels see page E2-E7

■ All indicated loads are net and refer to evenly distributed weights



WIDTH = 1425 mm DEPTH = 525 mm HEIGHT (H) = 1490 mm

TROLLEYS SERIES COMBI CG

MESHES FOR FRONTS

ORD. NO.	FOR TROLLEYS DIM. mm	MESH HOLE mm
F CL 0625 00 04	1425x525	50x100

Dimensions mm 384x1095

Single item delivered with 4 clamps



■ 04
■ 02

MESHES FOR SIDES

ORD. NO.	FOR TROLLEYS DIM. mm	MESH HOLE mm
F CG 0700 00 04	1425x525	50x100

Dimensions mm 1280x1095

Two items delivered with 8 clamps and bolts



■ 04
■ 02

FORK LIFT BASE

ORD. NO.	DIMENSIONS mm
F CF 0960 00 04	238x515x70 h



■ 04
■ 02



■ INFO

RAL 5012 F.04 RAL 6011 F.02



www.famispa.com



TROLLEYS SERIES COMBI CH



RAL 5012 F.04

RAL 6011 F.02

INFO ■

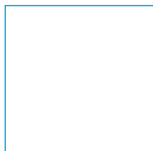
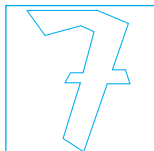

www.famispa.com



WIDTH = 1425 mm DEPTH = 625 mm HEIGHT (H) = 1590 mm

TROLLEYS SERIES COMBI CH



04
02

ORD. NO.

F CH P205 07 04

Trolley with 2 standard rubber swivel wheels **with** brakes and 2 standard rubber fixed wheels \varnothing 200 mm

Load capacity: 500 kg

Dimensions mm 1425x625x1590 h



04
02

ORD. NO.

F CH P206 11 04

Trolley with 2 standard rubber swivel wheels **with** brakes and 2 standard rubber fixed wheels \varnothing 200 mm

Load capacity: 500 kg

Dimensions mm 1425x625x1590 h



04
02

ORD. NO.

F CH P206 09 04

Trolley with 2 standard rubber swivel wheels **with** brakes and 2 standard rubber fixed wheels \varnothing 200 mm

Load capacity: 500 kg

Dimensions mm 1425x625x1590 h



04
02

ORD. NO.

F CH P205 05 04

Trolley with 2 standard rubber swivel wheels **with** brakes and 2 standard rubber fixed wheels \varnothing 200 mm

Load capacity: 500 kg

Dimensions mm 1425x625x1590 h



04
02

With 1 galvanised rear upstand

ORD. NO.

F CH P206 12 04

Trolley with 2 standard rubber swivel wheels **with** brakes and 2 standard rubber fixed wheels \varnothing 200 mm

Load capacity: 500 kg

Dim. mm 1425x625x1590 h Containers excluded

ORD. NO. **F CH P206 14 04**

Complete with 12 containers ord. no. F PA 6451 A0 01

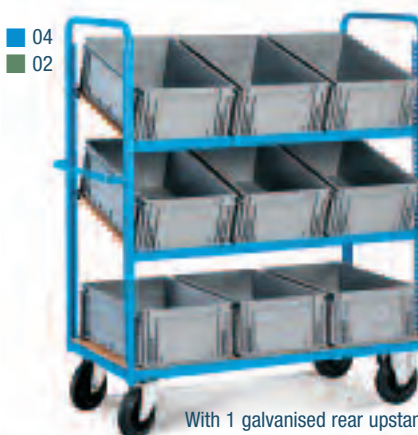

04
02

With 1 galvanised rear upstand

ORD. NO.

F CH P206 15 04

Trolley with 2 standard rubber swivel wheels **with** brakes and 2 standard rubber fixed wheels \varnothing 200 mm

Load capacity: 500 kg

Dim. mm 1425x625x1590 h Containers excluded

ORD. NO. **F CH P206 16 04**

Complete with 9 containers ord. no. F PA 6851 A0 01



04
02

With removable mesh side

ORD. NO.

F CH P205 04 04

Trolley with 2 standard rubber swivel wheels **with** brakes and 2 standard rubber fixed wheels \varnothing 200 mm

Load capacity: 500 kg

Dimensions mm 1425x645x1590 h

KEY



- Shelves load capacity: 100 kg
- All indicated loads are net and refer to evenly distributed weights

RAL 5012 F. 04 RAL 6011 F. 02



TROLLEYS SERIES COMBI CH

WIDTH = 1425 mm DEPTH = 625 mm HEIGHT (H) = 1590 mm

SIDE FRAMES WITH AND WITHOUT HANDLE, BASES WITH WOODEN PLATE, BASES WITH STEEL PLATE

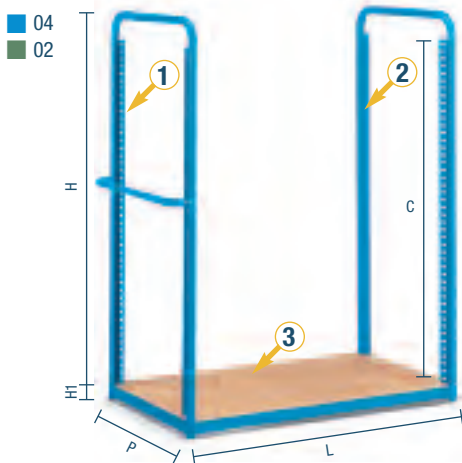

- L = 1425 mm
- P = 625 mm
- H = 1305 mm
- H1 = 43 mm
- C = 1200 mm

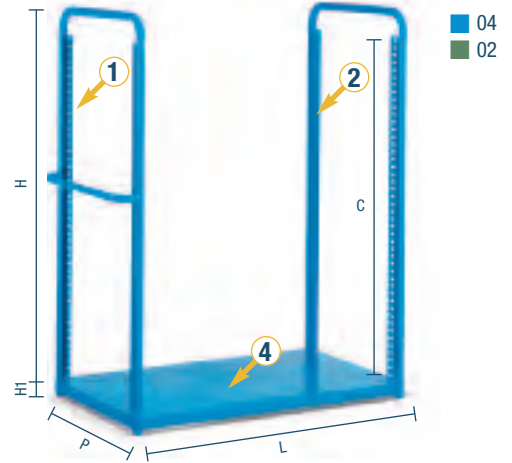

REFERENCE	ORD. NO. SIDE FRAME WITH HANDLE	DIM. mm
①	F CL 0610 00 04	621x105x1360 h
REFERENCE	ORD. NO. BASE WITH WOODEN PLATE	DIM. mm
③	F CE N206 00 04	1345x625x56 h

REFERENCE	ORD. NO. SIDE FRAME	DIM. mm
②	F CL 0620 00 04	621x30x1360 h
REFERENCE	ORD. NO. BASE WITH STEEL PLATE	DIM. mm
④	F CE N205 00 04	1345x625x56 h

ADDITIONAL STEEL SHELVES

ORD. NO.	LOAD CAPACITY kg	FOR TROLLEYS DIM. mm
F CH 0510 00 04	100	1425x625
Dimensions mm 1283x610x30 h		



ORD. NO.

F CH 0590 00 07

Smooth rubber for trolleys. Dimensions mm 1425x625

CONTAINER RETAINERS

ORD. NO.	SUITABLE FOR	FOR TROLLEYS DIM. mm
F CG 0910 00 99	Steel shelf	1425x625
F CG 0912 00 99	Steel and wooden bases	1425x625
Dimensions mm 1275x60		

Order no. FCG 0912 00 99 can only be ordered with the base.



ADDITIONAL WOODEN SHELVES

ORD. NO.	LOAD CAPACITY kg	FOR TROLLEYS DIM. mm
F CH 0560 00 04	100	1425x625
Dimensions mm 1260x600x12 h		



RAL 5012 F.04 RAL 6011 F.02

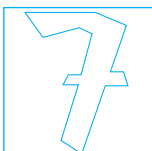

■ Wheels see page E2-E7

KEY

■ All indicated loads are net and refer to evenly distributed weights



WIDTH = 1425 mm DEPTH = 625 mm HEIGHT (H) = 1590 mm

TROLLEYS SERIES COMBI CH

MESHES FOR FRONTS

ORD. NO.	FOR TROLLEYS DIM. mm	MESH HOLE mm
F CL 0630 00 04	1425x625	50x100
Dimensions mm 484x1200		
Single item delivered with 4 clamps		



■ 04
■ 02

MESHES FOR SIDES

ORD. NO.	FOR TROLLEYS DIM. mm	MESH HOLE mm
F CH 0700 00 04	1425x625	50x100
Dimensions mm 1280x1200		
Two items delivered with 8 clamps and bolts		

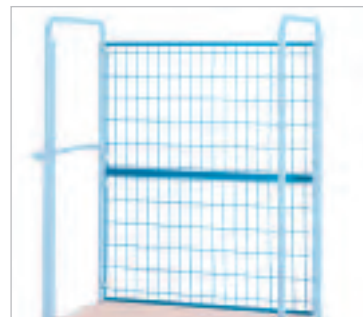

■ 04
■ 02

FORK LIFT BASE

ORD. NO.	DIMENSIONS mm
F CF 0965 00 04	238x615x70 h



■ 04
■ 02



■ INFO

RAL 5012 F.04 RAL 6011 F.02



www.famispa.com

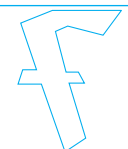

TROLLEYS SERIES COMBI CR



■ All the FCR series trolleys are supplied assembled

TROLLEYS F CR 0091



ORD. NO.

■ 02 ■ 04

F CR 0091 00 04

Trolley with 2 standard rubber swivel wheels **with** brakes and 2 standard rubber fixed wheels \varnothing 100 mm
Load capacity: 150 kg
Dimensions mm 920x510x810 h



ORD. NO.

■ 02 ■ 04

F CR 0091 01 04

Trolley with 2 standard rubber swivel wheels **with** brakes and 2 standard rubber fixed wheels \varnothing 100 mm
Load capacity: 150 kg
Dimensions mm 920x510x810 h

EXTRA STEEL SHELVES
FOR TROLLEYS F CR 0091

ORD. NO.

■ 02 ■ 04

F CR 0715 00 04

Load capacity: 100 kg
Dimensions mm 810x510x54 h

TROLLEYS F CR 0071



ORD. NO.

■ 02 ■ 04

F CR 0071 00 04

Trolley with 2 standard rubber swivel wheels **with** brakes and 2 standard rubber fixed wheels \varnothing 100 mm
Load capacity: 300 kg
Dimensions mm 840x590x955 h



ORD. NO.

■ 02 ■ 04

F CR 0071 01 04

Trolley with:
2 standard rubber swivel wheels **with** brakes
2 standard rubber fixed wheels \varnothing 125 mm
1 storage container ord. no. F PL 8951 00 03 red
1 storage container ord. no. F PL 8951 00 05 yellow
Load capacity: 300 kg
Dimensions mm 840x590x955 h



ORD. NO.

■ 02 ■ 04

F CR 0071 02 04

Trolley with:
2 standard rubber swivel wheels **with** brakes
2 standard rubber fixed wheels \varnothing 125 mm
2 storage containers ord. no. F PM 6551 00 03 red
2 storage containers ord. no. F PM 6551 00 05 yellow
Load capacity: 300 kg
Dimensions mm 840x590x955 h

TROLLEYS SERIES COMBI CR

TROLLEYS F CR 0031



ORD. NO.

■ 02 ■ 04

F CR 0031 00 04

Trolley with 2 standard rubber swivel wheels **with** brakes and 2 standard rubber fixed wheels **Ø 125 mm**

Load capacity: 300 kg

Dimensions mm 765x560x1030 h



ORD. NO.

■ 02 ■ 04

F CR 0031 02 04

Trolley with:

2 standard rubber swivel wheels **with** brakes

2 standard rubber fixed wheels **Ø 125 mm**

2 storage containers ord. no. F PM 6551 00 03 red

2 storage containers ord. no. F PM 6551 00 05 yellow

Load capacity: 300 kg

Dimensions mm 765x560x1030 h



ORD. NO.

■ 02 ■ 04

F CR 0031 03 04

Trolley with:

2 standard rubber swivel wheels **with** brakes

2 standard rubber fixed wheels **Ø 125 mm**

1 storage container ord. no. F PL 8951 00 03 red

1 storage container ord. no. F PL 8951 00 05 yellow

Load capacity: 300 kg

Dimensions mm 765x560x1030 h

TROLLEYS F CR 0021



ORD. NO.

■ 02 ■ 04

F CR 0021 00 04

Trolley with 4 standard rubber swivel wheels **without** brakes **Ø 100 mm**

Load capacity: 150 kg

Dimensions mm 555x445x845 h



ORD. NO.

■ 02 ■ 04

F CR 0021 01 04

Trolley with:

4 standard rubber swivel wheels **without** brakes

Ø 100 mm

2 storage containers ord. no. F PM 4151 00 03 red

2 storage containers ord. no. F PM 4151 00 05 yellow

Load capacity: 150 kg

Dimensions mm 555x445x845 h



ORD. NO.

■ 02 ■ 04

F CR 0021 03 04

Trolley with:

4 standard rubber swivel wheels **without** brakes

Ø 100 mm

1 storage container ord. no. F PM 6551 00 05 yellow

1 storage container ord. no. F PM 6551 00 04 blue

Load capacity: 150 kg

Dimensions mm 555x445x845 h

TROLLEY F CR 0090 WITHOUT WHEELS



ORD. NO.

■ 02 ■ 04

F CR 0090 00 04

Trolley suitable for wheels **Ø 100-125-150**

Dimensions mm 920x510x680 h

TROLLEY F CR 0070 WITHOUT WHEELS



ORD. NO.

■ 02 ■ 04

F CR 0070 00 04

Trolley suitable for wheels **Ø 100-125-150**

Dimensions mm 840x590x800 h

TROLLEY F CR 0030 WITHOUT WHEELS



ORD. NO.

■ 02 ■ 04

F CR 0030 00 04

Trolley suitable for wheels **Ø 100-125-150**

Dimensions mm 765x560x875 h

TROLLEYS SERIES COMBI CP1



TROLLEYS WITH WHEELS



ORD. NO.

F CP 2011 01 99Trolley with 4 standard rubber swivel wheels
without brakes Ø 100 mm

Load capacity: 150 kg

Dim. mm 615x415x170 h

Standard colour:

■ GALVANISED F. 99



ORD. NO.

F CP 2011 02 99Trolley with 4 standard rubber swivel wheels
without brakes Ø 100 mm

Load capacity: 150 kg

Dim. mm 695x415x170/870 h

Standard colour:

■ GALVANISED F. 99

TROLLEYS WITHOUT WHEELS



ORD. NO.

F CP 2010 00 99

Trolley suitable for wheels Ø 100-125-150

Dim. mm 615x415x40 h

Standard colour:

■ GALVANISED F. 99



ORD. NO.

F CP 2010 03 99

Trolley suitable for wheels Ø 100-125-150

Dim. mm 695x415x740 h

Standard colour:

■ GALVANISED F. 99

GALVANISED F. 99

SUPPLEMENTARY PARTS

■ Wheels see
page E2-E7

■ Trolleys FC P are supplied with 4 rubber swivel wheels without brakes



HEIGHT = 1430 mm DEPTH = 613 mm

TROLLEYS SERIES SMART



TROLLEY WITHOUT CONTAINERS

ORD. NO.	DIMENSIONS mm
F LB B073 05 52	725x613x1430 h
Complete with:	
3 shelves depth 420 mm (A=687 mm)	
2 standard rubber swivel wheels with brakes	
2 standard rubber fixed wheels Ø 125 mm	
Load capacity: 300 kg (150 kg per side)	
Standard colour:	
■ GALVANISED + RAL 7000 F. 52	

TROLLEY WITH CONTAINERS

ORD. NO.	DIMENSIONS mm
F LB B073 55 52	725x613x1430 h
Complete with:	
1 trolley ord. no. F LB B073 05 52	
4 storage containers ord. no. F PA 4451 A0 01	
1 storage container ord. no. F PA 6451 A0 01	
1 storage container ord. no. F PA 6851 A0 01	

■ For further information on SMART trolleys go to the Unimod section on page D2



TROLLEY WITHOUT CONTAINERS

ORD. NO.	DIMENSIONS mm
F LB B103 02 52	1023x613x1430 h
Complete with:	
3 shelves depth 600 mm (A=985 mm)	
2 standard rubber swivel wheels with brakes	
2 standard rubber fixed wheels Ø 125 mm	
Load capacity: 300 kg (150 kg per side)	
Standard colour:	
■ GALVANISED + RAL 7000 F. 52	

TROLLEY WITH CONTAINERS

ORD. NO.	DIMENSIONS mm
F LB B103 52 52	1023x613x1430 h
Complete with:	
1 trolley ord. no. F LB B103 02 52	
4 storage containers ord. no. F PA 6451 A0 01	
2 storage containers ord. no. F PA 6851 A0 01	
1 storage container ord. no. F PA 8951 A0 01	

■ For further information on SMART trolleys go to the Unimod section on page D2



■ INFO

GALVANISED F. 99
RAL 7000 F. 01



SMART TROLLEYS ARE IN THE UNIMOD SECTION ON PAGE D2

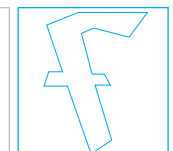
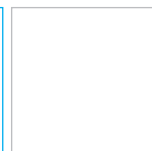
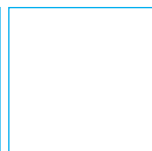

TROLLEYS SERIES SMART

WIDTH = 1023 mm DEPTH = 613 mm

TROLLEY WITH CONTAINERS

ORD. NO.	DIMENSIONS mm
F LB B102 52 52	1023x613x1430 h
Complete with:	
1 trolley ord. no. F LB B102 02 52	
180 containers size 1	

TROLLEY WITHOUT CONTAINERS

ORD. NO.	DIMENSIONS mm
F LB B102 02 52	1023x613x1430 h
Complete with:	
20 shelves for size 1	
2 standard rubber swivel wheels with brake	
2 standard rubber fixed wheels Ø 125 mm	
Load capacity: 300 kg (150 kg per side)	
Standard colour:	
■ GALVANISED + RAL 7000 F. 52	



Rear

■ For further information on SMART trolleys go to the Unimod section on page D2

TROLLEY WITH CONTAINERS

ORD. NO.	DIMENSIONS mm
F LB B102 53 52	1023x613x1430 h
Complete with:	
1 trolley ord. no. F LB B102 03 52	
90 containers size 1	
24 containers size 2	

TROLLEY WITHOUT CONTAINERS

ORD. NO.	DIMENSIONS mm
F LB B102 03 52	1023x613x1430 h
Complete with:	
10 shelves for size 1	
8 shelves for size 2	
2 standard rubber swivel wheels with brake	
2 standard rubber fixed wheels Ø 125 mm	
Load capacity: 300 kg (150 kg per side)	
Standard colour:	
■ GALVANISED + RAL 7000 F. 52	



Rear

■ For further information on SMART trolleys go to the Unimod section on page D2



GALVANISED F. 99
RAL 7000 F. 01

INFO ■

SMART TROLLEYS ARE IN THE
UNIMOD SECTION ON PAGE D2



WIDTH = 1023 mm DEPTH = 613 mm

TROLLEYS SERIES SMART



Rear

■ For further information on SMART trolleys go to the Unimod section on page D2

TROLLEY WITH CONTAINERS

ORD. NO.	DIMENSIONS mm
F LB B102 54 52	1023x613x1430 h
Complete with:	
1 trolley ord. no. F LB B102 04 52	
84 containers size 2	

TROLLEY WITHOUT CONTAINERS

ORD. NO.	DIMENSIONS mm
F LB B102 04 52	1023x613x1430 h
Complete with:	
14 shelves for size 2	
2 standard rubber swivel wheels with brake	
2 standard rubber fixed wheels Ø 125 mm	
Load capacity: 300 kg (150 kg per side)	
Standard colour:	
■ GALVANISED + RAL 7000 F. 52	



Rear

■ For further information on SMART trolleys go to the Unimod section on page D2

TROLLEY WITH CONTAINERS

ORD. NO.	DIMENSIONS mm
F LB B102 56 52	1023x613x1430 h
Complete with:	
1 trolley ord. no. F LB B102 06 52	
45 containers size 1	
24 containers size 2	
28 containers size 3A2	

TROLLEY WITHOUT CONTAINERS

ORD. NO.	DIMENSIONS mm
F LB B102 06 52	1023x613x1430 h
Complete with:	
5 shelves for size 1	
4 shelves for size 2	
6 shelves for size 3A2	
2 standard rubber swivel wheels with brake	
2 standard rubber fixed wheels Ø 125 mm	
Load capacity: 300 kg (150 kg per side)	
Standard colour:	
■ GALVANISED + RAL 7000 F. 52	



■ INFO

GALVANISED F. 99
RAL 7000 F. 01



SMART TROLLEYS ARE IN THE UNIMOD SECTION ON PAGE D2

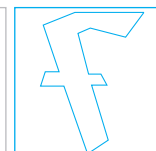
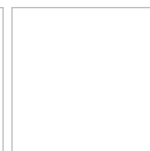
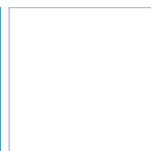
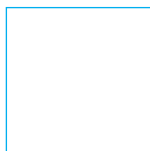

G SPACE

RETHINKING

- SHELVING SYSTEM F ST SERIES SYSTEM
- SHELVING SYSTEM F SV SERIES SYSTEM
- SHELVING SYSTEM F AR SERIES SYSTEM
- SHELVING SYSTEM F SR SERIES SYSTEM

HEAVY DUTY EXTENSION SHELVES LOAD CAPACITY 1000 kg

NORMAL EXTENSION DRAWERS 87% AND FULL EXTENSION DRAWERS 100%

VERSATILE

SEVERAL SERIES AVAILABLE

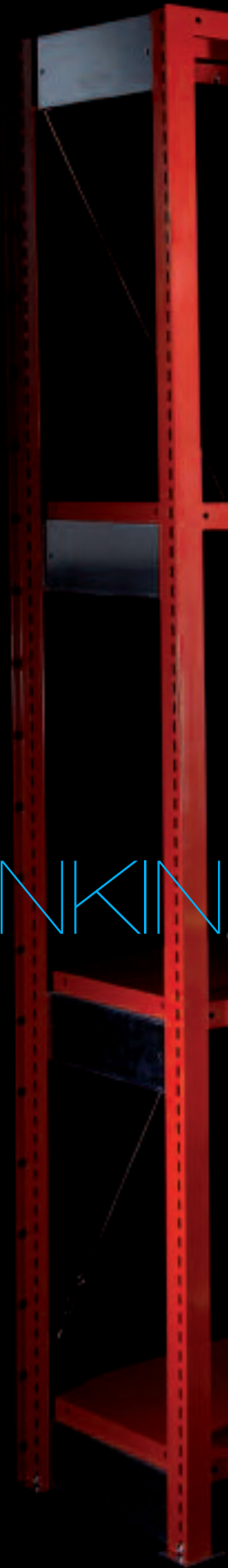

The image shows two industrial shelving units against a black background. The unit on the left is made of silver-colored perforated metal, while the unit on the right is made of yellow-colored perforated metal. Both units have three shelves and are reinforced with diagonal cross-bracing. The lighting is dramatic, highlighting the metallic textures and the geometric structure of the shelving.

G SPACE RETHINKING

SHELVING SYSTEMS SYSTEM ST

SAFETY INFORMATION

WALL FIXING



When fixing shelving to the wall, one wall anchor with a force of **1.3 Kn** (including the safety coefficient) must be used for each upright frame.

FLOOR FIXING



When fixing shelving to the floor, one floor bolt with a force of **4.3 Kn** (including the safety coefficient) must be used for each foot plate.

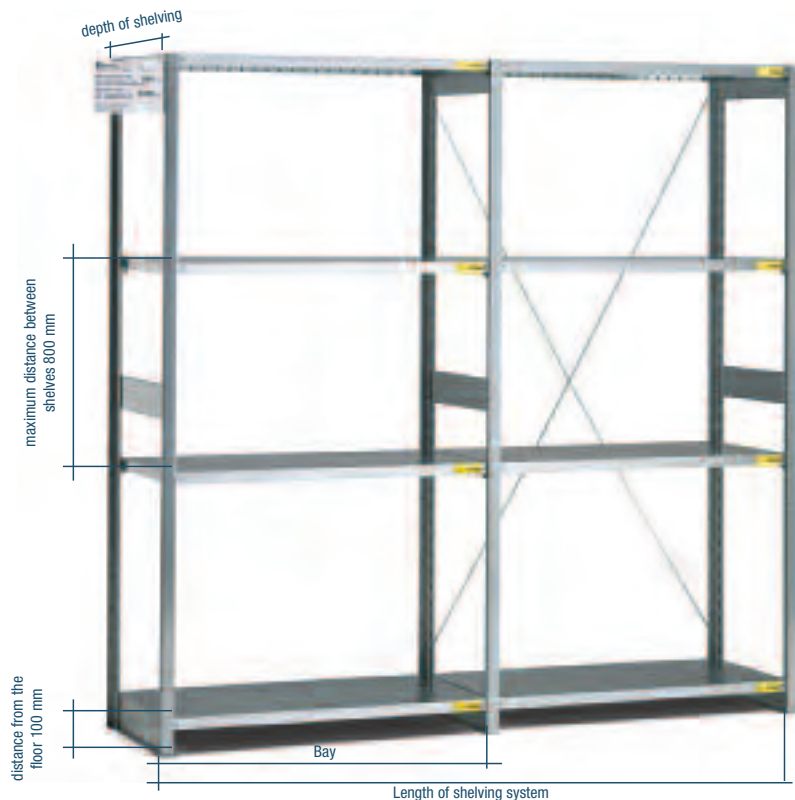

LOAD TABLE AND LABEL

A load table is supplied **standard** with each shelving system and a load label is provided with each shelf or drawer.

- The load table must be attached to a perfectly visible part of the shelving. It shows both the load capacity for each bay and the maximum permitted distance between shelves.
- The load label must be applied to the front of each shelf or drawer.



Example of a **standard** load label for shelves

P.S.: the sum of the load capacities of the shelves in each single bay must never exceed the overall load capacity of the bay indicated in the table.

	Scaffalatura serie Shelving type Regal Serie	ST	Anno di costruzione Year of Manufacture Herstellungsjahr	2002
	Ordine n. / Order no. / Auftrag Nr.			12445
Distanza massima tra i piani Max. distance between shelves Max. Abstand zwischen den Fachböden		800 mm		
Portata per campata Max load capacity per bay Max. Tragfähigkeit pro Feld		2300 Kg		
Carico uniformemente distribuito / Uniformly distributed load / Gleichmäßig verteilte Last				

Example of a **standard** load table

LOAD LABEL IN SCREEN-PRINTED ALUMINIUM

When ordering a F ST shelving system, a load table in screen-printed aluminium complete with tabs for attaching it to the shelving may also be ordered.



Screen-printed load table for front
ORD. NO. F ST 9998 00 00

Screen-printed load table for sides
ORD. NO. F ST 9999 00 00

Position of the front table

Position of the side table



INSTRUCTIONS HANDBOOK

A complete and detailed instructions handbook is supplied standard with the shelving system. This contains the following information:

- technical data
- intended use
- safety information and residue risk areas
- technical table for calculating the required floor strength
- installation and assembly instructions
- fixing instructions.



LENGTH = 2100/3100 mm DEPTH = 500 mm

SHELVING SYSTEM SYSTEM ST



■ 54 ■ 55 ■ 99



■ Trolleys see page E0

ORD. NO.

SHELVES

F ST S200 55 99

12

Including 12 shelves dim. mm 1000x500x35 h

Load capacity of each shelf: 300 kg

Dimensions mm 3100x500x2000 h

■ 54 ■ 55 ■ 99



ORD. NO.

SHELVES

F ST S200 57 99

8

Including 8 shelves dim. mm 1000x500x35 h

Load capacity of each shelf: 300 kg

Dimensions mm 2100x500x2000 h

■ 54 ■ 55 ■ 99



ORD. NO.

SHELVES

F ST S200 58 99

10

Including 10 shelves dim. mm 1000x500x35 h

Load capacity of each shelf: 300 kg

Dimensions mm 2100x500x2000 h

■ KEY



- Load capacity of each bay: **2300 kg**
- Must be fixed to the floor or wall
- All indicated loads are net and refer to evenly distributed weights

■ Fixing set see page E4

RAL 5012
GALVANISEDF.....54RAL 7035
GALVANISEDF.....55

GALVANISEDF.....99

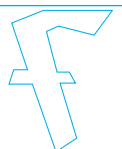

SHELVING SYSTEMS SYSTEM ST20

HEIGHT 2000 mm

- 54
- 55
- 99



1000 mm LONG BAYS

Depth of bay mm	Single bay with cross bracing ORD. NO. galvanised	Add-on bay ORD. NO. galvanised	Add-on bay with cross bracing ORD. NO. galvanised	Single bay with back panel ORD. NO. galvanised	Add-on bay with back panel ORD. NO. galvanised
300	F ST A200 30 99	F ST B200 30 99	–	F ST D200 30 99	F ST E200 30 99
400	F ST A200 40 99	F ST B200 40 99	F ST C200 40 99	F ST D200 40 99	F ST E200 40 99
500	F ST A200 50 99	F ST B200 50 99	F ST C200 50 99	F ST D200 50 99	F ST E200 50 99
600	F ST A200 60 99	F ST B200 60 99	F ST C200 60 99	F ST D200 60 99	F ST E200 60 99
800	F ST A200 80 99	F ST B200 80 99	F ST C200 80 99	F ST D200 80 99	F ST E200 80 99

Each bay has 4 shelves. For 300 mm deep bays, the shelves are supplied without strengthening bars and have a load capacity of 120 kg. For 400 / 500 / 600 / 800 mm deep bays, the shelves are supplied with strengthening bars and have a load capacity of 300 kg.

1300 mm LONG BAYS

Depth of bay mm	Single bay with cross bracing ORD. NO. galvanised	Add-on bay ORD. NO. galvanised	Add-on bay with cross bracing ORD. NO. galvanised	Single bay with back panel ORD. NO. galvanised	Add-on bay with back panel ORD. NO. galvanised
300	F ST F200 30 99	F ST G200 30 99	–	F ST L200 30 99	F ST M200 30 99
400	F ST F200 40 99	F ST G200 40 99	F ST H200 40 99	F ST L200 40 99	F ST M200 40 99
500	F ST F200 50 99	F ST G200 50 99	F ST H200 50 99	F ST L200 50 99	F ST M200 50 99
600	F ST F200 60 99	F ST G200 60 99	F ST H200 60 99	F ST L200 60 99	F ST M200 60 99
800	F ST F200 80 99	F ST G200 80 99	F ST H200 80 99	F ST L200 80 99	F ST M200 80 99

Each bay has 4 shelves. For 300 mm deep bays, the shelves are supplied without strengthening bars and have a load capacity of 100 kg. For 600 mm deep bays, the shelves are supplied with strengthening bars and have a load capacity of 200 kg. For 400 / 500 / 800 mm deep bays, the shelves are supplied with strengthening bars and have a load capacity of 230 kg.

■ A cross bracing or a back panel must be fitted to each third bay (this does not apply to bays fixed to the wall)

FLOOR SET FIXING

Fixing material including no. 2 steel floor bolts M8x75 mm for uninterrupted concrete floors equal to or higher than class: B25 / RBK250 / MPa 25N for mm².
ORD. NO. F NC 8999 00 99

WALL SET FIXING

■ All the bays which must be fixed to the wall are supplied standard with wall brackets.

FOOT PLATES FIXING

■ The single bays are supplied with an Allen key for fixing the foot plates.

RAL 5012 GALVANISEDF.....54 RAL 7035 GALVANISEDF.....55 GALVANISEDF.....99

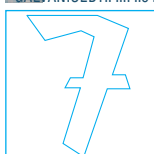

■ The bays are supplied unassembled complete with foot plates

■ Load capacity of each bay: **2300 kg**

■ Must be fixed to the floor or wall

KEY ■

- Must be fixed to the wall or floor
- Must be fixed to the wall

■ All indicated loads are net and refer to evenly distributed weights



LENGTH = 1000/1300 mm HEIGHT = 2200 mm

SHELVING SYSTEM SYSTEM ST22

HEIGHT 2200 mm

■ 54
■ 55
■ 99



1000 mm LONG BAYS

Depth of bay mm	Single bay with cross bracing ORD. NO. galvanised	Add-on bay ORD. NO. galvanised	Add-on bay with cross bracing ORD. NO. galvanised	Single bay with back panel ORD. NO. galvanised	Add-on bay with back panel ORD. NO. galvanised
300	F ST A220 30 99	F ST B220 30 99	—	F ST D220 30 99	F ST E220 30 99
400	F ST A220 40 99	F ST B220 40 99	F ST C220 40 99	F ST D220 40 99	F ST E220 40 99
500	F ST A220 50 99	F ST B220 50 99	F ST C220 50 99	F ST D220 50 99	F ST E220 50 99
600	F ST A220 60 99	F ST B220 60 99	F ST C220 60 99	F ST D220 60 99	F ST E220 60 99
800	F ST A220 80 99	F ST B220 80 99	F ST C220 80 99	F ST D220 80 99	F ST E220 80 99

Each bay has 4 shelves. For 300 mm deep bays, the shelves are supplied without strengthening bars and have a load capacity of 120 kg.

For 400 / 500 / 600 / 800 mm deep bays, the shelves are supplied with strengthening bars and have a load capacity of 300 kg.

1300 mm LONG BAYS

Depth of bay mm	Single bay with cross bracing ORD. NO. galvanised	Add-on bay ORD. NO. galvanised	Add-on bay with cross bracing ORD. NO. galvanised	Single bay with back panel ORD. NO. galvanised	Add-on bay with back panel ORD. NO. galvanised
300	F ST F220 30 99	F ST G220 30 99	—	F ST L220 30 99	F ST M220 30 99
400	F ST F220 40 99	F ST G220 40 99	F ST H220 40 99	F ST L220 40 99	F ST M220 40 99
500	F ST F220 50 99	F ST G220 50 99	F ST H220 50 99	F ST L220 50 99	F ST M220 50 99
600	F ST F220 60 99	F ST G220 60 99	F ST H220 60 99	F ST L220 60 99	F ST M220 60 99
800	F ST F220 80 99	F ST G220 80 99	F ST H220 80 99	F ST L220 80 99	F ST M220 80 99

Each bay has 4 shelves. For 300 mm deep bays, the shelves are supplied without strengthening bars and have a load capacity of 100 kg.

For 600 mm deep bays, the shelves are supplied with strengthening bars and have a load capacity of 200 kg.

For 400 / 500 / 800 mm deep bays, the shelves are supplied with strengthening bars and have a load capacity of 230 kg.

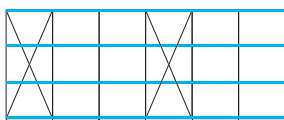

■ A cross bracing or a back panel must be fitted to each third bay (this does not apply to bays fixed to the wall)

FLOOR SET FIXING



Fixing material including no. 2 steel floor bolts M8x75 mm for uninterrupted concrete floors equal to or higher than class: B25 / RBK250 / MP. 25N for mm².

ORD. NO. F NC 8999 00 99

WALL SET FIXING



■ All the bays which must be fixed to the wall are supplied standard with wall brackets.

FOOT PLATES FIXING



■ The single bays are supplied with an Allen key for fixing the foot plates.

■ KEY



Must be fixed to the wall or floor

Must be fixed to the wall

■ All indicated loads are net and refer to evenly distributed weights

■ The bays are supplied unassembled complete with foot plates

RAL 5012
GALVANISEDF.....54

■ Load capacity of each bay:
2300 kg

RAL 7035
GALVANISEDF.....55

■ Must be fixed to the floor or wall

GALVANISEDF.....99

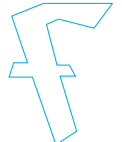

SHELVING SYSTEMS SYSTEM ST25

HEIGHT 2500 mm

- 54
- 55
- 99



1000 mm LONG BAYS

Depth of bay mm	Single bay with cross bracing ORD. NO. galvanised	Add-on bay ORD. NO. galvanised	Add-on bay with cross bracing ORD. NO. galvanised	Single bay with back panel ORD. NO. galvanised	Add-on bay with back panel ORD. NO. galvanised
300	F ST A250 30 99	F ST B250 30 99	–	F ST D250 30 99	F ST E250 30 99
400	F ST A250 40 99	F ST B250 40 99	–	F ST D250 40 99	F ST E250 40 99
500	F ST A250 50 99	F ST B250 50 99	F ST C250 50 99	F ST D250 50 99	F ST E250 50 99
600	F ST A250 60 99	F ST B250 60 99	F ST C250 60 99	F ST D250 60 99	F ST E250 60 99
800	F ST A250 80 99	F ST B250 80 99	F ST C250 80 99	F ST D250 80 99	F ST E250 80 99

Each bay has 5 shelves. For 300 mm deep bays, the shelves are supplied without strengthening bars and have a load capacity of 120 kg. For 400 / 500 / 600 / 800 mm deep bays, the shelves are supplied with strengthening bars and have a load capacity of 300 kg.

1300 mm LONG BAYS

Depth of bay mm	Single bay with cross bracing ORD. NO. galvanised	Add-on bay ORD. NO. galvanised	Add-on bay with cross bracing ORD. NO. galvanised	Single bay with back panel ORD. NO. galvanised	Add-on bay with back panel ORD. NO. galvanised
300	F ST F250 30 99	F ST G250 30 99	–	F ST L250 30 99	F ST M250 30 99
400	F ST F250 40 99	F ST G250 40 99	–	F ST L250 40 99	F ST M250 40 99
500	F ST F250 50 99	F ST G250 50 99	F ST H250 50 99	F ST L250 50 99	F ST M250 50 99
600	F ST F250 60 99	F ST G250 60 99	F ST H250 60 99	F ST L250 60 99	F ST M250 60 99
800	F ST F250 80 99	F ST G250 80 99	F ST H250 80 99	F ST L250 80 99	F ST M250 80 99

Each bay has 5 shelves. For 300 mm deep bays, the shelves are supplied without strengthening bars and have a load capacity of 100 kg. For 600 mm deep bays, the shelves are supplied with strengthening bars and have a load capacity of 200 kg. For 400 / 500 / 800 mm deep bays, the shelves are supplied with strengthening bars and have a load capacity of 230 kg.

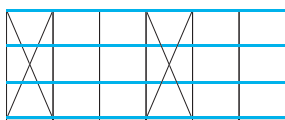

■ A cross bracing or a back panel must be fitted to each third bay (this does not apply to bays fixed to the wall)

FLOOR SET FIXING



Fixing material including no. 2 steel floor bolts M8x75 mm for uninterrupted concrete floors equal to or higher than class: B25 / RBK250 / MPa 25N for mm².
ORD. NO. F NC 8999 00 99

WALL SET FIXING



■ All the bays which must be fixed to the wall are supplied standard with wall brackets.

FOOT PLATES FIXING



■ The single bays are supplied with an Allen key for fixing the foot plates.

RAL 5012 GALVANISEDF.....54

RAL 7035 GALVANISEDF.....55

GALVANISEDF.....99

KEY ■

- Must be fixed to the wall or floor
- Must be fixed to the wall

■ All indicated loads are net and refer to evenly distributed weights

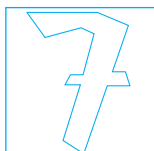

■ The bays are supplied unassembled complete with foot plates

■ Load capacity of each bay: **2300 kg**

■ Must be fixed to the floor or wall

LENGTH = 1000/1300 mm HEIGHT = 3000 mm

SHELVING SYSTEM SYSTEM ST30

HEIGHT 3000 mm

■ 54
■ 55
■ 99



1000 mm LONG BAYS

Depth of bay mm	Single bay with cross bracing ORD. NO. galvanised	Add-on bay ORD. NO. galvanised	Add-on bay with cross bracing ORD. NO. galvanised	Single bay with back panel ORD. NO. galvanised	Add-on bay with back panel ORD. NO. galvanised
300	F ST A300 30 99	F ST B300 30 99	—	F ST D300 30 99	F ST E300 30 99
400	F ST A300 40 99	F ST B300 40 99	—	F ST D300 40 99	F ST E300 40 99
500	F ST A300 50 99	F ST B300 50 99	F ST C300 50 99	F ST D300 50 99	F ST E300 50 99
600	F ST A300 60 99	F ST B300 60 99	F ST C300 60 99	F ST D300 60 99	F ST E300 60 99
800	F ST A300 80 99	F ST B300 80 99	F ST C300 80 99	F ST D300 80 99	F ST E300 80 99

Each bay has 6 shelves. For 300 mm deep bays, the shelves are supplied without strengthening bars and have a load capacity of 120 kg. For 400 / 500 / 600 / 800 mm deep bays, the shelves are supplied with strengthening bars and have a load capacity of 300 kg.

1300 mm LONG BAYS

Depth of bay mm	Single bay with cross bracing ORD. NO. galvanised	Add-on bay ORD. NO. galvanised	Add-on bay with cross bracing ORD. NO. galvanised	Single bay with back panel ORD. NO. galvanised	Add-on bay with back panel ORD. NO. galvanised
300	F ST F300 30 99	F ST G300 30 99	—	F ST L300 30 99	F ST M300 30 99
400	F ST F300 40 99	F ST G300 40 99	—	F ST L300 40 99	F ST M300 40 99
500	F ST F300 50 99	F ST G300 50 99	F ST H300 50 99	F ST L300 50 99	F ST M300 50 99
600	F ST F300 60 99	F ST G300 60 99	F ST H300 60 99	F ST L300 60 99	F ST M300 60 99
800	F ST F300 80 99	F ST G300 80 99	F ST H300 80 99	F ST L300 80 99	F ST M300 80 99

Each bay has 6 shelves. For 300 mm deep bays, the shelves are supplied without strengthening bars and have a load capacity of 100 kg. For 600 mm deep bays, the shelves are supplied with strengthening bars and have a load capacity of 200 kg. For 400 / 500 / 800 mm deep bays, the shelves are supplied with strengthening bars and have a load capacity of 230 kg.

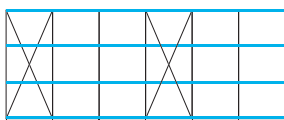

■ A cross bracing or a back panel must be fitted to each third bay (this does not apply to bays fixed to the wall)

FLOOR SET FIXING



Fixing material including no. 2 steel floor bolts M8x75 mm for uninterrupted concrete floors equal to or higher than class: B25 / RBK250 / MP. 25N for mm².

ORD. NO. F NC 8999 00 99

WALL SET FIXING



■ All the bays which must be fixed to the wall are supplied standard with wall brackets.

FOOT PLATES FIXING



■ The single bays are supplied with an Allen key for fixing the foot plates.

KEY



Must be fixed to the wall or floor

Must be fixed to the wall

■ All indicated loads are net and refer to evenly distributed weights

■ The bays are supplied unassembled complete with foot plates

RAL 5012
GALVANISEDF.....54

■ Load capacity of each bay:
2300 kg

RAL 7035
GALVANISEDF.....55

■ Must be fixed to the floor or wall

GALVANISEDF.....99

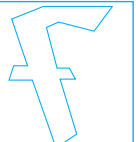

SHELVING SYSTEMS SYSTEM ST

UPRIGHT FRAMES 1000 mm h

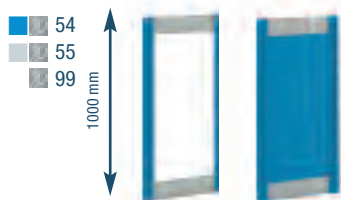

Depth of bay mm	Upright frame with 2 connection bars ORD. NO.	Upright frame with 2 connection bars + intermediate panel 1000 mm h ORD. NO.
300	F ST 0100 30 54	F ST 0101 30 54
400	F ST 0100 40 54	F ST 0101 40 54
500	F ST 0100 50 54	F ST 0101 50 54
600	F ST 0100 60 54	F ST 0101 60 54
800	F ST 0100 80 54	F ST 0101 80 54

UPRIGHT FRAMES 2000 mm h

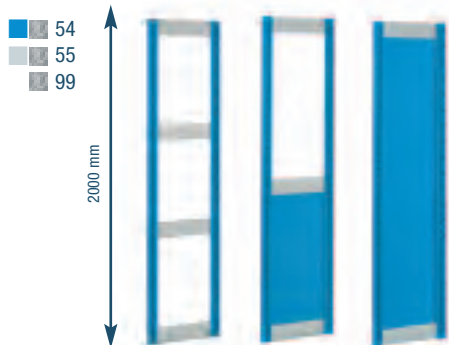

Depth of bay mm	Upright frame with 4 connection bars ORD. NO.	Upright frame with 3 connection bars + intermediate panel 1000 mm h ORD. NO.	Upright frame with 2 connection bars + intermediate panel 2000 mm h ORD. NO.
300	F ST 0200 30 54	F ST 0201 30 54	F ST 0202 30 54
400	F ST 0200 40 54	F ST 0201 40 54	F ST 0202 40 54
500	F ST 0200 50 54	F ST 0201 50 54	F ST 0202 50 54
600	F ST 0200 60 54	F ST 0201 60 54	F ST 0202 60 54
800	F ST 0200 80 54	F ST 0201 80 54	F ST 0202 80 54

UPRIGHT FRAMES 2200 mm h



Depth of bay mm	Upright frame with 4 connection bars ORD. NO.	Upright frame with 3 connection bars + intermediate panel 1000 mm h ORD. NO.	Upright frame with 3 connection bars + intermediate panel 2000 mm h ORD. NO.	Upright frame with 2 connection bars + intermediate panel 2200 mm h ORD. NO.
300	F ST 0220 30 54	F ST 0221 30 54	F ST 0222 30 54	F ST 0223 30 54
400	F ST 0220 40 54	F ST 0221 40 54	F ST 0222 40 54	F ST 0223 40 54
500	F ST 0220 50 54	F ST 0221 50 54	F ST 0222 50 54	F ST 0223 50 54
600	F ST 0220 60 54	F ST 0221 60 54	F ST 0222 60 54	F ST 0223 60 54
800	F ST 0220 80 54	F ST 0221 80 54	F ST 0222 80 54	F ST 0223 80 54

FLOOR SET FIXING



Fixing material including no. 2 steel floor bolts M8x75 mm for uninterrupted concrete floors equal to or higher than class: B25 / RBK250 / MP, 25N for mm².
ORD. NO. F NC 8999 00 99

CONNECTION SET FOR BACK TO BACK UPRIGHT FRAMES



The clips are made of galvanised steel and are inserted into the rear of the upright frames. Each connection set includes 4 galvanised clips. ORD. NO. F ST 0720 00 99

WALL SET FIXING



■ All the bays which must be fixed to the wall are supplied standard with wall brackets.

FOOT PLATES FIXING



■ The single bays are supplied with an Allen key for fixing the foot plates.

RAL 5012 GALVANISEDF.....54 RAL 7035 GALVANISEDF.....55 GALVANISEDF.....99

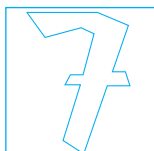

■ The bays are supplied unassembled complete with foot plates

KEY ■

- Must be fixed to the wall or floor
- Must be fixed to the wall



HEIGHT = 2500 / 3000 mm

SHELVING SYSTEM SYSTEM ST

UPRIGHT FRAMES 2500 mm h



Side, intermediate, back panels and doors can be used to turn all or part of the shelving unit into a cabinet.

Depth of bay mm	Upright frame with 4 connection bars		Upright frame with 4 connection bars + intermediate panel 1000 mm h		Upright frame with 3 connection bars + intermediate panel 2000 mm h		Upright frame with 3 connection bars + intermediate panel 2200 mm h		Upright frame with 3 connection bars + intermediate panel 2500 mm h	
		ORD. NO.		ORD. NO.		ORD. NO.		ORD. NO.		ORD. NO.
300	F ST 0250 30 54	F ST 0251 30 54	F ST 0252 30 54	F ST 0253 30 54	F ST 0254 30 54					
400	F ST 0250 40 54	F ST 0251 40 54	F ST 0252 40 54	F ST 0253 40 54	F ST 0254 40 54					
500	F ST 0250 50 54	F ST 0251 50 54	F ST 0252 50 54	F ST 0253 50 54	F ST 0254 50 54					
600	F ST 0250 60 54	F ST 0251 60 54	F ST 0252 60 54	F ST 0253 60 54	F ST 0254 60 54					
800	F ST 0250 80 54	F ST 0251 80 54	F ST 0252 80 54	F ST 0253 80 54	F ST 0254 80 54					

UPRIGHT FRAMES 3000 mm h



Depth of bay mm	Upright frame with 6 connection bars		Upright frame with 4 connection bars + intermediate panel 1000 mm h		Upright frame with 3 connection bars + intermediate panel 2000 mm h		Upright frame with 3 connection bars + intermediate panel 2200 mm h		Upright frame with 3 connection bars + intermediate panel 2500 mm h		Upright frame with 2 connection bars + intermediate panel 3000 mm h	
		ORD. NO.		ORD. NO.		ORD. NO.		ORD. NO.		ORD. NO.		ORD. NO.
300	F ST 0300 30 54	F ST 0301 30 54	F ST 0302 30 54	F ST 0303 30 54	F ST 0304 30 54	F ST 0305 30 54						
400	F ST 0300 40 54	F ST 0301 40 54	F ST 0302 40 54	F ST 0303 40 54	F ST 0304 40 54	F ST 0305 40 54						
500	F ST 0300 50 54	F ST 0301 50 54	F ST 0302 50 54	F ST 0303 50 54	F ST 0304 50 54	F ST 0305 50 54						
600	F ST 0300 60 54	F ST 0301 60 54	F ST 0302 60 54	F ST 0303 60 54	F ST 0304 60 54	F ST 0305 60 54						
800	F ST 0300 80 54	F ST 0301 80 54	F ST 0302 80 54	F ST 0303 80 54	F ST 0304 80 54	F ST 0305 80 54						

KEY



- Must be fixed to the wall or floor
- Must be fixed to the wall

The bays are supplied unassembled complete with foot plates

RAL 5012 GALVANISEDF.....54

RAL 7035 GALVANISEDF.....55

GALVANISEDF.....99



SHELVING SYSTEMS SYSTEM ST

SLOTTED SHELVES LENGTH 1000 mm

ORD. NO.	DIMENSIONS mm	NO. OF BARS	LOAD CAPACITY kg
F ST 1030 00 04	1000x300x35 h	–	120
F ST 1040 00 04	1000x400x35 h	–	120
F ST 1040 01 04	1000x400x35 h	1	300
F ST 1050 00 04	1000x500x35 h	–	120
F ST 1050 01 04	1000x500x35 h	1	300
F ST 1050 02 04	1000x500x35 h	2	400
F ST 1060 00 04	1000x600x35 h	–	120
F ST 1060 01 04	1000x600x35 h	1	300
F ST 1060 02 04	1000x600x35 h	2	400
F ST 1080 00 04	1000x800x35 h	–	120
F ST 1080 01 04	1000x800x35 h	1	300
F ST 1080 02 04	1000x800x35 h	2	400



The shelves are slotted at 40.5 mm increments in order to hold shelf dividers or shelf panels. The special folds on the long sides considerably reinforce the shelf structure. Strengthening bars can be added, without the aid of screws, to increase the load capacity of the shelves.

Available galvanised, blue Ral 5012 or gray Ral 7035.



■ The shelves in this series are supplied with load labels.

SLOTTED SHELVES LENGTH 1300 mm

ORD. NO.	DIMENSIONS mm	NO. OF BARS	LOAD CAPACITY kg
F ST 1130 00 04	1300x300x35 h	–	100
F ST 1140 00 04	1300x400x35 h	–	100
F ST 1140 01 04	1300x400x35 h	1	230
F ST 1150 00 04	1300x500x35 h	–	100
F ST 1150 01 04	1300x500x35 h	1	230
F ST 1150 02 04	1300x500x35 h	2	300
F ST 1160 00 04	1300x600x35 h	–	100
F ST 1160 01 04	1300x600x35 h	1	200
F ST 1160 02 04	1300x600x35 h	2	300
F ST 1180 00 04	1300x800x35 h	–	100
F ST 1180 01 04	1300x800x35 h	1	230
F ST 1180 02 04	1300x800x35 h	2	300



Assembling the strengthening bar and the shelf

STRENGTHENING BAR LENGTH 1000 mm

■ 99



ORD. NO. R FST 0005 99

SET OF 4 SPARE GALVANISED CLIPS

■ 99



ORD. NO. R FST 0003 99

STRENGTHENING BAR LENGTH 1300 mm

■ 99



ORD. NO. R FST 0006 99

MAGNETIC SUPPORT WITH LABEL



ORD. NO. F ST 9997 00 00

Magnetic support with label and cellophane length 1000 mm

ORD. NO. R FST 0007 00

Spare label and cellophane (100 pcs)

SPARE STRENGTHENING BAR FOR SHELVES 800 mm DEEP

■ 99



ORD. NO. R FST 0004 99



LENGTH = 1000 / 1300 mm

SHELVING SYSTEM SYSTEM ST

Assembling the base plinth

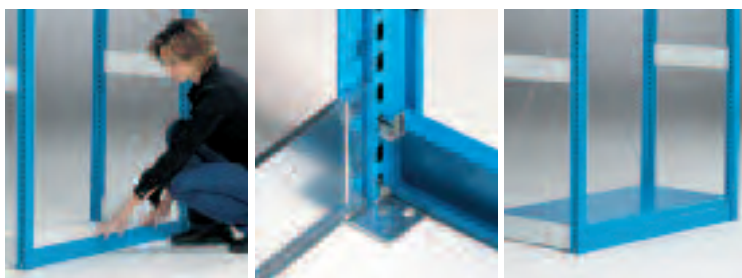

BASE PLINTHS

■ 04
■ 08
■ 99

ORD. NO.	LENGTH mm
F ST 7510 00 04	1000
F ST 7520 00 04	1300

The base plinths are used to close the lower part of the shelving. They are assembled without screws and are available in two lengths: 1000 mm and 1300 mm. Available galvanised, blue Ral 5012 or grey Ral 7035.

SLIDING DOORS



■ 04
■ 08

The sliding doors increase the shelving depth of 80 mm and one pair of doors closes 2 shelving bays. Available for 1000 mm and 1300 mm long bays, they are easy to be assembled (just 6 screws are used for a pair of doors). The doors are supplied with a safety lock and 2 keys.

Available in blue Ral 5012 or grey Ral 7035.



■ This type of door closes 2 bays



ORD. NO.	DIMENSIONS LxH mm
F ST 5720 00 04	2000x2000 h
F ST 5820 00 04	2600x2000 h

FOOT PLATES FIXING



■ Allen key supplied standard

LEAF DOORS



■ 04
■ 08

The leaf doors increase the shelving depth of 22 mm and one pair of doors closes one shelving bay. Available for 1000 mm and 1300 mm long bays, they are easy to be assembled (just 4 screws are used for a pair of doors). The doors are supplied with a safety lock and 2 keys.

Available in blue Ral 5012 or grey Ral 7035.



■ This type of door closes 1 bay



ORD. NO.	DIMENSIONS LxH mm
F ST 5110 00 04	1000x1000 h
F ST 5120 00 04	1000x2000 h
F ST 5210 00 04	1300x1000 h
F ST 5220 00 04	1300x2000 h

FOOT PLATES FIXING



■ Allen key supplied standard

SHELVING SYSTEMS SYSTEM ST

CROSS BRACINGS



ORD. NO. GALVANISED	DIM. LxH mm
F ST 7110 00 99	1000x1000 h
F ST 7120 00 99	1000x2000 h
F ST 7122 00 99	1000x2200 h
F ST 7125 00 99	1000x2500 h
F ST 7130 00 99	1000x3000 h

ORD. NO. GALVANISED	DIM. LxH mm
F ST 7210 00 99	1300x1000 h
F ST 7220 00 99	1300x2000 h
F ST 7222 00 99	1300x2200 h
F ST 7225 00 99	1300x2500 h
F ST 7230 00 99	1300x3000 h



The cross bracing is attached to the shelving from the front side without using screws. This system makes assembly easy especially if the shelving is positioned against the wall.

Available galvanised.

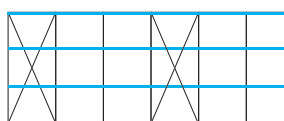

■ A cross bracing must be fitted to each third bay

Assembling the cross bracing



MESH BACK PANELS

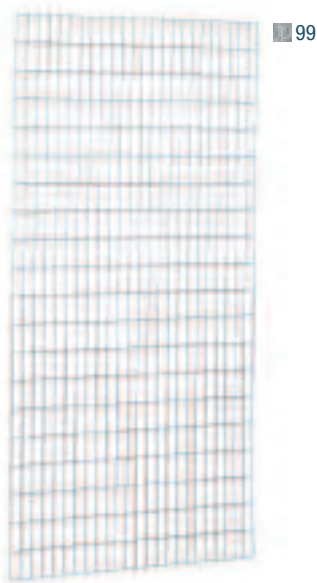

Mesh size 40.5x100 mm h

ORD. NO. GALVANISED	DIM. LxH mm
F ST 2820 10 99	1000x2000 h
F ST 2822 10 99	1000x2200 h
F ST 2825 10 99	1000x2500 h
F ST 2830 10 99	1000x3000 h

ORD. NO. GALVANISED	DIM. LxH mm
F ST 2820 13 99	1300x2000 h
F ST 2822 13 99	1300x2200 h
F ST 2825 13 99	1300x2500 h
F ST 2830 13 99	1300x3000 h

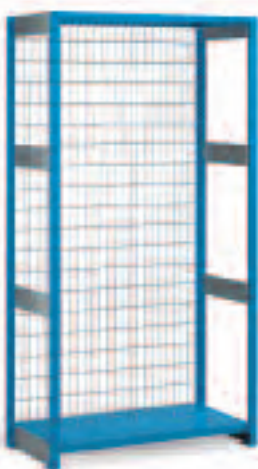

SPARE CLIPS FOR MESH PANEL

ORD. NO. R FST 0002 99



The mesh back panel is attached to the shelving from the front side using galvanised hooks. This system makes assembly easy especially if the shelving is positioned against the wall. **Available galvanised.**

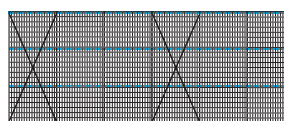

■ A cross bracing must be fitted to each third bay

Assembling the mesh panel



LENGTH = 1000 / 1300 mm

SHELVING SYSTEM SYSTEM ST

BACK PANELS



- 04
- 08
- 99

ORD. NO. GALVANISED DIM. LxH mm

F ST 2020 10 04	1000x2000 h
F ST 2022 10 04	1000x2200 h
F ST 2025 10 04	1000x2500 h
F ST 2030 10 04	1000x3000 h

ORD. NO. GALVANISED DIM. LxH mm

F ST 2020 13 04	1300x2000 h
F ST 2022 13 04	1300x2200 h
F ST 2025 13 04	1300x2500 h
F ST 2030 13 04	1300x3000 h



The back panels are also attached to the shelving from the front. No screws are used. This system makes assembly easy especially if the shelving is positioned against the wall. Supplied in various sections depending on the height of the shelving.

Available galvanised, blue Ral 5012 or grey Ral 7035.

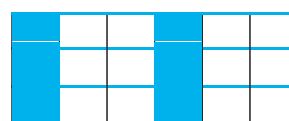

- A back panel must be fitted to each third bay

Assembling the back panel



STRENGTHENING BARS



ORD. NO. GALVANISED FOR BAYS LENGTH mm

F ST 9550 01 99*	1000
F ST 9560 01 99*	1300

*Set of 4 strengthening bars and 8 supports

This set includes 4 strengthening bars and 8 supports and is used to strengthen the shelving without having to use cross bracings or back panels. Two bars must be fitted at the top and two at the bottom of each bay. Available galvanised.

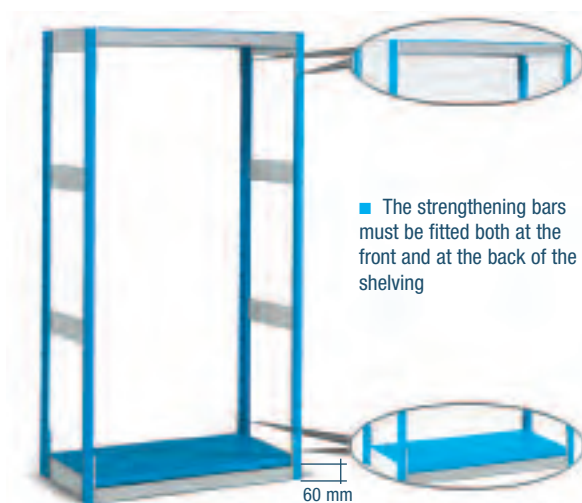

- The strengthening bars must be fitted both at the front and at the back of the shelving

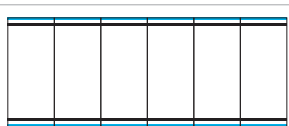

- The strengthening bars set must be fixed on each bay.

Assembling the strengthening bars



SHELVING SYSTEMS SYSTEM ST

SHELF DIVIDERS

The shelf dividers are fitted into the shelf slots. They have a **standard height of 100 mm** and are supplied **galvanised**.

■ 99



ORD. NO. GALVANISED	DEPTH OF SHELVING mm
F ST 9230 00 99	300
F ST 9240 00 99	400
F ST 9250 00 99	500
F ST 9260 00 99	600
F ST 9280 00 99	800

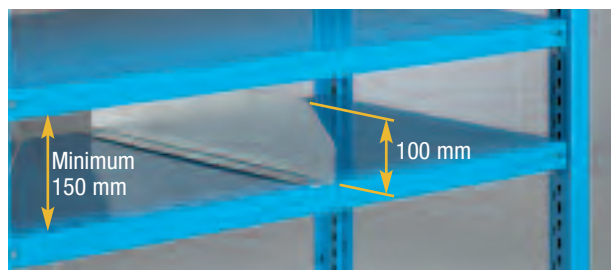

Assembling a shelf divider



SHELF PANELS

The shelf panels are fitted into the slots between two shelves. They are available **galvanised** and in various heights ranging from 165 to 415 mm and in 5 different depths.

■ 99



Assembling a shelf panel

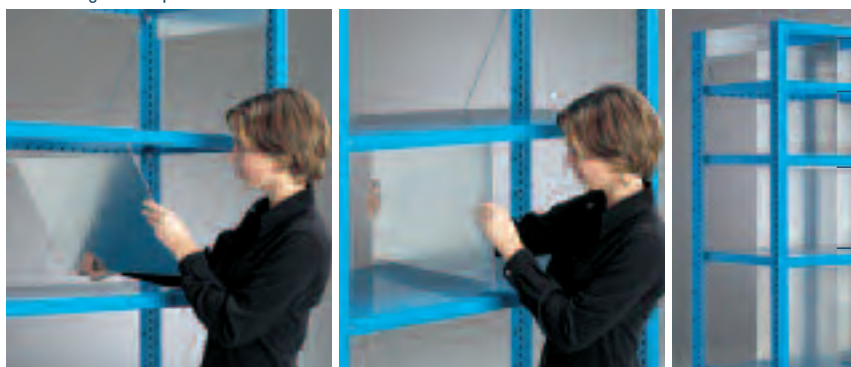

Distance between shelves

Space between shelves

Space between shelves mm	Distance between shelves mm	Depth of shelving unit 300 mm ORD. NO. galvanised	Depth of shelving unit 400 mm ORD. NO. galvanised	Depth of shelving unit 500 mm ORD. NO. galvanised	Depth of shelving unit 600 mm ORD. NO. galvanised	Depth of shelving unit 800 mm ORD. NO. galvanised
165	200	F ST 9000 00 99	F ST 9030 00 99	F ST 9060 00 99	F ST 9090 00 99	F ST 9150 00 99
215	250	F ST 9005 00 99	F ST 9035 00 99	F ST 9065 00 99	F ST 9095 00 99	F ST 9155 00 99
265	300	F ST 9010 00 99	F ST 9040 00 99	F ST 9070 00 99	F ST 9100 00 99	F ST 9160 00 99
315	350	F ST 9015 00 99	F ST 9045 00 99	F ST 9075 00 99	F ST 9105 00 99	F ST 9165 00 99
365	400	F ST 9020 00 99	F ST 9050 00 99	F ST 9080 00 99	F ST 9110 00 99	F ST 9170 00 99
415	450	F ST 9025 00 99	F ST 9055 00 99	F ST 9085 00 99	F ST 9115 00 99	F ST 9175 00 99

DEPTH = 300 / 400 / 500 / 600 / 800 mm

SHELVING SYSTEM SYSTEM ST

SET OF TROUGH PANELS AND TAPERED TROUGH DIVIDERS

Both trough panels are slotted in 50 mm increments to fit the tapered dividers. Assembly is quick and easy. **No screws are used.** The trough panels are available **galvanised, blue Ral 5012 or grey Ral 7035**, while the tapered dividers are available **galvanised only**.

■ 54
■ 55
■ 99



■ 99



SET OF TROUGH PANELS WITH TWO TAPERED TROUGH DIVIDERS FOR 1000 mm LONG SHELVES

ORD. NO.	DEPTH mm
F ST 9510 30 54	300
F ST 9510 40 54	400
F ST 9510 50 54	500
F ST 9510 60 54	600

SET OF TROUGH PANELS WITH TWO TAPERED TROUGH DIVIDERS FOR 1300 mm LONG SHELVES

ORD. NO.	DEPTH mm
F ST 9520 30 54	300
F ST 9520 40 54	400
F ST 9520 50 54	500
F ST 9520 60 54	600

ADDITIONAL TAPERED TROUGH DIVIDER

ORD. NO.	DEPTH mm
F ST 9630 00 99	300
F ST 9640 00 99	400
F ST 9650 00 99	500
F ST 9660 00 99	600



Assembling the trough panels and the tapered trough dividers

FULL EXTENSION SUSPENSION FOLDER FRAME FOR SUSPENSION FOLDER DIN A4

The suspension folder frames are supplied with full extension guide rails (100% extraction) with 30 Kg load capacity. Overall dimensions 990x500 mm. **These frames can only be used for 1000 mm long and 500 mm deep bays.** Available in **black Ral 9011**.



NORMAL EXTENSION AND FULL EXTENSION DRAWERS

The drawers are available either with normal extension (88% extraction) or full extension (100% extraction) guide rails with a front height of 100 mm. The slotted internal side walls and perforated bottom with 17 mm fixed increments make the metal partitions easy to be inserted and fixed (with screws). They are made from sheet steel and **can only be used for 1000 mm long and 500 mm deep bays.** Available **blue Ral 5012 or grey Ral 7035**.

NORMAL EXTENSION DRAWERS

ORD. NO.	FRONT HEIGHT mm	LOAD CAPACITY kg	USABLE DIMENSIONS mm
F ST 8510 00 04	100	50	906x447x85 h

Extension (88%)

A maximum of 6 drawers can be fitted on each bay. The maximum permitted height for fitting drawers is 1000 mm.

FULL EXTENSION DRAWERS

ORD. NO.	FRONT HEIGHT mm	LOAD CAPACITY kg	USABLE DIMENSIONS mm
F ST 8610 00 04	100	100	906x447x85 h

Extension (100%)

A maximum of 3 drawers can be fitted on each bay (or 6 if the load capacity is reduced to 50 Kg). The maximum permitted height for fitting drawers is 1000 mm.

■ 04
■ 08



Set of partitions see page A113

■ 04
■ 08

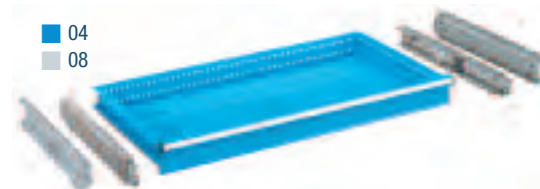

SHELVING SYSTEMS SYSTEM ST

PLAIN SIDE PANELS

ORD. NO.	FOR UPRIGHT FRAMES DIM. mm
F ST 2210 30 04	300x1000
F ST 2210 40 04	400x1000
F ST 2210 50 04	500x1000
F ST 2210 60 04	600x1000
F ST 2210 80 04	800x1000

ORD. NO.	FOR UPRIGHT FRAMES DIM. mm
F ST 2220 30 04	300x2000
F ST 2220 40 04	400x2000
F ST 2220 50 04	500x2000
F ST 2220 60 04	600x2000
F ST 2220 80 04	800x2000

ORD. NO.	FOR UPRIGHT FRAMES DIM. mm
F ST 2222 30 04	300x2200
F ST 2222 40 04	400x2200
F ST 2222 50 04	500x2200
F ST 2222 60 04	600x2200
F ST 2222 80 04	800x2200

ORD. NO.	FOR UPRIGHT FRAMES DIM. mm
F ST 2225 30 04	300x2500
F ST 2225 40 04	400x2500
F ST 2225 50 04	500x2500
F ST 2225 60 04	600x2500
F ST 2225 80 04	800x2500

ORD. NO.	FOR UPRIGHT FRAMES DIM. mm
F ST 2230 30 04	300x3000
F ST 2230 40 04	400x3000
F ST 2230 50 04	500x3000
F ST 2230 60 04	600x3000
F ST 2230 80 04	800x3000



- 04
- 08
- 99

The side panels are connected to the upright frame with proper clips and without screws.



ORD. NO. R FST 0001 99

Set of 4 spare galvanised clips for side panels

PERFORATED SIDE PANELS

ORD. NO.	FOR UPRIGHT FRAMES DIM. mm
F ST 2310 30 04	300x1000
F ST 2310 40 04	400x1000
F ST 2310 50 04	500x1000
F ST 2310 60 04	600x1000
F ST 2310 80 04	800x1000

ORD. NO.	FOR UPRIGHT FRAMES DIM. mm
F ST 2320 30 04	300x2000
F ST 2320 40 04	400x2000
F ST 2320 50 04	500x2000
F ST 2320 60 04	600x2000
F ST 2320 80 04	800x2000

ORD. NO.	FOR UPRIGHT FRAMES DIM. mm
F ST 2322 30 04	300x2200
F ST 2322 40 04	400x2200
F ST 2322 50 04	500x2200
F ST 2322 60 04	600x2200
F ST 2322 80 04	800x2200

ORD. NO.	FOR UPRIGHT FRAMES DIM. mm
F ST 2325 30 04	300x2500
F ST 2325 40 04	400x2500
F ST 2325 50 04	500x2500
F ST 2325 60 04	600x2500
F ST 2325 80 04	800x2500

ORD. NO.	FOR UPRIGHT FRAMES DIM. mm
F ST 2330 30 04	300x3000
F ST 2330 40 04	400x3000
F ST 2330 50 04	500x3000
F ST 2330 60 04	600x3000
F ST 2330 80 04	800x3000



- 04
- 08
- 99

The side panels are connected to the upright frame with proper clips and without screws.



ORD. NO. R FST 0001 99

Set of 4 spare galvanised clips for side panels



LENGTH = 800 / 1000 / 1250 mm

SHELVING SYSTEM SYSTEM ST

CONNECTING BAR BETWEEN SHELVING UNITS

■ 99



ORD. NO. GALVANISED	LENGTH mm
F ST 0820 00 99	800
F ST 0830 00 99	1000
F ST 0840 00 99	1250



Fitting the connection bar into the upright



AISLES:

If the layout of the shelving system includes aisles, metal or mesh panels must be fitted on all the sides that are not used for picking up or setting down the material. These aisles must have the following widths:

- Aisles used for manually picking up or setting down material from the shelving without drawers. Manually pushed trolleys may not be used: minimum width 800 mm.
- Aisles used for picking up or setting down material from the shelving through manually pushed trolleys (shelving system with or without drawers): minimum width 1250 mm.
- Aisles used for staff transit: minimum width 1250 mm.

Aisles used for picking up or setting down material cannot be used for staff transit. If aisles are required to be used for the transit of powered trolleys, please contact FAMI for further details.

Caution: for back to back shelving, back panels, mesh back panels or shelf stoppers must be mounted between the two shelving units in order to prevent the material stored on one side of the shelving from being accidentally pushed to the other side when material is being set down.

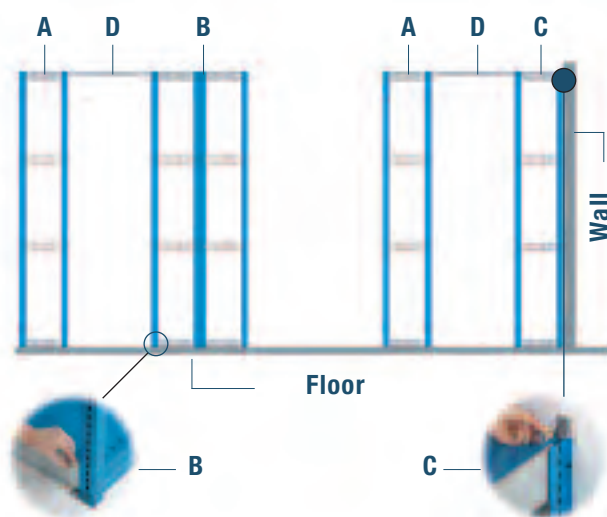
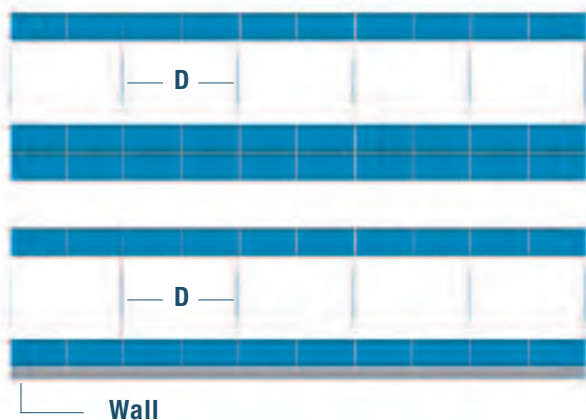

Caution: connection bars must be used for wall-fixed upright frames if these cannot be fixed to the wall. In this case the upright frame in question must be connected to a back to back upright frame which is either fixed to the floor or has one upright frame fixed to the wall.

To calculate the number of connection bars required to connect two shelving units, please see the above figure.

- The external upright frames must always be connected.
- The internal upright frames must be connected every two bays.

- A = Upright frame fixed with a connection bar.
- B = Back to back upright frames fixed to the floor.
- C = Single upright frame fixed to the wall.
- D = Upper safety connecting bar.

■ INFO

RAL 5012 F.04

RAL 7035 F.08

GALVANISEDF.99

www.famispa.com

SHELVING SYSTEMS SYSTEM ST

GUIDE RAILS FOR MULTIBOX



Assembling the guide rails for multibox



ORD. NO. GALVANISED	DEPTH OF SHELVING mm
F ST 9830 00 99	300
F ST 9840 00 99	400
F ST 9850 00 99	500
F ST 9860 00 99	600

■ Multibox
see page G42



SAFETY GUARDS FOR MULTIBOX BOXES

Made from galvanized sheet steel, the safety guards prevent the boxes from falling out by accident.

Assembling the safety guards



■ 99

ORD. NO. F ST 9996 00 99
Set of 2 galvanized safety pins to tighten the shelves.

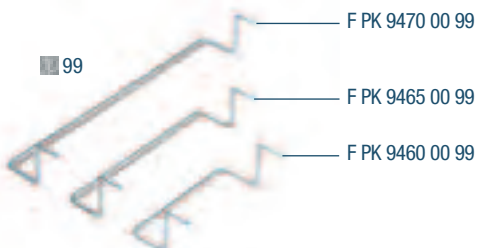

ORD. NO. GALVANISED	FOR BOXES	Ø mm
F PK 9460 00 99	F PK 0551 00 04	4.2
	F PK 1551 00 04	
	F PK 3051 00 04	
F PK 9465 00 99	F PK 1051 00 04	4.2
	F PK 2051 00 04	
	F PK 3551 00 04	
	F PK 4551 00 04	
F PK 9470 00 99	F PK 2551 00 04	4.2
	F PK 4051 00 04	



■ If Multibox containers are used with the shelving system, safety pins must be fitted on all the shelves in the system in order to prevent the upper shelf from coming loose if the Multibox is pushed down when open.

■ **Attention:** the strengthening bar can't be assembled on the shelves in which containers series multibox with safety guards are going to be inserted.

MULTIBOX

Standard colour:

■ BLUE F.04

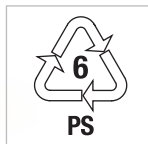

ORD. NO. GALVANISED	DIM. mm
F PK 0551 00 04	300x120x100 h
F PK 1551 00 04	400x120x100 h
F PK 3051 00 04	500x120x100 h

ORD. NO. GALVANISED	DIM. mm
F PK 1051 00 04	300x160x100 h
F PK 2051 00 04	400x160x100 h
F PK 3551 00 04	500x160x100 h
F PK 4551 00 04	600x160x100 h

ORD. NO. GALVANISED	DIM. mm
F PK 2551 00 04	400x240x100 h
F PK 4051 00 04	500x240x100 h

ORD. NO. F PK 9540 00 00

Quantity per sheet 12



ORD. NO. F PK 9580 00 00

Quantity per sheet 8



ORD. NO. F PK 9600 00 00

Quantity per sheet 6



PLAIN PARTITIONS FOR MULTIBOX

The plain partitions of transparent polystyrene are fitted with label holders and can divide the multibox from 2 to 11 compartments depending on the model.

Standard colour:

■ TRANSPARENT F.96

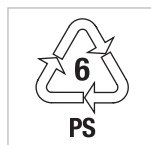
**PARTITION DIM. 100x90 mm h**

■ 96

ORD. NO.

F PK 7068 00 96

FOR BOXES

F PK 0551 00 04
F PK 1551 00 04
F PK 3051 00 04

PARTITION DIM. 145x90 mm h

■ 96

ORD. NO.

F PK 7368 00 96

FOR BOXES

F PK 1051 00 04
F PK 2051 00 04
F PK 3551 00 04
F PK 4551 00 04

PARTITION DIM. 225x90 mm h

■ 96

ORD. NO.

F PK 7668 00 96

FOR BOXES

F PK 2551 00 04
F PK 4051 00 04

MOBILE SAFETY LADDER

Standard colour:

■ GREY RAL 7000 F.01



■ 01

ORD. NO. F CR 0800 00 01

Upper tray.
Dim. mm 200x545x180 h



■ The mobile safety ladder is supplied standard with 4 rubber swivel wheels without brakes.

■ 01

ORD. NO. F CR 0300 00 01

Mobile safety ladder.
Load capacity 150 kg

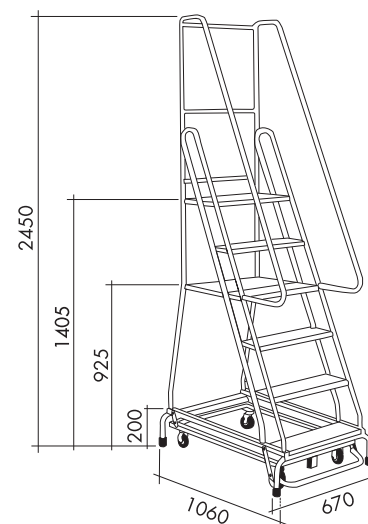

4 the ladder can now be moved.

1 Press down on the first step...

2 the mobile safety ladder lowers to its block position.

3 Press the release pedal...



SAFETY INFORMATION

WALL FIXING



When fixing shelving to the wall, one wall anchor with a force of **1.3 Kn** (including the safety coefficient) must be used for each upright frame.

FLOOR FIXING



When fixing shelving to the floor, one floor bolt with a force of **4.3 Kn** (including the safety coefficient) must be used for each foot plate.



LOAD TABLE AND LABEL



Example of a **standard** load label for shelves

A load table is supplied **standard** with each shelving system and a load label is provided with each shelf or drawer.

- The load table must be attached to a perfectly visible part of the shelving. It shows both the load capacity for each bay and the maximum permitted distance between shelves.
- The load label must be applied to the front of each shelf or drawer.

P.S.: the sum of the load capacities of the shelves in each single bay must never exceed the overall load capacity of the bay indicated in the table.

LOAD LABEL IN SCREEN-PRINTED ALUMINIUM

When ordering a F SV shelving system, a load table in screen-printed aluminium complete with tabs for attaching it to the shelving may also be ordered.



Screen-printed load table for front
ORD. NO. F SV 9998 00 00
Position of the front table



Screen-printed load table for sides
ORD. NO. F SV 9999 00 00
Position of the side table



INSTRUCTIONS HANDBOOK

A complete and detailed instructions handbook is supplied standard with the shelving system. This contains the following information:

- technical data
- intended use
- safety information and residue risk areas
- technical table for calculating the required floor strength
- installation and assembly instructions
- fixing instructions.



www.famispaspa.com

shelving system series	SV	Anno di costruzione	2002
Shelving type		Year of Manufacture	
Regal Serie		Herstellungsjahr	

Ordine n. / Order no. / Auftrag Nr.	12445
-------------------------------------	-------

Distanza massima tra i piani
Max. distance between shelves
Max. Abstand zwischen den Fachböden

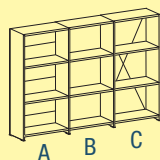
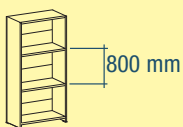

Portata per campata	
Max load capacity per bay	
Max. Tragfähigkeit pro Feld	
con parete posteriore	1000 Kg
A with back panel	
mit Rückwand	
libera	700 Kg
B free	
frei	
con crociera	700 Kg
C with cross bracing	
mit Kreuzverbund	

Carico uniformemente distribuito / Uniformly distributed load / Gleichmäßig verteilte Last

Example of a **standard** load table

LENGTH = 1000 / 1300 mm HEIGHT (H) = 2100 / 2350 / 2500 / 3100 mm h

SERIES SYSTEM SV-DUAL DOCS



FLOOR SET FIXING



Fixing material including no. 2 steel floor bolts M8x75 mm for uninterrupted concrete floors equal to or higher than class: B25 / RBK250 / MP. 25N for mm².

ORD. NO. F NC 8999 00 99



1000 mm long single bay complete with foot plates and Allen keys

Depth of bay mm	Height of bay mm	Number of compartments for fileholders	Number of shelves per bay	For fileholders height mm	ORD. NO.
600	2100	5x2	6	320/350	F SV A210 61 08
600	2350	6x2	7	320	F SV A235 61 08
600	2500	6x2	7	350	F SV A250 61 08
600	3100	8x2	9	320	F SV A310 61 08

1000 mm long add-on bay complete with foot plates and Allen keys

Depth of bay mm	Height of bay mm	Number of compartments for fileholders	Number of shelves per bay	For fileholders height mm	ORD. NO.
600	2100	5x2	6	320/350	F SV C210 61 08
600	2350	6x2	7	320	F SV C235 61 08
600	2500	6x2	7	350	F SV C250 61 08
600	3100	8x2	9	320	F SV C310 61 08

1300 mm long single bay complete with foot plates and Allen keys

Depth of bay mm	Height of bay mm	Number of compartments for fileholders	Number of shelves per bay	For fileholders height mm	ORD. NO.
600	2100	5x2	6	320/350	F SV F210 61 08
600	2350	6x2	7	320	F SV F235 61 08
600	2500	6x2	7	350	F SV F250 61 08
600	3100	8x2	9	320	F SV F310 61 08

1300 mm long add-on bay complete with foot plates and Allen keys

Depth of bay mm	Height of bay mm	Number of compartments for fileholders	Number of shelves per bay	For fileholders height mm	ORD. NO.
600	2100	5x2	6	320/350	F SV H210 61 08
600	2350	6x2	7	320	F SV H235 61 08
600	2500	6x2	7	350	F SV H250 61 08
600	3100	8x2	9	320	F SV H310 61 08

KEY



- Load capacity of each bay: **1000 kg**
- Load capacity of each shelf 1000 mm long: **120 kg**
- Load capacity of each shelf 1300 mm long: **100 kg**
- The shelving systems are supplied complete with foot plates and Allen key
- All indicated loads are net and refer to evenly distributed weights

Must be fixed to the floor

RAL 7035 F. 08

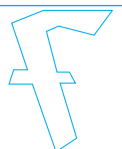

SHELVING SYSTEMS SYSTEM SV DOCS

LENGTH = 1000 / 1300 mm HEIGHT (H) = 2100 / 2350 / 2500 / 3100 mm h

SIDE PANELS

ORD. NO.	For upright frames dim. mm
F SV 2221 40 08	400x2100
F SV 2223 40 08	400x2350
F SV 2225 40 08	400x2500
F SV 2231 40 08	400x3100

WALL BRACKETS



Made from galvanised steel, they are fitted onto the top of the uprights. They are shaped to keep the shelving system at a distance of 15 mm from the wall. Available galvanised only.

ORD. NO. F ST 0710 00 99

FLOOR SET FIXING



Fixing material including no. 2 steel floor bolts M8x75 mm for uninterrupted concrete floors equal to or higher than class: B25 / RBK250 / MP_A 25N for mm².

ORD. NO. F NC 8999 00 99

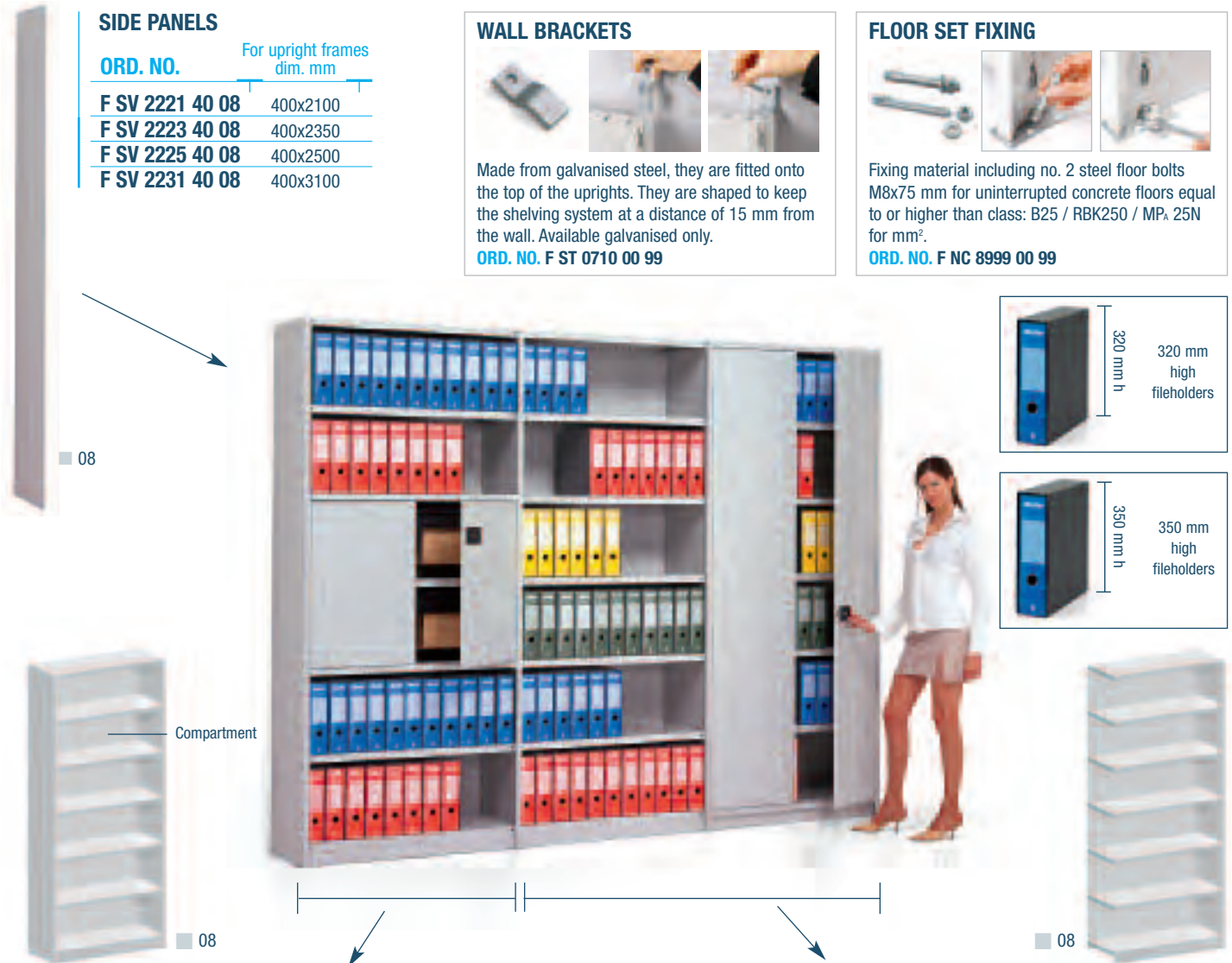

1000 mm long single bay complete with base plinth, back panel, foot plates, wall brackets and Allen keys

Depth of bay mm	Height of bay mm	Number of compartments for fileholders	Number of shelves per bay	For fileholders height mm	ORD. NO.
400	2100	5	6	320/350	F SV D210 41 08
400	2350	6	7	320	F SV D235 41 08
400	2500	6	7	350	F SV D250 41 08
400	3100	8	9	320	F SV D310 41 08

1000 mm long add-on bay complete with base plinth, back panel, foot plates, wall brackets and Allen keys

Depth of bay mm	Height of bay mm	Number of compartments for fileholders	Number of shelves per bay	For fileholders height mm	ORD. NO.
400	2100	5	6	320/350	F SV E210 41 08
400	2350	6	7	320	F SV E235 41 08
400	2500	6	7	350	F SV E250 41 08
400	3100	8	9	320	F SV E310 41 08

1300 mm long single bay complete with base plinth, back panel, foot plates, wall brackets and Allen keys

Depth of bay mm	Height of bay mm	Number of compartments for fileholders	Number of shelves per bay	For fileholders height mm	ORD. NO.
400	2100	5	6	320/350	F SV L210 41 08
400	2350	6	7	320	F SV L235 41 08
400	2500	6	7	350	F SV L250 41 08
400	3100	8	9	320	F SV L310 41 08

1300 mm long add-on bay complete with base plinth, back panel, foot plates, wall brackets and Allen keys

Depth of bay mm	Height of bay mm	Number of compartments for fileholders	Number of shelves per bay	For fileholders height mm	ORD. NO.
400	2100	5	6	320/350	F SV M210 41 08
400	2350	6	7	320	F SV M235 41 08
400	2500	6	7	350	F SV M250 41 08
400	3100	8	9	320	F SV M310 41 08

RAL 7035 F.08

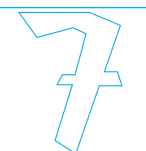

■ Load capacity of each bay: **1000 kg**

■ Load capacity of each shelf 1000 mm long: **120 kg**

■ Load capacity of each shelf 1300 mm long: **100 kg**

KEY ■

■ Must be fixed to the wall or floor

■ Must be fixed to the wall

■ All indicated loads are net and refer to evenly distributed weights



HEIGHT (H) = 320 / 350 mm

SHELVING SYSTEMS SYSTEM SV DOCS

LEAF DOORS



08

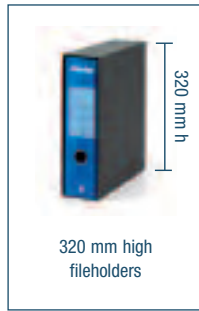

320 mm high fileholders



08

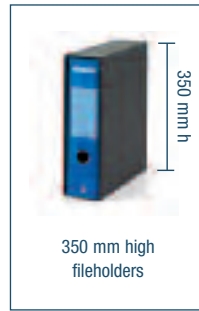

350 mm high fileholders



08

LEAF DOORS FOR 320/350 mm HIGH FILEHOLDERS

ORD. NO. DIM. LxH mm
F SV 5200 10 08 1000x2000

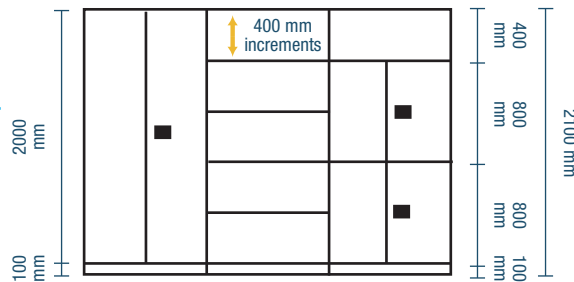

LEAF DOORS FOR 320/350 mm h HIGH FILEHOLDERS

ORD. NO. DIM. LxH mm
F SV 5080 10 08 1000x800

LEAF DOORS FOR 320 mm h HIGH FILEHOLDERS

ORD. NO. DIM. LxH mm
F SV 5225 10 08 1000x2250

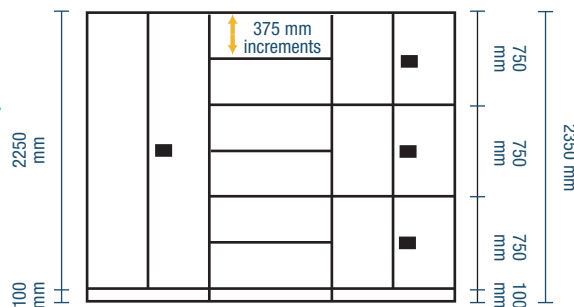

LEAF DOORS FOR 320 mm h HIGH FILEHOLDERS

ORD. NO. DIM. LxH mm
F SV 5075 10 08 1000x750

LEAF DOORS FOR 350 mm h HIGH FILEHOLDERS

ORD. NO. DIM. LxH mm
F SV 5200 10 08 1000x2000

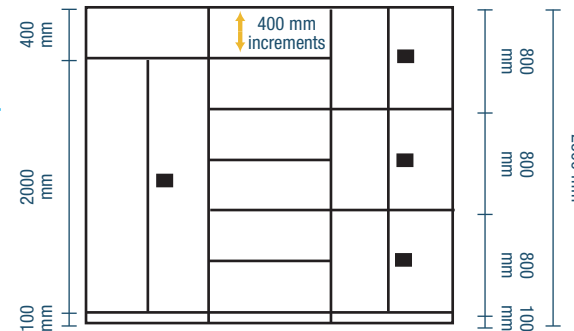

LEAF DOORS FOR 350 mm h HIGH FILEHOLDERS

ORD. NO. DIM. LxH mm
F SV 5080 10 08 1000x800

LEAF DOORS FOR 320 mm h HIGH FILEHOLDERS

ORD. NO. DIM. LxH mm
F SV 5225 10 08 1000x2250

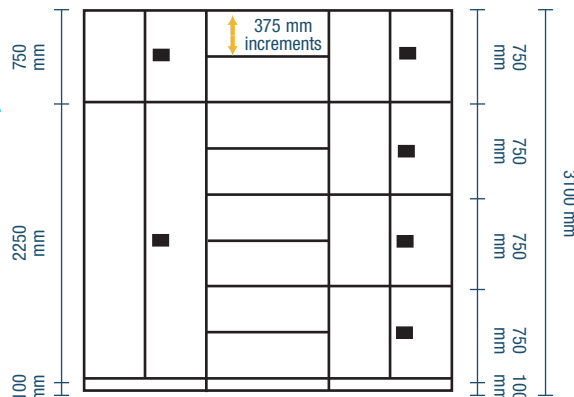

LEAF DOORS FOR 320 mm h HIGH FILEHOLDERS

ORD. NO. DIM. LxH mm
F SV 5075 10 08 1000x750

SHELVING SYSTEMS SYSTEM SV21

HEIGHT 2100 mm

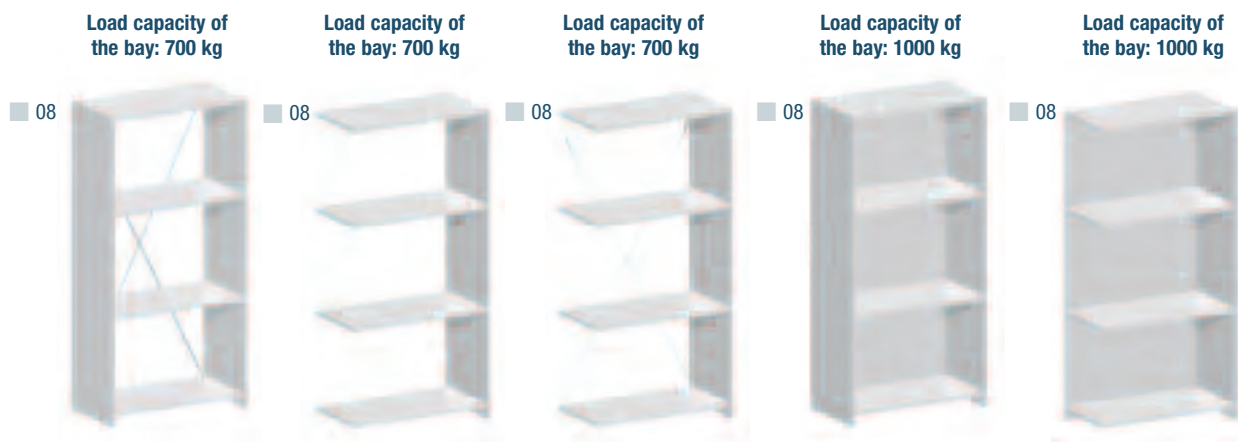

1000 mm LONG BAYS

Depth of bay mm	Single bay with cross bracing ORD. NO. galvanised	Add-on bay ORD. NO. galvanised	Add-on bay with cross bracing ORD. NO. galvanised	Single bay with back panel ORD. NO. galvanised	Add-on bay with back panel ORD. NO. galvanised
300	F SV A210 30 08	F SV B210 30 08	–	F SV D210 30 08	F SV E210 30 08
400	F SV A210 40 08	F SV B210 40 08	F SV C210 40 08	F SV D210 40 08	F SV E210 40 08
500	F SV A210 50 08	F SV B210 50 08	F SV C210 50 08	F SV D210 50 08	F SV E210 50 08
600	F SV A210 60 08	F SV B210 60 08	F SV C210 60 08	F SV D210 60 08	F SV E210 60 08

Each bay has 4 shelves. For 300 / 400 / 500 / 600 mm deep bays, the shelves are supplied without strengthening bars and have a load capacity of 120 kg.

1300 mm LONG BAYS

Depth of bay mm	Single bay with cross bracing ORD. NO. galvanised	Add-on bay ORD. NO. galvanised	Add-on bay with cross bracing ORD. NO. galvanised	Single bay with back panel ORD. NO. galvanised	Add-on bay with back panel ORD. NO. galvanised
300	F SV F210 30 08	F SV G210 30 08	–	F SV L210 30 08	F SV M210 30 08
400	F SV F210 40 08	F SV G210 40 08	F SV H210 40 08	F SV L210 40 08	F SV M210 40 08
500	F SV F210 50 08	F SV G210 50 08	F SV H210 50 08	F SV L210 50 08	F SV M210 50 08
600	F SV F210 60 08	F SV G210 60 08	F SV H210 60 08	F SV L210 60 08	F SV M210 60 08

Each bay has 4 shelves. For 300 / 400 / 500 / 600 mm deep bays, the shelves are supplied without strengthening bars and have a load capacity of 100 kg.

■ A cross bracing or a back panel must be fitted to each second bay (this does not apply to bays fixed to the wall)

■ For single shelving systems only single bays with cross bracings or back panels must be used.

FLOOR SET FIXING

Fixing material including no. 2 steel floor bolts M8x75 mm for uninterrupted concrete floors equal to or higher than class: B25 / RBK250 / MP_A 25N for mm².
ORD. NO. F NC 8999 00 99

WALL SET FIXING

■ All the bays which must be fixed to the wall are supplied standard with wall brackets.

FOOT PLATES FIXING

■ The single bays are supplied with an Allen key for fixing the foot plates.

RAL 7035 F. 08

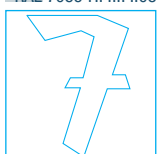

■ The bays are supplied unassembled complete with foot plates

■ Must be fixed to the floor or wall

KEY ■

- Must be fixed to the wall or floor
- Must be fixed to the wall

■ All indicated loads are net and refer to evenly distributed weights



LENGTH = 1000 / 1300 mm

SHELVING SYSTEMS SYSTEM SV23

HEIGHT 2350 mm

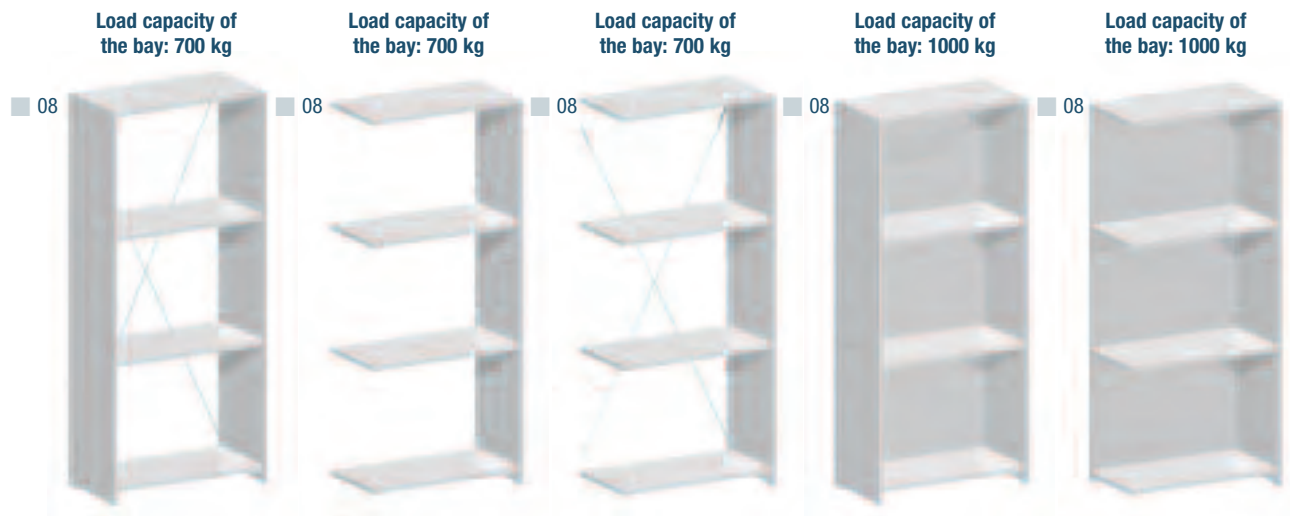

1000 mm LONG BAYS

Depth of bay mm	Single bay with cross bracing ORD. NO. galvanised	Add-on bay ORD. NO. galvanised	Add-on bay with cross bracing ORD. NO. galvanised	Single bay with back panel ORD. NO. galvanised	Add-on bay with back panel ORD. NO. galvanised
300	F SV A235 30 08	F SV B235 30 08	–	F SV D235 30 08	F SV E235 30 08
400	F SV A235 40 08	F SV B235 40 08	F SV C235 40 08	F SV D235 40 08	F SV E235 40 08
500	F SV A235 50 08	F SV B235 50 08	F SV C235 50 08	F SV D235 50 08	F SV E235 50 08
600	F SV A235 60 08	F SV B235 60 08	F SV C235 60 08	F SV D235 60 08	F SV E235 60 08

Each bay has 4 shelves. For 300 / 400 / 500 / 600 mm deep bays, the shelves are supplied without strengthening bars and have a load capacity of 120 kg.

1300 mm LONG BAYS

Depth of bay mm	Single bay with cross bracing ORD. NO. galvanised	Add-on bay ORD. NO. galvanised	Add-on bay with cross bracing ORD. NO. galvanised	Single bay with back panel ORD. NO. galvanised	Add-on bay with back panel ORD. NO. galvanised
300	F SV F235 30 08	F SV G235 30 08	–	F SV L235 30 08	F SV M235 30 08
400	F SV F235 40 08	F SV G235 40 08	F SV H235 40 08	F SV L235 40 08	F SV M235 40 08
500	F SV F235 50 08	F SV G235 50 08	F SV H235 50 08	F SV L235 50 08	F SV M235 50 08
600	F SV F235 60 08	F SV G235 60 08	F SV H235 60 08	F SV L235 60 08	F SV M235 60 08

Each bay has 4 shelves. For 300 / 400 / 500 / 600 mm deep bays, the shelves are supplied without strengthening bars and have a load capacity of 100 kg.

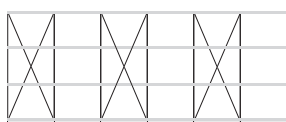

■ A cross bracing or a back panel must be fitted to each second bay (this does not apply to bays fixed to the wall)



■ For single shelving systems only single bays with cross bracings or back panels must be used.

FLOOR SET FIXING



Fixing material including no. 2 steel floor bolts M8x75 mm for uninterrupted concrete floors equal to or higher than class: B25 / RBK250 / MP_A 25N for mm².
ORD. NO. F NC 8999 00 99

WALL SET FIXING



■ All the bays which must be fixed to the wall are supplied standard with wall brackets.

FOOT PLATES FIXING



■ The single bays are supplied with an Allen key for fixing the foot plates.

KEY



Must be fixed to the wall or floor



Must be fixed to the wall

■ All indicated loads are net and refer to evenly distributed weights

■ Must be fixed to the floor or wall

■ The bays are supplied unassembled complete with foot plates

RAL 7035 F. 08



SHELVING SYSTEMS SYSTEM SV

UPRIGHT FRAMES 2100 / 2350 / 2500 / 3100 mm h

Made of cold-pressed sheet steel, they feature 2 rows of slots with 25 mm increments for fixing the shelves and a row of slots at the rear with 100 mm increments for fixing other structural elements such as back panels and cross bracings. The 600 mm deep frames feature a third row of slots in the middle for fixing the diagonal strengtheners used to retain the fileholders. Available in grey Ral 7035.

The upright frames are not supplied with foot plates.

FOOT PLATES

■ 99



■ **Attention:** 2 foot plates are required for each upright frame

■ They are pressed into the lower end of the uprights and fixed with a screw complete with washer and nut. Made from **galvanised sheet steel**.

ORD. NO. galvanised F SV 0700 00 99

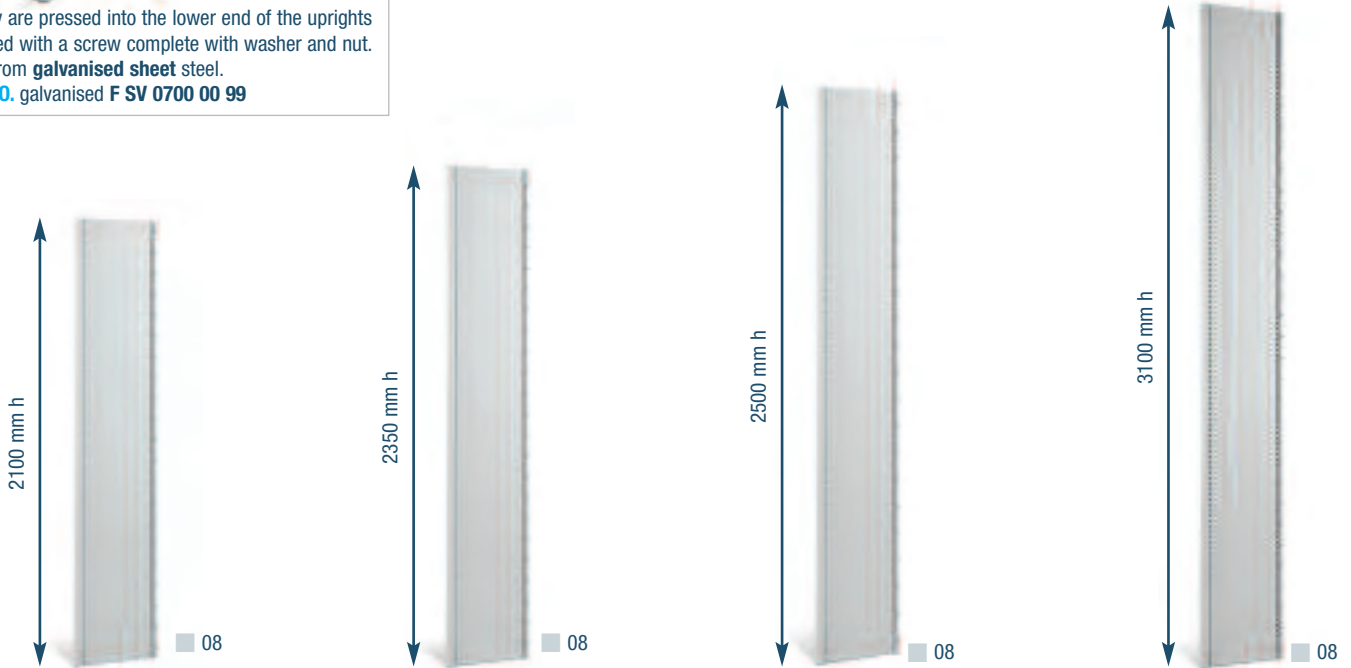

Depth of upright frame mm	ORD. NO.	Depth of upright frame mm	ORD. NO.	Depth of upright frame mm	ORD. NO.	Depth of upright frame mm	ORD. NO.
300	F SV 0210 30 08	300	F SV 0235 30 08	300	F SV 0250 30 08	300	F SV 0310 30 08
400	F SV 0210 40 08	400	F SV 0235 40 08	400	F SV 0250 40 08	400	F SV 0310 40 08
500	F SV 0210 50 08	500	F SV 0235 50 08	500	F SV 0250 50 08	500	F SV 0310 50 08
600	F SV 0210 60 08	600	F SV 0235 60 08	600	F SV 0250 60 08	600	F SV 0310 60 08

WALL BRACKETS



Made from galvanised steel, they are fitted to the top of the uprights. They are shaped to keep the shelving system at a distance of 15 mm from the wall. Available galvanised only.

ORD. NO. F ST 0710 00 99

FLOOR SET FIXING



Fixing material including no. 2 steel floor bolts M8x75 mm for uninterrupted concrete floors equal to or higher than class: B25 / RBK250 / MPa 25N for mm².

ORD. NO. F NC 8999 00 99

CONNECTION SET FOR BACK TO BACK UPRIGHT FRAMES



The clips are made of galvanised steel and are inserted into the rear of the upright frames. Each connection set includes 4 galvanised clips. **ORD. NO. F ST 0720 00 99**

RAL 7035 F.08

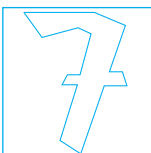

■ The upright frame **are not** supplied with foot plates

KEY ■



Must be fixed to the wall

This sign indicates that the upright frames have to be fixed to the wall by means of the fixing bracket ORD. NO. F ST 0710 00 99



LENGTH = 1000 / 1300 mm

SHELVING SYSTEMS SYSTEM SV



08

■ All indicated loads are net and refer to evenly distributed weights

1000 mm LONG SLOTTED SHELVES

ORD. NO.	DIMENSIONS mm	NUMBER OF BARS	LOAD CAPACITY kg
F SV 1030 00 08	1000x300x35 h	–	120
F SV 1040 00 08	1000x400x35 h	–	120
F SV 1040 01 08	1000x400x35 h	1	300
F SV 1050 00 08	1000x500x35 h	–	120
F SV 1050 01 08	1000x500x35 h	1	300
F SV 1050 02 08	1000x500x35 h	2	400
F SV 1060 00 08	1000x600x35 h	–	120
F SV 1060 01 08	1000x600x35 h	1	300
F SV 1060 02 08	1000x600x35 h	2	400

1300 mm LONG SLOTTED SHELVES

ORD. NO.	DIMENSIONS mm	NUMBER OF BARS	LOAD CAPACITY kg
F SV 1130 00 08	1300x300x35 h	–	100
F SV 1140 00 08	1300x400x35 h	–	100
F SV 1140 01 08	1300x400x35 h	1	230
F SV 1150 00 08	1300x500x35 h	–	100
F SV 1150 01 08	1300x500x35 h	1	230
F SV 1150 02 08	1300x500x35 h	2	300
F SV 1160 00 08	1300x600x35 h	–	100
F SV 1160 01 08	1300x600x35 h	1	200
F SV 1160 02 08	1300x600x35 h	2	300

■ All indicated loads are net and refer to evenly distributed weights

1000 mm LONG STRENGTHENING BAR



99

ORD. NO. R FST 0005 99

1300 mm LONG STRENGTHENING BAR



99

ORD. NO. R FST 0006 99

SPARE CLIPS FOR SHELVES



99

ORD. NO. R FST 0003 99

Set of 4 spare galvanised clips



99

ORD. NO. R FST 0002 99

Set of 2 double spare galvanised clips

MAGNETIC SUPPORT WITH LABEL



ORD. NO. F ST 9997 00 00

Magnetic support with label and cellophane

ORD. NO. R FST 0007 00

Spare label and cellophane (100 pcs)

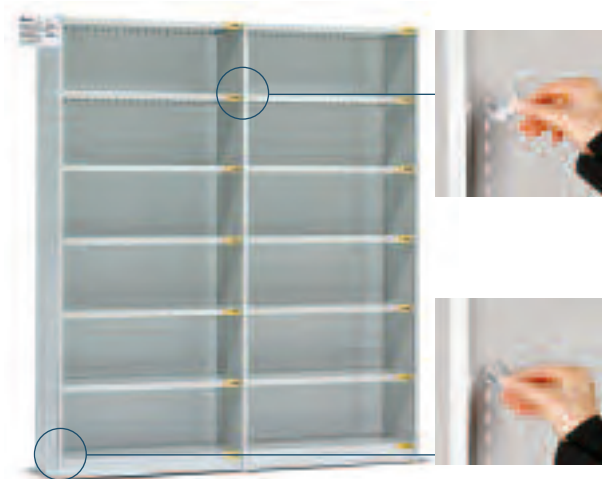

■ Attention:

all shelves are supplied with 2 double hooks and 4 single hooks



■ Shelves in this series are supplied with load labels



Assembling the strengthening bar and the shelf



Using the magnetic support with label

SHELVING SYSTEMS SYSTEM SV

BASE PLINTHS



■ 08

ORD. NO.

LENGTH mm

F ST 7510 00 08

1000

F ST 7520 00 08

1300

The base plinths are used to close the lower part of the shelving. They are assembled without screws and are available in two lengths: 1000 mm and 1300 mm. **Available grey Ral 7035.**

Assembling the base plinth



LEAF DOORS

Each pair of leaf doors closes 1 bay. Available for 1000 mm long bays, they are easy to be assembled (just 4 screws are used for a pair of doors). The doors are supplied with a safety lock and 2 keys. **Available grey Ral 7035.**



■ 08

FOOT PLATES FIXING



■ Allen key supplied standard



■ 08

ORD. NO.

DIMENSIONS LxH mm

F SV 5200 10 08

1000x2000 h

F SV 5225 10 08

1000x2250 h

ORD. NO.

DIMENSIONS LxH mm

F SV 5075 10 08

1000x750 h

F SV 5080 10 08

1000x800 h



■ This type of door closes 1 bay

PLAIN SIDE PANELS

The side panels are connected to the upright frame with proper clips and without screws. **Available in grey Ral 7035.**



■ 08

ORD. NO.

FOR UPRIGHT FRAMES DIM. mm

F SV 2221 30 08

300x2100 h

F SV 2221 40 08

400x2100 h

F SV 2221 50 08

500x2100 h

F SV 2221 60 08

600x2100 h

F SV 2223 30 08

300x2350 h

F SV 2223 40 08

400x2350 h

F SV 2223 50 08

500x2350 h

F SV 2223 60 08

600x2350 h

F SV 2225 30 08

300x2500 h

F SV 2225 40 08

400x2500 h

F SV 2225 50 08

500x2500 h

F SV 2225 60 08

600x2500 h

F SV 2231 30 08

300x3100 h

F SV 2231 40 08

400x3100 h

F SV 2231 50 08

500x3100 h

F SV 2231 60 08

600x3100 h

Assembling the side panel



SET OF 4 SPARE GALVANISED CLIPS FOR SIDE PANEL

ORD. NO. R SV 0001 99



LENGTH = 1000 / 1300 mm

SHELVING SYSTEMS SYSTEM SV

CROSS BRACINGS

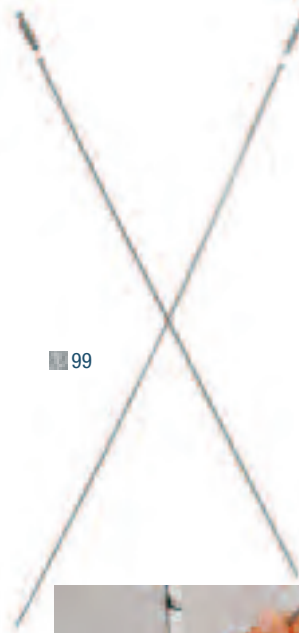

■ 99

Assembling the cross bracing

ORD. NO. GALVANISED	DIM. PER BAY mm	DIM. LxH mm
F ST 7120 00 99	1000x2100	1000x2000
F ST 7122 00 99	1000x2350	1000x2200
F ST 7125 00 99	1000x2500	1000x2500
F ST 7220 00 99	1300x2100	1300x2000
F ST 7222 00 99	1300x2350	1300x2200
F ST 7225 00 99	1300x2500	1300x2500

The cross bracing is attached to the shelving from the front side without using screws. This system makes assembly easy especially if the shelving is positioned against the wall. **Available galvanised.**

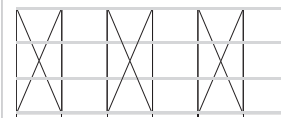

■ A cross bracing must be fitted to each second bay



■ A cross bracing must always be fitted to the single shelving system

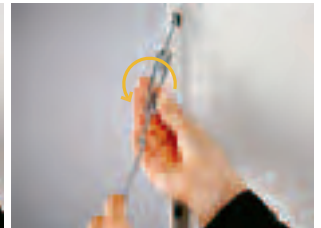

BACK PANELS



■ 08



Assembling the back panel

The back panels are also attached to the shelving from the front. No screws are used. This system makes assembly easy especially if the shelving is positioned against the wall. Supplied in various sections depending on the height of the shelving. **Available grey Ral 7035.**

ORD. NO.	DIM. LxH mm
F SV 2021 10 08	1000x2100
F SV 2023 10 08	1000x2350
F SV 2025 10 08	1000x2500
F SV 2031 10 08	1000x3100
F SV 2021 13 08	1300x2100
F SV 2023 13 08	1300x2350
F SV 2025 13 08	1300x2500
F SV 2031 13 08	1300x3100



■ A back panel must always be fitted to the single shelving system

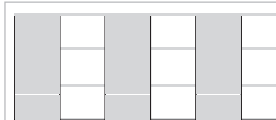

■ A back panel must be fitted, at least every second bay, on those shelvings with a height from 2100 mm to 2500 mm

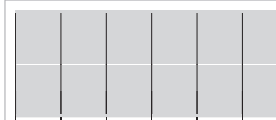

■ A back panel must be fitted on each bay if the shelving is 3100 mm



FULL EXTENSION SUSPENSION FOLDER FRAME FOR SUSPENSION FOLDER DIN A4

The suspension folder frames are supplied with full extension guide rails (100% extraction) with 30 Kg load capacity. Overall dimensions 990x400 mm. To insert the frame complete with suspension folders, make sure there is a minimum increment of 375 mm between shelves. **The frames can only be used for 1000 mm long and 400 mm deep bays.** Available in black Ral 9011.

■ 07



ORD. NO. F SV 7840 07



SHELVING SYSTEMS SYSTEM SV

SHELF DIVIDERS

The shelf dividers are fitted into the shelf slots. They have a **standard height of 100 mm** and are supplied **galvanised**.

■ 99



ORD. NO. GALVANISED	DEPTH OF SHELVING mm
F ST 9230 00 99	300
F ST 9240 00 99	400
F ST 9250 00 99	500
F ST 9260 00 99	600



Assembling a shelf divider



SHELF PANELS

The shelf panels are fitted into the slots between two shelves. They are available **galvanised** and in various heights ranging from 165 to 415 mm and in 4 different depths.

■ 99

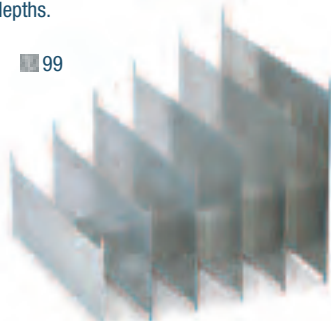

Assembling a shelf panel



Distance between shelves

Space between shelves

Space between shelves mm	Distance between shelves mm	Depth of shelving unit 300 mm ORD. NO. galvanised	Depth of shelving unit 400 mm ORD. NO. galvanised	Depth of shelving unit 500 mm ORD. NO. galvanised	Depth of shelving unit 600 mm ORD. NO. galvanised
165	200	F ST 9000 00 99	F ST 9030 00 99	F ST 9060 00 99	F ST 9090 00 99
215	250	F ST 9005 00 99	F ST 9035 00 99	F ST 9065 00 99	F ST 9095 00 99
265	300	F ST 9010 00 99	F ST 9040 00 99	F ST 9070 00 99	F ST 9100 00 99
315	350	F ST 9015 00 99	F ST 9045 00 99	F ST 9075 00 99	F ST 9105 00 99
365	400	F ST 9020 00 99	F ST 9050 00 99	F ST 9080 00 99	F ST 9110 00 99
415	450	F ST 9025 00 99	F ST 9055 00 99	F ST 9085 00 99	F ST 9115 00 99

DEPTH = 300 / 400 / 500 / 600 mm

SHELVING SYSTEMS SYSTEM SV

SET OF TROUGH PANELS AND TAPERED TROUGH DIVIDERS

Both trough panels are slotted in 50 mm increments to fit the tapered dividers. Assembly is quick and easy. **No screws are used.** The trough panels are available **grey Ral 7035**, while the tapered dividers are available **galvanised**.



■ 55



■ 99

SET OF TROUGH PANELS WITH TWO TAPERED TROUGH DIVIDERS FOR 1000 mm LONG SHELVES

ORD. NO.	DEPTH mm
F ST 9510 30 55	300
F ST 9510 40 55	400
F ST 9510 50 55	500
F ST 9510 60 55	600

SET OF TROUGH PANELS WITH TWO TAPERED TROUGH DIVIDERS FOR 1300 mm LONG SHELVES

ORD. NO.	DEPTH mm
F ST 9520 30 55	300
F ST 9520 40 55	400
F ST 9520 50 55	500
F ST 9520 60 55	600

ADDITIONAL TAPERED TROUGH DIVIDER

ORD. NO.	DEPTH mm
F ST 9630 00 99	300
F ST 9640 00 99	400
F ST 9650 00 99	500
F ST 9660 00 99	600

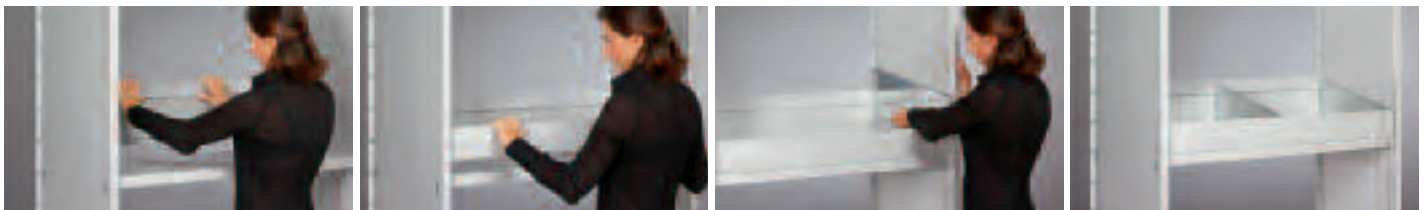

Assembling the trough panels and the tapered trough dividers

CONNECTING BAR BETWEEN SHELVING UNITS

■ 99



ORD. NO. GALVANISED	LENGTH mm
F SV 0820 00 99	800
F SV 0830 00 99	1000
F SV 0840 00 99	1250

AISLES:

If the layout of the shelving system includes aisles, metal or mesh panels must be fitted on all the sides that are not used for picking up or setting down the material. These aisles must have the following widths:

- Aisles used for manually picking up or setting down material from the shelving without drawers. Manually pushed trolleys may not be used: minimum width 800 mm.
- Aisles used for picking up or setting down material from the shelving through manually pushed trolleys (shelving system with or without drawers): minimum width 1250 mm.
- Aisles used for staff transit: minimum width 1250 mm.

Aisles used for picking up or setting down material cannot be used for staff transit. If aisles are required to be used for the transit of powered trolleys, please contact FAMI for further details.

Caution: for back to back shelving, back panels, mesh back panels or shelf stoppers must be mounted between the two shelving units in order to prevent the material stored on one side of the shelving from being accidentally pushed to the other side when material is being set down.

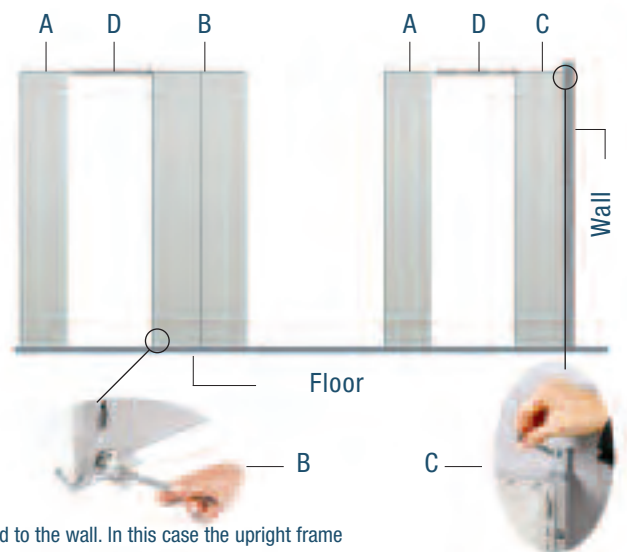
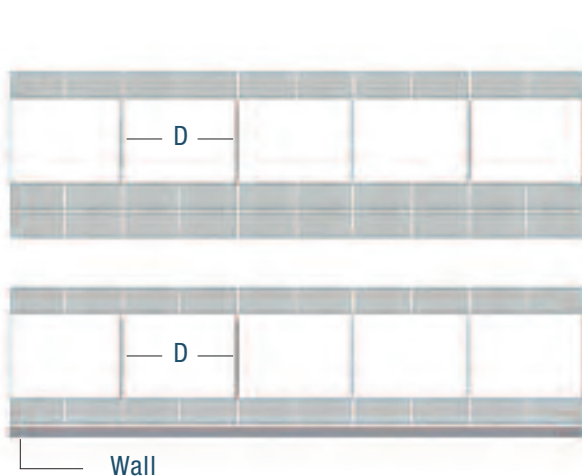

Caution: connection bars must be used for wall-fixed upright frames if these cannot be fixed to the wall. In this case the upright frame in question must be connected to a back to back upright frame which is either fixed to the floor or has one upright frame fixed to the wall.

To calculate the number of connection bars required to connect two shelving units, please see the above figure.

- The external upright frames must always be connected.
- The internal upright frames must be connected every two bays.

- A = Upright frame fixed with a connection bar.
- B = Back to back upright frames fixed to the floor.
- C = Single upright frame fixed to the wall.
- D = Upper safety connecting bar.

SHELVING SYSTEMS SYSTEM SV

GUIDE RAILS FOR MULTIBOX



Assembling the guide rails for multibox



ORD. NO. GALVANISED	DEPTH OF SHELVING mm
F ST 9830 00 99	300
F ST 9840 00 99	400
F ST 9850 00 99	500
F ST 9860 00 99	600

■ Multibox
see page G42



SAFETY GUARDS FOR MULTIBOX BOXES

Made from galvanized sheet steel, the safety guards prevent the boxes from falling out by accident.

Assembling the safety guards



■ 99

ORD. NO. F ST 9996 00 99
Set of 2 galvanized safety pins to tighten the shelves.

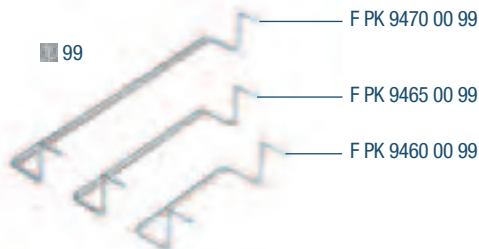

ORD. NO. GALVANISED	FOR BOXES	Ø mm
F PK 9460 00 99	F PK 0551 00 04	4,2
	F PK 1551 00 04	
	F PK 3051 00 04	
F PK 9465 00 99	F PK 1051 00 04	4,2
	F PK 2051 00 04	
	F PK 3551 00 04	
	F PK 4551 00 04	
F PK 9470 00 99	F PK 2551 00 04	4,2
	F PK 4051 00 04	



■ If Multibox containers are used with the shelving system, safety pins must be fitted on all the shelves in the system in order to prevent the upper shelf from coming loose if the Multibox is pushed down when open.

■ **Attention:** the strengthening bar can't be assembled on the shelves in which containers series multibox with safety guards are going to be inserted.

MULTIBOX

Standard colour:

■ BLUE F.04

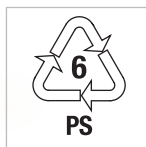

ORD. NO. GALVANISED	DIM. mm
F PK 0551 00 04	300x120x100 h
F PK 1551 00 04	400x120x100 h
F PK 3051 00 04	500x120x100 h

ORD. NO. GALVANISED	DIM. mm
F PK 1051 00 04	300x160x100 h
F PK 2051 00 04	400x160x100 h
F PK 3551 00 04	500x160x100 h
F PK 4551 00 04	600x160x100 h

ORD. NO. GALVANISED	DIM. mm
F PK 2551 00 04	400x240x100 h
F PK 4051 00 04	500x240x100 h

ORD. NO. F PK 9540 00 00

Quantity per sheet 12



ORD. NO. F PK 9580 00 00

Quantity per sheet 8



ORD. NO. F PK 9600 00 00

Quantity per sheet 6



DEPTH = 300 / 400 / 500 / 600 mm

SHELVING SYSTEMS SYSTEM SV

PLAIN PARTITIONS FOR MULTIBOX

The plain partitions of transparent polystyrene are fitted with label holders and can divide the multibox from 2 to 11 compartments depending on the model.



Standard colour:

■ TRANSPARENT F. 96



PARTITION DIM. 100x90 mm h



■ 96

ORD. NO.

FOR BOXES

F PK 7068 00 96

F PK 0551 00 04
F PK 1551 00 04
F PK 3051 00 04

PARTITION DIM. 145x90 mm h



■ 96

ORD. NO.

FOR BOXES

F PK 7368 00 96

F PK 1051 00 04
F PK 2051 00 04
F PK 3551 00 04
F PK 4551 00 04

PARTITION DIM. 225x90 mm h



■ 96

ORD. NO.

FOR BOXES

F PK 7668 00 96

F PK 2551 00 04
F PK 4051 00 04

MOBILE SAFETY LADDER

Standard colour:

■ GREY RAL 7000 F. 01



■ 01

ORD. NO. F CR 0800 00 01

Upper tray.
Dim. mm 200x545x180 h



■ The mobile safety ladder is supplied standard with 4 rubber swivel wheels without brakes.

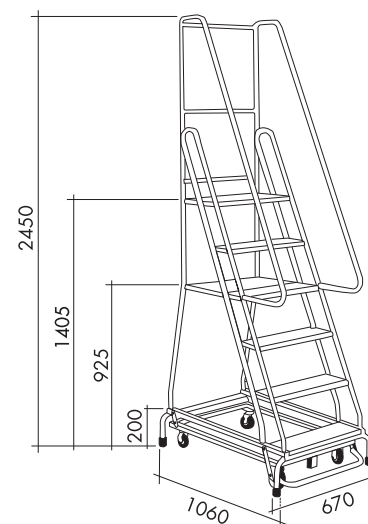

ORD. NO. F CR 0300 00 01

Mobile safety ladder.
Load capacity 150 kg

4 the ladder can now be moved.

1 Press down on the first step...

2 the mobile safety ladder lowers to its block position.

3 Press the release pedal...



SHELVING SYSTEM SYSTEM AR

SAFETY

DOUBLE LOCKING SAFETY MECHANISM

The shelving system is fitted with a double locking system to allow only one shelf to be pulled out at one time. The anti-tilt system is based on a bar with safety catches fitted to each upright. Each shelf is fitted with an individual safety catch. The anti-tilt system prevents the movement of any stored items.



RETRACTABLE SHELF CATCH

The safety catch locks the shelf into normal or retracted position. This feature prevents the movement of the shelf during handling of stored items.



catch for normal extension shelves



catch for full extension shelves

FLOOR SUPPORT PLATE

The floor support plate distributes the weight pressure imposed by the upright onto the floor surface. A technical chart showing flooring and surface requirements is supplied by FAMI.

The floor support plate has a fixing hole to allow anchorage to the floor with raw bolts supplied as standard. "Floor fixing" forms part of the basic safety requirements.

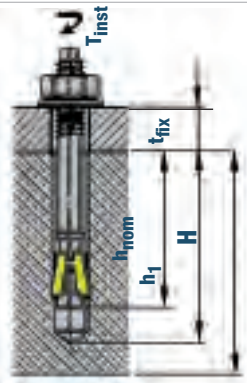

Recommended raw bolt tension ... 11,65 KN	Min. surface thickness for raw bolt fixing * H: 160 mm
Raw bolt diameter Ø 16 mm	Min. distance of raw bolt from surface edge B: 175 mm
Hole diameter in concrete Ø 16 mm	Raw bolt influence area or centre distance ** A: 112,5 mm
Minimum hole depth h ₁ : 115 mm	Min. dist. of upright from surface edge C: 75 mm
Minimum fitting depth h _{nom} : 95 mm	
Max fixable thickness t _{fix} : 25 mm	
Max torque setting T _{inst} : 125 NM	

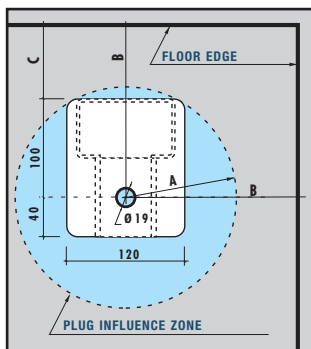

* It is compulsory that the floor surface has sufficient strength to maintain the shelving weight and floor pressure. The surface must be of sufficient strength to allow for raw bolts to be fitted to the floor.
 ** The area must remain free of any other force.

SHELF LOAD CAPACITY

A label stating load capacity for evenly distributed weight is fitted to each shelf.

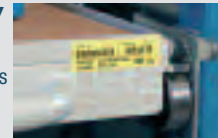

Example of retractable shelf load label supplied as standard

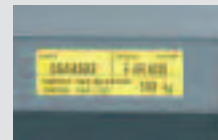

Example of top shelf load label supplied as standard

LOAD CAPACITY PER SINGLE BAY

The shelving system is supplied with a weight loading table to ensure correct loading.

The table indicates:

- the type of shelving
- the year of manufacture
- manufacturer's internal reference number
- load capacity per bay excluding bay weight.



Example of a standard load table

INSTRUCTIONS HANDBOOK

A complete and detailed instructions handbook is supplied standard with the shelving system. This contains the following information:

- technical data
- intended use
- safety information and residue risk areas
- technical table for calculating the required floor strength
- installation and assembly instructions
- fixing instructions.



TECHNICAL DATA

SHELVING SYSTEM SYSTEM AR

NORMAL EXTENSION

A: Shelving depth	900, 1100, 1300 mm
B: Bay width	1250 mm
C: Retractable extension	600, 750, 900 mm
D: Upright width	100 mm
E: Shelving height	1510, 2010, 2210, 2510, 3010 mm
F: Top shelf	50 mm
G: Adjustable pitch	50 mm
H: Retractable shelf thickness	58 mm
I: Min. distance from the floor	185 mm
L: Min. distance between shelves	300 mm
M: Min. span between shelves	225 mm
N: Foot plate	120 mm
O: Min. distance from top shelf	175 mm
R: Encumbrance	60 mm
Upright sheet steel thickness	3 mm

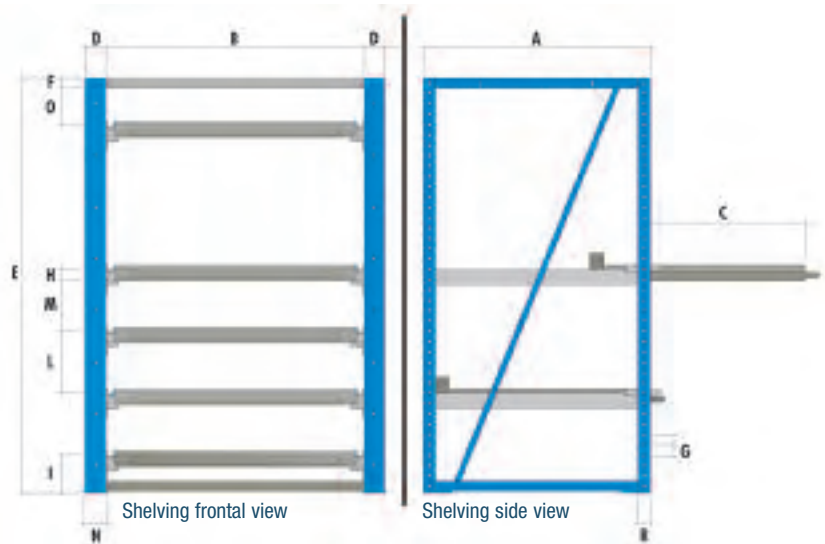

FULL EXTENSION

A: Shelving depth	900, 1100, 1300 mm
B: Bay width	850, 1050, 1250 mm
C: Retractable extension	770, 970, 1170 mm
D: Upright width	100 mm
E: Shelving height	1510, 2010, 2210, 2510, 3010 mm
F: Top shelf	50 mm
G: Adjustable pitch	50 mm
H: Retractable shelf thickness	107 mm
I: Min. distance from the floor	285 mm
L: Min. distance between shelves	300 mm
M: Min. span between shelves	190 mm
N: Foot plate	120 mm
O: Min. distance from top shelf	50 mm
P: Slide height	80 mm
Q: Slide width	100 mm
R: Encumbrance	60 mm
Upright sheet steel thickness	3 mm

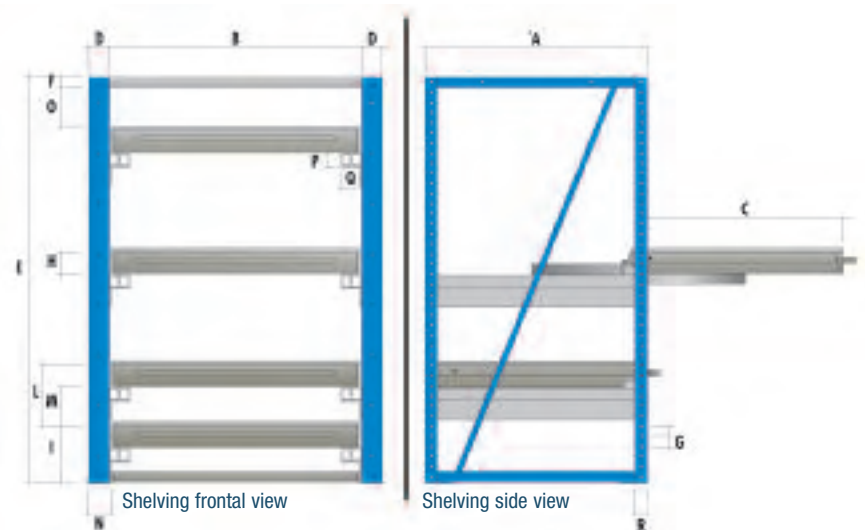

■ Combination of standard colours



blue RAL 5012 + grey RAL 7000

■ 51



green RAL 6011

■ 02

LOAD CAPACITY

- Single bay load capacity:..... 5000 Kg
- Full extension retractable shelf load capacity:..... 1000 Kg
- Normal extension retractable shelf load capacity:..... 800 Kg
- Top shelf load capacity for 900 mm depth:..... 300 Kg
- Top shelf load capacity for 1100 mm depth:..... 250 Kg
- Top shelf load capacity for 1300 mm depth:..... 200 Kg

EXTRA FIXING SET FOR ONE UPRIGHT



Fixing material including no. 2 steel floor bolts M16x140 mm for uninterrupted concrete floors equal to or higher than class: B25 / RBK250 / MPa 25N for mm².

ORD. NO. F AR 8999 00 99

■ KEY

■ RAL 5012 +
RAL 7000 F. 51 ■ RAL 6011 F. 02



- All indicated loads are net and refer to evenly distributed weights

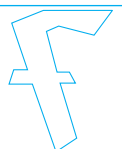

SHELVING SYSTEM SYSTEM AR

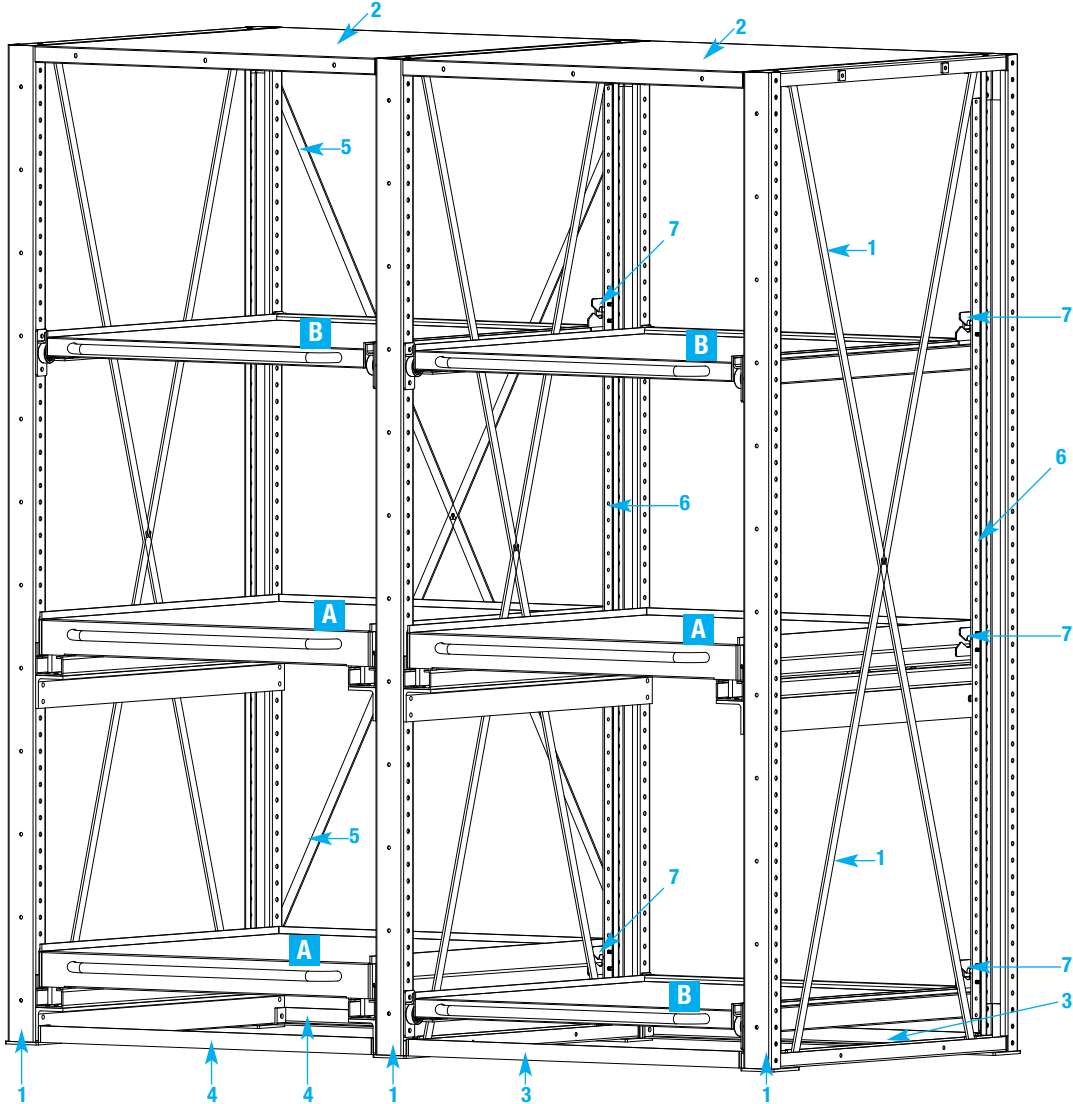

A
Full extension shelf see page F38-F39

B
Normal extension shelf see page F40

1 UPRIGHTS ■ 02 ■ 04

ORD. NO.	HEIGHT mm	DEPTH mm
F AR 2050 00 04	1510	900
F AR 2060 00 04	2010	
F AR 2070 00 04	2210	
F AR 2080 00 04	2510	
F AR 2090 00 04	3010	
F AR 2100 00 04	1510	
F AR 2110 00 04	2010	1100
F AR 2120 00 04	2210	
F AR 2130 00 04	2510	
F AR 2140 00 04	3010	
F AR 2150 00 04	1510	
F AR 2160 00 04	2010	
F AR 2170 00 04	2210	1300
F AR 2180 00 04	2510	
F AR 2190 00 04	3010	

Fixing materials composed by 2 expanding steel screws M16x140 supplied as standard. Bays supplied unassembled.

2 TOP SHELVES ■ 01 ■ 02

ORD. NO.	LOAD CAPACITY kg	DIMENSIONS mm
F AR 4020 00 01	300	850x900x50 h
F AR 4030 00 01	250	850x1100x50 h
F AR 4040 00 01	200	850x1300x50 h
F AR 4120 00 01	300	1050x900x50 h
F AR 4130 00 01	250	1050x1100x50 h
F AR 4140 00 01	200	1050x1300x50 h
F AR 4220 00 01	300	1250x900x50 h
F AR 4230 00 01	250	1250x1100x50 h
F AR 4240 00 01	200	1250x1300x50 h

■ The shelves in this series are supplied with load labels.



EXTRA FIXING SET FOR ONE UPRIGHT

Fixing material including no. 2 steel floor bolts M16x140 mm for uninterrupted concrete floors equal to or higher than class: B25 / RBK250 / MP_A 25N for mm².

ORD. NO. F AR 8999 00 99

RAL 7000 F.01 ■ RAL 6011 F.02 ■ RAL 5012 F.04 ■



KEY ■

- Spare fixing set for one upright see page F35
- All indicated loads are net and refer to evenly distributed weights



DEPTH = 900 / 1100 / 1300 mm

SHELVING SYSTEM SYSTEM AR

3 HORIZONTAL DISTANCE TIE BARS FOR NORMAL EXTENSION SHELVES

ORD. NO.	BAY WIDTH mm
F AR 1040 00 01	1250

2 bars for each bay are needed



■ 01 ■ 02

4 HORIZONTAL DISTANCE TIE BARS FOR FULL EXTENSION SHELVES

ORD. NO.	BAY WIDTH mm
F AR 1010 00 01	850
F AR 1020 00 01	1050
F AR 1030 00 01	1250

2 bars for each bay are needed



■ 01 ■ 02

5 CROSS BRACING

ORD. NO.	HEIGHT UPRIGHT mm	BAY WIDTH mm
F AR 1850 00 01	1510	850
F AR 1860 00 01	2010	
F AR 1870 00 01	2210	
F AR 1880 00 01	2510	
F AR 1890 00 01	3010	
F AR 1900 00 01	1510	1050
F AR 1910 00 01	2010	
F AR 1920 00 01	2210	
F AR 1930 00 01	2510	
F AR 1940 00 01	3010	1250
F AR 1950 00 01	1510	
F AR 1960 00 01	2010	
F AR 1970 00 01	2210	
F AR 1980 00 01	2510	
F AR 1990 00 01	3010	

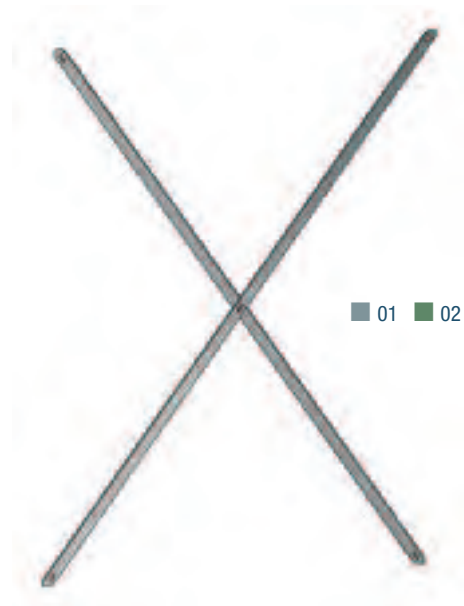

■ 01 ■ 02

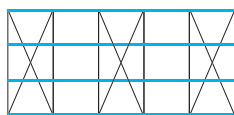

■ A cross bracing must be fitted to each second bay

SINGLE DRAWER OPENING SYSTEM

The single drawer opening system forms a standard part of this shelving system. The system prevents the operator from retracting more than one shelf at one time. The system comprises a locking bar as the same height of the upright and one locking catch per retractable shelf. Each bay requires one locking bar and one safety catch per retractable shelf (**hooks are standard supplied with the retractable shelf**).

Standard colours grey Ral 7000 or green Ral 6011.

6 BAR

ORD. NO.	UPRIGHT HEIGHT mm
F AR 1100 00 01	1510
F AR 1110 00 01	2010
F AR 1120 00 01	2210
F AR 1130 00 01	2510
F AR 1140 00 01	3010



■ 01 ■ 02

7 LOCKING CATCH

■ Locking catch are standard supplied with the retractable shelf

■ INFO

RAL 7000 F.01 RAL 6011 F.02



www.famispaspa.com

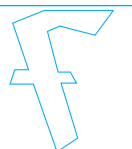

SHELVING SYSTEM SYSTEM AR

A FULL EXTENSION SHELVES WITH 3 EDGES

FOR BAY 850 mm WIDTH

ORD. NO.	Bay width mm	Shelf depth mm	Usable width mm	Usable depth mm	Extension mm
F AR 7400 00 01	850	900	805	845	770
F AR 7410 00 01	850	1100	805	1045	970
F AR 7420 00 01	850	1300	805	1245	1170

Load capacity: 1000 kg

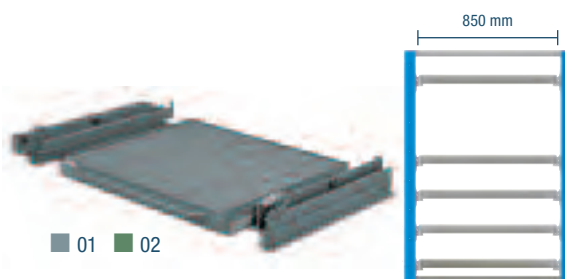

FOR BAY 1050 mm WIDTH

ORD. NO.	Bay width mm	Shelf depth mm	Usable width mm	Usable depth mm	Extension mm
F AR 7500 00 01	1050	900	1005	845	770
F AR 7510 00 01	1050	1100	1005	1045	970
F AR 7520 00 01	1050	1300	1005	1245	1170

Load capacity: 1000 kg

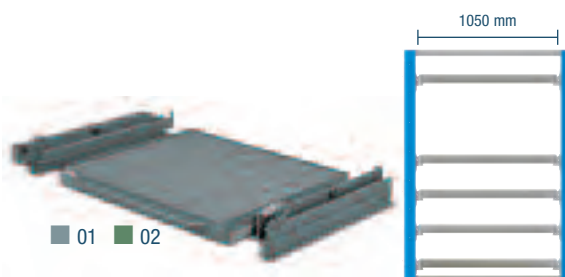

FOR BAY 1250 mm WIDTH

ORD. NO.	Bay width mm	Shelf depth mm	Usable width mm	Usable depth mm	Extension mm
F AR 7600 00 01	1250	900	1205	845	770
F AR 7610 00 01	1250	1100	1205	1045	970
F AR 7620 00 01	1250	1300	1205	1245	1170

Load capacity: 1000 kg

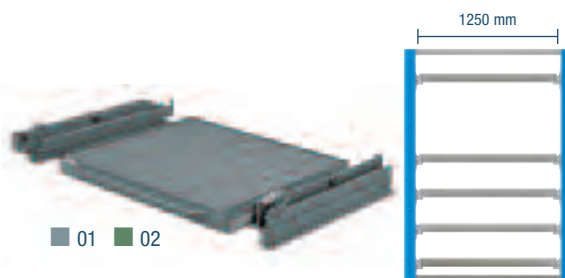

■ The extension shelves in this series are supplied with **load labels**.



RAL 7000 F.01 RAL 6011 F.02

KEY ■

■ All indicated loads are net and refer to evenly distributed weights

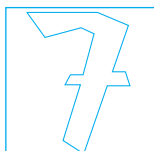

FOR BAY 850 / 1050 / 1250 mm WIDTH

SHELVING SYSTEM SYSTEM AR

A FULL EXTENSION SHELVES WITH 4 EDGES

FOR BAY 850 mm WIDTH

ORD. NO.	Bay width mm	Shelf depth mm	Usable width mm	Usable depth mm	Extension mm
F AR 7450 00 01	850	900	805	845	770
F AR 7460 00 01	850	1100	805	1045	970
F AR 7470 00 01	850	1300	805	1245	1170

Load capacity: 1000 kg

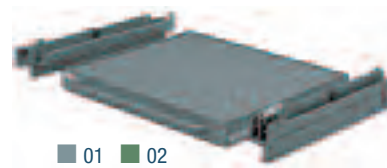

FOR BAY 1050 mm WIDTH

ORD. NO.	Bay width mm	Shelf depth mm	Usable width mm	Usable depth mm	Extension mm
F AR 7550 00 01	1050	900	1005	845	770
F AR 7560 00 01	1050	1100	1005	1045	970
F AR 7570 00 01	1050	1300	1005	1245	1170

Load capacity: 1000 kg

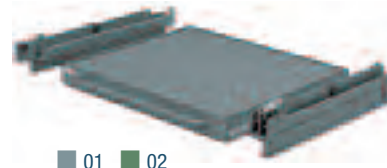

FOR BAY 1250 mm WIDTH

ORD. NO.	Bay width mm	Shelf depth mm	Usable width mm	Usable depth mm	Extension mm
F AR 7650 00 01	1250	900	1205	845	770
F AR 7660 00 01	1250	1100	1205	1045	970
F AR 7670 00 01	1250	1300	1205	1245	1170

Load capacity: 1000 kg

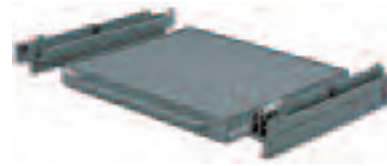

A FULL EXTENSION SHELVES WITH 4 SIDES AND MULTIPLEX WOODEN TOP

FOR BAY 850 mm WIDTH

ORD. NO.	Bay width mm	Shelf depth mm	Usable width mm	Usable depth mm	Extension mm
F AR 7450 01 01	850	900	805	845	770
F AR 7460 01 01	850	1100	805	1045	970
F AR 7470 01 01	850	1300	805	1245	1170

Load capacity: 1000 kg

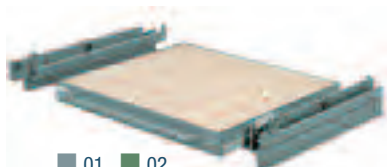

FOR BAY 1050 mm WIDTH

ORD. NO.	Bay width mm	Shelf depth mm	Usable width mm	Usable depth mm	Extension mm
F AR 7550 01 01	1050	900	1005	845	770
F AR 7560 01 01	1050	1100	1005	1045	970
F AR 7570 01 01	1050	1300	1005	1245	1170

Load capacity: 1000 kg

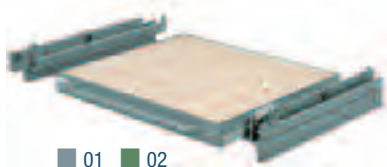

FOR BAY 1250 mm WIDTH

ORD. NO.	Bay width mm	Shelf depth mm	Usable width mm	Usable depth mm	Extension mm
F AR 7650 01 01	1250	900	1205	845	770
F AR 7660 01 01	1250	1100	1205	1045	970
F AR 7670 01 01	1250	1300	1205	1245	1170

Load capacity: 1000 kg

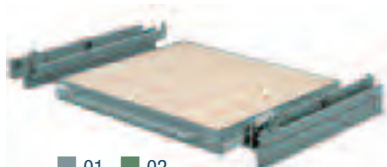

SHELVING SYSTEM SYSTEM AR

B NORMAL EXTENSION SHELVES WITH 3 EDGES

FOR BAY 1250 mm WIDTH

ORD. NO.	Bay width mm	Shelf depth mm	Usable width mm	Usable depth mm	Extension mm
F AR 6600 00 01	1250	900	1160	800	600
F AR 6610 00 01	1250	1100	1160	1000	750
F AR 6620 00 01	1250	1300	1160	1200	900

Load capacity: 800 kg

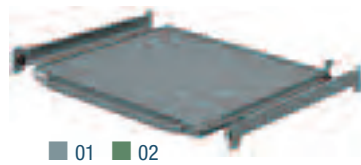

B NORMAL EXTENSION SHELVES WITH 4 EDGES

FOR BAY 1250 mm WIDTH

ORD. NO.	Bay width mm	Shelf depth mm	Usable width mm	Usable depth mm	Extension mm
F AR 6650 00 01	1250	900	1160	800	600
F AR 6660 00 01	1250	1100	1160	1000	750
F AR 6670 00 01	1250	1300	1160	1200	900

Load capacity: 800 kg

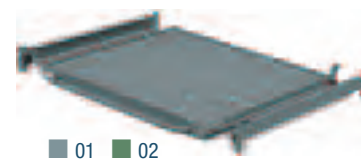

B NORMAL EXTENSION SHELVES WITH 4 SIDES AND MULTIPLEX WOODEN TOP

FOR BAY 1250 mm WIDTH

ORD. NO.	Bay width mm	Shelf depth mm	Usable width mm	Usable depth mm	Extension mm
F AR 6650 01 01	1250	900	1160	800	600
F AR 6660 01 01	1250	1100	1160	1000	750
F AR 6670 01 01	1250	1300	1160	1200	900

Load capacity: 800 kg

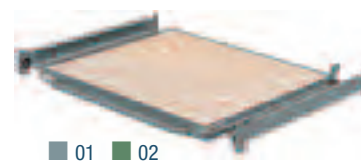

BACK PANELS

ORD. NO.	Shelving height mm	Back panel consisting of sections no.	Bay width mm
F AR 1450 00 01	1510	1	850
F AR 1460 00 01	2010	2	
F AR 1470 00 01	2210	2	
F AR 1480 00 01	2510	2	
F AR 1490 00 01	3010	2	
F AR 1500 00 01	1510	1	1050
F AR 1510 00 01	2010	2	
F AR 1520 00 01	2210	2	
F AR 1530 00 01	2510	2	
F AR 1540 00 01	3010	2	
F AR 1550 00 01	1510	1	1250
F AR 1560 00 01	2010	2	
F AR 1570 00 01	2210	2	
F AR 1580 00 01	2510	2	
F AR 1590 00 01	3010	2	

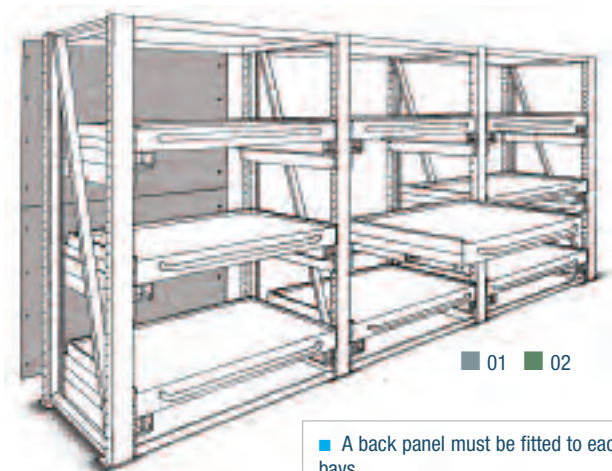

■ A back panel must be fitted to each 2 bays

RAL 7000 F... ..01 RAL 6011 F... ..02



KEY ■

■ All indicated loads are net and refer to evenly distributed weights



HEIGHT 1510 / 2010 / 2210 / 2510 / 3010 mm

SHELVING SYSTEM SYSTEM AR

SIDE PANELS

ORD. NO.	Shelving height mm	Side panel required q.ty of sections	Bay width mm
F AR 1250 00 04	1510	1	900
F AR 1260 00 04	2010	2	
F AR 1270 00 04	2210	2	
F AR 1280 00 04	2510	2	
F AR 1290 00 04	3010	2	
F AR 1300 00 04	1510	1	1100
F AR 1310 00 04	2010	2	
F AR 1320 00 04	2210	2	
F AR 1330 00 04	2510	2	
F AR 1340 00 04	3010	2	1300
F AR 1350 00 04	1510	1	
F AR 1360 00 04	2010	2	
F AR 1370 00 04	2210	2	
F AR 1380 00 04	2510	2	
F AR 1390 00 04	3010	2	

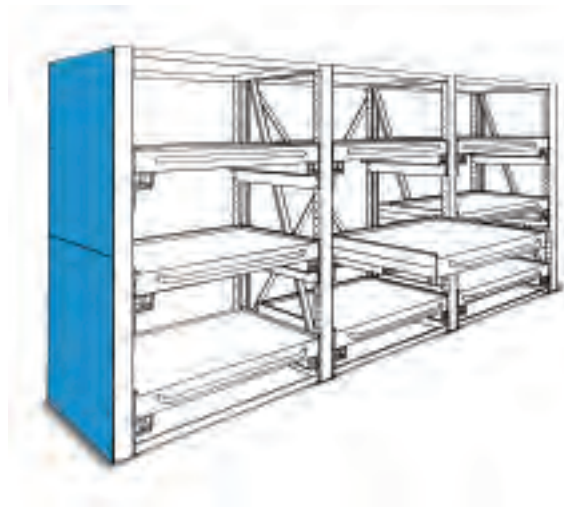

SLIDING DOORS

ORD. NO.	Shelving height mm	Shelf thickness mm	Bay width mm	Shelving width mm
F AR 5000 00 04	1510	165	850	1900
F AR 5050 00 04	2010	165		
F AR 5100 00 04	2210	165		
F AR 5150 00 04	2510	165		
F AR 5200 00 04	3010	165		
F AR 5250 00 04	1510	165	1050	2300
F AR 5300 00 04	2010	165		
F AR 5350 00 04	2210	165		
F AR 5400 00 04	2510	165		
F AR 5450 00 04	3010	165	1250	2700
F AR 5500 00 04	1510	165		
F AR 5550 00 04	2010	165		
F AR 5600 00 04	2210	165		
F AR 5650 00 04	2510	165		
F AR 5700 00 04	3010	165		

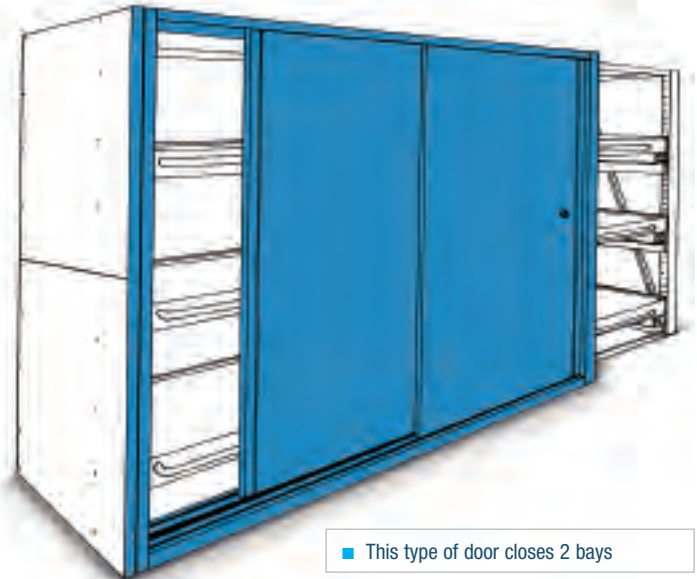

■ This type of door closes 2 bays

Supplied with cylinder lock and 2 keys.



■ SUPPLEMENTARY PARTS



■ **Spare key.** Always indicate the number on the cylinder lock of the key to be replaced.

ORD. NO. R CSC 0002 00

■ **Master key.** This type of key opens all the 45 and 46 series locks.

ORD. NO. R CSC 0001 00



RAL 6011 F.02 RAL 5012 F.04

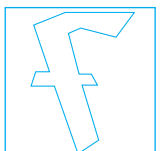

SHELVING SYSTEM SYSTEM SR



INSTRUCTIONS HANDBOOK

A complete and detailed instructions handbook is supplied standard with the shelving system.

This contains the following information:

- technical data
- intended use
- safety information and residue risk areas
- technical table for calculating the required floor strenght
- installation and assembly instructions
- fixing instructions.



LOAD TABLE

A load table is supplied **on request** with each shelving system.

The load table must be attached to a perfectly visible part of the shelving and shows:

- load capacity per bay
- load capacity of shelves and drawers
- max. distance between universal shelves
- max. distance between locking shelves

Example of load capacity table **supplied on request**

fami
www.famitpa.com

Scaffalatura serie
Shelving type
Regal Serie

ST

Anno di costruzione
Year of Manufacture
Herstellungsjahr

2002

Ordine n. / Order no. / Auftrag Nr.

12445

Max distance between universal shelves	1000 mm
Load capacity per bay	5500 kg
Load capacity of universal shelves	200 kg
Load capacity of locking shelves	200 kg
Load capacity of drawers	200 kg

Carico uniformemente distribuito / Uniformly distributed load / Gleichmäßig verteilte Last

RAL 7000 F.01

RAL 6011 F.02

RAL 5012 F.04

RAL 7035 F.08

SUPPLEMENTARY PARTS ■

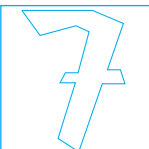

■ **Spare key.** Always indicate the number on the cylinder lock of the key to be replaced.

ORD. NO. R CSC 0002 00

■ **Master key.** This type of key opens all the 45 and 46 series locks.

ORD. NO. R CSC 0001 00





SHELVING SYSTEM SYSTEM SR 3627

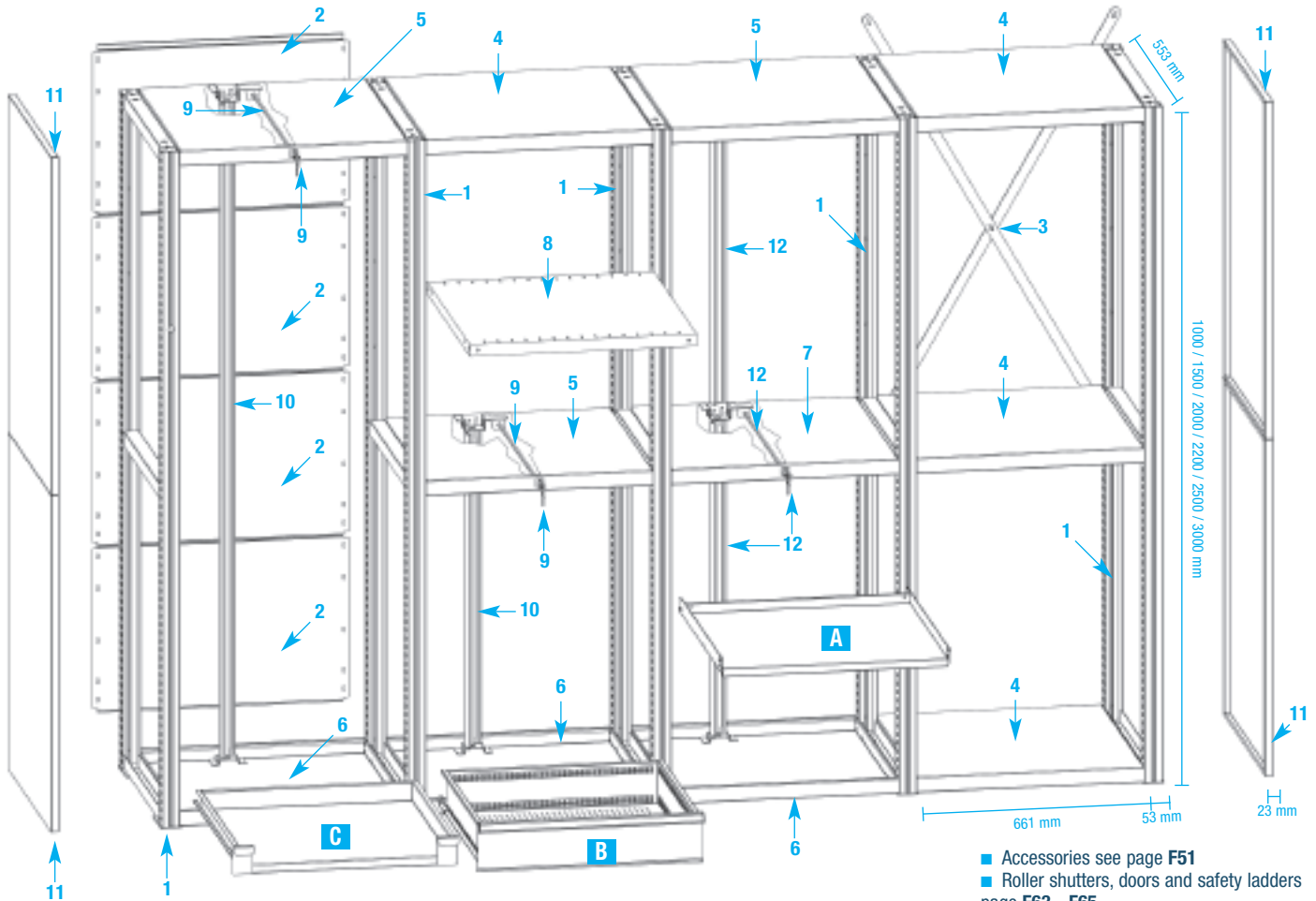

■ Accessories see page F51
 ■ Roller shutters, doors and safety ladders page F63 - F65

FIXING SET

Fixing material including (for 1 upright frame) no. 2 steel floor bolts M10x90 mm for uninterrupted concrete floors equal to or higher than class: B25 / RBK250 / MP_A 25N for mm².

ORD. NO. F SR 8999 00 99

■ Shelving must be fixed to the wall or floor.



LOAD CAPACITY PER BAY

Load capacity per bay kg	For distance between universal or locking shelves mm
4500	2000
5000	1500
5500	1000

REQUIRED QUANTITY OF UNIVERSAL OR LOCKING SHELVES PER BAY

Shelving height mm	Quantity of universal or locking shelves
1000	2
1500	2
2000	2
2200	3
2500	3
3000	3

1 UPRIGHT FRAMES ■ 01 ■ 02 ■ 04 ■ 08

ORD. NO.	DIM. mm
*F SR 0510 01 04	53x553x1000 h
*F SR 0516 01 04	53x553x1500 h
F SR 0520 00 04	53x553x2000 h
F SR 0522 00 04	53x553x2200 h
F SR 0525 00 04	53x553x2500 h
F SR 0530 00 04	53x553x3000 h

*Including cover panels

2 BACK PANELS ■ 01 ■ 02

ORD. NO.	DIM. mm
F SR 2020 00 01	1000 h
F SR 2031 00 01	1500 h
F SR 2040 00 01	2000 h
F SR 2050 00 01	2200 h
F SR 2060 00 01	2500 h
F SR 2070 00 01	3000 h

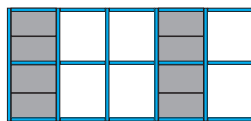

■ A back panel must be fitted to each third bay

3 CROSS BRACINGS ■ 01 ■ 02

ORD. NO.	For shelving height mm
F SR 7020 00 01	1500 / 2200
F SR 7050 00 01	2500 / 3000

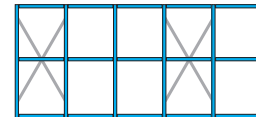

■ A cross bracing must be fitted to each third bay

4 UNIVERSAL SHELVES ■ 01 ■ 02 ■ 04 ■ 08

ORD. NO.	DIM. mm
F SR 1110 00 04	661x553x46 h

Load capacity: 250 kg

8 PERFORATED ADJUSTABLE SHELVES ■ 01 ■ 02 ■ 04 ■ 08

ORD. NO.	DIM. mm
F SR 1310 01 04	661x553x35 h

Load capacity: 300 kg

■ This type of shelf can be fitted only if anti-tilt rod is not fitted

5 TOP LOCKING SHELVES ■ 01 ■ 02 ■ 04 ■ 08

ORD. NO.	DIM. mm
F SR 1510 00 04	661x553x46 h

Load capacity: 200 kg

LENGTH = 714 mm DEPTH = 553 mm (36x27 Eh)

SHELVING SYSTEM SYSTEM SR 3627

6 BOTTOM LOCKING SHELVES ■ 01 ■ 02 ■ 04 ■ 08

ORD. NO.	DIM. mm
F SR 1610 00 04	661x553x46 h
Load capacity: 200 kg	

7 INTERMEDIATE LOCKING SHELVES ■ 01 ■ 02 ■ 04 ■ 08

ORD. NO.	DIM. mm
F SR 1710 00 04	661x553x46 h
Load capacity: 200 kg	

11 SIDE PANELS ■ 01 ■ 02 ■ 04 ■ 08

ORD. NO.	DIM. mm
F SR 2405 00 04	23x553x1000 h
F SR 2410 00 04	23x553x1100 h
F SR 2415 00 04	23x553x1250 h
F SR 2425 00 04	23x553x1500 h

9 LOCKING SET

ORD. NO.	For shelving depth mm
F SR 8101 00 00	553
Including 1 lock with 2 keys, 1 square rod, 1 anti-tilt rod activation group.	
■ Spare key see page F42	
Spare key (for lock ref. 9)	
ORD. NO. R CSR 0003 00	

10 ANTI-TILT ROD ■ 01

ORD. NO.	Rod height mm
F AG 9116 00 01	300
F AG 9124 00 01	500
F AG 9128 00 01	600
F AG 9132 00 01	700
F AG 9133 00 01	725
F AG 9134 00 01	750
F AG 9140 00 01	900
F AG 9146 00 01	1050
F AG 9150 00 01	1150
F AG 9153 00 01	1225
F AG 9160 00 01	1400
F AG 9165 00 01	1525
F AG 9170 00 01	1650
F AG 9180 00 01	1900

■ It is necessary to fit an anti-tilt rod if drawers or extension shelves are installed

12 LOCKING SYSTEM TOTAL HEIGHT ■ 01

ORD. NO.	Rod height mm	For frame height ref. 1 mm
F SR 8310 01 01	900+950 h	2000 h
F SR 8330 01 01	900+1150 h	2200 h
F SR 8350 01 01	900+1450 h	2500 h
F SR 8370 01 01	1400+1450 h	3000 h



C NORMAL EXTENSION SHELVES (PE-S) ■ 01 ■ 02 ■ 04 ■ 08

ORD. NO.	Usable dim. mm
F FG 8010 00 04	610x459
Side height: -	
Load capacity: 100 kg	
Extension: 87%	

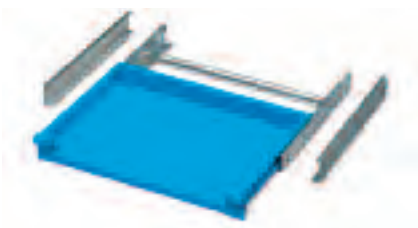

C TELESCOPIC FULL EXTENSION SHELVES (PE-TT) ■ 01 ■ 02 ■ 04 ■ 08

ORD. NO.	Usable dim. mm
F FG 8110 00 04	610x459
Side height: -	
Load capacity: 200 kg	
Extension: 100%	



A ADJUSTABLE SHELVES ■ 01 ■ 02 ■ 04 ■ 08

ORD. NO.	DIM. mm
F SR 1210 01 04	655x460x25 h
Load capacity: 150 kg	
■ This type of shelf can be fitted even if anti-tilt rod is fitted	

B NORMAL EXTENSION DRAWERS (S) ■ 01 ■ 02 ■ 04 ■ 08

ORD. NO.	Usable dim. mm	Front height	Load capacity kg	Extension
F FG 1005 00 04	600x447x36 h	50	60	87%
F FG 1007 00 04	600x447x61 h	75	80	87%
F FG 1010 00 04	600x447x86 h	100	100	87%
F FG 1012 00 04	600x447x111 h	125	100	87%



■ Set of partitions see page A80 - A81

B TELESCOPIC FULL EXTENSION DRAWERS (TT) ■ 01 ■ 02 ■ 04 ■ 08

ORD. NO.	Usable dim. mm	Front height	Load capacity kg	Extension
F FG 1107 00 04	600x447x54 h	75	200	100%
F FG 1110 00 04	600x447x79 h	100	200	100%
F FG 1112 00 04	600x447x104 h	125	200	100%
F FG 1115 00 04	600x447x129 h	150	200	100%
F FG 1120 00 04	600x447x179 h	200	200	100%
F FG 1125 00 04	600x447x229 h	250	200	100%
F FG 1130 00 04	600x447x279 h	300	200	100%

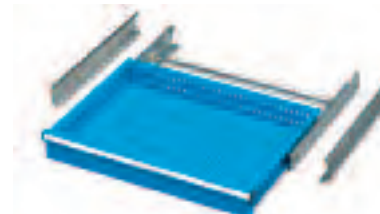

■ Set of partitions see page A80 - A81

SHELVING SYSTEM SYSTEM SR 3627

TOOL HOLDERS FRAME

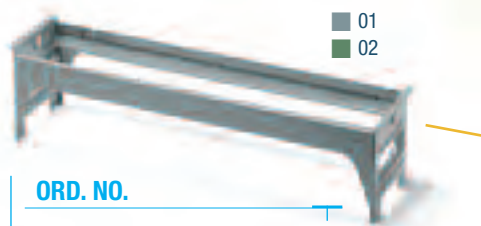

ORD. NO.

F NC 5020 00 01

Horizontal frame load cap.: 50 kg

Dimensions mm 584x140x146 h

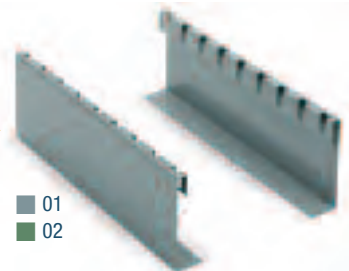
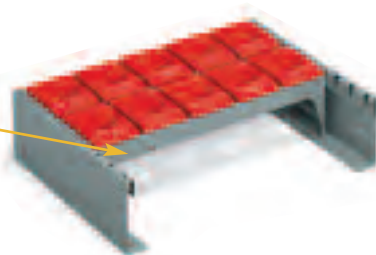

01
02

PAIR OF CARRIERS FOR FRAME

ORD. NO.

F NC 5730 00 01

For frame ORD. NO. F NC 5020 00 01

Overall dim. mm 442x150 h

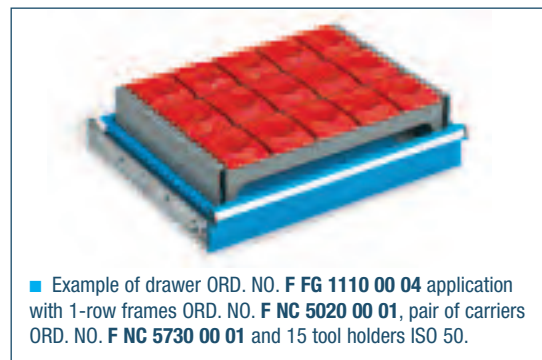

■ Example of drawer ORD. NO. F FG 1110 00 04 application with 1-row frames ORD. NO. F NC 5020 00 01, pair of carriers ORD. NO. F NC 5730 00 01 and 15 tool holders ISO 50.



99

PAIR OF GALVANISED HANDLE

ORD. NO.

F NC 5005 00 99

For frame ORD. NO. F NC 5020 00 01

TOOL FOR MULTIPLEX WOODEN INSERT



ORD. NO.

F NC 5021 00 01

Horizontal frame load capacity: 50 kg

Overall dimensions mm 584x140x146 h



ORD. NO.

F NC 2510 00 00

Multiplex wooden insert

Overall dimensions mm 525x138x50 h



Example of tool holder frame ORD. NO. F NC 5021 00 ..

ALUMINIUM INSERT

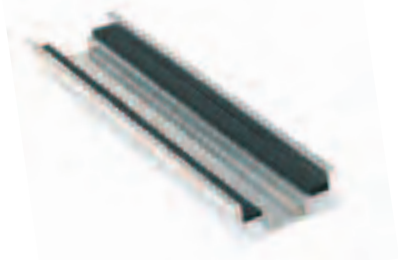

ORD. NO.

F NC 2410 00 00

Aluminium insert with rubber

OVERALL DIMENSIONS mm

525x135x45 h

WOODEN INSERT



01
02

ORD. NO.

F NC 2530 00 01

Wooden insert

OVERALL DIMENSIONS mm

600x450x160 h



Example of tool holder frame ORD. NO. F NC 5020 00 ..



Example of drawer ORD. NO. F FG 1110 00 04 application with wooden insert ORD. NO. F NC 2530 00 00.

LENGTH = 714 mm DEPTH = 553 mm (36x27 Eh)

SHELVING SYSTEM SYSTEM SR 3627

TOOL HOLDER FRAMES 3-ROWS FOR DRAWERS

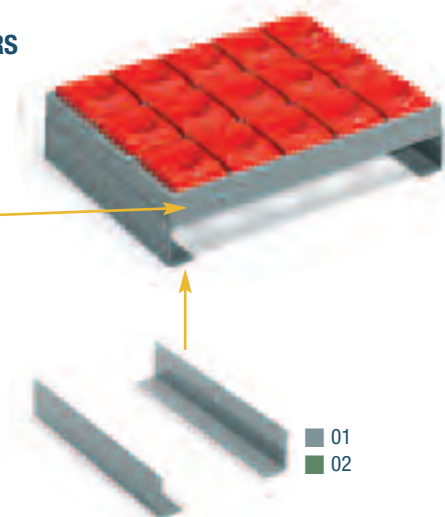

■ The tool holder frame load capacity is given by the drawer load capacity

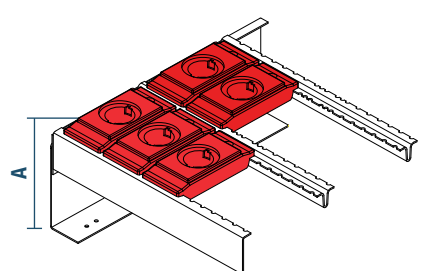
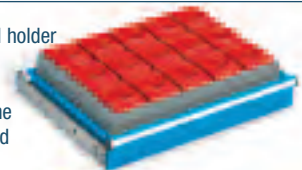

ORD. NO.

F NC 5120 00 01

Overall dimension mm 584x444x69 h

PAIR OF CARRIERS

ORD. NO.

DIMENSIONS mm

FOR HEIGHT TAPER mm REF. A

F NC 5630 00 01

446x86 h

A = 93 / 118 / 143

F NC 5830 00 01

446x136 h

A = 143 / 168 / 193

ORD. NO. TOOL HOLDERS

TOOL HOLDER TYPE MAX QUANTITY PER TOOL FRAME F NC 5020 00 .. MAX QUANTITY PER TOOL FRAME F NC 5120 00 ..

F NC 9510 00 03	ISO 30	7	24
F NC 9530 00 03	ISO 40	7	24
F NC 9540 00 03	ISO 45	5	18
F NC 9550 00 03	ISO 50	5	15
F NC 9560 00 03	VDI 30	7	24
F NC 9570 00 03	VDI 40	5	18
F NC 9580 00 03	VDI 50	5	18
F NC 9590 00 03	VDI 60	5	15
F NC 9720 00 03	MORSE TAPER 2	7	24
F NC 9730 00 03	MORSE TAPER 3	7	24
F NC 9740 00 03	MORSE TAPER 4	7	24
F NC 9750 00 03	MORSE TAPER 5	5	18
F NC 9270 00 03	CAPTO C3	7	24
F NC 9275 00 03	CAPTO C4	5	18
F NC 9280 00 03	CAPTO C5	5	18

ORD. NO. TOOL HOLDERS

TOOL HOLDER TYPE MAX QUANTITY PER TOOL FRAME F NC 5020 00 .. MAX QUANTITY PER TOOL FRAME F NC 5120 00 ..

F NC 9285 00 03	CAPTO C6	5	18
F NC 9290 00 03	CAPTO C8	4	12
F NC 9210 00 03	HSK A32-B40	7	24
F NC 9220 00 03	HSK A40-B50	7	24
F NC 9230 00 03	HSK A50-B63	5	18
F NC 9240 00 03	HSK A63-B80	5	18
F NC 9250 00 03	HSK A80-B100	4	12
F NC 9260 00 03	HSK A100-B125	4	12
F NC 9640 00 03	2"	5	18
F NC 9650 00 03	2" 1/4	5	15
F NC 9010 00 03	58 mm	9	27
F NC 9020 00 03	65 mm	8	24
F NC 9030 00 03	75 mm	7	21
F NC 9040 00 03	87 mm	6	18
F NC 9050 00 03	105 mm	5	15

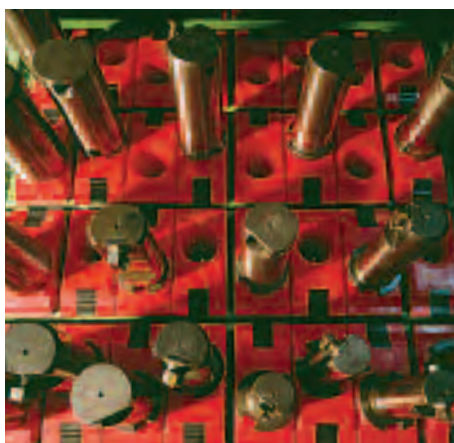

SHELVING SYSTEM SYSTEM SR 5427

LENGTH = 1020 mm DEPTH = 553 mm (54x27 Eh)

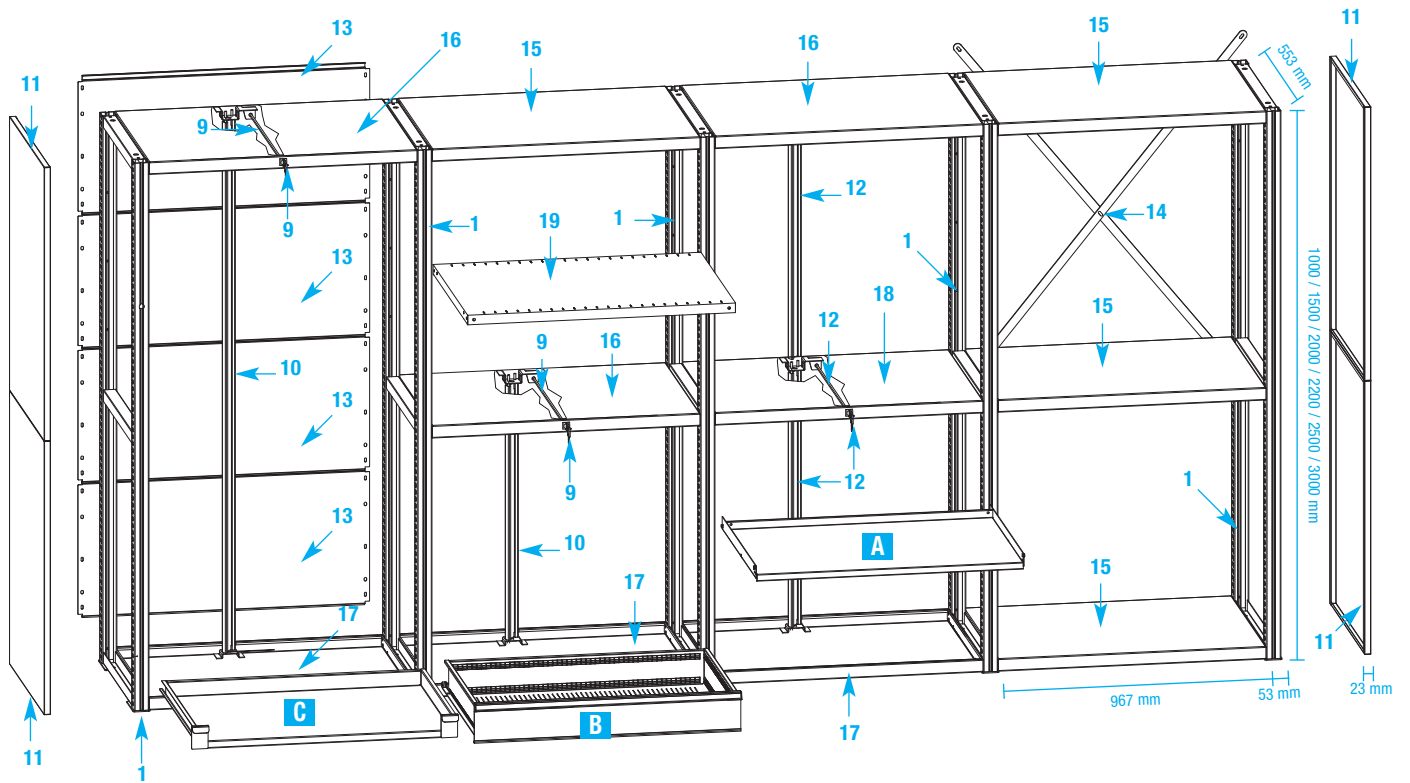

■ Accessories see page F51
 ■ Roller shutters, doors and safety ladders page F63 - F65

FIXING SET

Fixing material including (for 1 upright frame) no. 2 steel floor bolts M10x90 mm for uninterrupted concrete floors equal to or higher than class: B25 / RBK250 / MP_A 25N for mm².

ORD. NO. F SR 8999 00 99

■ Shelving must be fixed to the wall or floor.



LOAD CAPACITY PER BAY

Load capacity per bay kg	For distance between universal or locking shelves mm
4500	2000
5000	1500
5500	1000

REQUIRED QUANTITY OF UNIVERSAL OR LOCKING SHELVES PER BAY

Shelving height mm	Quantity of universal or locking shelves
1000	2
1500	2
2000	2
2200	3
2500	3
3000	3

1 UPRIGHT FRAMES ■ 01 ■ 02 ■ 04 ■ 08

ORD. NO.	DIM. mm
*F SR 0510 01 04	53x553x1000 h
*F SR 0516 01 04	53x553x1500 h
F SR 0520 00 04	53x553x2000 h
F SR 0522 00 04	53x553x2200 h
F SR 0525 00 04	53x553x2500 h
F SR 0530 00 04	53x553x3000 h

*Including cover panels

13 BACK PANELS ■ 01 ■ 02

ORD. NO.	DIM. mm
F SR 2120 00 01	1000 h
F SR 2131 00 01	1500 h
F SR 2140 00 01	2000 h
F SR 2150 00 01	2200 h
F SR 2160 00 01	2500 h
F SR 2170 00 01	3000 h

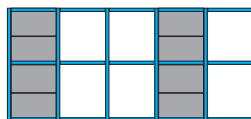

■ A back panel must be fitted to each third bay

14 CROSS BRACINGS ■ 01 ■ 02

ORD. NO.	For shelving height mm
F SR 7120 00 01	1500 / 2200
F SR 7150 00 01	2500 / 3000

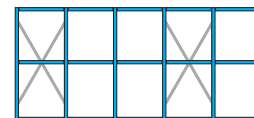

■ A cross bracing must be fitted to each third bay

15 UNIVERSAL SHELVES ■ 01 ■ 02 ■ 04 ■ 08

ORD. NO.	DIM. mm
F SR 1120 00 04	967x553x46 h

Load capacity: 250 kg

19 PERFORATED ADJUSTABLE SHELVES ■ 01 ■ 02 ■ 04 ■ 08

ORD. NO.	DIM. mm
F SR 1320 01 04	967x553x35 h

Load capacity: 300 kg

■ This type of shelf can be fitted only if anti-tilt rod is not fitted

16 TOP LOCKING SHELVES ■ 01 ■ 02 ■ 04 ■ 08

ORD. NO.	DIM. mm
F SR 1520 00 04	967x553x46 h

Load capacity: 200 kg

LENGTH = 1020 mm DEPTH = 553 mm (54x27 Eh)

SHELVING SYSTEM SYSTEM SR 5427

17 BOTTOM LOCKING SHELVES ■ 01 ■ 02 ■ 04 ■ 08

ORD. NO.	DIM. mm
F SR 1620 00 04	967x553x46 h
Load capacity: 200 kg	

18 INTERMEDIATE LOCKING SHELVES ■ 01 ■ 02 ■ 04 ■ 08

ORD. NO.	DIM. mm
F SR 1720 00 04	967x553x46 h
Load capacity: 200 kg	

11 SIDE PANELS ■ 01 ■ 02 ■ 04 ■ 08

ORD. NO.	DIM. mm
F SR 2405 00 04	23x553x1000 h
F SR 2410 00 04	23x553x1100 h
F SR 2415 00 04	23x553x1250 h
F SR 2425 00 04	23x553x1500 h

9 LOCKING SET

ORD. NO.	For shelving depth mm
F SR 8101 00 00	553
Including 1 lock with 2 keys, 1 square rod, 1 anti-tilt rod activation group.	
■ Spare key see page F42	
Spare key (for lock ref. 9)	
ORD. NO. R CSR 0003 00	

10 ANTI-TILT ROD ■ 01

ORD. NO.	Rod height mm
F AG 9116 00 01	300
F AG 9124 00 01	500
F AG 9128 00 01	600
F AG 9132 00 01	700
F AG 9133 00 01	725
F AG 9134 00 01	750
F AG 9140 00 01	900
F AG 9146 00 01	1050
F AG 9150 00 01	1150
F AG 9153 00 01	1225
F AG 9160 00 01	1400
F AG 9165 00 01	1525
F AG 9170 00 01	1650
F AG 9180 00 01	1900

■ It is necessary to fit an anti-tilt rod if drawers or extension shelves are installed

12 LOCKING SYSTEM TOTAL HEIGHT ■ 01

ORD. NO.	Rod height mm	For frame height ref. 1 mm
F SR 8310 01 01	900+950 h	2000 h
F SR 8330 01 01	900+1150 h	2200 h
F SR 8350 01 01	900+1450 h	2500 h
F SR 8370 01 01	1400+1450 h	3000 h



C NORMAL EXTENSION SHELVES (PE-S) ■ 01 ■ 02 ■ 04 ■ 08

ORD. NO.	Usable dim. mm
F FG 8040 00 04	916x457
Side height: -	
Load capacity: 100 kg	
Extension: 87%	

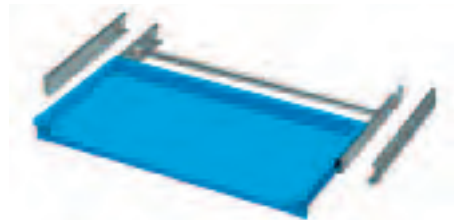

C TELESCOPIC FULL EXTENSION SHELVES (PE-TT) ■ 01 ■ 02 ■ 04 ■ 08

ORD. NO.	Usable dim. mm
F FG 8140 00 04	916x457
Side height: -	
Load capacity: 150 kg	
Extension: 100%	



A ADJUSTABLE SHELVES ■ 01 ■ 02 ■ 04 ■ 08

ORD. NO.	DIM. mm
F SR 1220 01 04	967x465x25 h
Load capacity: 100 kg	
■ This type of shelf can be fitted even if anti-tilt rod is fitted	

B NORMAL EXTENSION DRAWERS (S) ■ 01 ■ 02 ■ 04 ■ 08

ORD. NO.	Usable dim. mm	Front height	Load capacity kg	Extension
F FG 4005 00 04	906x447x36 h	50	60	87%
F FG 4007 00 04	906x447x61 h	75	80	87%
F FG 4010 00 04	906x447x86 h	100	100	87%
F FG 4012 00 04	906x447x111 h	125	100	87%



B TELESCOPIC FULL EXTENSION DRAWERS (TT) ■ 01 ■ 02 ■ 04 ■ 08

ORD. NO.	Usable dim. mm	Front height	Load capacity kg	Extension
F FG 4107 00 04	906x447x54 h	75	150	100%
F FG 4110 00 04	906x447x79 h	100	150	100%
F FG 4112 00 04	906x447x104 h	125	150	100%
F FG 4115 00 04	906x447x129 h	150	150	100%
F FG 4120 00 04	906x447x179 h	200	150	100%
F FG 4125 00 04	906x447x229 h	250	150	100%
F FG 4130 00 04	906x447x279 h	300	150	100%

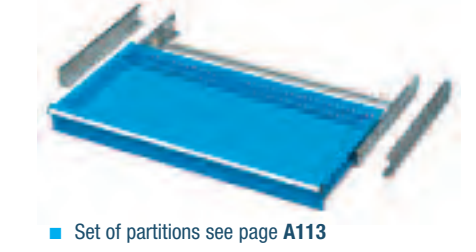

SHELVING SYSTEM SYSTEM SR 5427

TOOL HOLDER FRAMES 3-ROWS FOR DRAWERS

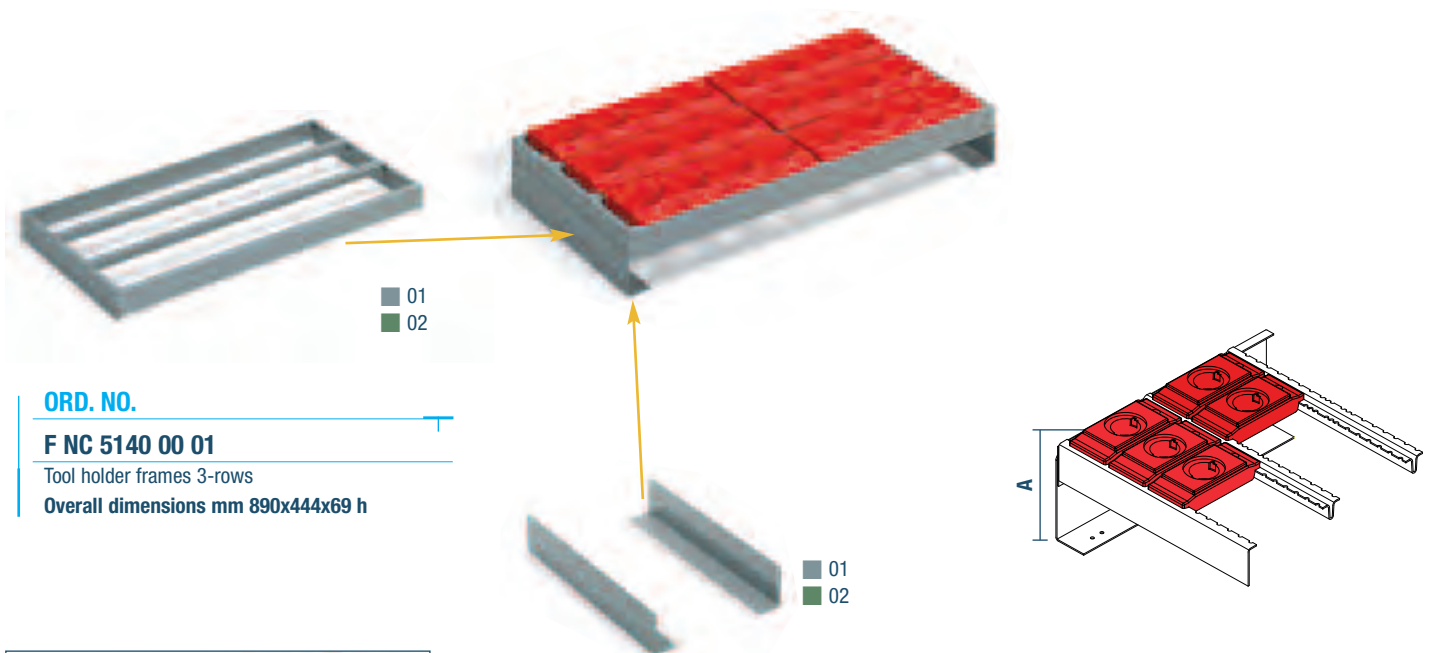

ORD. NO.

F NC 5140 00 01

Tool holder frames 3-rows

Overall dimensions mm 890x444x69 h

■ The tool holder frame load capacity is given by the drawer load capacity

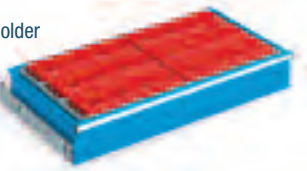

PAIR OF CARRIERS

ORD. NO.

DIMENSIONS mm

FOR HEIGHT TAPER mm REF. A

F NC 5630 00 01

446x86 h

A = 93 / 118 / 143

F NC 5830 00 01

446x136 h

A = 143 / 168 / 193

ORD. NO. TOOL HOLDERS

TOOL HOLDER TYPE

MAX QUANTITY PER TOOL FRAME F NC 5140 00 ..

F NC 9510 00 03	ISO 30	33
F NC 9530 00 03	ISO 40	33
F NC 9540 00 03	ISO 45	27
F NC 9550 00 03	ISO 50	24
F NC 9560 00 03	VDI 30	33
F NC 9570 00 03	VDI 40	27
F NC 9580 00 03	VDI 50	27
F NC 9590 00 03	VDI 60	24
F NC 9720 00 03	MORSE TAPER 2	33
F NC 9730 00 03	MORSE TAPER 3	33
F NC 9740 00 03	MORSE TAPER 4	33
F NC 9750 00 03	MORSE TAPER 5	27
F NC 9270 00 03	CAPTO C3	33
F NC 9275 00 03	CAPTO C4	27
F NC 9280 00 03	CAPTO C5	27

ORD. NO. TOOL HOLDERS

TOOL HOLDER TYPE

MAX QUANTITY PER TOOL FRAME F NC 5140 00 ..

F NC 9285 00 03	CAPTO C6	27
F NC 9290 00 03	CAPTO C8	21
F NC 9210 00 03	HSK A32-B40	33
F NC 9220 00 03	HSK A40-B50	33
F NC 9230 00 03	HSK A50-B63	27
F NC 9240 00 03	HSK A63-B80	27
F NC 9250 00 03	HSK A80-B100	21
F NC 9260 00 03	HSK A100-B125	21
F NC 9640 00 03	2"	27
F NC 9650 00 03	2" 1/4	24
F NC 9010 00 03	58 mm	42
F NC 9020 00 03	65 mm	39
F NC 9030 00 03	75 mm	33
F NC 9040 00 03	87 mm	27
F NC 9050 00 03	105 mm	24

DEPTH = 553 mm (54x27 Eh)

SHELVING SYSTEM SYSTEM SR 0553

COVER PANELS

■ 01 ■ 02
■ 04 ■ 08

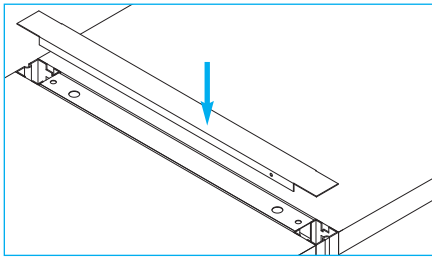

ORD. NO.

F SR 2510 00 04

For shelving depth 553 mm

INFIL PANELS

■ 01 ■ 02
■ 04 ■ 08

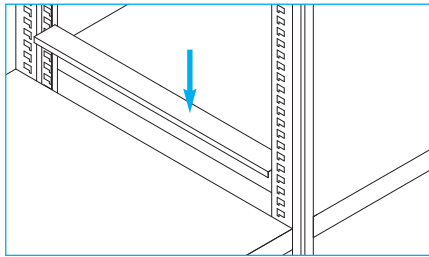

ORD. NO.

F SR 2710 00 04

For shelving depth 553 mm

SHELF SIDE PANELS

■ 01 ■ 02

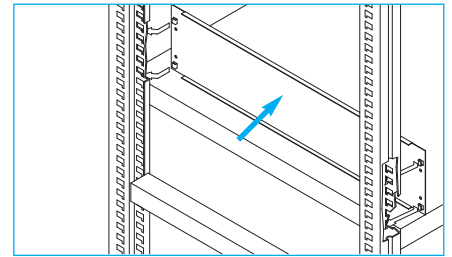

ORD. NO.

HEIGHT mm h

F SR 2610 00 01

150

F SR 2620 00 01

200

F SR 2630 00 01

250

For shelving depth 553 mm

PARTITIONS

■ 01 ■ 02

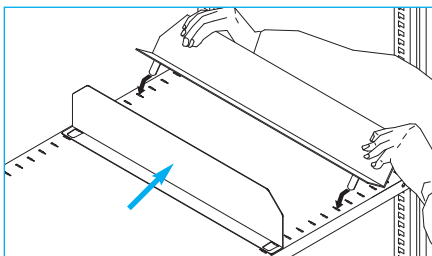

ORD. NO.

HEIGHT mm h

F SR 2820 00 01

95

F SR 2830 00 01

145

F SR 2840 00 01

195

For shelving depth 553 mm

HOOK



■ 99

ORD. NO.

F SL 1910 00 99

Galvanised hook for adjustable shelf

DRAWING POCKETS



ORD. NO.

DIMENSIONS mm

C MV 15 005

332x210 h DIN A4

C MV 15 006

218x148 h DIN A5

MAGNETIC SUPPORT WITH LABEL



ORD. NO.

F ST 9997 00 00

Magnetic support with label and cellophane
Length 1000 mm

ORD. NO.

R FST 0007 00

Spare label and cellophane (100 pcs)

MULTIPLEX WORKTOP

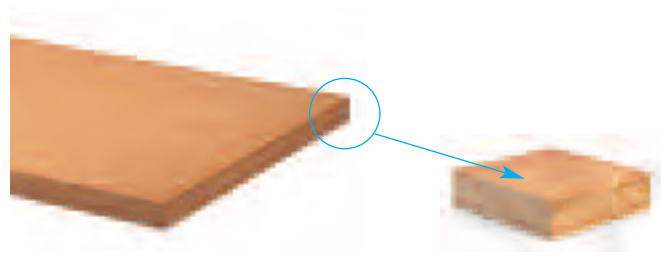

ORD. NO.

DIMENSIONS mm

F SR 0020 00 00

967x553x40 h



Using the Multiplex worktop

SHELVING SYSTEM SYSTEM SR 3636

WIDTH = 714 mm DEPTH = 705 mm (36x36 Eh)

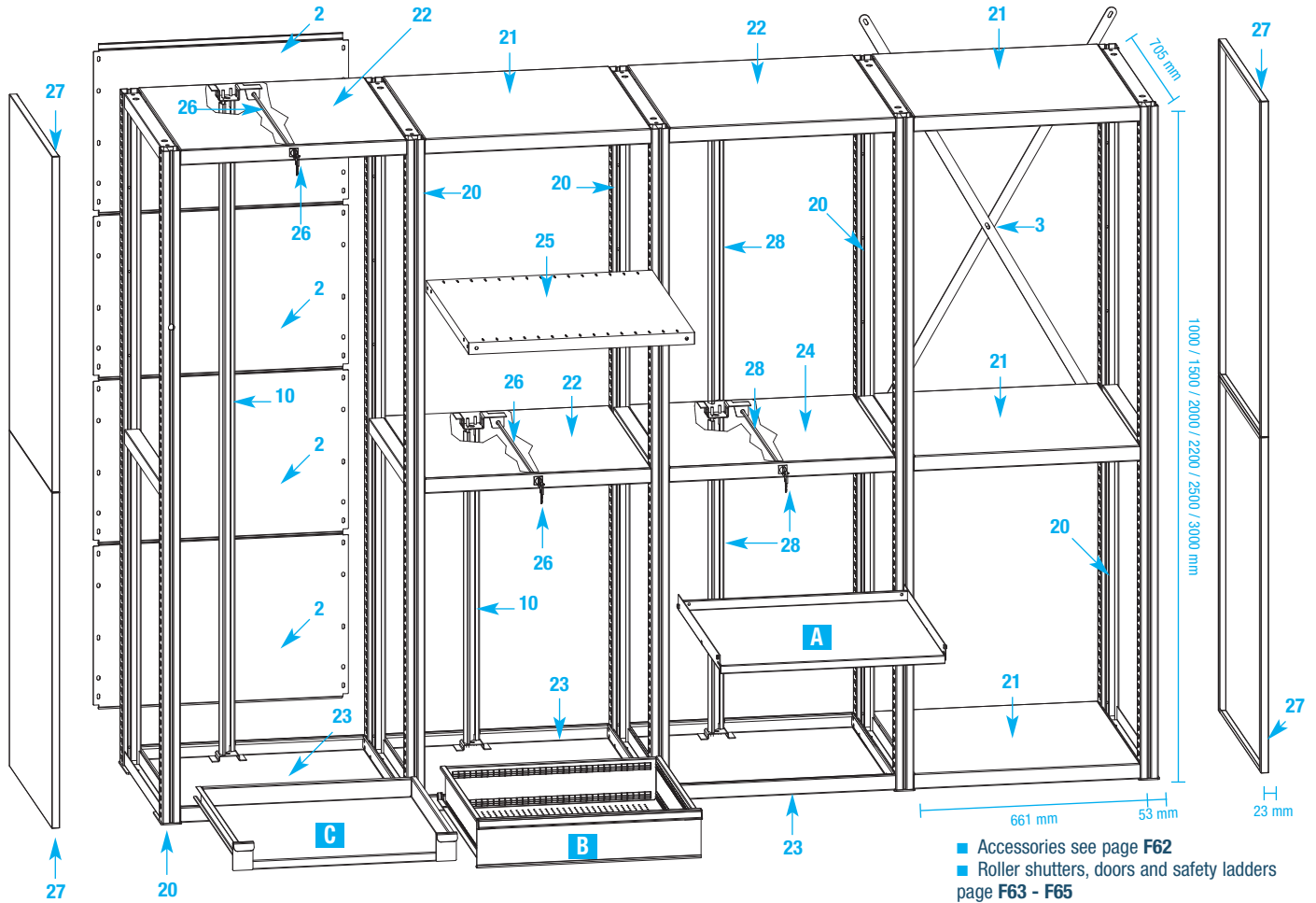

■ Accessories see page F62
 ■ Roller shutters, doors and safety ladders page F63 - F65

FIXING SET

Fixing material including (for 1 upright frame) no. 2 steel floor bolts M10x90 mm for uninterrupted concrete floors equal to or higher than class: B25 / RBK250 / MP_A 25N for mm².

ORD. NO. F SR 8999 00 99

■ Shelving must be fixed to the wall or floor.



LOAD CAPACITY PER BAY

Load capacity per bay kg	For distance between universal or locking shelves mm
4500	2000
5000	1500
5500	1000

REQUIRED QUANTITY OF UNIVERSAL OR LOCKING SHELVES PER BAY

Shelving height mm	Quantity of universal or locking shelves
1000	2
1500	2
2000	2
2200	3
2500	3
3000	3

20 UPRIGHT FRAMES ■ 01 ■ 02 ■ 04 ■ 08

ORD. NO.	DIM. mm
*F SR 0710 01 04	53x705x1000 h
*F SR 0716 01 04	53x705x1500 h
F SR 0720 00 04	53x705x2000 h
F SR 0722 00 04	53x705x2200 h
F SR 0725 00 04	53x705x2500 h
F SR 0730 00 04	53x705x3000 h

*Including cover panels

2 BACK PANELS ■ 01 ■ 02

ORD. NO.	DIM. mm
F SR 2020 00 01	1000 h
F SR 2031 00 01	1500 h
F SR 2040 00 01	2000 h
F SR 2050 00 01	2200 h
F SR 2060 00 01	2500 h
F SR 2070 00 01	3000 h

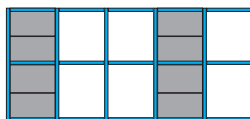

■ A back panel must be fitted to each third bay

3 CROSS BRACINGS ■ 01 ■ 02

ORD. NO.	For shelving height mm
F SR 7020 00 01	1500 / 2200
F SR 7050 00 01	2500 / 3000

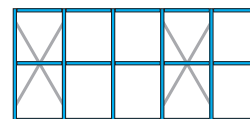

■ A cross bracing must be fitted to each third bay

21 UNIVERSAL SHELVES ■ 01 ■ 02 ■ 04 ■ 08

ORD. NO.	DIM. mm
F SR 1160 00 04	661x705x46 h

Load capacity: 250 kg

25 PERFORATED ADJUSTABLE SHELVES ■ 01 ■ 02 ■ 04 ■ 08

ORD. NO.	DIM. mm
F SR 1360 01 04	661x705x35 h

Load capacity: 300 kg

■ This type of shelf can be fitted only if anti-tilt rod is not fitted

22 TOP LOCKING SHELVES ■ 01 ■ 02 ■ 04 ■ 08

ORD. NO.	DIM. mm
F SR 1560 00 04	661x705x46 h

Load capacity: 200 kg

WIDTH = 714 mm DEPTH = 705 mm (36x36 Eh)

SHELVING SYSTEM SYSTEM SR 3636

23 BOTTOM LOCKING SHELVES ■ 01 ■ 02 ■ 04 ■ 08

ORD. NO.	DIM. mm
F SR 1660 00 04	661x705x46 h
Load capacity: 200 kg	

24 INTERMEDIATE LOCKING SHELVES ■ 01 ■ 02 ■ 04 ■ 08

ORD. NO.	DIM. mm
F SR 1760 00 04	661x705x46 h
Load capacity: 200 kg	

27 SIDE PANELS ■ 01 ■ 02 ■ 04 ■ 08

ORD. NO.	DIM. mm
F SR 2455 00 04	23x705x1000 h
F SR 2460 00 04	23x705x1100 h
F SR 2465 00 04	23x705x1250 h
F SR 2475 00 04	23x705x1500 h

26 LOCKING SET

ORD. NO.	For shelving depth mm
F SR 8102 00 00	705
Including 1 lock with 2 keys, 1 square rod, 1 anti-tilt rod activation group.	
■ Spare key see page F42	
Spare key (for lock ref. 26)	
ORD. NO. R CSR 0003 00	

28 LOCKING SYSTEM TOTAL HEIGHT ■ 01

ORD. NO.	Rod height mm	For frame height ref. 1 mm
F SR 8310 51 01	900+950 h	2000 h
F SR 8330 51 01	900+1150 h	2200 h
F SR 8350 51 01	900+1450 h	2500 h
F SR 8370 51 01	1400+1450 h	3000 h

10 ANTI-TILT ROD ■ 01

ORD. NO.	Rod height mm
F AG 9116 00 01	300
F AG 9124 00 01	500
F AG 9128 00 01	600
F AG 9132 00 01	700
F AG 9133 00 01	725
F AG 9134 00 01	750
F AG 9140 00 01	900
F AG 9146 00 01	1050
F AG 9150 00 01	1150
F AG 9153 00 01	1225
F AG 9160 00 01	1400
F AG 9165 00 01	1525
F AG 9170 00 01	1650
F AG 9180 00 01	1900

■ It is necessary to fit an anti-tilt rod if drawers or extension shelves are installed

C NORMAL EXTENSION SHELVES (PE-S) ■ 01 ■ 02 ■ 04 ■ 08

ORD. NO.	Usable dim. mm
F FG 8020 00 04	610x610
Side height: -	
Load capacity: 100 kg	
Extension: 87%	

C TELESCOPIC FULL EXTENSION SHELVES (PE-TT) ■ 01 ■ 02 ■ 04 ■ 08

ORD. NO.	Usable dim. mm
F FG 8120 00 04	610x610
Side height: -	
Load capacity: 200 kg	
Extension: 100%	

A ADJUSTABLE SHELVES ■ 01 ■ 02 ■ 04 ■ 08

ORD. NO.	DIM. mm
F SR 1260 01 04	618x618x25 h
Load capacity: 150 kg	

■ This type of shelf can be fitted even if anti-tilt rod is fitted

B NORMAL EXTENSION DRAWERS (S) ■ 01 ■ 02 ■ 04 ■ 08

ORD. NO.	Usable dim. mm	Front height	Load capacity kg	Extension
F FG 2005 00 04	600x600x36 h	50	60	87%
F FG 2007 00 04	600x600x61 h	75	80	87%
F FG 2010 00 04	600x600x86 h	100	100	87%
F FG 2012 00 04	600x600x111 h	125	100	87%
F FG 2015 00 04	600x600x136 h	150	100	87%
F FG 2017 00 04	600x600x161 h	175	100	87%
F FG 2020 00 04	600x600x186 h	200	100	87%
F FG 2030 00 04	600x600x286 h	300	100	87%

B TELESCOPIC FULL EXTENSION DRAWERS (TT) ■ 01 ■ 02 ■ 04 ■ 08

ORD. NO.	Usable dim. mm	Front height	Load capacity kg	Extension
F FG 2107 00 04	600x600x54 h	75	200	100%
F FG 2110 00 04	600x600x79 h	100	200	100%
F FG 2112 00 04	600x600x104 h	125	200	100%
F FG 2115 00 04	600x600x129 h	150	200	100%
F FG 2117 00 04	600x600x154 h	175	200	100%
F FG 2120 00 04	600x600x179 h	200	200	100%
F FG 2125 00 04	600x600x229 h	250	200	100%
F FG 2130 00 04	600x600x279 h	300	200	100%
F FG 2140 00 04	600x600x379 h	400	200	100%

■ Set of partitions see page A96 - A97

■ Set of partitions see page A96 - A97

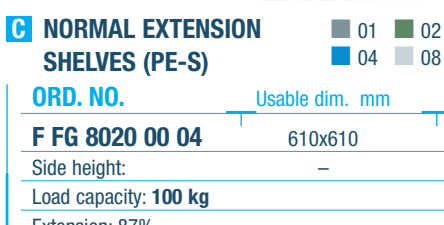
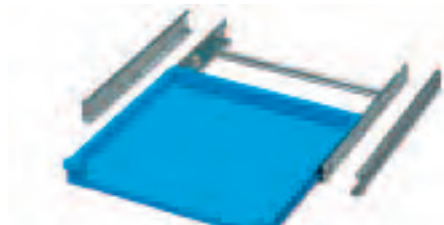

SHELVING SYSTEM SYSTEM SR 3636

TOOL HOLDERS FRAME



ORD. NO.

F NC 5020 00 01

Horizontal frame load cap.: 50 kg

Dimensions mm 584x140x146 h

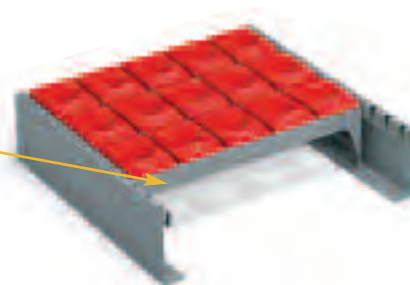

01
02

PAIR OF CARRIERS

ORD. NO.

F NC 5750 00 01

For frame ORD. NO. F NC 5020 00 01

Overall dimensions mm 592x150 h

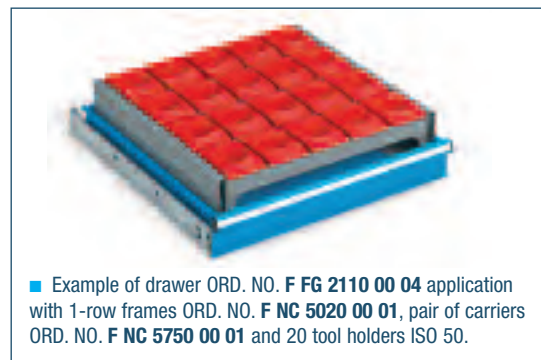

■ Example of drawer ORD. NO. F FG 2110 00 04 application with 1-row frames ORD. NO. F NC 5020 00 01, pair of carriers ORD. NO. F NC 5750 00 01 and 20 tool holders ISO 50.



PAIR OF GALVANISED HANDLE

ORD. NO.

F NC 5005 00 99

For frame ORD. NO. F NC 5020 00 01

TOOL FOR MULTIPLEX WOODEN INSERT



01
02

ORD. NO.

F NC 5021 00 01

Horizontal frame load capacity: 50 kg

Overall dimensions mm 584x140x146 h



ORD. NO.

F NC 2510 00 00

Multiplex wooden insert

Overall dimensions mm 525x138x50 h



Example of tool holder frame ORD. NO. F NC 5021 00 ..

ALUMINIUM INSERT

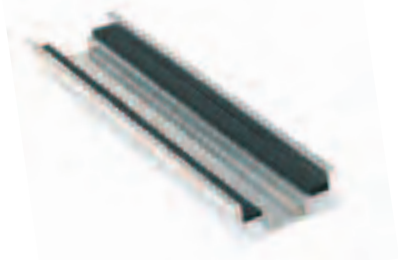

ORD. NO.

F NC 2410 00 00

Aluminium insert with rubber

OVERALL DIMENSIONS mm

525x135x45 h

WOODEN INSERT



01
02

ORD. NO.

F NC 2550 00 01

Wooden insert

OVERALL DIMENSIONS mm

600x600x160 h



Example of tool holder frame ORD. NO. F NC 5020 00 ..



Example of drawer ORD. NO. F FG 2110 00 04 application with wooden insert ORD. NO. F NC 2550 00 00.

WIDTH = 714 mm DEPTH = 705 mm (36x36 Eh)

SHELVING SYSTEM SYSTEM SR 3636

TOOL HOLDER FRAMES 4-ROWS FOR DRAWERS

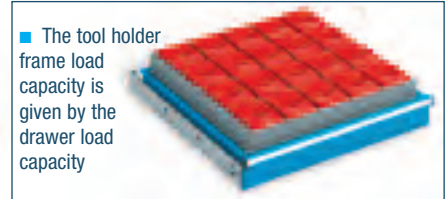
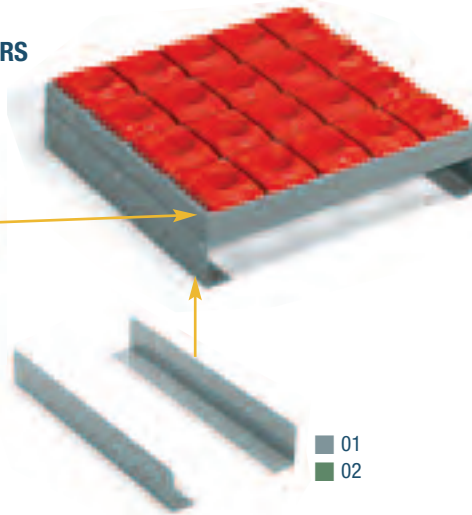

The tool holder frame load capacity is given by the drawer load capacity

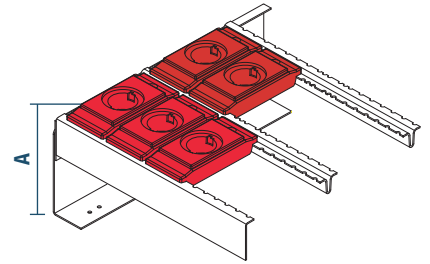

ORD. NO.

F NC 5220 00 01

Overall dimensions mm 584x592x69 h

PAIR OF CARRIERS

ORD. NO.

DIMENSIONS mm

FOR HEIGHT TAPER mm REF. A

F NC 5650 00 01

594X86 h

A = 93 / 118 / 143

F NC 5840 00 01

594X136 h

A = 143 / 168 / 193

ORD. NO. TOOL HOLDERS



TOOL HOLDER TYPE	MAX QUANTITY PER TOOL FRAME F NC 5020 00 ..	MAX QUANTITY PER TOOL FRAME F NC 5220 00 ..
------------------	---	---

F NC 9510 00 03	ISO 30	7	32
F NC 9530 00 03	ISO 40	7	32
F NC 9540 00 03	ISO 45	5	24
F NC 9550 00 03	ISO 50	5	20
F NC 9560 00 03	VDI 30	7	32
F NC 9570 00 03	VDI 40	5	24
F NC 9580 00 03	VDI 50	5	24
F NC 9590 00 03	VDI 60	5	20
F NC 9720 00 03	MORSE TAPER 2	7	32
F NC 9730 00 03	MORSE TAPER 3	7	32
F NC 9740 00 03	MORSE TAPER 4	7	32
F NC 9750 00 03	MORSE TAPER 5	5	24
F NC 9270 00 03	CAPTO C3	7	32
F NC 9275 00 03	CAPTO C4	5	24
F NC 9280 00 03	CAPTO C5	5	24

ORD. NO. TOOL HOLDERS



TOOL HOLDER TYPE	MAX QUANTITY PER TOOL FRAME F NC 5020 00 ..	MAX QUANTITY PER TOOL FRAME F NC 5220 00 ..
------------------	---	---

F NC 9285 00 03	CAPTO C6	5	24
F NC 9290 00 03	CAPTO C8	4	16
F NC 9210 00 03	HSK A32-B40	7	32
F NC 9220 00 03	HSK A40-B50	7	32
F NC 9230 00 03	HSK A50-B63	5	24
F NC 9240 00 03	HSK A63-B80	5	24
F NC 9250 00 03	HSK A80-B100	4	16
F NC 9260 00 03	HSK A100-B125	4	16
F NC 9640 00 03	2"	5	24
F NC 9650 00 03	2" 1/4	5	20
F NC 9010 00 03	58 mm	9	36
F NC 9020 00 03	65 mm	8	32
F NC 9030 00 03	75 mm	7	28
F NC 9040 00 03	87 mm	6	24
F NC 9050 00 03	105 mm	5	20



SHELVING SYSTEM SYSTEM SR 5436

WIDTH = 1020 mm DEPTH = 705 mm (54x36 Eh)

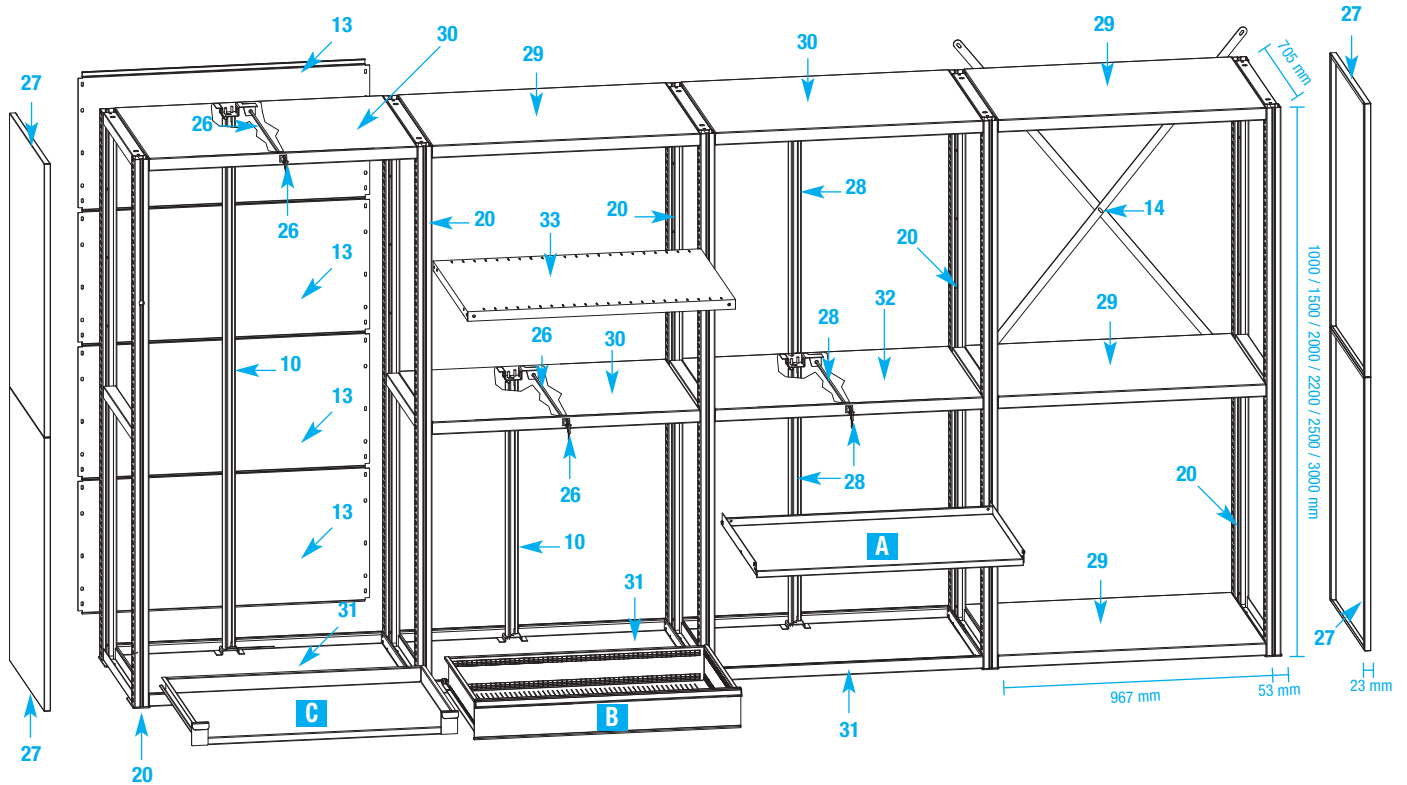

■ Accessories see page F62
 ■ Roller shutters, doors and safety ladders page F63 - F65

FIXING SET

Fixing material including (for 1 upright frame) no. 2 steel floor bolts M10x90 mm for uninterrupted concrete floors equal to or higher than class: B25 / RBK250 / MP_A 25N for mm².

ORD. NO. F SR 8999 00 99

■ Shelving must be fixed to the wall or floor.



LOAD CAPACITY PER BAY

Load capacity per bay kg	For distance between universal or locking shelves mm
4500	2000
5000	1500
5500	1000

REQUIRED QUANTITY OF UNIVERSAL OR LOCKING SHELVES PER BAY

Shelving height mm	Quantity of universal or locking shelves
1000	2
1500	2
2000	2
2200	3
2500	3
3000	3

20 UPRIGHT FRAMES ■ 01 ■ 02 ■ 04 ■ 08

ORD. NO.	DIM. mm
*F SR 0710 01 04	53x705x1000 h
*F SR 0716 01 04	53x705x1500 h
F SR 0720 00 04	53x705x2000 h
F SR 0722 00 04	53x705x2200 h
F SR 0725 00 04	53x705x2500 h
F SR 0730 00 04	53x705x3000 h

*Including cover panels

13 BACK PANELS ■ 01 ■ 02

ORD. NO.	DIM. mm
F SR 2120 00 01	1000 h
F SR 2131 00 01	1500 h
F SR 2140 00 01	2000 h
F SR 2150 00 01	2200 h
F SR 2160 00 01	2500 h
F SR 2170 00 01	3000 h

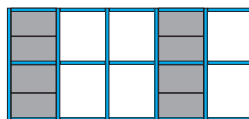

■ A back panel must be fitted to each third bay

14 CROSS BRACINGS ■ 01 ■ 02

ORD. NO.	For shelving height mm
F SR 7120 00 01	1500 / 2200
F SR 7150 00 01	2500 / 3000

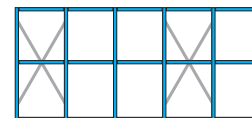

■ A cross bracing must be fitted to each third bay

29 UNIVERSAL SHELVES ■ 01 ■ 02 ■ 04 ■ 08

ORD. NO.	DIM. mm
F SR 1170 00 04	967x705x46 h

Load capacity: 250 kg

33 PERFORATED ADJUSTABLE SHELVES ■ 01 ■ 02 ■ 04 ■ 08

ORD. NO.	DIM. mm
F SR 1370 01 04	967x705x35 h

Load capacity: 250 kg

■ This type of shelf can be fitted only if anti-tilt rod is not fitted

30 TOP LOCKING SHELVES ■ 01 ■ 02 ■ 04 ■ 08

ORD. NO.	DIM. mm
F SR 1570 00 04	967x705x46 h

Load capacity: 200 kg

WIDTH = 1020 mm DEPTH = 705 mm (54x36 Eh)

SHELVING SYSTEM SYSTEM SR 5436

31 BOTTOM LOCKING SHELVES ■ 01 ■ 02 ■ 04 ■ 08

ORD. NO.	DIM. mm
F SR 1670 00 04	967x705x46 h
Load capacity: 200 kg	

32 INTERMEDIATE LOCKING SHELVES ■ 01 ■ 02 ■ 04 ■ 08

ORD. NO.	DIM. mm
F SR 1770 00 04	967x705x46 h
Load capacity: 200 kg	

27 SIDE PANELS ■ 01 ■ 02 ■ 04 ■ 08

ORD. NO.	DIM. mm
F SR 2455 00 04	23x705x1000 h
F SR 2460 00 04	23x705x1100 h
F SR 2465 00 04	23x705x1250 h
F SR 2475 00 04	23x705x1500 h

26 LOCKING SET

ORD. NO.	For shelving depth mm
F SR 8102 00 00	705
Including 1 lock with 2 keys, 1 square rod, 1 anti-tilt rod activation group.	
■ Spare key see page F42	
Spare key (for lock ref. 26)	
ORD. NO. R CSR 0003 00	

28 LOCKING SYSTEM TOTAL HEIGHT ■ 01

ORD. NO.	Rod height mm	For frame height ref. 1 mm
F SR 8310 51 01	900+950 h	2000 h
F SR 8330 51 01	900+1150 h	2200 h
F SR 8350 51 01	900+1450 h	2500 h
F SR 8370 51 01	1400+1450 h	3000 h

10 ANTI-TILT ROD ■ 01

ORD. NO.	Rod height mm
F AG 9116 00 01	300
F AG 9124 00 01	500
F AG 9128 00 01	600
F AG 9132 00 01	700
F AG 9133 00 01	725
F AG 9134 00 01	750
F AG 9140 00 01	900
F AG 9146 00 01	1050
F AG 9150 00 01	1150
F AG 9153 00 01	1225
F AG 9160 00 01	1400
F AG 9165 00 01	1525
F AG 9170 00 01	1650
F AG 9180 00 01	1900

■ It is necessary to fit an anti-tilt rod if drawers or extension shelves are installed

C NORMAL EXTENSION SHELVES (PE-S) ■ 01 ■ 02 ■ 04 ■ 08

ORD. NO.	Usable dim. mm
F FG 8050 00 04	916x610
Side height: -	
Load capacity: 100 kg	
Extension: 87%	

C TELESCOPIC FULL EXTENSION SHELVES (PE-TT) ■ 01 ■ 02 ■ 04 ■ 08

ORD. NO.	Usable dim. mm
F FG 8150 00 04	916x610
Side height: -	
Load capacity: 150 kg	
Extension: 100%	



A ADJUSTABLE SHELVES ■ 01 ■ 02 ■ 04 ■ 08

ORD. NO.	DIM. mm
F SR 1270 01 04	967x618x25 h
Load capacity: 100 kg	

■ This type of shelf can be fitted even if anti-tilt rod is fitted

B NORMAL EXTENSION DRAWERS (S) ■ 01 ■ 02 ■ 04 ■ 08

ORD. NO.	Usable dim. mm	Front height	Load capacity kg	Extension
F FG 5005 00 04	906x600x36 h	50	60	87%
F FG 5007 00 04	906x600x61 h	75	80	87%
F FG 5010 00 04	906x600x86 h	100	100	87%
F FG 5012 00 04	906x600x111 h	125	100	87%

B TELESCOPIC FULL EXTENSION DRAWERS (TT) ■ 01 ■ 02 ■ 04 ■ 08

ORD. NO.	Usable dim. mm	Front height	Load capacity kg	Extension
F FG 5107 00 04	906x600x54 h	75	150	100%
F FG 5110 00 04	906x600x79 h	100	150	100%
F FG 5112 00 04	906x600x104 h	125	150	100%
F FG 5115 00 04	906x600x129 h	150	150	100%
F FG 5117 00 04	906x600x154 h	175	150	100%
F FG 5120 00 04	906x600x179 h	200	150	100%
F FG 5125 00 04	906x600x229 h	250	150	100%
F FG 5130 00 04	906x600x279 h	300	150	100%



■ Set of partitions see page A121



■ Set of partitions see page A121

SHELVING SYSTEM SYSTEM SR 6436

WIDTH = 1190 mm DEPTH = 705 mm (64x36 Eh)

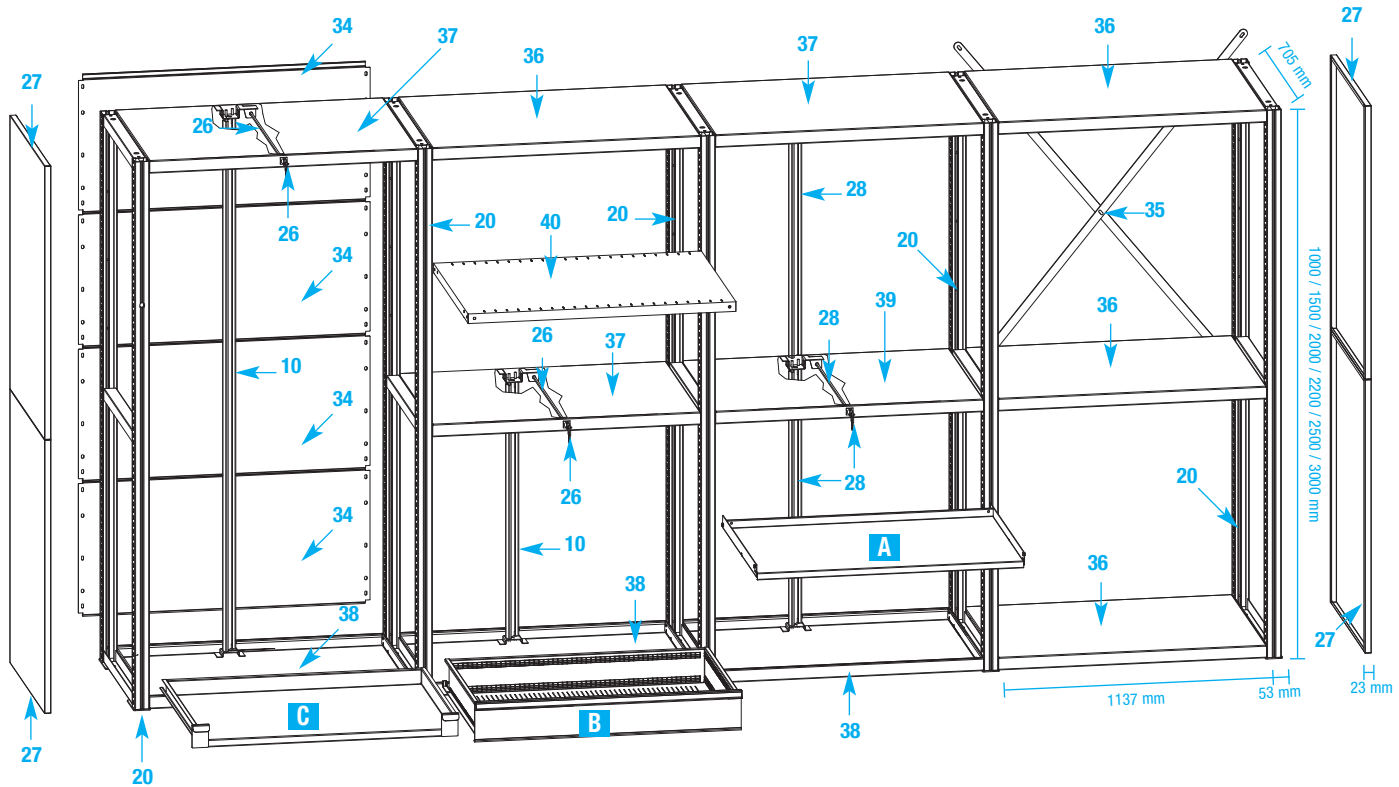

- Accessories see page F62
- Roller shutters, doors and safety ladders page F63 - F65

FIXING SET

Fixing material including (for 1 upright frame) no. 2 steel floor bolts M10x90 mm for uninterrupted concrete floors equal to or higher than class: B25 / RBK250 / MP_A 25N for mm².

ORD. NO. F SR 8999 00 99

- Shelving must be fixed to the wall or floor.



LOAD CAPACITY PER BAY

Load capacity per bay kg	For distance between universal or locking shelves mm
4500	2000
5000	1500
5500	1000

REQUIRED QUANTITY OF UNIVERSAL OR LOCKING SHELVES PER BAY

Shelving height mm	Quantity of universal or locking shelves
1000	2
1500	2
2000	2
2200	3
2500	3
3000	3

20 UPRIGHT FRAMES ■ 01 ■ 02 ■ 04 ■ 08

ORD. NO.	DIM. mm
*F SR 0710 01 04	53x705x1000 h
*F SR 0716 01 04	53x705x1500 h
F SR 0720 00 04	53x705x2000 h
F SR 0722 00 04	53x705x2200 h
F SR 0725 00 04	53x705x2500 h
F SR 0730 00 04	53x705x3000 h

*Including cover panels

34 BACK PANELS ■ 01 ■ 02

ORD. NO.	DIM. mm
F SR 2220 00 01	1000 h
F SR 2231 00 01	1500 h
F SR 2240 00 01	2000 h
F SR 2250 00 01	2200 h
F SR 2260 00 01	2500 h
F SR 2270 00 01	3000 h

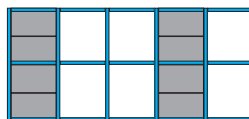

■ A back panel must be fitted to each third bay

35 CROSS BRACINGS ■ 01 ■ 02

ORD. NO.	For shelving height mm
F SR 7220 00 01	1500 / 2200
F SR 7250 00 01	2500 / 3000

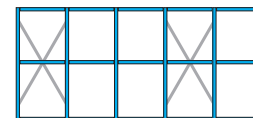

■ A cross bracing must be fitted to each third bay

36 UNIVERSAL SHELVES ■ 01 ■ 02 ■ 04 ■ 08

ORD. NO.	DIM. mm
F SR 1180 00 04	1137x705x46 h

Load capacity: 250 kg

40 PERFORATED ADJUSTABLE SHELVES ■ 01 ■ 02 ■ 04 ■ 08

ORD. NO.	DIM. mm
F SR 1380 01 04	1137x705x35 h

Load capacity: 300 kg

■ This type of shelf can be fitted only if anti-tilt rod is not fitted

37 TOP LOCKING SHELVES ■ 01 ■ 02 ■ 04 ■ 08

ORD. NO.	DIM. mm
F SR 1580 00 04	1137x705x46 h

Load capacity: 200 kg

WIDTH = 1190 mm DEPTH = 705 mm (64x36 Eh)

SHELVING SYSTEM SYSTEM SR 6436

38 BOTTOM LOCKING SHELVES ■ 01 ■ 02 ■ 04 ■ 08

ORD. NO.	DIM. mm
F SR 1680 00 04	1137x705x46 h
Load capacity: 200 kg	

39 INTERMEDIATE LOCKING SHELVES ■ 01 ■ 02 ■ 04 ■ 08

ORD. NO.	DIM. mm
F SR 1780 00 04	1137x705x46 h
Load capacity: 200 kg	

27 SIDE PANELS ■ 01 ■ 02 ■ 04 ■ 08

ORD. NO.	DIM. mm
F SR 2455 00 04	23x705x1000 h
F SR 2460 00 04	23x705x1100 h
F SR 2465 00 04	23x705x1250 h
F SR 2475 00 04	23x705x1500 h

26 LOCKING SET

ORD. NO.	For shelving depth mm
F SR 8102 00 00	705
Including 1 lock with 2 keys, 1 square rod, 1 anti-tilt rod activation group.	
■ Spare key see page F42	
Spare key (for lock ref. 26)	
ORD. NO. R CSR 0003 00	

28 LOCKING SYSTEM TOTAL HEIGHT ■ 01

ORD. NO.	Rod height mm	For frame height ref. 1 mm
F SR 8310 51 01	900+950 h	2000 h
F SR 8330 51 01	900+1150 h	2200 h
F SR 8350 51 01	900+1450 h	2500 h
F SR 8370 51 01	1400+1450 h	3000 h

10 ANTI-TILT ROD ■ 01

ORD. NO.	Rod height mm
F AG 9116 00 01	300
F AG 9124 00 01	500
F AG 9128 00 01	600
F AG 9132 00 01	700
F AG 9133 00 01	725
F AG 9134 00 01	750
F AG 9140 00 01	900
F AG 9146 00 01	1050
F AG 9150 00 01	1150
F AG 9153 00 01	1225
F AG 9160 00 01	1400
F AG 9165 00 01	1525
F AG 9170 00 01	1650
F AG 9180 00 01	1900

■ It is necessary to fit an anti-tilt rod if drawers or extension shelves are installed



C TELESCOPIC FULL EXTENSION SHELVES (PE-TT) ■ 01 ■ 02 ■ 04 ■ 08

ORD. NO.	Usable dim. mm
F FG 8160 00 04	1086x610
Side height: -	
Load capacity: 150 kg	
Extension: 100%	

A ADJUSTABLE SHELVES ■ 01 ■ 02 ■ 04 ■ 08

ORD. NO.	DIM. mm
F SR 1280 01 04	1137x618x35 h
Load capacity: 150 kg	
■ This type of shelf can be fitted even if anti-tilt rod is fitted	

B TELESCOPIC FULL EXTENSION DRAWERS (TT) ■ 01 ■ 02 ■ 04 ■ 08

ORD. NO.	Usable dim. mm	Front height	Load capacity kg	Extension
F FG 6107 00 04	1076x600x54 h	75	150	100%
F FG 6110 00 04	1076x600x79 h	100	150	100%
F FG 6112 00 04	1076x600x104 h	125	150	100%
F FG 6115 00 04	1076x600x129 h	150	150	100%
F FG 6120 00 04	1076x600x179 h	200	150	100%
F FG 6125 00 04	1076x600x229 h	250	150	100%
F FG 6130 00 04	1076x600x279 h	300	150	100%



■ Set of partitions see page **A129**

SHELVING SYSTEM SYSTEM SR 7836

WIDTH = 1428 mm DEPTH = 705 mm (78x36 Eh)

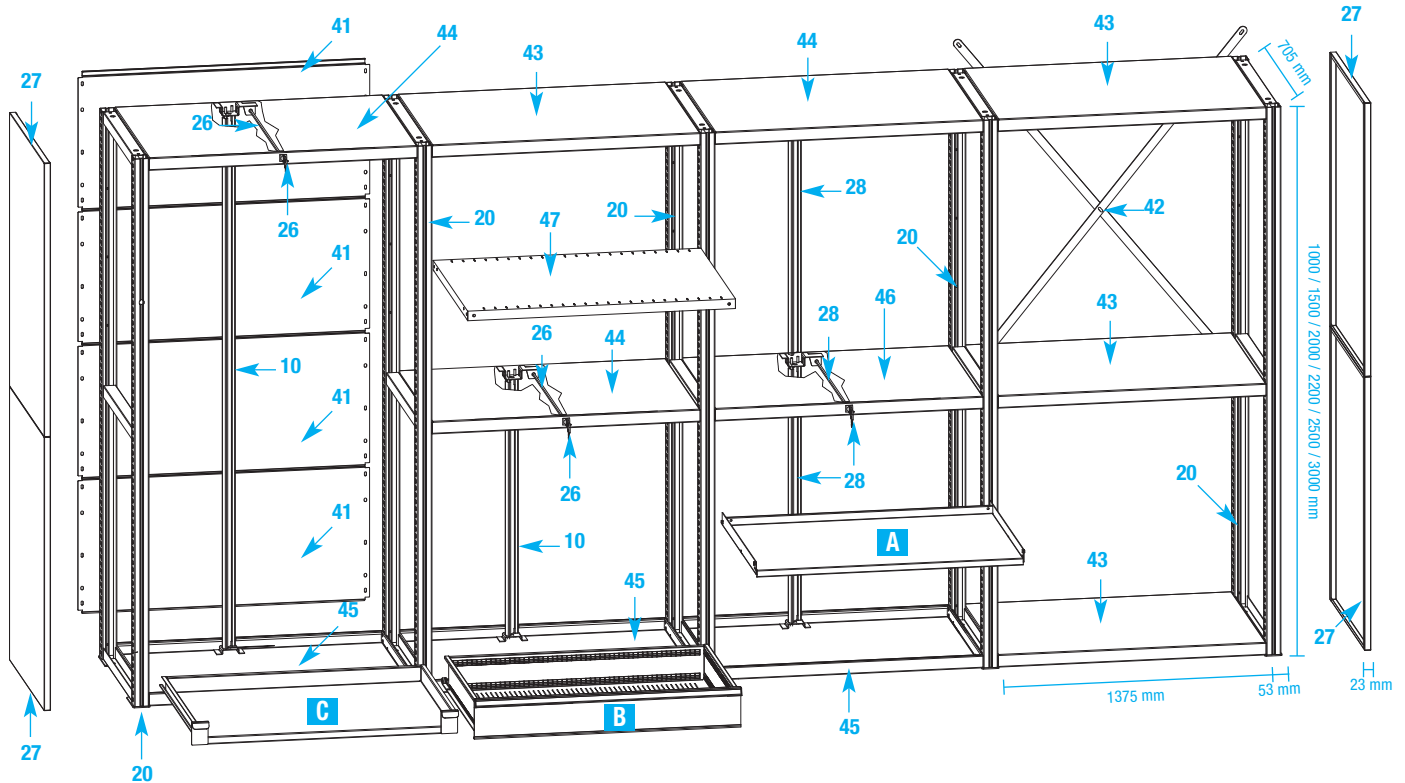

- Accessories see page F62
- Roller shutters, doors and safety ladders page F63 - F65

FIXING SET

Fixing material including (for 1 upright frame) no. 2 steel floor bolts M10x90 mm for uninterrupted concrete floors equal to or higher than class: B25 / RBK250 / MP_A 25N for mm².

ORD. NO. F SR 8999 00 99

- Shelving must be fixed to the wall or floor.

LOAD CAPACITY PER BAY

Load capacity per bay kg	For distance between universal or locking shelves mm
4500	2000
5000	1500
5500	1000

REQUIRED QUANTITY OF UNIVERSAL OR LOCKING SHELVES PER BAY

Shelving height mm	Quantity of universal or locking shelves
1000	2
1500	2
2000	2
2200	3
2500	3
3000	3

20 UPRIGHT FRAMES ■ 01 ■ 02 ■ 04 ■ 08

ORD. NO.	DIM. mm
*F SR 0710 01 04	53x705x1000 h
*F SR 0716 01 04	53x705x1500 h
F SR 0720 00 04	53x705x2000 h
F SR 0722 00 04	53x705x2200 h
F SR 0725 00 04	53x705x2500 h
F SR 0730 00 04	53x705x3000 h

*Including cover panels

41 BACK PANELS ■ 01 ■ 02

ORD. NO.	DIM. mm
F SR 2320 00 01	1000 h
F SR 2331 00 01	1500 h
F SR 2340 00 01	2000 h
F SR 2350 00 01	2200 h
F SR 2360 00 01	2500 h
F SR 2370 00 01	3000 h

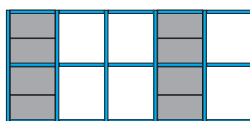

- A back panel must be fitted to each third bay

42 CROSS BRACINGS ■ 01 ■ 02

ORD. NO.	For shelving height mm
F SR 7320 00 01	1500 / 2200
F SR 7350 00 01	2500 / 3000

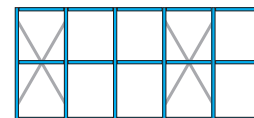

- A cross bracing must be fitted to each third bay

43 UNIVERSAL SHELVES ■ 01 ■ 02 ■ 04 ■ 08

ORD. NO.	DIM. mm
F SR 1190 00 04	1375x705x46 h

Load capacity: 250 kg

47 PERFORATED ADJUSTABLE SHELVES ■ 01 ■ 02 ■ 04 ■ 08

ORD. NO.	DIM. mm
F SR 1390 01 04	1375x705x35 h

Load capacity: 300 kg

- This type of shelf can be fitted only if anti-tilt rod is not fitted

44 TOP LOCKING SHELVES ■ 01 ■ 02 ■ 04 ■ 08

ORD. NO.	DIM. mm
F SR 1590 00 04	1375x705x46 h

Load capacity: 200 kg

WIDTH = 1428 mm DEPTH = 705 mm (78x36 Eh)

SHELVING SYSTEM SYSTEM SR 7836

45 BOTTOM LOCKING SHELVES ■ 01 ■ 02 ■ 04 ■ 08

ORD. NO.	DIM. mm
F SR 1690 00 04	1375x705x46 h
Load capacity: 200 kg	

46 INTERMEDIATE LOCKING SHELVES ■ 01 ■ 02 ■ 04 ■ 08

ORD. NO.	DIM. mm
F SR 1790 00 04	1375x705x46 h
Load capacity: 200 kg	

27 SIDE PANELS ■ 01 ■ 02 ■ 04 ■ 08

ORD. NO.	DIM. mm
F SR 2455 00 04	23x705x1000 h
F SR 2460 00 04	23x705x1100 h
F SR 2465 00 04	23x705x1250 h
F SR 2475 00 04	23x705x1500 h

26 LOCKING SET

ORD. NO.	For shelving depth mm
F SR 8102 00 00	705
Including 1 lock with 2 keys, 1 square rod, 1 anti-tilt rod activation group.	
■ Spare key see page F42	
Spare key (for lock ref. 26)	
ORD. NO. R CSR 0003 00	

28 LOCKING SYSTEM TOTAL HEIGHT ■ 01

ORD. NO.	Rod height mm	For frame height ref. 1 mm
F SR 8310 51 01	900+950 h	2000 h
F SR 8330 51 01	900+1150 h	2200 h
F SR 8350 51 01	900+1450 h	2500 h
F SR 8370 51 01	1400+1450 h	3000 h

10 ANTI-TILT ROD ■ 01

ORD. NO.	Rod height mm
F AG 9116 00 01	300
F AG 9124 00 01	500
F AG 9128 00 01	600
F AG 9132 00 01	700
F AG 9133 00 01	725
F AG 9134 00 01	750
F AG 9140 00 01	900
F AG 9146 00 01	1050
F AG 9150 00 01	1150
F AG 9153 00 01	1225
F AG 9160 00 01	1400
F AG 9165 00 01	1525
F AG 9170 00 01	1650
F AG 9180 00 01	1900

■ It is necessary to fit an anti-tilt rod if drawers or extension shelves are installed



C TELESCOPIC FULL EXTENSION SHELVES (PE-TT) ■ 01 ■ 02 ■ 04 ■ 08

ORD. NO.	Usable dim. mm
F FG 8170 00 04	1324x610
Side height: -	
Load capacity: 150 kg	
Extension: 100%	

A ADJUSTABLE SHELVES ■ 01 ■ 02 ■ 04 ■ 08

ORD. NO.	DIM. mm
F SR 1290 01 04	1375x618x35 h
Load capacity: 150 kg	
■ This type of shelf can be fitted even if anti-tilt rod is fitted	

B TELESCOPIC FULL EXTENSION DRAWERS (TT) ■ 01 ■ 02 ■ 04 ■ 08

ORD. NO.	Usable dim. mm	Front height	Load capacity kg	Extension
F FG 7107 00 04	1314x600x54 h	75	150	100%
F FG 7110 00 04	1314x600x79 h	100	150	100%
F FG 7112 00 04	1314x600x104 h	125	150	100%
F FG 7115 00 04	1314x600x129 h	150	150	100%
F FG 7117 00 04	1314x600x154 h	175	150	100%
F FG 7120 00 04	1314x600x179 h	200	150	100%
F FG 7125 00 04	1314x600x229 h	250	150	100%
F FG 7130 00 04	1314x600x279 h	300	150	100%



■ Set of partitions see page **A137**

SHELVING SYSTEM SYSTEM SR 0705

COVER PANELS

■ 01 ■ 02
■ 04 ■ 08

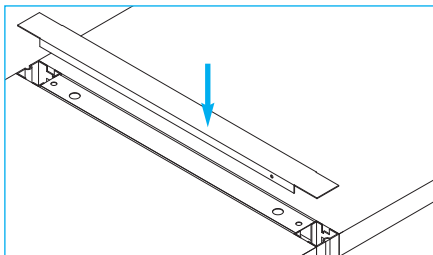

ORD. NO.

F SR 2560 00 04

For shelving depth 705 mm

INFIL PANELS

■ 01 ■ 02
■ 04 ■ 08

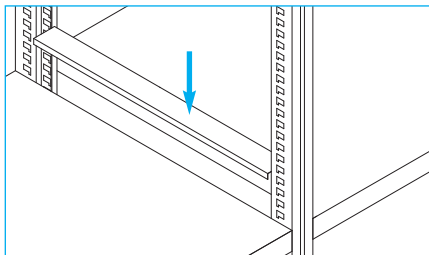

ORD. NO.

F SR 2760 00 04

For shelving depth 705 mm

SHELF SIDE PANELS

■ 01 ■ 02

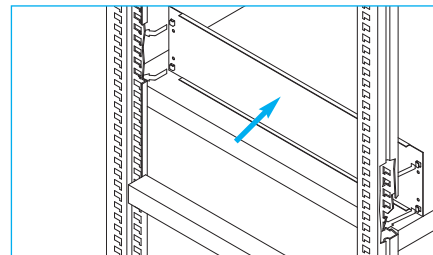

ORD. NO.

HEIGHT mm h

F SR 2660 00 01

150

F SR 2670 00 01

200

F SR 2680 00 01

250

For shelving depth 705 mm

PARTITIONS

■ 01 ■ 02

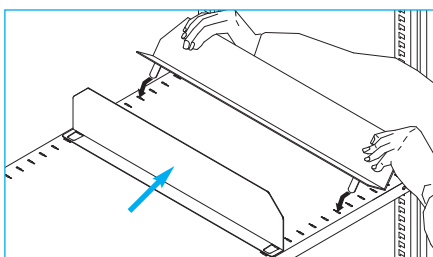

ORD. NO.

HEIGHT mm h

F SR 2860 00 01

95

F SR 2880 00 01

145

F SR 2890 00 01

195

For shelving depth 705 mm

HOOK



■ 99

ORD. NO.

F SL 1910 00 99

Galvanised hook for adjustable shelf

DRAWING POCKETS



ORD. NO.

DIMENSIONS mm

C MV 15 005

332x210 h DIN A4

C MV 15 006

218x148 h DIN A5

MAGNETIC SUPPORT WITH LABEL



ORD. NO.

F ST 9997 00 00Magnetic support with label and cellophane
Length 1000 mm

ORD. NO.

R FST 0007 00

Spare label and cellophane (100 pcs)

MULTIPLEX WORKTOP

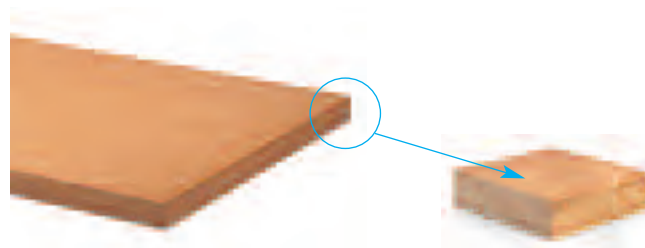

ORD. NO.

DIMENSIONS mm

F SR 0070 00 00

967x705x40 h

F SR 0080 00 00

1137x705x40 h

F SR 0090 00 00

1375x705x40 h



Using the Multiplex worktop

ROLLER SHUTTER FOR UNIVERSAL SHELVING SYSTEM SERIES SR

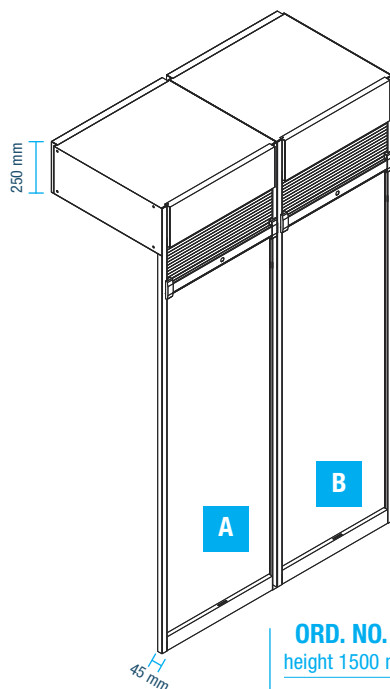

■ It is not possible to fit a roller shutter on shelving with vertical drawers 1715/1915/2215 mm high.

■ It is not possible to fit a roller shutter if the next bay is fitted with sliding doors or leaf doors

■ Spare key see page F42

Spare lock (for roller shutters)

ORD. NO. R CSR 0006 00

■ 01 ■ 02 ■ 04 ■ 08

ORD. NO. height 1500 mm h	ORD. NO. height 2000 mm h	ORD. NO. height 2200 mm h	ORD. NO. height 2500 mm h	DOOR TYPE
F SR 6022 00 04	F SR 6030 00 04	F SR 6040 00 04	F SR 6050 00 04	Single roller shutter 36 Eh (A)
F SR 6023 00 04	F SR 6031 00 04	F SR 6041 00 04	F SR 6051 00 04	Add-on unit 36 Eh (B)
F SR 6122 00 04	F SR 6130 00 04	F SR 6140 00 04	F SR 6150 00 04	Single roller shutter 54 Eh (A)
F SR 6123 00 04	F SR 6131 00 04	F SR 6141 00 04	F SR 6151 00 04	Add-on unit 54 Eh (B)
F SR 6222 00 04	F SR 6230 00 04	F SR 6240 00 04	F SR 6250 00 04	Single roller shutter 64 Eh (A)
F SR 6223 00 04	F SR 6231 00 04	F SR 6241 00 04	F SR 6251 00 04	Add-on unit 64 Eh (B)
F SR 6322 00 04	F SR 6330 00 04	F SR 6340 00 04	F SR 6350 00 04	Single roller shutter 2x36 Eh (A)
F SR 6323 00 04	F SR 6331 00 04	F SR 6341 00 04	F SR 6351 00 04	Add-on unit 2x36 Eh (B)
F SR 6422 00 04	F SR 6430 00 04	F SR 6440 00 04	F SR 6450 00 04	Single roller shutter 78 Eh (A)
F SR 6423 00 04	F SR 6431 00 04	F SR 6441 00 04	F SR 6451 00 04	Add-on unit 78 Eh (B)

Complete with safety lock and 2 keys

SIDE PANELS FOR SHELVING WITH ROLLER SHUTTER

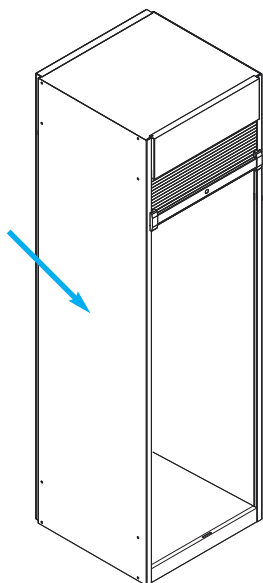

■ 01 ■ 02 ■ 04 ■ 08

ORD. NO. left hand side	ORD. NO. right hand side	FRAME HEIGHT mm	SIDE PANELS HEIGHT (with roller shutter mm)
F SR 6623 00 04	F SR 6622 00 04	1500	1750
F SR 6631 00 04	F SR 6630 00 04	2000	2250
F SR 6641 00 04	F SR 6640 00 04	2200	2450
F SR 6651 00 04	F SR 6650 00 04	2500	2750

For universal shelving 553 mm depth

■ 01 ■ 02 ■ 04 ■ 08

ORD. NO. left hand side	ORD. NO. right hand side	FRAME HEIGHT mm	SIDE PANELS HEIGHT (with roller shutter mm)
F SR 6723 00 04	F SR 6722 00 04	1500	1750
F SR 6731 00 04	F SR 6730 00 04	2000	2250
F SR 6741 00 04	F SR 6740 00 04	2200	2450
F SR 6751 00 04	F SR 6750 00 04	2500	2750

For universal shelving 705 mm depth

SHELVING SYSTEM SYSTEM SR 1000

WIDTH = 780/1020 mm (36/54 Eh)

LEAF DOORS 780 mm WIDTH (36 Eh)

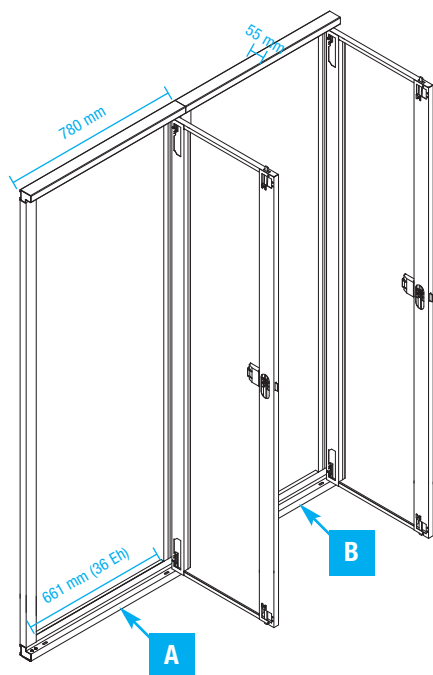

■ 01 ■ 02 ■ 04 ■ 08

ORD. NO.

height 2000 mm h

DOOR TYPE

F SR 5030 00 04

Single door 36 Eh (A)

F SR 5031 00 04

Add-on unit 36 Eh (B)

Complete with safety lock and 2 keys

■ It is not possible to fit a leaf door on shelving with vertical drawers 1715/1915/2215 mm high

■ It is not possible to fit leaf doors if the next bay is fitted with sliding doors or roller shutter

Spare lock (for leaf doors)

ORD. NO. R CSR 0008 00

LEAF DOORS 1020 mm WIDTH (54 Eh)

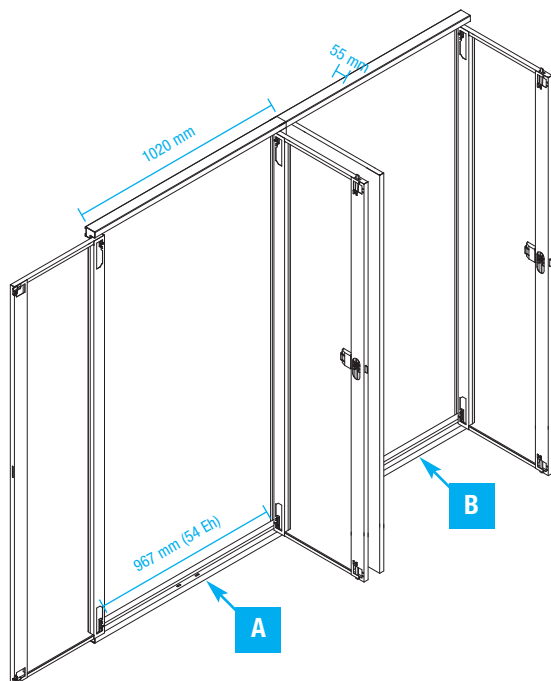

■ 01 ■ 02 ■ 04 ■ 08

ORD. NO.

height 1000 mm h

ORD. NO.

height 2000 mm h

DOOR TYPE

F SR 5310 00 04**F SR 5330 00 04**

Single door 36 Eh (A)

F SR 5311 00 04**F SR 5331 00 04**

Add-on unit 36 Eh (B)

Complete with safety lock and 2 keys

■ It is not possible to fit a leaf door on shelving with vertical drawers 1715/1915/2215 mm high

■ It is not possible to fit leaf doors if the next bay is fitted with sliding doors or roller shutter

Spare lock (for leaf doors)

ORD. NO. R CSR 0011 00

RAL 7000 F.01

RAL 6011 F.02

RAL 5012 F.04

RAL 7035 F.08

SUPPLEMENTARY PARTS ■

■ **Spare key.** Always indicate the number on the cylinder lock of the key to be replaced.

ORD. NO. R CSC 0002 00

■ **Master key.** This type of key opens all the 45 and 46 series locks.

ORD. NO. R CSC 0001 00



SHELVING SYSTEM SYSTEM SR 1000

SLIDING DOORS

ORD. NO. height 2000 mm h	ORD. NO. height 2200 mm h	ORD. NO. height 2500 mm h	DOOR TYPE
F SR 5530 00 04	F SR 5540 00 04	F SR 5550 00 04	Single door 2x36 Eh (A)
F SR 5531 00 04	F SR 5541 00 04	F SR 5551 00 04	Add-on unit 2x36 Eh (B)
F SR 5630 00 04	F SR 5640 00 04	F SR 5650 00 04	Single door 2x54 Eh (A)
F SR 5631 00 04	F SR 5641 00 04	F SR 5651 00 04	Add-on unit 2x54 Eh (B)
F SR 5730 00 04	-	-	Single door 2x64 Eh (A)
F SR 5731 00 04	-	-	Add-on unit 2x64 Eh (B)
F SR 5830 00 04	-	-	Single door 2x78 Eh (A)
F SR 5831 00 04	-	-	Add-on unit 2x78 Eh (B)

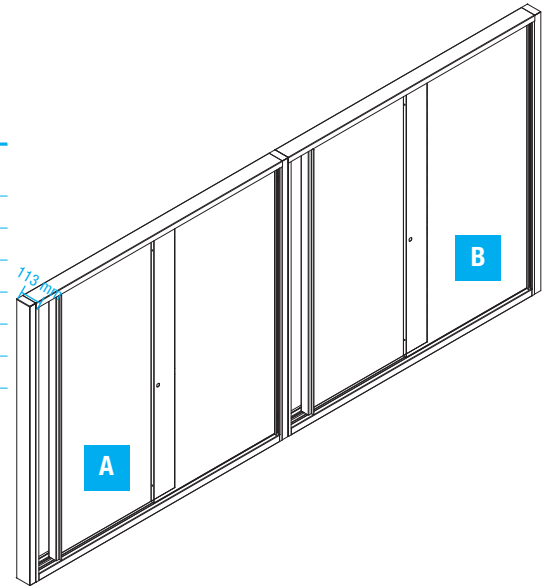

- It is not possible to fit a leaf door on shelving with vertical drawers 1715/1915/2215 mm high
- It is not possible to fit sliding doors if the next bay is fitted with leaf doors or roller shutter

■ Spare key see page F64

Spare lock (for sliding doors) **ORD. NO. R CSR 0012 00**

SAFETY LADDERS

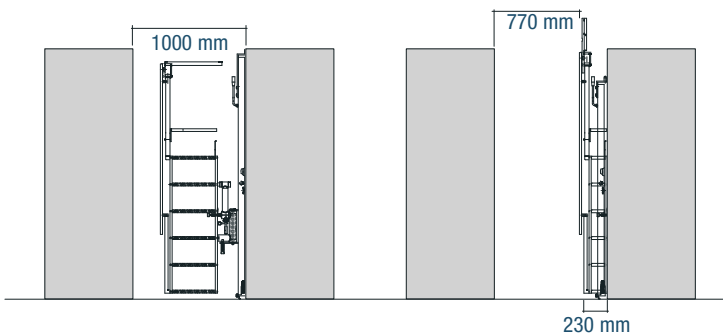

ORD. NO. (A)	FOR SHELVING HEIGHT mm
F QG 6220 00 30	2200
F QG 6250 00 30	2500
F QG 6300 00 30	3000

ORD. NO.	01	02	04	08
F QG 9600 00 04				
Upper and lower guide rails per linear meter				
Guide rails for shelving without doors				

ORD. NO.	01	02	04	08
F QG 9601 00 04				
Upper and lower guide rails per linear meter				
Guide rails for shelving with leaf doors				

ORD. NO.	01	02	04	08
F QG 9602 00 04				
Upper and lower guide rails per linear meter				
Guide rails for shelving with sliding doors				

■ INFO

RAL 7000 F.01 RAL 6011 F.02 RAL 5012 F.04 RAL 7035 F.08



www.famispaspa.com

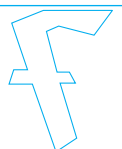

SHELVING SYSTEM SYSTEM SR V1

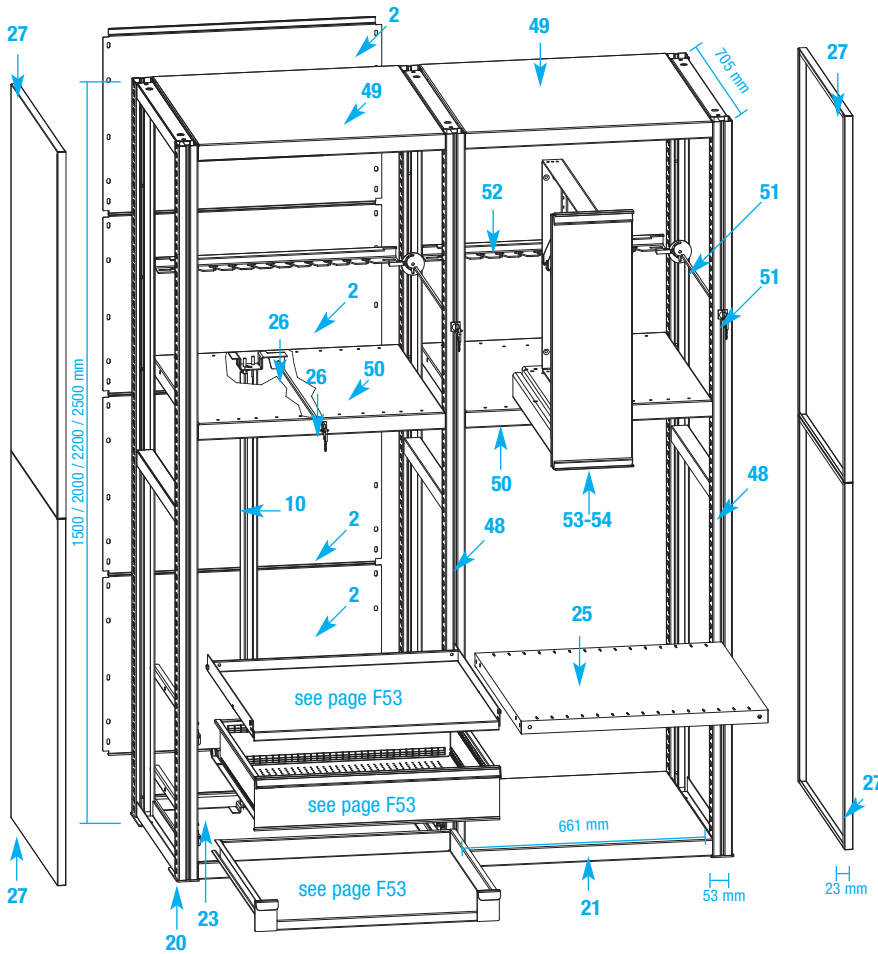

- Accessories see page F62
- Roller shutters, doors and safety ladders page F63 - F65
- Shelving must be fixed to the wall or floor.
- Further information for fixing set and load capacity see page F52

26 LOCKING SET

ORD. NO.	For shelving depth mm
F SR 8102 00 00	705
Including 1 lock with 2 keys, 1 square rod, 1 anti-tilt rod activation group.	
■ Spare key see page F64	
■ Spare key (for lock ref. 26)	
ORD. NO. R CSR 0003 00	

10 ANTI-TILT ROD

ORD. NO.	ROD HEIGHT mm
F AG 9128 00 01	600
F AG 9150 00 01	1150
F AG 9158 00 01	1400
F AG 9170 00 01	1650
■ It is necessary to fit an anti-tilt rod if drawers or extension shelves are installed	

50 BOTTOM SHELVES FOR VERTICAL DRAWERS

ORD. NO.	DIM. mm
F SR 4100 00 04	661x705x46 h
Load capacity: 400 kg	

51+52 LOCKING SET

ORD. NO.	WIDTH mm
F SR 4060 00 01	661
Including 1 lock with 2 keys, 1 square rod, 1 anti-tilt rod activation group	
■ Spare key (for lock ref. 51)	
ORD. NO. R CSR 0003 00	
■ Spare key see page F64	

52 ANTI-TILT ROD

ORD. NO.	WIDTH mm
F SR 4010 00 01	661
■ It is necessary to fit an anti-tilt rod if drawers are installed	

49 TOP SHELVES FOR VERTICAL DRAWERS

ORD. NO.	DIM. mm
F SR 4150 00 04	661x705x46 h
Load capacity: 200 kg	

20 UPRIGHT FRAMES

ORD. NO.	DIM. mm
*F SR 0716 01 04	53x705x1500 h
F SR 0720 00 04	53x705x2000 h
F SR 0722 00 04	53x705x2200 h
F SR 0725 00 04	53x705x2500 h

*Including cover panels

48 UPRIGHT FRAMES WITH HOLE FOR LOCK

ORD. NO.	DIM. mm
F SR 0721 01 04	53x705x2000 h
F SR 0723 01 04	53x705x2200 h
F SR 0726 01 04	53x705x2500 h

Upright frames with hole for lock for vertical drawers

2 BACK PANELS

ORD. NO.	DIM. mm
F SR 2040 00 01	2000 h
F SR 2050 00 01	2200 h
F SR 2060 00 01	2500 h

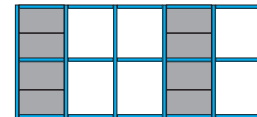

■ A back panel must be fitted to each third bay

27 SIDE PANELS

ORD. NO.	DIM. mm
F SR 2455 01 04	23x705x1000 h
F SR 2460 01 04	23x705x1100 h
F SR 2465 01 04	23x705x1250 h
F SR 2475 01 04	23x705x1500 h

21 UNIVERSAL SHELVES

ORD. NO.	DIM. mm
F SR 1160 00 04	661x705x46 h
Load capacity: 250 kg	

25 PERFORATED ADJUSTABLE SHELVES

ORD. NO.	DIM. mm
F SR 1360 01 04	661x705x35 h
Load capacity: 300 kg	
■ This type of shelf can be fitted only if the anti-tilt rod is not fitted	

23 BOTTOM LOCKING SHELVES

ORD. NO.	DIM. mm
F SR 1660 00 04	661x705x46 h
Load capacity: 200 kg	

WIDTH = 714 mm DEPTH = 705 mm (36x36 Eh)

SHELVING SYSTEM SYSTEM SR V1

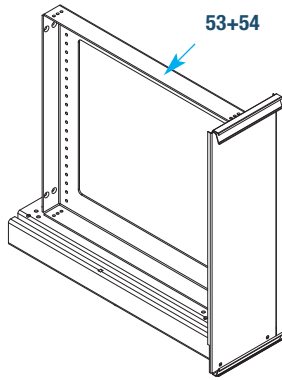

53 VERTICAL DRAWERS
1 SIDE STORAGE

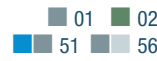

ORD. NO.	DIM. mm
F SR 3055 00 51	220x700 h
Load capacity: 100 kg	
Vertical drawers for shelving 705 mm depth	

54 VERTICAL DRAWERS
2 SIDES STORAGE

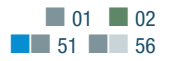

ORD. NO.	DIM. mm
F SR 3555 00 51	220x700 h
F SR 3570 00 51	330x700 h
Load capacity: 100 kg	
Vertical drawers for shelving 705 mm depth	

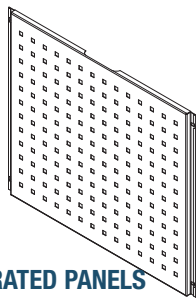

PERFORATED PANELS



ORD. NO.	DIM. mm
F SR 4210 00 01	620x500 h
For vertical drawers for 1 or 2 side storage	

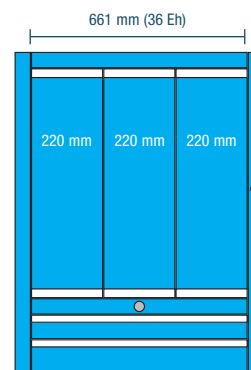
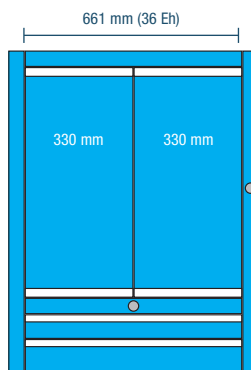

REQUIREMENTS FOR VERTICAL DRAWERS AND TOOL HANGING FRAMES

ORD. NO. DRAWERS 1 SIDE (A)	ORD. NO. TOOL HANGING FRAME (B)	FRONT WIDTH mm	FOR TOOLS	Ø MAX. mm	TOOLS Q.TY
F SR 3055 00 51	F CN 3240 00 01	220	ISO 50	112/80	5
F SR 3055 00 51	F CN 3260 00 01	220	ISO 55	130/89	4
F SR 3055 00 51	F CN 3270 00 01	220	ISO 60	160/109	3

ORD. NO. DRAWERS 2 SIDES (A)	ORD. NO. TOOL HANGING FRAME (B)	FRONT WIDTH mm	FOR TOOLS	Ø MAX. mm	TOOLS Q.TY
F SR 3555 00 51	F CN 3210 00 01	220	ISO 40	63/50	9
F SR 3555 00 51	F CN 3220 00 01	220	ISO 45	82/63	7
F SR 3555 00 51	F CN 3250 00 01	220	ISO 50	98/80	6
F SR 3570 00 51	F CN 3240 00 01	330	ISO 50	112/80	5
F SR 3570 00 51	F CN 3260 00 01	330	ISO 55	130/89	4
F SR 3570 00 51	F CN 3270 00 01	330	ISO 60	160/109	3

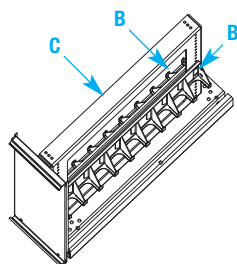
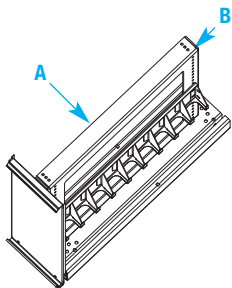

TOOL HANGING FRAME



ORD. NO.	FOR TOOLS	FLANGE Ø MAX. mm	SHANK Ø MAX. mm	TOOLS Q.TY	WIDTH mm	DEPTH mm
F CN 3210 00 01	ISO 40	63	50	9	597	56
F CN 3220 00 01	ISO 45	82	63	7	597	75
F CN 3230 00 01	ISO 50	98	80	5	597	84
F CN 3240 00 01	ISO 50	112	80	5	597	100
F CN 3250 00 01	ISO 50	98	80	6	623	84
F CN 3260 00 01	ISO 55	130	89	4	597	120
F CN 3270 00 01	ISO 60	160	109	3	597	140



SHELVING SYSTEM SYSTEM SR V2

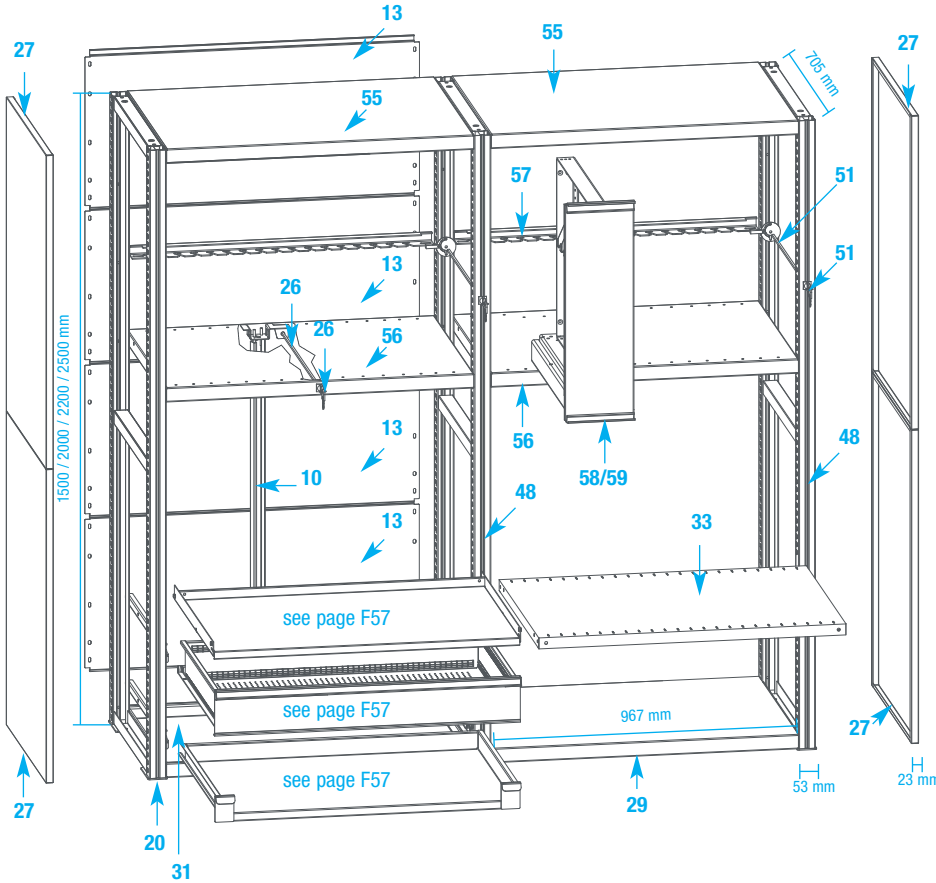

- Accessories see page F62
- Roller shutters, doors and safety ladders page F63 - F65
- Shelving must be fixed to the wall or floor.
- Further information for fixing set and load capacity see page F52

26 LOCKING SET

ORD. NO.	For shelving depth mm
F SR 8102 00 00	705
Including 1 lock with 2 keys, 1 square rod, 1 anti-tilt rod activation group.	
■ Spare key see page F64	
■ Spare key (for lock ref. 26)	
ORD. NO. R CSR 0003 00	

10 ANTI-TILT ROD

ORD. NO.	ROD HEIGHT mm
F AG 9128 00 01	600
F AG 9150 00 01	1150
F AG 9158 00 01	1400
F AG 9170 00 01	1650
■ It is necessary to fit an anti-tilt rod if drawers or extension shelves are installed	

56 BOTTOM SHELVES FOR VERTICAL DRAWERS

ORD. NO.	DIM. mm
F SR 4105 00 04	967x705x46 h
Load capacity: 400 kg	

51+57 LOCKING SET

ORD. NO.	WIDTH mm
F SR 4070 00 01	967
Including 1 lock with 2 keys, 1 square rod, 1 anti-tilt rod activation group	
■ Spare key (for lock ref. 51)	
ORD. NO. R CSR 0003 00	
■ Spare key see page F64	

57 ANTI-TILT ROD

ORD. NO.	WIDTH mm
F SR 4020 00 01	967
■ It is necessary to fit an anti-tilt rod if drawers are installed	

55 TOP SHELVES FOR VERTICAL DRAWERS

ORD. NO.	DIM. mm
F SR 4155 00 04	967x705x46 h
Load capacity: 200 kg	

20 UPRIGHT FRAMES

ORD. NO.	DIM. mm
*F SR 0716 01 04	53x705x1500 h
F SR 0720 00 04	53x705x2000 h
F SR 0722 00 04	53x705x2200 h
F SR 0725 00 04	53x705x2500 h

*Including cover panels

48 UPRIGHT FRAMES WITH HOLE FOR LOCK

ORD. NO.	DIM. mm
F SR 0721 01 04	53x705x2000 h
F SR 0723 01 04	53x705x2200 h
F SR 0726 01 04	53x705x2500 h

Upright frames with hole for lock for vertical drawers

13 BACK PANELS

ORD. NO.	DIM. mm
F SR 2140 00 01	2000 h
F SR 2150 00 01	2200 h
F SR 2160 00 01	2500 h

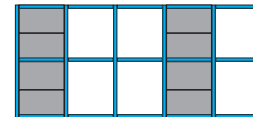

■ A back panel must be fitted to each third bay

27 SIDE PANELS

ORD. NO.	DIM. mm
F SR 2455 01 04	23x705x1000 h
F SR 2460 01 04	23x705x1100 h
F SR 2465 01 04	23x705x1250 h
F SR 2475 01 04	23x705x1500 h

29 UNIVERSAL SHELVES

ORD. NO.	DIM. mm
F SR 1170 00 04	967x705x46 h
Load capacity: 250 kg	

33 PERFORATED ADJUSTABLE SHELVES

ORD. NO.	DIM. mm
F SR 1370 01 04	967x705x35 h
Load capacity: 250 kg	
■ This type of shelf can be fitted only if the anti-tilt rod is not fitted	

31 BOTTOM LOCKING SHELVES

ORD. NO.	DIM. mm
F SR 1670 00 04	967x705x46 h
Load capacity: 200 kg	

WIDTH = 1020 mm DEPTH = 705 mm (54x36 Eh)

SHELVING SYSTEM SYSTEM SR V2

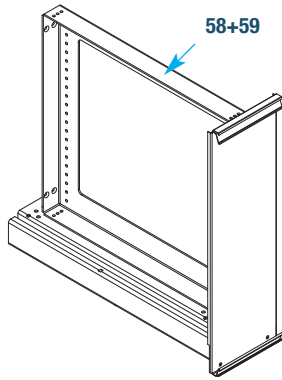

58 VERTICAL DRAWERS 1 SIDE STORAGE

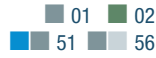

ORD. NO.	DIM. mm
F SR 3060 00 51	240x700 h
Load capacity: 100 kg	
Vertical drawers for shelving 705 mm depth	

59 VERTICAL DRAWERS 2 SIDES STORAGE

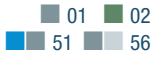

ORD. NO.	DIM. mm
F SR 3560 00 51	240x700 h
F SR 3565 00 51	320x700 h
Load capacity: 100 kg	
Vertical drawers for shelving 705 mm depth	

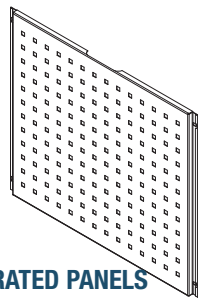

PERFORATED PANELS



ORD. NO.	DIM. mm
F SR 4210 00 01	620x500 h
For vertical drawers for 1 or 2 side storage	

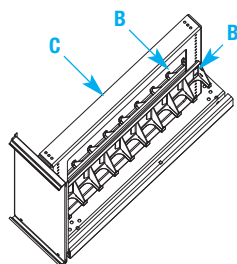
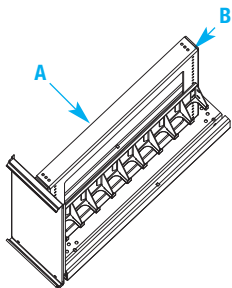
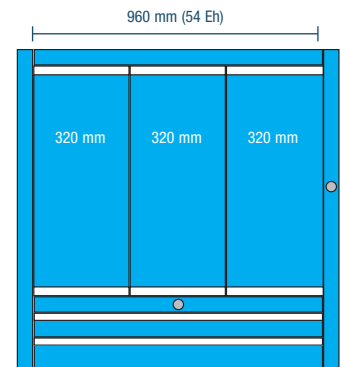
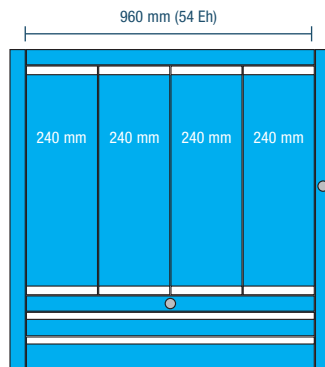

REQUIREMENTS FOR VERTICAL DRAWERS AND TOOL HANGING FRAMES

ORD. NO. DRAWERS 1 SIDE (A)	ORD. NO. TOOL HANGING FRAME (B)	FRONT WIDTH mm	FOR TOOLS	Ø MAX. mm	TOOLS Q.TY
F SR 3060 00 51	F CN 3240 00 01	240	ISO 50	112/80	5
F SR 3060 00 51	F CN 3260 00 01	240	ISO 55	130/89	4
F SR 3060 00 51	F CN 3270 00 01	240	ISO 60	160/109	3

ORD. NO. DRAWERS 2 SIDES (A)	ORD. NO. TOOL HANGING FRAME (B)	FRONT WIDTH mm	FOR TOOLS	Ø MAX. mm	TOOLS Q.TY
F SR 3560 00 51	F CN 3210 00 01	240	ISO 40	63/50	9
F SR 3560 00 51	F CN 3220 00 01	240	ISO 45	82/63	7
F SR 3560 00 51	F CN 3250 00 01	240	ISO 50	98/80	6
F SR 3565 00 51	F CN 3240 00 01	320	ISO 50	112/80	5
F SR 3565 00 51	F CN 3260 00 01	320	ISO 55	130/89	4
F SR 3565 00 51	F CN 3270 00 01	320	ISO 60	160/109	3

TOOL HANGING FRAME

ORD. NO.	FOR TOOLS	FLANGE Ø MAX. mm	SHANK Ø MAX. mm	TOOLS Q.TY	WIDTH mm	DEPTH mm
F CN 3210 00 01	ISO 40	63	50	9	597	56
F CN 3220 00 01	ISO 45	82	63	7	597	75
F CN 3230 00 01	ISO 50	98	80	5	597	84
F CN 3240 00 01	ISO 50	112	80	5	597	100
F CN 3250 00 01	ISO 50	98	80	6	623	84
F CN 3260 00 01	ISO 55	130	89	4	597	120
F CN 3270 00 01	ISO 60	160	109	3	597	140



SHELVING SYSTEM SYSTEM SR V3

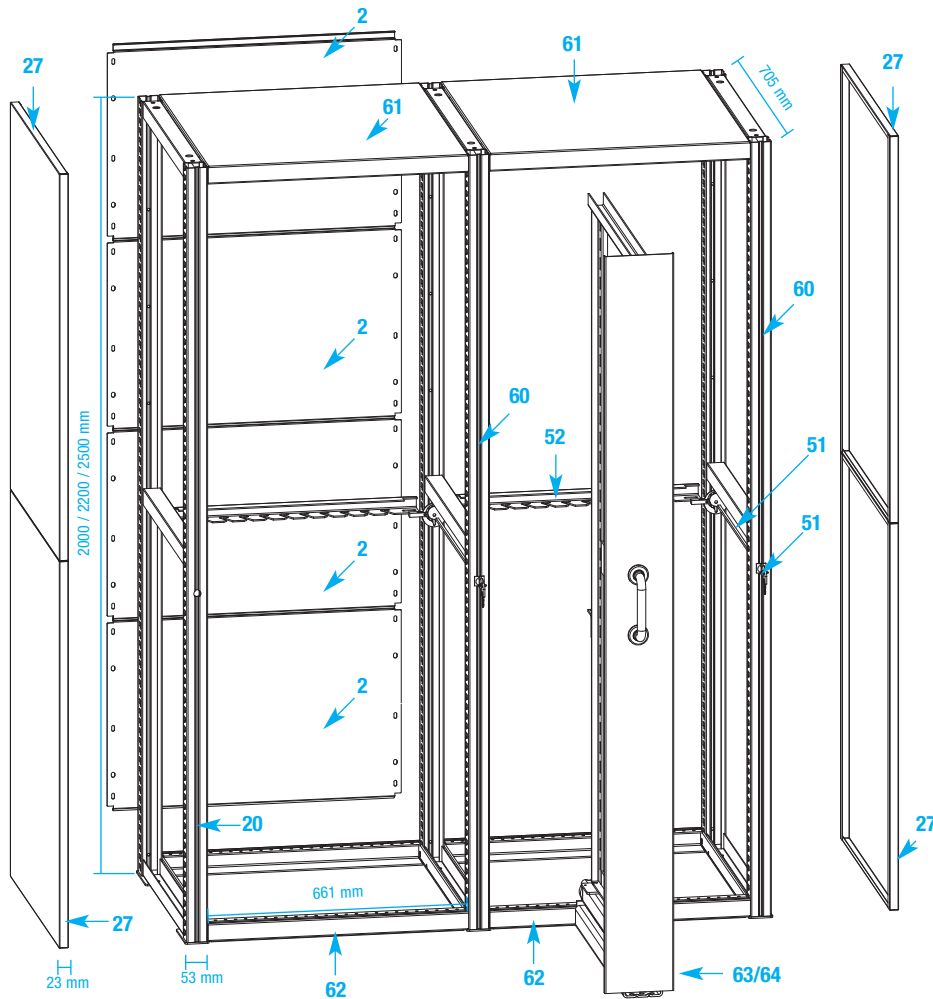

- Accessories see page F62
- Shelving must be fixed to the wall or floor
- Further information for fixing set and load capacity see page F52

51+52 LOCKING SET

01

ORD. NO.	WIDTH mm
F SR 4060 00 01	661

Including 1 lock with 2 keys, 1 square rod, 1 anti-tilt rod activation group

- Spare key (for lock ref. 51)
ORD. NO. R CSR 0003 00
- Spare key see page F64

20 UPRIGHT FRAMES

01 02 04 08

ORD. NO.	DIM. mm
F SR 0720 00 04	53x705x2000 h
F SR 0722 00 04	53x705x2200 h
F SR 0725 00 04	53x705x2500 h

27 SIDE PANELS

01 02 04 08

ORD. NO.	DIM. mm
F SR 2455 00 04	23x705x1000 h
F SR 2460 00 04	23x705x1100 h
F SR 2465 00 04	23x705x1250 h
F SR 2475 00 04	23x705x1500 h

52 ANTI-TILT ROD

01

ORD. NO.	WIDTH mm
F SR 4010 00 01	661

- It is necessary to fit an anti-tilt rod if drawers are installed

60 UPRIGHT FRAMES WITH HOLE FOR LOCK

01 02 04 08

ORD. NO.	DIM. mm
F SR 0721 00 04	53x705x2000 h
F SR 0723 00 04	53x705x2200 h
F SR 0726 00 04	53x705x2500 h

Upright frames with hole for lock for vertical drawers

2 BACK PANELS

01 02

ORD. NO.	DIM. mm
F SR 2040 00 01	2000 h
F SR 2050 00 01	2200 h
F SR 2060 00 01	2500 h

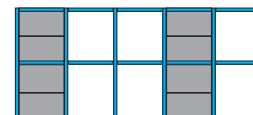

- A back panel must be fitted to each third bay

62 BOTTOM SHELVES FOR VERTICAL DRAWERS

01 02 04 08

ORD. NO.	DIM. mm
F SR 4110 00 04	661x705x46 h

61 TOP SHELVES FOR VERTICAL DRAWERS

01 02 04 08

ORD. NO.	DIM. mm
F SR 4160 00 04	661x705x46 h

Load capacity: 200 kg

WIDTH = 714 mm DEPTH = 705 mm (36x36 Eh)

SHELVING SYSTEM SYSTEM SR V3

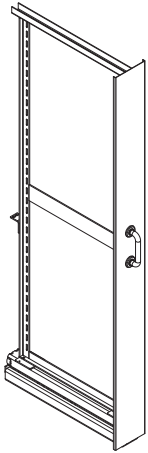

■ Accessories see page F74 - F75

63 VERTICAL DRAWERS 1 SIDE STORAGE

01 02
51 56

ORD. NO. 1715 mm h	ORD. NO. 1915 mm h	ORD. NO. 2215 mm h	FRONT WIDTH mm	USABLE WIDTH mm	LOAD CAP. KG
F SR 3110 00 51	F SR 3210 00 51	F SR 3310 00 51	100	68	400
F SR 3115 00 51	F SR 3215 00 51	F SR 3315 00 51	125	93	400
F SR 3120 00 51	F SR 3220 00 51	F SR 3320 00 51	150	118	400
F SR 3125 00 51	F SR 3225 00 51	F SR 3325 00 51	175	143	400
F SR 3130 00 51	F SR 3230 00 51	F SR 3330 00 51	200	168	400
F SR 3135 00 51	F SR 3235 00 51	F SR 3335 00 51	225	193	400
F SR 3140 00 51	F SR 3240 00 51	F SR 3340 00 51	250	212	400
Usable height mm	1715	1915	2215		
Usable depth mm	620	620	620		
Front height mm	1900	2100	2400		
For shelving height mm	2000	2200	2500		

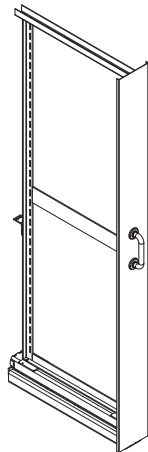

■ Accessories see page F74 - F75

64 VERTICAL DRAWERS 2 SIDES STORAGE

01 02
51 56

ORD. NO. 1715 mm h	ORD. NO. 1915 mm h	ORD. NO. 2215 mm h	FRONT WIDTH mm	USABLE WIDTH mm	LOAD CAP. KG
F SR 3610 00 51	F SR 3710 00 51	F SR 3810 00 51	150	68+68	400
F SR 3615 00 51	F SR 3715 00 51	F SR 3815 00 51	175	68+93	400
F SR 3620 00 51	F SR 3720 00 51	F SR 3820 00 51	200	93+93	400
F SR 3625 00 51	F SR 3725 00 51	F SR 3825 00 51	200	68+118	400
F SR 3630 00 51	F SR 3730 00 51	F SR 3830 00 51	225	93+118	400
F SR 3635 00 51	F SR 3735 00 51	F SR 3835 00 51	225	68+143	400
F SR 3640 00 51	F SR 3740 00 51	F SR 3840 00 51	250	118+118	400
F SR 3645 00 51	F SR 3745 00 51	F SR 3845 00 51	250	93+143	400
F SR 3650 00 51	F SR 3750 00 51	F SR 3850 00 51	250	68+168	400
Usable height mm	1715	1915	2215		
Usable depth mm	620	620	620		
Front height mm	1900	2100	2400		
For shelving height mm	2000	2200	2500		

EXAMPLE OF VERTICAL DRAWERS

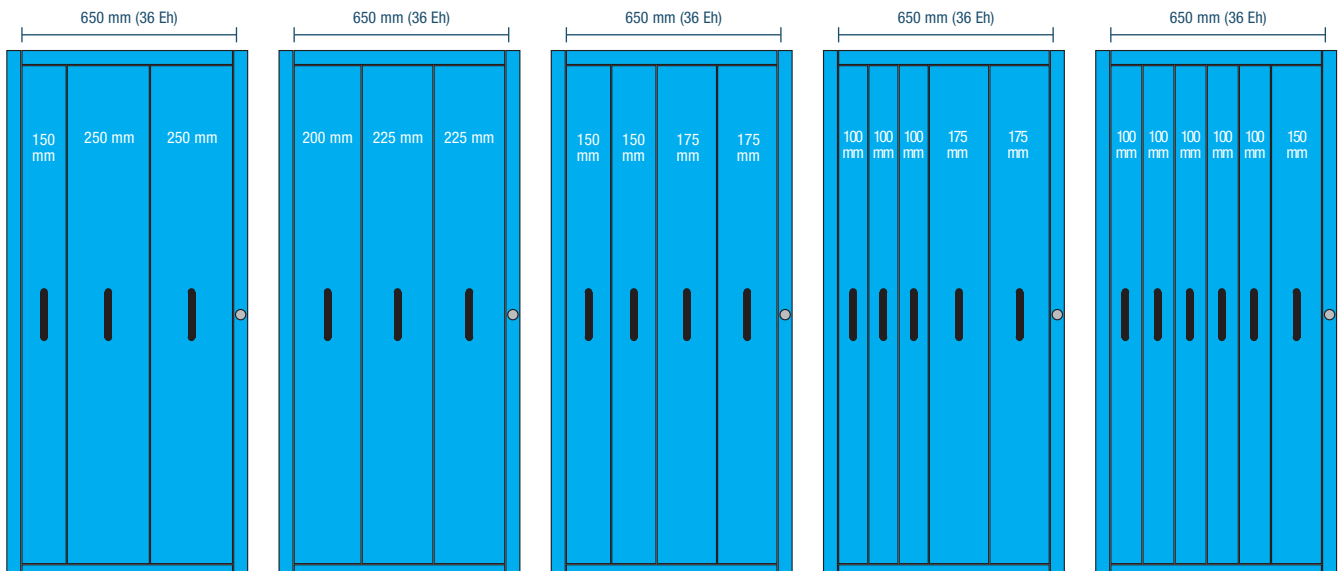

SHELVING SYSTEM SYSTEM SR V4

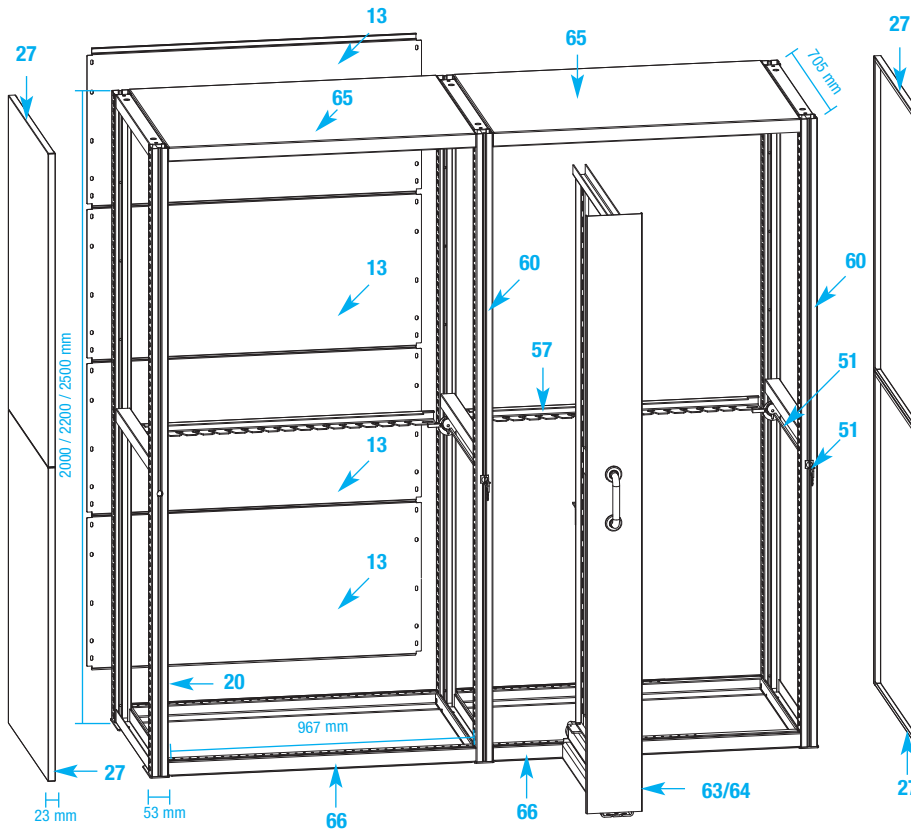

- Accessories see page F62
- Shelving must be fixed to the wall or floor
- Further information for fixing set and load capacity see page F56

51+57 LOCKING SET

■ 01

ORD. NO. WIDTH mm

F SR 4070 00 01 967

Including 1 lock with 2 keys, 1 square rod, 1 anti-tilt rod activation group

- Spare key (for lock ref. 51)
ORD. NO. R CSR 0003 00
- Spare key see page F64

20 UPRIGHT FRAMES

■ 01 ■ 02 ■ 04 ■ 08

ORD. NO. DIM. mm

F SR 0720 00 04 53x705x2000 h

F SR 0722 00 04 53x705x2200 h

F SR 0725 00 04 53x705x2500 h

27 SIDE PANELS

■ 01 ■ 02 ■ 04 ■ 08

ORD. NO. DIM. mm

F SR 2455 00 04 23x705x1000 h

F SR 2460 00 04 23x705x1100 h

F SR 2465 00 04 23x705x1250 h

F SR 2475 00 04 23x705x1500 h

57 ANTI-TILT ROD

■ 01

ORD. NO. WIDTH mm

F SR 4020 00 01 967

- It is necessary to fit an anti-tilt rod if drawers are installed

60 UPRIGHT FRAMES WITH HOLE FOR LOCK

■ 01 ■ 02 ■ 04 ■ 08

ORD. NO. DIM. mm

F SR 0721 00 04 53x705x2000 h

F SR 0723 00 04 53x705x2200 h

F SR 0726 00 04 53x705x2500 h

Upright frames with hole for lock for vertical drawers

13 BACK PANELS

■ 01 ■ 02

ORD. NO. DIM. mm

F SR 2140 00 01 2000 h

F SR 2150 00 01 2200 h

F SR 2160 00 01 2500 h

66 BOTTOM SHELVES FOR VERTICAL DRAWERS

■ 01 ■ 02 ■ 04 ■ 08

ORD. NO. DIM. mm

F SR 4120 00 04 967x705x46 h

65 TOP SHELVES FOR VERTICAL DRAWERS

■ 01 ■ 02 ■ 04 ■ 08

ORD. NO. DIM. mm

F SR 4170 00 04 967x705x46 h

Load capacity: 200 kg

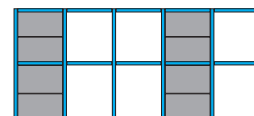

■ A back panel must be fitted to each third bay

WIDTH = 1020 mm DEPTH = 705 mm (54x36 Eh)

SHELVING SYSTEM SYSTEM SR V4

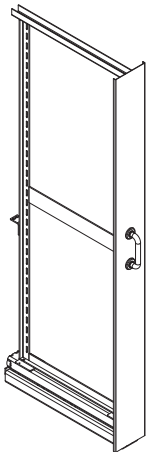

■ Accessories see page F74 - F75

63 VERTICAL DRAWERS 1 SIDE STORAGE

01 02
51 56

ORD. NO. 1715 mm h	ORD. NO. 1915 mm h	ORD. NO. 2215 mm h	FRONT WIDTH mm	USABLE WIDTH mm	LOAD CAP. KG
F SR 3110 00 51	F SR 3210 00 51	F SR 3310 00 51	100	68	400
F SR 3115 00 51	F SR 3215 00 51	F SR 3315 00 51	125	93	400
F SR 3120 00 51	F SR 3220 00 51	F SR 3320 00 51	150	118	400
F SR 3125 00 51	F SR 3225 00 51	F SR 3325 00 51	175	143	400
F SR 3130 00 51	F SR 3230 00 51	F SR 3330 00 51	200	168	400
F SR 3135 00 51	F SR 3235 00 51	F SR 3335 00 51	225	193	400
F SR 3140 00 51	F SR 3240 00 51	F SR 3340 00 51	250	212	400
Usable height mm	1715	1915	2215		
Usable depth mm	620	620	620		
Front height mm	1900	2100	2400		
For shelving height mm	2000	2200	2500		

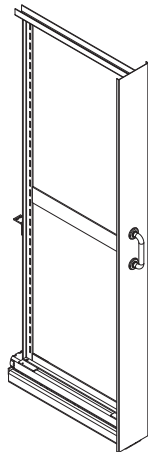

■ Accessories see page F74 - F75

64 VERTICAL DRAWERS 2 SIDES STORAGE

01 02
51 56

ORD. NO. 1715 mm h	ORD. NO. 1915 mm h	ORD. NO. 2215 mm h	FRONT WIDTH mm	USABLE WIDTH mm	LOAD CAP. KG
F SR 3610 00 51	F SR 3710 00 51	F SR 3810 00 51	150	68+68	400
F SR 3615 00 51	F SR 3715 00 51	F SR 3815 00 51	175	68+93	400
F SR 3620 00 51	F SR 3720 00 51	F SR 3820 00 51	200	93+93	400
F SR 3625 00 51	F SR 3725 00 51	F SR 3825 00 51	200	68+118	400
F SR 3630 00 51	F SR 3730 00 51	F SR 3830 00 51	225	93+118	400
F SR 3635 00 51	F SR 3735 00 51	F SR 3835 00 51	225	68+143	400
F SR 3640 00 51	F SR 3740 00 51	F SR 3840 00 51	250	118+118	400
F SR 3645 00 51	F SR 3745 00 51	F SR 3845 00 51	250	93+143	400
F SR 3650 00 51	F SR 3750 00 51	F SR 3850 00 51	250	68+168	400
Usable height mm	1715	1915	2215		
Usable depth mm	620	620	620		
Front height mm	1900	2100	2400		
For shelving height mm	2000	2200	2500		

EXAMPLE OF VERTICAL DRAWERS

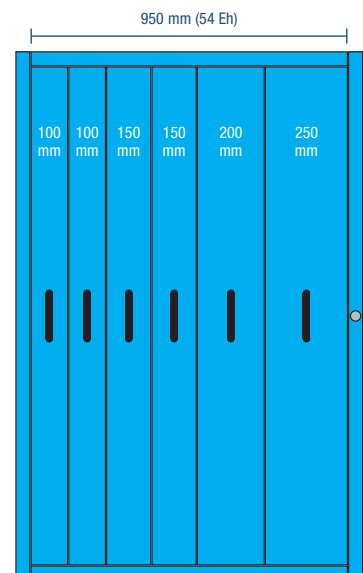
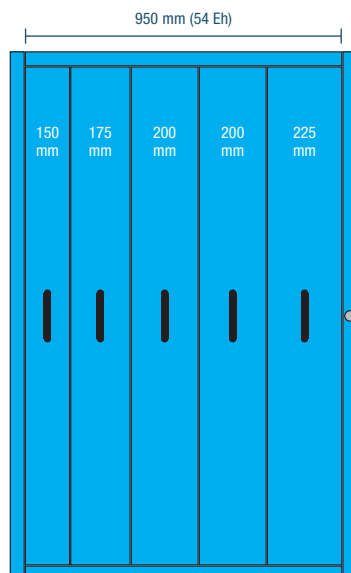
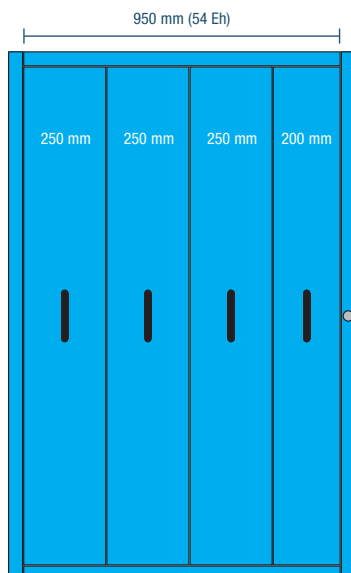

SHELVING SYSTEM SYSTEM SR V34

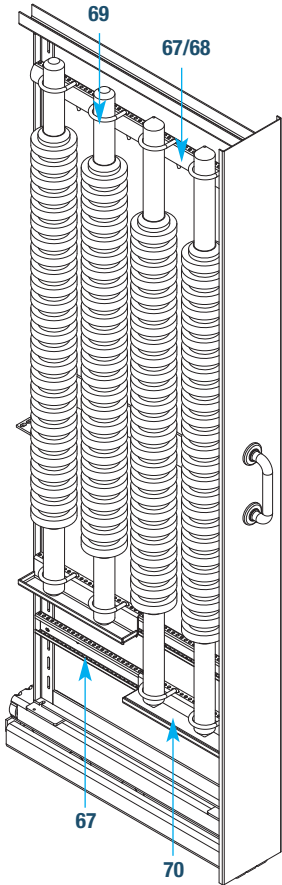

70 BOTTOM SHELVES WITH WOODEN INSERT

ORD. NO.	DIM. mm
F SR 4260 01 01	310x50
F SR 4265 01 01	310x75
F SR 4270 01 01	310x100
F SR 4275 01 01	310x125
F SR 4280 01 01	310x150

■ Load capacity 150 kg

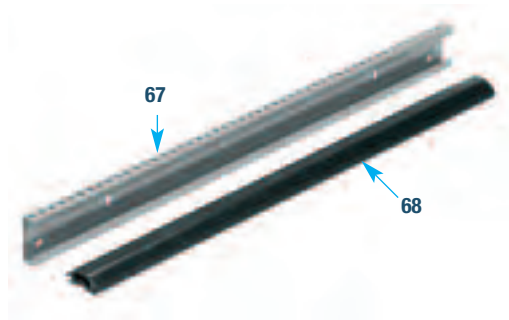

67 TRAVERSE HOLDERS

■ 01 ■ 02

ORD. NO.	DIM. mm
F CN 3010 00 01	623x28x50 h

68 NEOPRENE PROFILE

■ 07

ORD. NO.	DIM. mm
F CN 3030 00 07	-

**VERTICAL DRAWER
2 SIDES STORAGE**

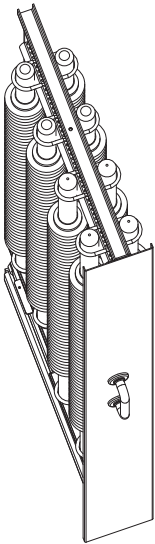

**VERTICAL DRAWER
1 SIDE STORAGE**

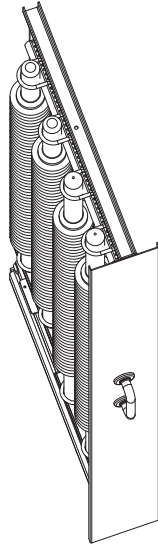

**VERTICAL DRAWER
2 SIDES STORAGE**

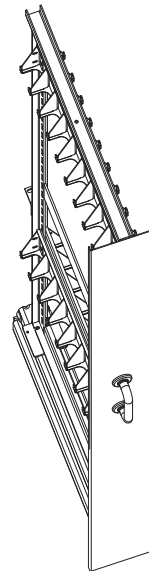

**VERTICAL DRAWER
1 SIDE STORAGE**

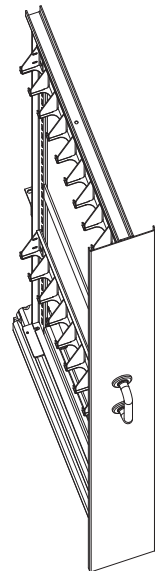

TOOL HANGING FRAME

ORD. NO.	FOR TOOLS	FLANGE Ø MAX. mm	SHANK Ø MAX. mm	TOOL Q.TY	WIDTH mm	DEPTH mm	FOR VERTICAL DRAWER WITH USABLE WIDTH mm
F CN 3210 00 01	ISO 40	63	50	9	597	56	68
F CN 3220 00 01	ISO 45	82	63	7	597	75	93
F CN 3230 00 01	ISO 50	98	80	5	597	84	118
F CN 3240 00 01	ISO 50	112	80	5	597	100	118
F CN 3250 00 01	ISO 50	98	80	6	623	84	118
F CN 3260 00 01	ISO 55	130	89	4	597	120	143
F CN 3270 00 01	ISO 60	160	109	3	597	140	168

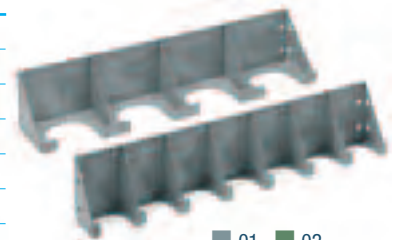

■ 01 ■ 02

69 TOOL RETENTION HOLDERS

ORD. NO.	FOR TOOL Ø MAX. mm	MAX Q.TY RETENTION HOLDERS	UNITS Q.TY PER RETENTION HOLDERS
F CN 3105 00 99	15	16	2
F CN 3110 00 99	27	12	3
F CN 3115 00 99	35	9	4
F CN 3120 00 99	48	8	5
F CN 3125 00 99	60	6	6
F CN 3130 00 99	73	6	7
F CN 3135 00 99	85	5	8
F CN 3140 00 99	98	4	9
F CN 3145 00 99	110	4	10
F CN 3150 00 99	123	4	11
F CN 3155 00 99	135	3	12

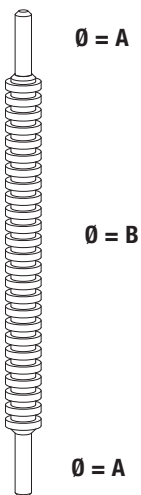
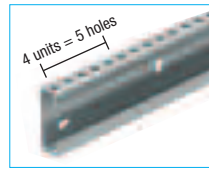

REQUIREMENTS FOR RETENTION HOLDERS

ORD. NO.	DRAWERS FRONT WIDTH	TOOL Ø mm (A)	TOOL Ø mm (B)
F CN 3115 00 99	100	35	55
F CN 3110 00 99	100	27	68
F CN 3125 00 99	125	60	80
F CN 3120 00 99	125	48	93
F CN 3135 00 99	150	85	105
F CN 3130 00 99	150	73	118
F CN 3145 00 99	175	110	130
F CN 3140 00 99	175	98	143
F CN 3155 00 99	200	135	155

PERFORATED PANELS

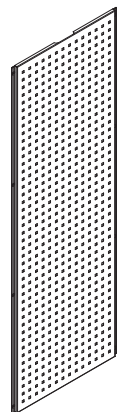

■ 01 ■ 02

ORD. NO.	DIM. mm
F SR 4210 00 01	620x500 h
F SR 4215 00 01	620x1715 h
F SR 4220 00 01	620x1915 h
F SR 4225 00 01	620x2215 h

ORD. NO.	VERT. DRAWERS 2 SIDES STORAGE - LEFT HAND	DRAWERS FRONT WIDTH	TOOL Ø mm (A)	TOOL Ø mm (B)
F CN 3115 00 99	150	150	35	55
F CN 3115 00 99	150	150	35	55
F CN 3110 00 99	150	150	27	68
F CN 3115 00 99	175	175	35	55
F CN 3115 00 99	175	175	35	55
F CN 3110 00 99	175	175	27	68
F CN 3110 00 99	175	175	27	68
F CN 3125 00 99	200	200	60	80
F CN 3125 00 99	200	200	60	80
F CN 3120 00 99	200	200	48	93
F CN 3125 00 99	225	225	60	80
F CN 3125 00 99	225	225	60	80
F CN 3120 00 99	225	225	48	93
F CN 3120 00 99	225	225	48	93
F CN 3135 00 99	250	250	85	105
F CN 3135 00 99	250	250	85	105
F CN 3130 00 99	250	250	73	118

ORD. NO.	VERT. DRAWERS 2 SIDES STORAGE - RIGHT HAND	DRAWERS FRONT WIDTH	TOOL Ø mm (A)	TOOL Ø mm (B)
F CN 3115 00 99	150	150	35	55
F CN 3110 00 99	150	150	27	68
F CN 3110 00 99	150	150	27	68
F CN 3125 00 99	175	175	60	80
F CN 3120 00 99	175	175	48	93
F CN 3125 00 99	175	175	60	80
F CN 3120 00 99	175	175	48	93
F CN 3125 00 99	200	200	60	80
F CN 3120 00 99	200	200	48	93
F CN 3120 00 99	200	200	48	93
F CN 3135 00 99	225	225	85	105
F CN 3130 00 99	225	225	73	118
F CN 3135 00 99	225	225	85	105
F CN 3135 00 99	250	250	85	105
F CN 3130 00 99	250	250	73	118
F CN 3130 00 99	250	250	73	118

A close-up photograph of a hand holding a blue storage container. The background is dark, and the lighting highlights the texture of the hand and the metallic-looking surface of the container. The text 'G SPACE' is overlaid on the left side of the image.

G SPACE

RETHINKING

- **STACKING AND STORAGE CONTAINERS SERIES STORAGE**

FOR ALL USES

UP TO 5 COLOURS AVAILABLE

STRONG AND RELIABLE THROUGH TIME

SUITABLE FOR CARRIAGE AND STORAGE

ON REQUEST CAN BE SUPPLIED SUITABLE TO STORE FOODSTUFFS

A close-up photograph of a person's hand holding a blue, rectangular storage case. The case is open, revealing a dark interior with a textured surface. The hand is positioned at the top and right edges of the case. The background is solid black, which makes the blue case and the hand stand out. The lighting is dramatic, highlighting the contours of the hand and the texture of the case.

G SPACE

RETHINKING

SERIES STORAGE ATHENA

- FOR AUTOMATIC STORAGE SYSTEMS
- FOR AUTOMATIC HANDLING
- FOR MANUAL HANDLING
- SHOCK RESISTANT
- OIL RESISTANT



Resistant to high and low temperatures



Oil resistant



The stacking containers marked with this symbol can be used to store foodstuffs



ABS COVERS FOR ATHENA STACKING CONTAINERS



■ 07

ORD. NO.

DIM. mm

F VW 0006 00 07

1200x1000x70

Standard colour ■



Example of use of the cover and of the pallet



■ 07

ORD. NO.

DIM. mm

F VW 0007 00 07

1200x800x70

Standard colour ■

GREY
F. 01

BLACK
F. 07

KEY ■

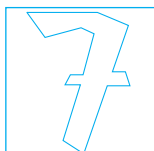

The stacking containers marked with this symbol can be used to store foodstuffs.



Containers with this symbol are made of completely recyclable plastic material.



DIMENSIONS = 300x200 mm

SERIES STORAGE ATHENA

PLASTIC PALLETS

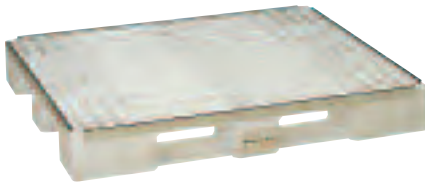

ORD. NO. EXTERNAL DIM. mm

F PU 2240 00 13	1200x800x150 h
Load capacity on floor kg	4000
Load capacity on fork lift truck kg	1500
Weight kg	13,70

ORD. NO. EXTERNAL DIM. mm

F PU 3240 00 13	1200x1000x150 h
Load capacity on floor kg	4000
Load capacity on fork lift truck kg	1500
Weight kg	16,70

Plastic pallets for **Athena** and **Thema** containers with galvanised steel edges on all 4 sides

01



ORD. NO. DIM. mm

F PA 2451 A0 01	300x200x120 h
External dim. mm	300x200x120 h
Internal dim. mm	260x160x100 h
Capacity litres	5
Weight gr.	450
Standard colour*	■
Bottom	solid
Long sides	closed
Short sides	closed
Lifting	bars

Label holder: ORD. NO. **F PZ 0010 00 99**
See page G15

■ *On request other colours available

01



ORD. NO. DIM. mm

F PA 2851 A0 01	300x200x170 h
External dim. mm	300x200x170 h
Internal dim. mm	258x160x154 h
Capacity litres	7
Weight gr.	670
Standard colour*	■
Bottom	solid
Long sides	closed
Short sides	closed
Lifting	bars

Label holder: ORD. NO. **F PZ 0010 00 99**
See page G15

■ *On request other colours available

TROLLEY WITH STACKING CONTAINERS

ORD. NO. DIM. mm

F LB B103 53 52	1023x613x1430 h
------------------------	------------------------

- Including:
- 1 trolley ORD. NO. F LB B103 03 52
 - 2 standard rubber swivel wheels with brakes Ø 125 mm
 - 2 standard rubber fixed wheels Ø 125 mm
 - 3 shelves depth 420 mm
 - 5 stacking containers ORD. NO. F PA 4451 A0 01
 - 2 stacking containers ORD. NO. F PA 6451 A0 01
 - 2 stacking containers ORD. NO. F PA 6851 A0 01
 - Load capacity 300 kg (150 kg per side)

■ For any further information: see page D2



ORD. NO. F LB B103 53 52

KEY



The stacking containers marked with this symbol can be used to store foodstuffs.



Containers with this symbol are made of completely recyclable plastic material.



GREY
F.....01

SERIES STORAGE ATHENA

■ 01

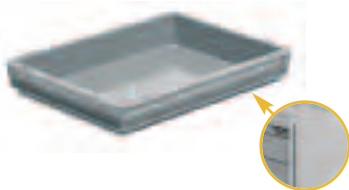
**ORD. NO.**

DIM. mm

F PA 3251 AO 01 400x300x55 h

External dim. mm 400x300x55 h

Internal dim. mm 355x254x37 h

Capacity litres 3,8

Weight gr. 505

Standard colour* ■

Bottom **solid**Long sides **closed**Short sides **closed**Lifting **bars**Label holder: ORD. NO. **F PZ 0010 00 99**

See page G15

■ 01

**ORD. NO.**

DIM. mm

F PA 3651 AO 01 400x300x78 h

External dim. mm 400x300x78 h

Internal dim. mm 355x255x59 h

Capacity litres 6

Weight gr. 550

Standard colour* ■

Bottom **solid**Long sides **closed**Short sides **closed**Lifting **bars**Label holder: ORD. NO. **F PZ 0010 00 99**

See pag. G15

■ 01

**ORD. NO.**

DIM. mm

F PA 4051 AO 01 400x300x120 h

External dim. mm 400x300x120 h

Internal dim. mm 357x257x102 h

Capacity litres 10

Weight gr. 770

Standard colour* ■

Bottom **solid**Long sides **closed**Short sides **closed**Lifting **bars**Label holder: ORD. NO. **F PZ 0010 00 99**

See pag. G15

■ 01

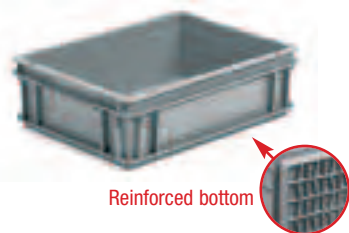
**ORD. NO.**

DIM. mm

F PA 4151 AO 01 400x300x125 h

External dim. mm 400x300x125 h

Internal dim. mm 357x256x94 h

Capacity litres 10

Weight gr. 1005

Standard colour* ■

Bottom **reinforced**Long sides **closed**Short sides **closed**Lifting **bars**Label holder: ORD. NO. **F PZ 0010 00 99**

See page G15

■ 01

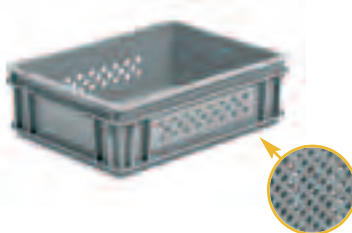
**ORD. NO.**

DIM. mm

F PA 4051 EO 01 400x300x120 h

External dim. mm 400x300x120 h

Internal dim. mm 357x256x99 h

Capacity litres 10

Weight gr. 820

Standard colour* ■

Bottom **perforated**Long sides **perforated**Short sides **closed**Lifting **bars**Label holder: ORD. NO. **F PZ 0010 00 99**

See page G15

■ 01

**ORD. NO.**

DIM. mm

F PA 4451 AO 01 400x300x170 h

External dim. mm 400x300x170 h

Internal dim. mm 357x257x152 h

Capacity litres 15

Weight gr. 1070

Standard colour* ■

Bottom **solid**Long sides **closed**Short sides **closed**Lifting **bars**Label holder: ORD. NO. **F PZ 0010 00 99**,ORD. NO. **F PZ 9551 00 07**. See page G15

■ *On request other colours available

GREY
F.....01**KEY ■**

The stacking containers marked with this symbol can be used to store foodstuffs.



Containers with this symbol are made of completely recyclable plastic material.



DIMENSIONS = 400x300 mm

SERIES STORAGE ATHENA

01



Reinforced bottom



ORD. NO. DIM. mm

F PA 4551 AO 01 400x300x178 h

External dim. mm 400x300x178 h

Internal dim. mm 357x255x145 h

Capacity litres 15

Weight gr. 1485

Standard colour* ■

Bottom **reinforced**

Long sides **closed**

Short sides **closed**

Lifting **bars**

Label holder: ORD. NO. **F PZ 0010 00 99**,
ORD. NO. **F PZ 9551 00 07**. See pag. G15

01



ORD. NO. DIM. mm

F PA 4851 AO 01 400x300x220 h

External dim. mm 400x300x220 h

Internal dim. mm 357x258x207 h

Capacity litres 20

Weight gr. 1230

Standard colour* ■

Bottom **solid**

Long sides **closed**

Short sides **closed**

Lifting **bars**

Label holder: ORD. NO. **F PZ 0010 00 99**,
ORD. NO. **F PZ 9551 00 07**. See pag. G15

01



ORD. NO. DIM. mm

F PA 4851 BO 01 400x300x220 h

External dim. mm 400x300x220 h

Internal dim. mm 357x258x206 h

Capacity litres 20

Weight gr. 1200

Standard colour* ■

Bottom **solid**

Long sides **closed**

Short sides **closed**

Lifting **holes**

Label holder: ORD. NO. **F PZ 0010 00 99**,
ORD. NO. **F PZ 9551 00 07**. See pag. G15

01



Reinforced bottom



ORD. NO. DIM. mm

F PA 4951 BO 01 400x300x230 h

External dim. mm 400x300x230 h

Internal dim. mm 356x257x197 h

Capacity litres 20

Weight gr. 1390

Standard colour* ■

Bottom **reinforced**

Long sides **closed**

Short sides **closed**

Lifting **holes**

Label holder: ORD. NO. **F PZ 0010 00 99**,
ORD. NO. **F PZ 9551 00 07**. See pag. G15

01



ORD. NO. DIM. mm

F PA 5251 AO 01 400x300x325 h

External dim. mm 400x300x325 h

Internal dim. mm 356x255x307 h

Capacity litres 30

Weight gr. 2050

Standard colour* ■

Bottom **solid**

Long sides **closed**

Short sides **closed**

Lifting **bars**

Label holder: ORD. NO. **F PZ 0010 00 99**,
ORD. NO. **F PZ 9551 00 07**. See pag. G15

01



ORD. NO. DIM. mm

F PA 5251 BO 01 400x300x325 h

External dim. mm 400x300x325 h

Internal dim. mm 355x255x305 h

Capacity litres 30

Weight gr. 2020

Standard colour* ■

Bottom **solid**

Long sides **closed**

Short sides **closed**

Lifting **holes**

Label holder: ORD. NO. **F PZ 0010 00 99**,
ORD. NO. **F PZ 9551 00 07**. See pag. G15

*On request other colours available

Athena series stacking containers
ORD. NO. **F PA 6851 BO 01**



KEY



The stacking containers marked with this symbol can be used to store foodstuffs.



Containers with this symbol are made of completely recyclable plastic material.

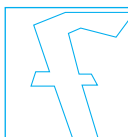

GREY
F.....01

SERIES STORAGE ATHENA

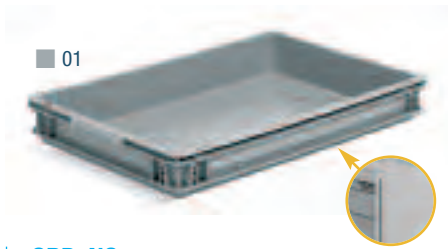

■ 01

ORD. NO. DIM. mm

F PA 5651 AO 01 600x400x76 h

External dim. mm 600x400x76 h

Internal dim. mm 555x353x58 h

Capacity litres 10

Weight gr. 1242

Standard colour* ■

Bottom **solid**Long sides **closed**Short sides **closed**Lifting **bars**Label holder: ORD. NO. **F PZ 0010 00 99**

See page G15

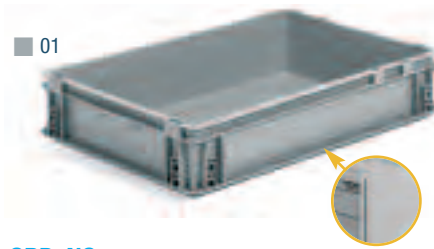

■ 01

ORD. NO. DIM. mm

F PA 6051 AO 01 600x400x120 h

External dim. mm 600x400x120 h

Internal dim. mm 557x357x102 h

Capacity litres 20

Weight gr. 1585

Standard colour* ■

Bottom **solid**Long sides **closed**Short sides **closed**Lifting **bars**Label holder: ORD. NO. **F PZ 0010 00 99**

See page G15

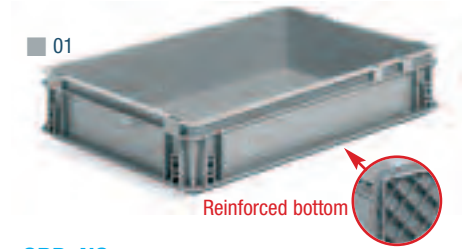

■ 01

ORD. NO. DIM. mm

F PA 6151 AO 01 600x400x120 h

External dim. mm 600x400x120 h

Internal dim. mm 555x354x97 h

Capacity litres 20

Weight gr. 1685

Standard colour* ■

Bottom **reinforced**Long sides **closed**Short sides **closed**Lifting **bars**Label holder: ORD. NO. **F PZ 0010 00 99**

See page G15

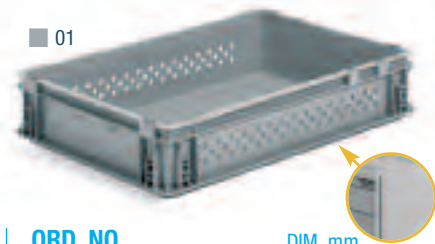

■ 01

ORD. NO. DIM. mm

F PA 6051 CO 01 600x400x120 h

External dim. mm 600x400x120 h

Internal dim. mm 557x356x102 h

Capacity litres 20

Weight gr. 1575

Standard colour* ■

Bottom **solid**Long sides **perforated**Short sides **closed**Lifting **bars**Label holder: ORD. NO. **F PZ 0010 00 99**

See page G15



■ 01

ORD. NO. DIM. mm

F PA 6051 EO 01 600x400x120 h

External dim. mm 600x400x120 h

Internal dim. mm 557x357x103 h

Capacity litres 20

Weight gr. 1500

Standard colour* ■

Bottom **perforated**Long sides **perforated**Short sides **closed**Lifting **bars**Label holder: ORD. NO. **F PZ 0010 00 99**

See page G15



TROLLEY

ORD. NO. DIM. mm

F CP 2011 02 99 615x415x170/870 hTrolley with 4 standard rubber swivel wheels
without brakes Ø 100 mm

Load capacity 150 kg

without stacking containers

■ For any further information: see page E8

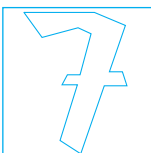
GREY
F.....01

KEY ■



The stacking containers marked with this symbol can be used to store foodstuffs.



Containers with this symbol are made of completely recyclable plastic material.



DIMENSIONS = 600x400 mm

SERIES STORAGE ATHENA



ORD. NO.	DIM. mm
F PA 6451 AO 01	600x400x170 h
External dim. mm	600x400x170 h
Internal dim. mm	560x358x153 h
Capacity litres	30
Weight gr.	2125
Standard colour*	■
Bottom	solid
Long sides	closed
Short sides	closed
Lifting	bars
Label holder: ORD. NO. F PZ 0010 00 99 , ORD. NO. F PZ 9751 00 07 . See page G15	

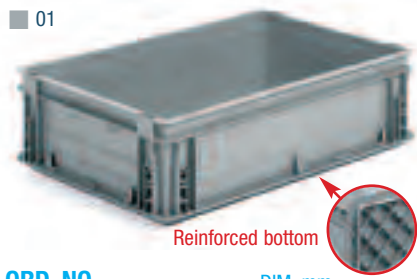

ORD. NO.	DIM. mm
F PA 6551 AO 01	600x400x170 h
External dim. mm	600x400x170 h
Internal dim. mm	558x358x139 h
Capacity litres	30
Weight gr.	2330
Standard colour*	■
Bottom	reinforced
Long sides	closed
Short sides	closed
Lifting	bars
Label holder: ORD. NO. F PZ 0010 00 99 , ORD. NO. F PZ 9751 00 07 . See page G15	



ORD. NO.	DIM. mm
F PA 6851 AO 01	600x400x220 h
External dim. mm	600x400x220 h
Internal dim. mm	558x356x202 h
Capacity litres	40
Weight gr.	2620
Standard colour*	■
Bottom	solid
Long sides	closed
Short sides	closed
Lifting	holes
Label holder: ORD. NO. F PZ 0010 00 99 , ORD. NO. F PZ 9751 00 07 . See page G15	



ORD. NO.	DIM. mm
F PA 6851 BO 01	600x400x220 h
External dim. mm	600x400x220 h
Internal dim. mm	558x357x202 h
Capacity litres	40
Weight gr.	2570
Standard colour*	■
Bottom	solid
Long sides	closed
Short sides	closed
Lifting	holes
Label holder: ORD. NO. F PZ 0010 00 99 , ORD. NO. F PZ 9751 00 07 . See page G15	

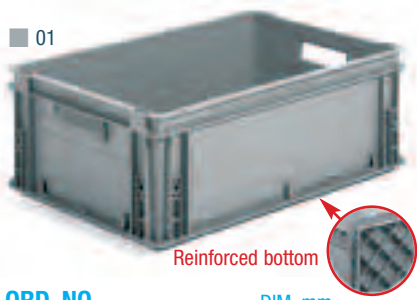

ORD. NO.	DIM. mm
F PA 6951 BO 01	600x400x220 h
External dim. mm	600x400x220 h
Internal dim. mm	560x358x188 h
Capacity litres	40
Weight gr.	2875
Standard colour*	■
Bottom	reinforced
Long sides	closed
Short sides	closed
Lifting	holes
Label holder: ORD. NO. F PZ 0010 00 99 , ORD. NO. F PZ 9751 00 07 . See page G15	

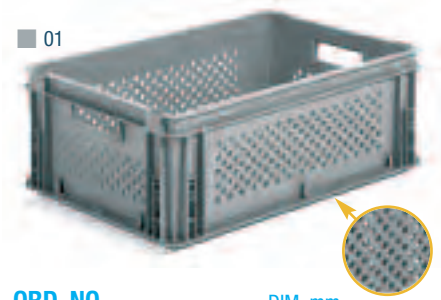

ORD. NO.	DIM. mm
F PA 6851 FO 01	600x400x220 h
External dim. mm	600x400x220 h
Internal dim. mm	557x356x202 h
Capacity litres	40
Weight gr.	2480
Standard colour*	■
Bottom	perforated
Long sides	perforated
Short sides	perforated
Lifting	holes
Label holder: ORD. NO. F PZ 0010 00 99 , ORD. NO. F PZ 9751 00 07 . See page G15	

*On request other colours available

TROLLEY

ORD. NO.
F CR 0441 00 04
Trolley with 2 polyurethane swivel wheels in rubber Ø 125 mm, 2 fixed wheels Ø 125 mm
Load capacity 300 kg
Only for lifting Athena and Odette series 600x400 mm

For any further information: see page G15



KEY



The stacking containers marked with this symbol can be used to store foodstuffs.



Containers with this symbol are made of completely recyclable plastic material.



GREY
F.....01

SERIES STORAGE ATHENA



ORD. NO.	DIM. mm
F PA 7251 AO 01	600x400x285 h
External dim. mm	600x400x285 h
Internal dim. mm	557x356x263 h
Capacity litres	53
Weight gr.	2765
Standard colour*	■
Bottom	solid
Long sides	closed
Short sides	closed
Lifting	bars
Label holder: ORD. NO. F PZ 0010 00 99 , ORD. NO. F PZ 9751 00 07 . See page G15	

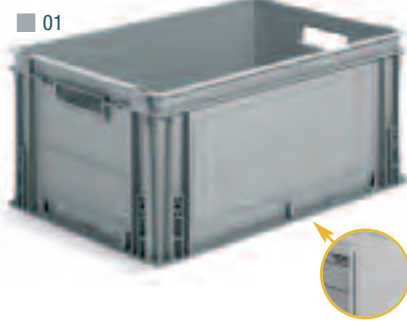

ORD. NO.	DIM. mm
F PA 7251 BO 01	600x400x285 h
External dim. mm	600x400x285 h
Internal dim. mm	557x357x263 h
Capacity litres	53
Weight gr.	2895
Standard colour*	■
Bottom	solid
Long sides	closed
Short sides	closed
Lifting	holes
Label holder: ORD. NO. F PZ 0010 00 99 , ORD. NO. F PZ 9751 00 07 . See page G15	

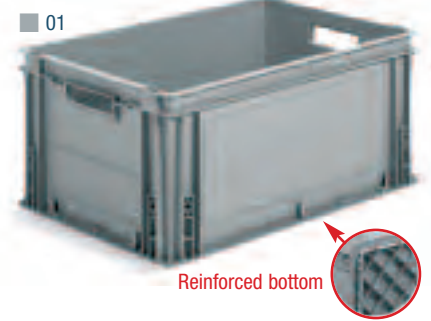

ORD. NO.	DIM. mm
F PA 7351 BO 01	600x400x285 h
External dim. mm	600x400x285 h
Internal dim. mm	557x357x256 h
Capacity litres	53
Weight gr.	3120
Standard colour*	■
Bottom	reinforced
Long sides	closed
Short sides	closed
Lifting	holes
Label holder: ORD. NO. F PZ 0010 00 99 , ORD. NO. F PZ 9751 00 07 . See page G15	



ORD. NO.	DIM. mm
F PA 7651 AO 01	600x400x325 h
External dim. mm	600x400x325 h
Internal dim. mm	558x358x308 h
Capacity litres	60
Weight gr.	3315
Standard colour*	■
Bottom	solid
Long sides	closed
Short sides	closed
Lifting	bars
Label holder: ORD. NO. F PZ 0010 00 99 , ORD. NO. F PZ 9751 00 07 . See page G15	



ORD. NO.	DIM. mm
F PA 7651 BO 01	600x400x325 h
External dim. mm	600x400x325 h
Internal dim. mm	558x357x308 h
Capacity litres	60
Weight gr.	3215
Standard colour*	■
Bottom	solid
Long sides	closed
Short sides	closed
Lifting	holes
Label holder: ORD. NO. F PZ 0010 00 99 , ORD. NO. F PZ 9751 00 07 . See page G15	

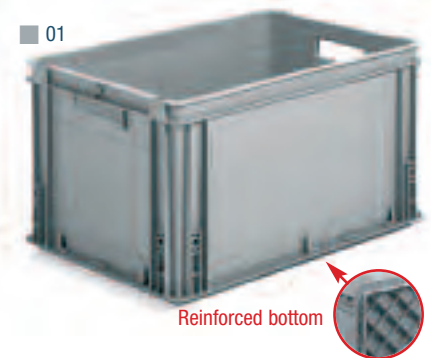

ORD. NO.	DIM. mm
F PA 7751 BO 01	600x400x325 h
External dim. mm	600x400x325 h
Internal dim. mm	558x358x295 h
Capacity litres	60
Weight gr.	3630
Standard colour*	■
Bottom	reinforced
Long sides	closed
Short sides	closed
Lifting	holes
Label holder: ORD. NO. F PZ 0010 00 99 , ORD. NO. F PZ 9751 00 07 . See page G15	

■ *On request other colours available

GREY
F.....01

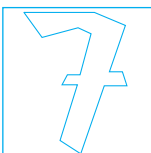

KEY ■



The stacking containers marked with this symbol can be used to store foodstuffs.



Containers with this symbol are made of completely recyclable plastic material.



DIMENSIONS = 600x400 mm

SERIES STORAGE ATHENA

■ 01

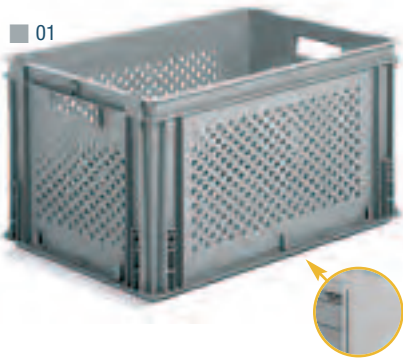

ORD. NO.	DIM. mm
F PA 7651 DO 01	600x400x325 h
External dim. mm	600x400x325 h
Internal dim. mm	558x358x308 h
Capacity litres	60
Weight gr.	3040
Standard colour*	■
Bottom	solid
Long sides	perforated
Short sides	perforated
Lifting	holes
Label holder: ORD. NO. F PZ 0010 00 99 , ORD. NO. F PZ 9751 00 07 . See page G15	

■ 01

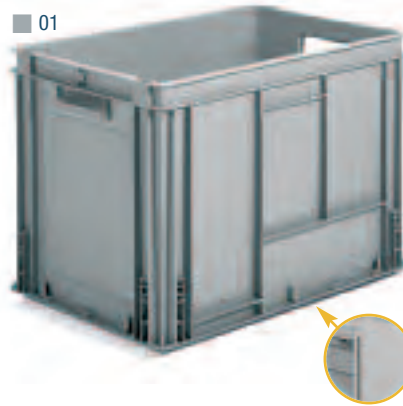

ORD. NO.	DIM. mm
F PA 8051 BO 01	600x400x430 h
External dim. mm	600x400x430 h
Internal dim. mm	557x356x415 h
Capacity litres	90
Weight gr.	3915
Standard colour*	■
Bottom	solid
Long sides	closed
Short sides	closed
Lifting	holes
Label holder: ORD. NO. F PZ 0010 00 99 , ORD. NO. F PZ 9751 00 07 . See page G15	

■ 01

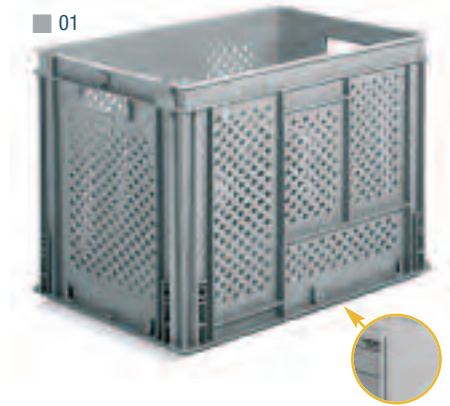

ORD. NO.	DIM. mm
F PA 8051 DO 01	600x400x430 h
External dim. mm	600x400x430 h
Internal dim. mm	557x357x415 h
Capacity litres	90
Weight gr.	3610
Standard colour*	■
Bottom	solid
Long sides	perforated
Short sides	perforated
Lifting	holes
Label holder: ORD. NO. F PZ 0010 00 99 , ORD. NO. F PZ 9751 00 07 . See page G15	

■ 01

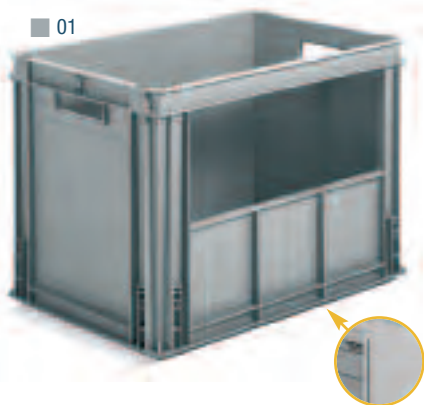

ORD. NO.	DIM. mm
F PA 8051 SO 01	600x400x430 h
External dim. mm	600x400x430 h
Internal dim. mm	557x357x415 h
Window dim. mm	462x180 h
Capacity litres	90
Weight gr.	3625
Standard colour*	■
Bottom	solid
Long sides	closed
Short sides	closed
Lifting	holes
Label holder: ORD. NO. F PZ 0010 00 99 , ORD. NO. F PZ 9751 00 07 . See page G15	

■ 01



ORD. NO.	DIM. mm
F PA 8051 RO 01	600x400x430 h
External dim. mm	600x400x430 h
Internal dim. mm	557x357x415 h
Window dim. mm	260x183 h
Capacity litres	90
Weight gr.	3780
Standard colour*	■
Bottom	solid
Long sides	closed
Short sides	closed
Lifting	holes
Label holder: ORD. NO. F PZ 0010 00 99 , ORD. NO. F PZ 9751 00 07 . See page G15	

■ *On request other colours available

■ KEY



The stacking containers marked with this symbol can be used to store foodstuffs.



Containers with this symbol are made of completely recyclable plastic material.



GREY
F.....01



SERIES STORAGE ATHENA

■ 01



Reinforced bottom

**ORD. NO.**

DIM. mm

F PA 8551 AO 01 800x600x120 h

External dim. mm 800x600x120 h

Internal dim. mm 757x557x86 h

Capacity litres 49

Weight gr. 3450

Standard colour* ■

Bottom **reinforced**Long sides **closed**Short sides **closed**Lifting **bars**Label holder: ORD. NO. **F PZ 0010 00 99**

See page G15

■ 01



Reinforced bottom

**ORD. NO.**

DIM. mm

F PA 8751 AO 01 800x600x170 h

External dim. mm 800x600x170 h

Internal dim. mm 758x555x137 h

Capacity litres 69

Weight gr. 3920

Standard colour* ■

Bottom **reinforced**Long sides **closed**Short sides **closed**Lifting **bars**Label holder: ORD. NO. **F PZ 0010 00 99**,ORD. NO. **F PZ 9751 00 07**. See page G15

■ 01



Reinforced bottom

**ORD. NO.**

DIM. mm

F PA 8951 AO 01 800x600x220 h

External dim. mm 800x600x220 h

Internal dim. mm 757x556x188 h

Capacity litres 90

Weight gr. 4630

Standard colour* ■

Bottom **reinforced**Long sides **closed**Short sides **closed**Lifting **bars**Label holder: ORD. NO. **F PZ 0010 00 99**,ORD. NO. **F PZ 9751 00 07**. See page G15

■ 01



Reinforced bottom

**ORD. NO.**

DIM. mm

F PA 9351 AO 01 800x600x325 h

External dim. mm 800x600x325 h

Internal dim. mm 756x555x294 h

Capacity litres 130

Weight gr. 5270

Standard colour* ■

Bottom **reinforced**Long sides **closed**Short sides **closed**Lifting **bars**Label holder: ORD. NO. **F PZ 0010 00 99**,ORD. NO. **F PZ 9751 00 07**. See page G15

■ 01



Reinforced bottom

**ORD. NO.**

DIM. mm

F PA 9751 AO 01 800x600x430 h

External dim. mm 800x600x430 h

Internal dim. mm 756x555x395 h

Capacity litres 175

Weight gr. 6200

Standard colour* ■

Bottom **reinforced**Long sides **closed**Short sides **closed**Lifting **bars**Label holder: ORD. NO. **F PZ 0010 00 99**,ORD. NO. **F PZ 9751 00 07**. See page G15

■ Detail of stacking containers with reinforced bottom 800x600 mm

■ *On request other colours available

GREY
F.....01

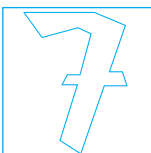
**KEY**

The stacking containers marked with this symbol can be used to store foodstuffs.



Containers with this symbol are made of completely recyclable plastic material.



DIMENSIONS = 800x600 mm

SERIES STORAGE ATHENA

CONTAINER INCLUDING 1 SET OF FOUR FEET

■ Supplied assembled

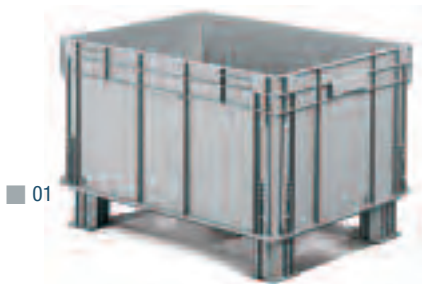

ORD. NO.	DIM. mm
F PA 8551 AD 01	800x600x220 h
With 120 mm high container	
Capacity litres	49
F PA 8751 AD 01	800x600x270 h
With 170 mm high container	
Capacity litres	69
F PA 8951 AD 01	800x600x320 h
With 220 mm high container	
Capacity litres	90
F PA 9351 AD 01	800x600x425 h
With 325 mm high container	
Capacity litres	130
F PA 9751 AD 01	800x600x530 h
With 430 mm high container	
Capacity litres	175

CONTAINER INCLUDING 1 SET OF FOUR FEET AND 1 PAIR OF CONNECTION PIECES

■ Supplied assembled



ORD. NO.	DIM. mm
F PA 8551 AE 01	800x600x245 h
With 120 mm high container	
Capacity litres	49
F PA 8751 AE 01	800x600x295 h
With 170 mm high container	
Capacity litres	69
F PA 8951 AE 01	800x600x345 h
With 220 mm high container	
Capacity litres	90
F PA 9351 AE 01	800x600x450 h
With 325 mm high container	
Capacity litres	130
F PA 9751 AE 01	800x600x555 h
With 430 mm high container	
Capacity litres	175

CONTAINER INCLUDING 1 SET OF FOUR Ø 100 mm RUBBER SWIVEL WHEELS

■ Supplied assembled



ORD. NO.	DIM. mm
F PA 8551 AF 01	800x600x245 h
With 120 mm high container	
Capacity litres	49
F PA 8751 AF 01	800x600x295 h
With 170 mm high container	
Capacity litres	69
F PA 8951 AF 01	800x600x345 h
With 220 mm high container	
Capacity litres	90
F PA 9351 AF 01	800x600x450 h
With 325 mm high container	
Capacity litres	130
F PA 9751 AF 01	800x600x555 h
With 430 mm high container	
Capacity litres	175



■ The containers can be stacked thanks to the 4 feet which enter inside the container below



■ The 2 connection pieces allow the containers to be stacked



■ The containers can be stacked thanks to the 4 wheels which enter inside the container below

■ KEY



The stacking containers marked with this symbol can be used to store foodstuffs.



Containers with this symbol are made of completely recyclable plastic material.

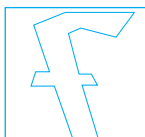

GREY
F.....01

SERIES STORAGE ATHENA

HINGED LID SERIES F PA 300x200 / 400x300 / 600x400



Hinged lid

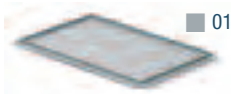

01

ORD. NO.

F PA 0351 00 01

Hinged lid mm

300x200

Weight gr. 155

Standard colour* ■

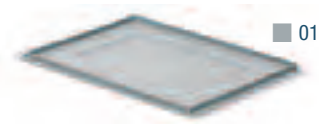

01

ORD. NO.

F PA 0651 00 01

Hinged lid mm

400x300

Weight gr. 320

Standard colour* ■



01

ORD. NO.

F PA 0951 00 01

Hinged lid mm

600x400

Weight gr. 722

Standard colour* ■

COVER SERIES F PA 400x300 / 600x400 / 800x600



Cover

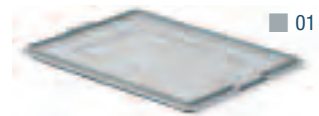

01

ORD. NO.

F PA 1B51 00 01

Lid mm

400x300

Weight gr. 375

Standard colour* ■



01

ORD. NO.

F PA 1C51 00 01

Lid mm

600x400

Weight gr. 750

Standard colour* ■



01

ORD. NO.

F PA 1251 01 01

Lid mm

800x600

Weight gr. 1685

Standard colour* ■

For containers ORD. NO. F PA 8551 A0 01

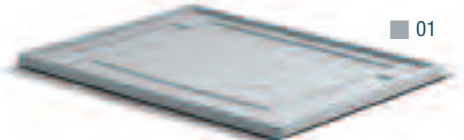

01

ORD. NO.

F PA 1251 00 01

Lid mm

800x600

Weight gr. 1710

Standard colour* ■

For containers ORD. NO. F PA 8751 A0 01, F PA 8951 A0 01, F PA 9351 A0 01, F PA 9751 A0 01

■ *On request other colours available

SLIDING LID SERIES F PA 400x300



Sliding lid

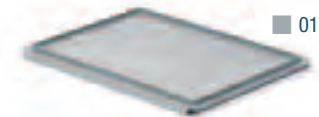

01

ORD. NO.

F PA 1651 00 01

Sliding lid mm

400x300

Weight gr. 440

Standard colour* ■

■ Not suitable for ORD. NO. F PA 3251 A0 01

ORD. NO. F PZ 0681 00 13

Pair of sliding hooks suitable for Athena series containers with the following heights: 50/120/170/220/320/430 mm.

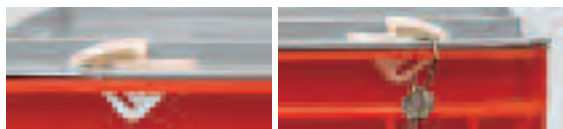

■ Kick-in locks not suitable for stacking containers
ORD. NO. F PA 5651 A0 ..

GREY
F.....01

KEY ■



The stacking containers marked with this symbol can be used to store foodstuffs.

Containers with this symbol are made of completely recyclable plastic material.



DIMENSIONS = 400x300 / 600x400 mm

SERIES STORAGE ATHENA

SUB-DIVIDING CONTAINERS FOR SERIES ATHENA 400x300

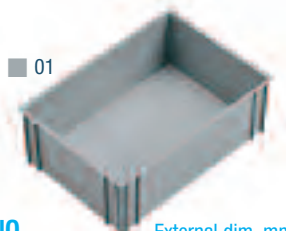

01

ORD. NO. External dim. mm

F PP 4051 00 01 250x176x90 h

Standard colour

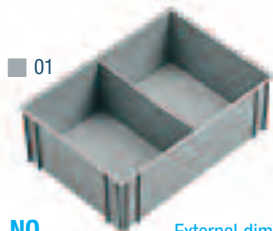

01

ORD. NO. External dim. mm

F PP 4551 00 01 256x176x90 h

Standard colour

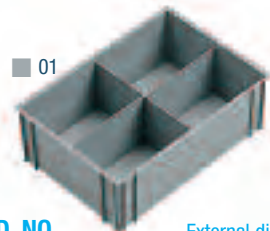

01

ORD. NO. External dim. mm

F PP 5051 00 01 256x176x90 h

Standard colour

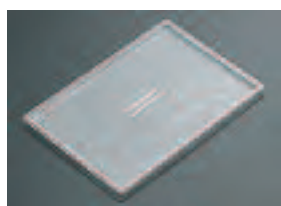

96



ORD. NO. External dim. mm

F PP 9368 00 96 252x178

Colour transparent

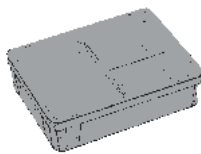

STACKING CONTAINER
DIVIDED WITH

1 ORD. NO. F PP 4051 00 01
1 ORD. NO. F PP 4551 00 01

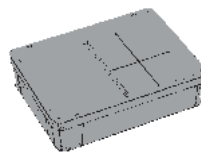

STACKING CONTAINER
DIVIDED WITH

1 ORD. NO. F PP 4051 00 01
1 ORD. NO. F PP 5051 00 01

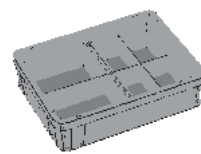

STACKING CONTAINER
DIVIDED WITH

1 ORD. NO. F PP 4551 00 01
1 ORD. NO. F PP 5051 00 01

SUB-DIVIDING CONTAINERS FOR SERIES ATHENA - THEMA 600x400

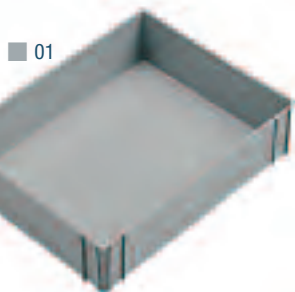

01

ORD. NO. External dim. mm

F PP 6051 00 01 358x278x90 h

Standard colour

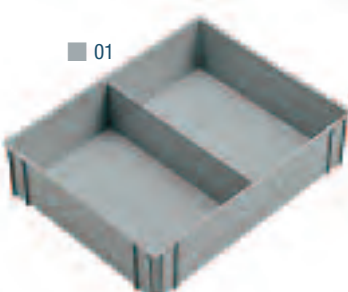

01

ORD. NO. External dim. mm

F PP 6551 00 01 358x278x90 h

Standard colour

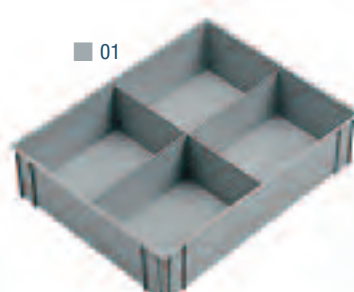

01

ORD. NO. External dim. mm

F PP 7051 00 01 358x278x90 h

Standard colour



96



ORD. NO. External dim. mm

F PP 9668 00 96 358x278

Colour transparent

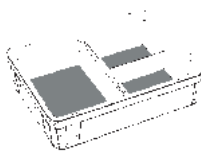

STACKING CONTAINER
DIVIDED WITH

1 ORD. NO. F PP 6051 00 01
1 ORD. NO. F PP 6551 00 01

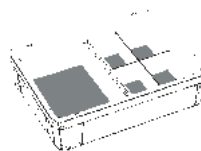

STACKING CONTAINER
DIVIDED WITH

1 ORD. NO. F PP 6051 00 01
1 ORD. NO. F PP 7051 00 01

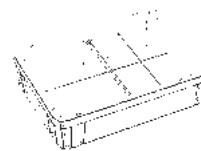

STACKING CONTAINER
DIVIDED WITH

1 ORD. NO. F PP 6551 00 01
1 ORD. NO. F PP 7051 00 01

KEY



Containers with this symbol are made of completely recyclable plastic material.



TRANSPARENT
F. 99

GREY
F. 01



SERIES STORAGE ATHENA

SLOTTED PARTITIONS FOR STACKING CONTAINERS SERIES
ATHENA - THEMA

HEIGHT mm 45 h



ORD. NO.	DIM mm	increments mm	for containers series
F HN 1320 00 01	255x45	20	400x300
F HN 1420 00 01	355x45	20	400x300 / 600x400
F HN 1620 00 01	555x45	20	600x400



HEIGHT mm 70 h

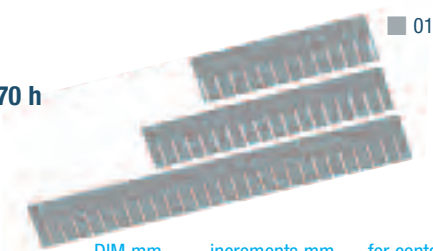

ORD. NO.	DIM mm	increments mm	for containers series
F HN 1340 00 01	255x70	20	400x300
F HN 1440 00 01	355x70	20	400x300 / 600x400
F HN 1640 00 01	555x70	20	600x400

HEIGHT mm 90 h

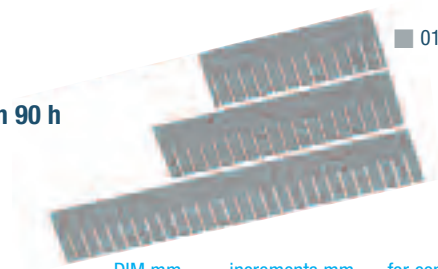

ORD. NO.	DIM mm	increments mm	for containers series
F HN 1350 00 01	255x90	20	400x300
F HN 1450 00 01	355x90	20	400x300 / 600x400
F HN 1650 00 01	555x90	20	600x400

HEIGHT mm 120 h

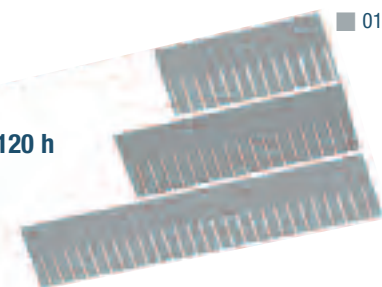

ORD. NO.	DIM mm	increments mm	for containers series
F HN 1360 00 01	255x120	20	400x300
F HN 1460 00 01	355x120	20	400x300 / 600x400
F HN 1660 00 01	555x120	20	600x400

HEIGHT mm 180 h

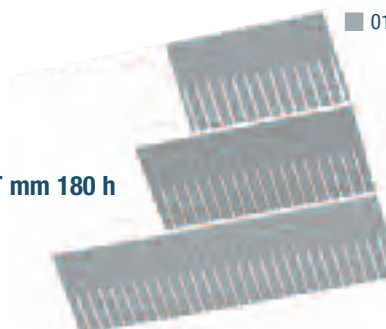

ORD. NO.	DIM mm	increments mm	for containers series
F HN 1370 00 01	255x180	20	400x300
F HN 1470 00 01	355x180	20	400x300 / 600x400
F HN 1670 00 01	555x180	20	600x400

COVER OR LAYER SEPARATOR

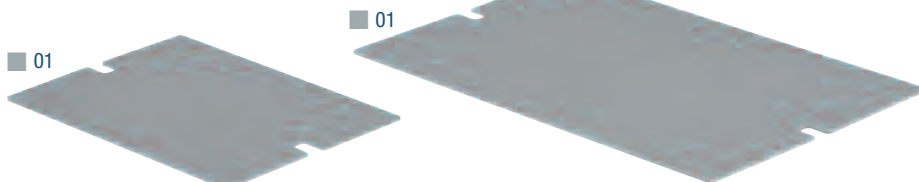

ORD. NO.	DIM. mm
F HN 5130 00 01	355x255
For containers Athena-Thema	400x300
Standard colour ■	

ORD. NO.	DIM. mm
F HN 5140 00 01	555x355
For containers Athena-Thema	600x400
Standard colour ■	

■ example of use as a cover or layer separator

GREY
F.....01

INFO ■

www.famispa.com



LABEL HOLDER FOR ATHENA AND NETTUNO SERIES 400x300



07

ORD. NO.	External dim. mm
F PZ 9551 00 07	150x85
Standard colour ■	

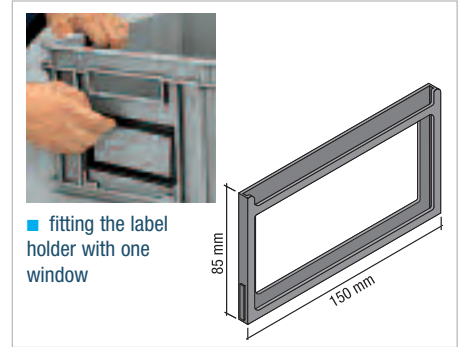
LABEL	ORD. NO.	External dim. mm
	F PZ 0920 00 00	145x81
Quantity per sheet: 4		



LABEL HOLDER FOR ATHENA AND NETTUNO SERIES 600x400



07

ORD. NO.	External dim. mm
F PZ 9751 00 07	215x85
Standard colour ■	

LABEL	ORD. NO.	External dim. mm
	F PZ 0940 00 00	210x81
Quantity per sheet: 3		

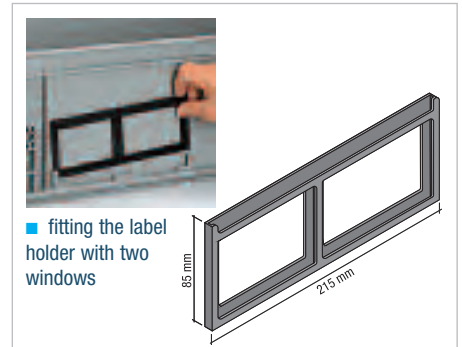

METAL CLIPS FOR ATHENA - THEMA - MINERVA SERIES



99

ORD. NO. F PZ 0010 00 99

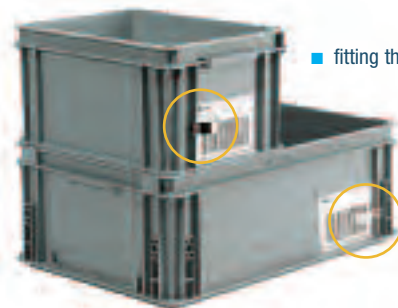

TROLLEYS FOR LIFTING AND TRANSPORTING
STORAGE AND STACKING CONTAINERS SERIES
ATHENA - ODETTTE 600x400 mm

ORD. NO.	LOAD CAPACITY kg
F CR 0441 00 04	300
Only for lifting series Athena and Odette 600x400 mm	
2 swivel wheels in rubber Ø 125 mm	
2 fixed wheels in polyurethane Ø 125 mm	

04



transport system

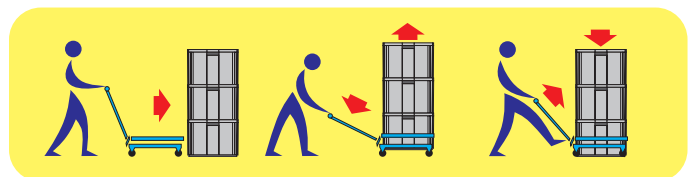

INFO

RAL 5012 F.04

GALVANISED F.99

BLACK F.07



www.famispa.com

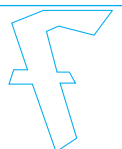

SERIES STORAGE ODETTTE KLT

- GOOD RESISTANCE TO OILS
- DIFFERENT AUTOMATED HANDLING OPTIONS
- STRONG ERGONOMICS HANDLES
- EXCELLENT LEVEL OF SAFETY AND RESISTANCE
- SMOOTH BOTTOM FOR NOISELESS MOVEMENT ON CONVEYORS
- PERFORATED BOTTOM FOR WATER DRAINAGE



BLUE
F.27

KEY ■

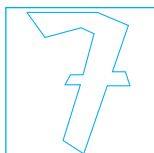

Containers with this symbol are made of completely recyclable plastic material.



DIMENSIONS = 600x400 / 400x300 / 300x200 mm

SERIES STORAGE ODETTE KLT

■ 27



ORD. NO.	DIM. mm
F PC 7251 00 27	600x400x280 h
External dim. mm	600x400x280 h
Internal dim. mm	544x359x262 h
Capacity litres	51,9
Weight gr.	2670
Standard colour	■

ORD. NO.	DIM. mm
F PC 6651 00 27	600x400x147,5 h
External dim. mm	600x400x147,5 h
Internal dim. mm	544x359x129,5 h
Capacity litres	25,3
Weight gr.	1900
Standard colour	■

■ 27



ORD. NO.	DIM. mm
F PC 5051 00 27	400x300x280 h
External dim. mm	400x300x280 h
Internal dim. mm	346x260x262 h
Capacity litres	24,1
Weight gr.	1700
Standard colour	■

ORD. NO.	DIM. mm
F PC 4251 00 27	400x300x147,5 h
External dim. mm	400x300x147,5 h
Internal dim. mm	346x260x129,5 h
Capacity litres	13,1
Weight gr.	1080
Standard colour	■

ORD. NO.	DIM. mm
F PC 2351 00 27	300x200x147,5 h
External dim. mm	300x200x147,4 h
Internal dim. mm	243x162x129,7 h
Capacity litres	5,3
Weight gr.	570
Standard colour	■

■ KEY



Containers with this symbol are made of completely recyclable plastic material.



■ BLUE
F.....27

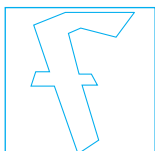

SERIES STORAGE ODETTE

- FOR AUTOMATIC HANDLING
- OIL RESISTANT
- FOR STORAGE SYSTEM
- FOR MANUAL HANDLING

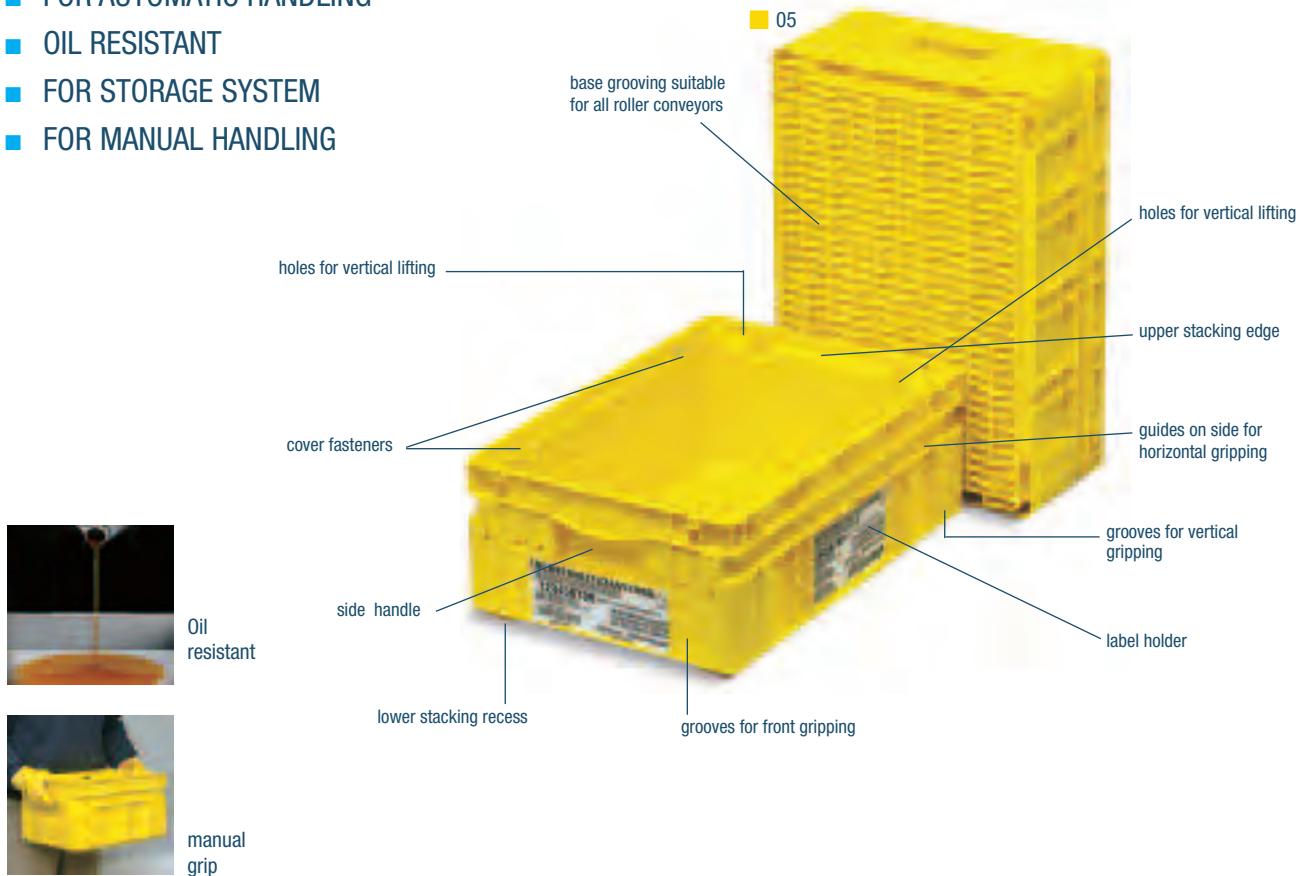

FAMI is the only Italian company to produce containers approved by the "Odette" European commission. They have the following features:

- 8 different automatic handling systems;
- tough ergonomic handles;
- good ratio between external volume and useful volume;
- reinforced and structured bottom for easy sliding along all kinds of roller conveyors;
- 2 label holders for A5 "bar code" labels in "Odette" standard;
- high level of safety (coefficient 3 measured in various crash tests).

PLASTIC PALLETS FOR ODETTE STACKING CONTAINERS

Plastic pallet for **Odette** containers with galvanised steel edges on all 4 sides

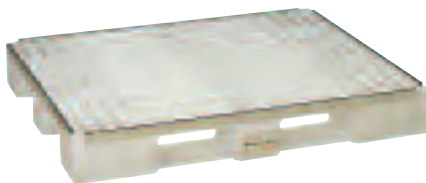

ORD. NO.	EXTERNAL DIM. mm
F PU 2140 00 13	1200x800x150 h
Load capacity on floor kg 4000	
Load capacity on fork lift truck kg 1500	
Weight kg	14,50

ORD. NO.	EXTERNAL DIM. mm
F PU 3140 00 13	1200x1000x150 h
Load capacity on floor kg 4000	
Load capacity on fork lift truck kg 1500	
Weight kg	17,60

YELLOW
F. 05

GALVANISED F. 99

KEY ■



Containers with this symbol are made of completely recyclable plastic material.

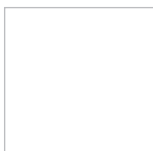
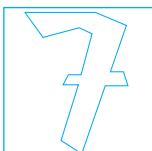

DIMENSIONS: 300x200 / 400x200 / 600x400 mm

SERIES STORAGE ODETTTE

ODETTE SERIES STACKING CONTAINERS
F PC 300x200 / 400x300 / 600x400



■ 05



ORD. NO.	DIM. mm
F PC 2451 00 05	300x200x147,5 h
External dim. mm	300x200x147,5 h
Internal dim. mm	234x158x126 h
Capacity litres	4,6
Weight gr.	610
Standard colour*	■
Bottom	solid
Long sides	closed
Short sides	closed
Lifting	bars

■ 05



ORD. NO.	DIM. mm
F PC 4851 00 05	400x300x220 h
External dim. mm	400x300x220 h
Internal dim. mm	336x262x187 h
Capacity litres	15,8
Weight gr.	1820
Standard colour*	■
Bottom	solid
Long sides	closed
Short sides	closed
Lifting	bars



■ 05



ORD. NO.	DIM. mm
F PC 6851 00 05	600x400x220 h
External dim. mm	600x400x220 h
Internal dim. mm	535x361x185 h
Capacity litres	34,8
Weight gr.	2880
Standard colour*	■
Bottom	solid
Long sides	closed
Short sides	closed
Lifting	bars

■ 05



ORD. NO.	DIM. mm
F PC 7651 00 05	600x400x320 h
External dim. mm	600x400x320 h
Internal dim. mm	536x361x282 h
Capacity litres	53
Weight gr.	3905
Standard colour*	■
Bottom	solid
Long sides	closed
Short sides	closed
Lifting	bars

LID FOR ODETTTE SERIES STACKING CONTAINERS F PC

■ 05



ORD. NO.	DIM. mm
F PC 0351 00 05	300x200
Weight gr.	106
Standard colour*	■

■ 05



ORD. NO.	DIM. mm
F PC 0651 00 05	400x300
Weight gr.	240
Standard colour*	■

■ 05



ORD. NO.	DIM. mm
F PC 0951 00 05	600x400
Weight gr.	500
Standard colour*	■

■ KEY



Containers with this symbol are made of completely recyclable plastic material.



■ YELLOW
F.....05



SERIES STORAGE ODETTE

■ 05



NEW

Label holder for label dim.
210x105 mm h

ORD. NO.

DIM. mm

F PC 9651 00 05 **1000x400x232 h**

External dim. mm 1000x400x232 h

Internal dim. mm 935x355x197 h

Capacity litres 65

Weight gr. 3500

Standard colour* ■

Bottom **solid**Long sides **closed**Short sides **closed**Lifting **bars**■ Detail of stacking containers with reinforced bottom
ORD. NO. F PC 9651 00 05

■ *On request other colours available

YELLOW
F. 05

KEY ■

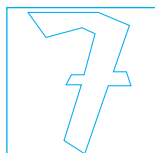

Containers with this symbol are made of completely recyclable plastic material.



- GOOD COMPARISON BETWEEN QUALITY AND PRICE
- SUITABLE FOR STORE FOODSTUFFS
- LIGHT IN WEIGHT



Oil resistant



The stacking containers marked with this symbol can be used to store foodstuffs



Strong and resistant to high and low temperatures



■ 01

THEMA CONTAINERS SERIES F PA 600x400

■ *On request other colours available

■ 01



ORD. NO.

DIM. mm

F PB 6851 AO 01 600x400x220 h

External dim. mm	600x400x220 h
Internal dim. mm	555x355x203 h
Capacity litres	40
Weight gr.	1960
Standard colour*	■
Bottom	solid
Long sides	closed
Short sides	closed
Lifting	bars

Label holder: ORD. NO. **F PZ 0010 00 99**
See page G15

■ 01



ORD. NO.

DIM. mm

F PB 6851 BO 01 600x400x220 h

External dim. mm	600x400x220 h
Internal dim. mm	555x354x203 h
Capacity litres	40
Weight gr.	1950
Standard colour*	■
Bottom	solid
Long sides	closed
Short sides	closed
Lifting	holes

Label holder: ORD. NO. **F PZ 0010 00 99**
See page G15

■ 01

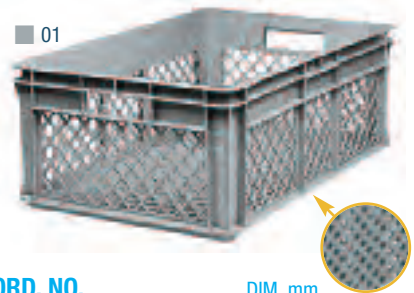

ORD. NO.

DIM. mm

F PB 6851 FO 01 600x400x220 h

External dim. mm	600x400x220 h
Internal dim. mm	556x356x200 h
Capacity litres	40
Weight gr.	1475
Standard colour*	■
Bottom	perforated
Long sides	perforated
Short sides	perforated
Lifting	holes

Label holder: ORD. NO. **F PZ 0010 00 99**
See page G15

■ **KEY**



The stacking containers marked with this symbol can be used to store foodstuffs.



Containers with this symbol are made of completely recyclable plastic material.



■ GREY
F.....01

SERIES STORAGE MINERVA

- MAXIMUM VOLUME REDUCTION BY EMPTY CONTAINERS
- IDEAL FOR TRANSPORT ON TRUCK DELIVERIES
- GOOD COMPARISON BETWEEN QUALITY AND PRICE



Oil resistant



The stacking containers marked with this symbol can be used to store foodstuffs



Strong and resistant to high and low temperatures



■ 01



The Minerva series stacking containers respect the unified european dimensions 600x400 mm and can be therefore perfectly palletized.



TROLLEYS FOR LIFTING AND TRANSPORTING
STACKING CONTAINERS SERIES MINERVA 600x400 mm

ORD. NO.	LOAD CAPACITY kg
F CR 0461 00 04	300
Only for lifting series Minerva	
2 rubber swivel wheels Ø 125 mm	
2 polyurethane fixed wheels Ø 125 mm	



■ how to use the lifting trolley



■ 04



GREY
F.....01

RAL 5012 F.....04

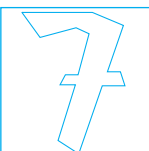

KEY ■



The stacking containers marked with this symbol can be used to store foodstuffs.



Containers with this symbol are made of completely recyclable plastic material.



DIMENSIONS = 600x400

SERIES STORAGE MINERVA

STACKING CONTAINERS SERIES F PE 600x400

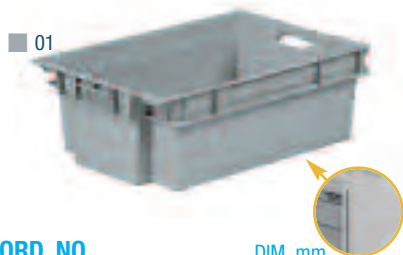

ORD. NO.	DIM. mm
F PE 6851 BO 01	600x400x200 h
External dim. mm	600x400x200 h
Internal dim. mm	455x338x180 h
Capacity litres	32
Weight gr.	1750
Standard colour*	■
Bottom	solid
Long sides	closed
Short sides	closed
Lifting	holes
Label holder: ORD. NO. F PZ 0010 00 99 See page G15	

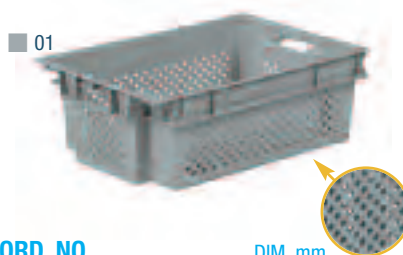

ORD. NO.	DIM. mm
F PE 6851 FO 01	600x400x200 h
External dim. mm	600x400x200 h
Internal dim. mm	458x338x177 h
Capacity litres	32
Weight gr.	1520
Standard colour*	■
Bottom	perforated
Long sides	perforated
Short sides	perforated
Lifting	holes
Label holder: ORD. NO. F PZ 0010 00 99 See page G15	



ORD. NO.	DIM. mm
F PE 7651 BO 01	600x400x300 h
External dim. mm	600x400x300 h
Internal dim. mm	455x338x272 h
Capacity litres	50
Weight gr.	2500
Standard colour*	■
Bottom	solid
Long sides	closed
Short sides	closed
Lifting	holes
Label holder: ORD. NO. F PZ 0010 00 99 See page G15	

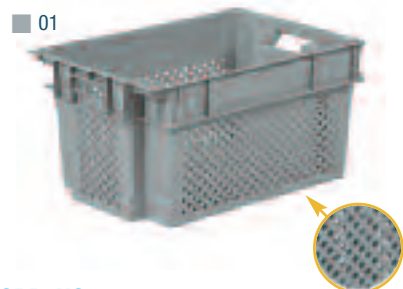

ORD. NO.	DIM. mm
F PE 7651 FO 01	600x400x300 h
External dim. mm	600x400x300 h
Internal dim. mm	455x337x270 h
Capacity litres	50
Weight gr.	2320
Standard colour*	■
Bottom	perforated
Long sides	perforated
Short sides	perforated
Lifting	holes
Label holder: ORD. NO. F PZ 0010 00 99 See page G15	



ORD. NO.	DIM. mm
F PE 8051 BO 01	600x400x400 h
External dim. mm	600x400x400 h
Internal dim. mm	453x337x370 h
Capacity litres	70
Weight gr.	2940
Standard colour*	■
Bottom	solid
Long sides	closed
Short sides	closed
Lifting	holes
Label holder: ORD. NO. F PZ 0010 00 99 See page G15	



ORD. NO.	DIM. mm
F PE 8051 FO 01	600x400x400 h
External dim. mm	600x400x400 h
Internal dim. mm	455x337x372 h
Capacity litres	70
Weight gr.	2865
Standard colour*	■
Bottom	perforated
Long sides	perforated
Short sides	perforated
Lifting	holes
Label holder: ORD. NO. F PZ 0010 00 99 See page G15	

SNAP SPRING FOR LID CLOSING



ORD. NO. **F PZ 0020 00 99** ■ 99

LID SERIES F PE 600x400

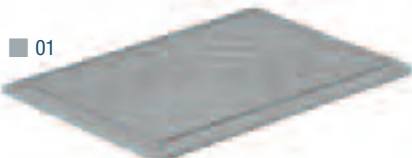

ORD. NO.	DIM. mm
F PE 0951 00 01	600x400
Weight gr.	960
Standard colour*	■

■ *On request other colours available

KEY



The stacking containers marked with this symbol can be used to store foodstuffs.



Containers with this symbol are made of completely recyclable plastic material.



GREY
F.....01

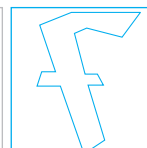

SERIES STORAGE DELTA

- MAXIMUM VOLUME REDUCTION BY EMPTY CONTAINERS
- IDEAL FOR TRANSPORT ON TRUCK DELIVERIES
- STACKABLE USING THE SUPPORT



- the flush handles offer a safe and easy grip even for gloved hand

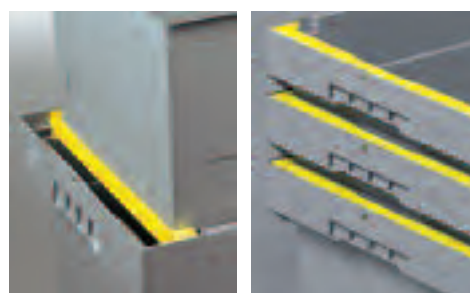

- example of stacking full containers with opened supports and with closed supports



- the lid can be fastened with a security seal



- The support (**pic. 1**) is pushed to its stop (**pic. 2**) and is blocked by pressing downwards (**pic. 3**).



GREY
F.....01

KEY ■



The stacking containers marked with this symbol can be used to store foodstuffs.



Containers with this symbol are made of completely recyclable plastic material.

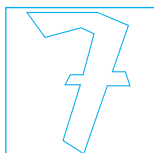

DIMENSIONS = 600x400

SERIES STORAGE DELTA

STACKING CONTAINERS SERIES F PD 600x400

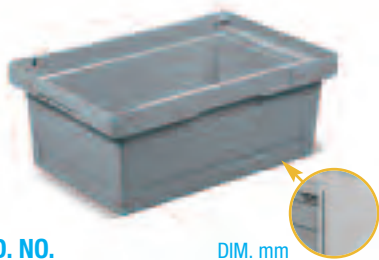

ORD. NO.	DIM. mm
F PD 6851 AO 01	600x400x225 h
External dim. mm	600x400x225 h
Internal dim. mm	499x329x195 h
Capacity litres	38
Weight gr.	1742
Standard colour*	■
Bottom	solid
Long sides	closed
Short sides	closed
Lifting	bars



ORD. NO.	DIM. mm
F PD 7651 AO 01	600x400x325 h
External dim. mm	600x400x325 h
Internal dim. mm	499x329x295 h
Capacity litres	58
Weight gr.	2332
Standard colour*	■
Bottom	solid
Long sides	closed
Short sides	closed
Lifting	bars



ORD. NO.	DIM. mm
F PD 8051 AO 01	600x400x425 h
External dim. mm	600x400x425 h
Internal dim. mm	499x329x395 h
Capacity litres	74
Weight gr.	2858
Standard colour*	■
Bottom	solid
Long sides	closed
Short sides	closed
Lifting	bars



ORD. NO.	DIM. mm
F PD 6851 AB 01	600x400x230 h
External dim. mm	600x400x230 h
Internal dim. mm	499x329x195 h
Capacity litres	38
Weight gr.	1930
Standard colour*	■
Bottom	solid
Long sides	closed
Short sides	closed
Lifting	bars

Complete with supports for stacking



ORD. NO.	DIM. mm
F PD 7651 AB 01	600x400x330 h
External dim. mm	600x400x330 h
Internal dim. mm	499x329x295 h
Capacity litres	58
Weight gr.	2524
Standard colour*	■
Bottom	solid
Long sides	closed
Short sides	closed
Lifting	bars

Complete with supports for stacking



ORD. NO.	DIM. mm
F PD 8051 AB 01	600x400x430 h
External dim. mm	600x400x430 h
Internal dim. mm	499x329x395 h
Capacity litres	74
Weight gr.	3055
Standard colour*	■
Bottom	solid
Long sides	closed
Short sides	closed
Lifting	bars

Complete with supports for stacking

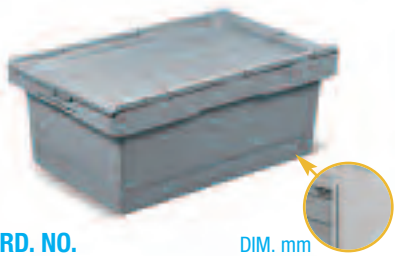

ORD. NO.	DIM. mm
F PD 6851 AA 01	610x400x240 h
External dim. mm	610x400x240 h
Internal dim. mm	499x329x195 h
Capacity litres	38
Weight gr.	2640
Standard colour*	■
Bottom	solid
Long sides	closed
Short sides	closed
Lifting	bars

Complete with hinged lid



ORD. NO.	DIM. mm
F PD 7651 AA 01	610x400x340 h
External dim. mm	610x400x340 h
Internal dim. mm	499x329x295 h
Capacity litres	58
Weight gr.	3230
Standard colour*	■
Bottom	solid
Long sides	closed
Short sides	closed
Lifting	bars

Complete with hinged lid



ORD. NO.	DIM. mm
F PD 8051 AA 01	610x400x440 h
External dim. mm	610x400x440 h
Internal dim. mm	499x329x395 h
Capacity litres	74
Weight gr.	3765
Standard colour*	■
Bottom	solid
Long sides	closed
Short sides	closed
Lifting	bars

Complete with hinged lid

SERIES STORAGE NETTUNO

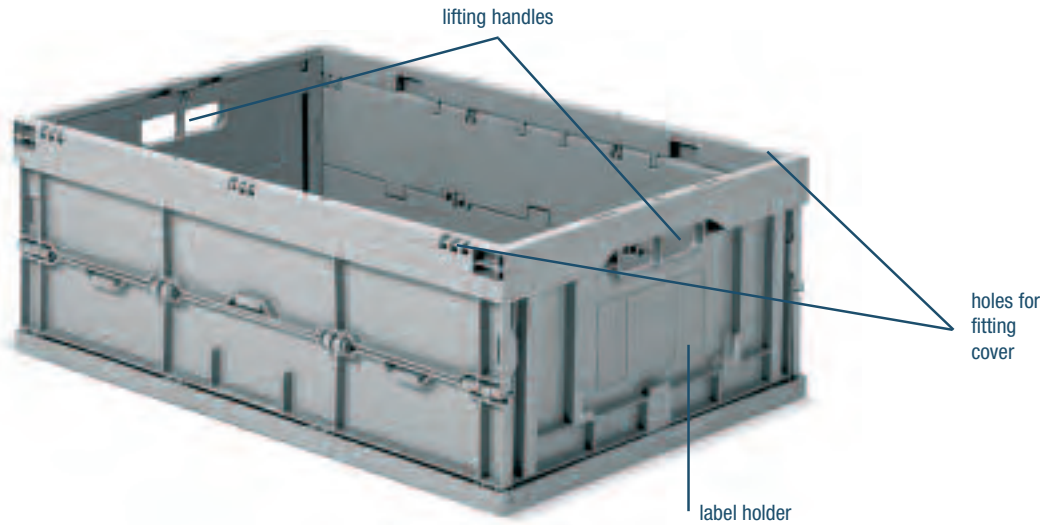

Oil resistant



The stacking containers marked with this symbol can be used to store foodstuffs.

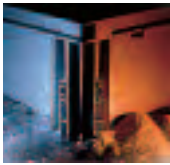

Resistant to high and low temperatures



NETTUNO STACKING CONTAINERS SERIES F PF 400x300

■ 01



■ 01



■ Complete with hinged lid

■ Label holder: ORD. NO. F PZ 9551 00 07 See page G15

■ *On request other colours available

ORD. NO.

DIM. mm

ORD. NO.	DIM. mm
F PF 4851 BB 01	400x300x220 h
External dim. mm	400x300x220 h
Closed dim. mm	400x300x70 h
Capacity litres	22
Weight gr.	1308
Standard colour*	■
Bottom	solid
Long sides	closed
Short sides	closed
Lifting	holes

ORD. NO.

DIM. mm

ORD. NO.	DIM. mm
F PF 4851 BA 01	400x300x230 h
External dim. mm	400x300x230 h
Closed dim. mm	400x300x85 h
Capacity litres	22
Weight gr.	1654
Standard colour*	■
Bottom	solid
Long sides	closed
Short sides	closed
Lifting	holes

GREY F. 01

KEY ■

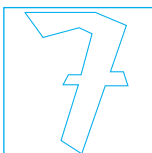

The stacking containers marked with this symbol can be used to store foodstuffs.

Containers with this symbol are made of completely recyclable plastic material.



DIMENSIONS = 600x400

SERIES STORAGE NETTUNO

NETTUNO STACKING CONTAINERS
SERIES F PF 600x400

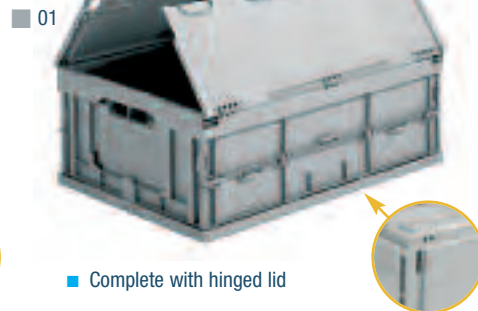
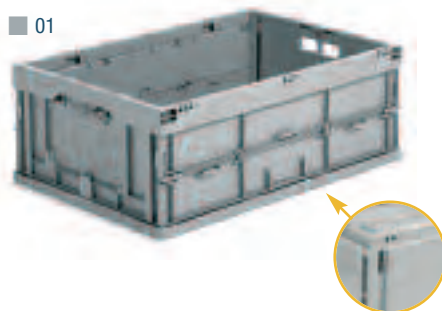

■ Complete with hinged lid

■ Label holder: ORD. NO. F PZ 9751 00 07
See page G15

■ *On request other colours available

ORD. NO.	DIM. mm
F PF 6851 BB 01	600x400x220 h
External dim. mm	600x400x220 h
Closed dim. mm	600x400x68 h
Capacity litres	45
Weight gr.	2170
Standard colour*	■
Bottom	solid
Long sides	closed
Short sides	closed
Lifting	holes

ORD. NO.	DIM. mm
F PF 6851 BA 01	600x400x230 h
External dim. mm	600x400x230 h
Closed dim. mm	600x400x80 h
Capacity litres	45
Weight gr.	2870
Standard colour*	■
Bottom	solid
Long sides	closed
Short sides	closed
Lifting	holes

NETTUNO STACKING CONTAINERS
SERIES F PF 600x400

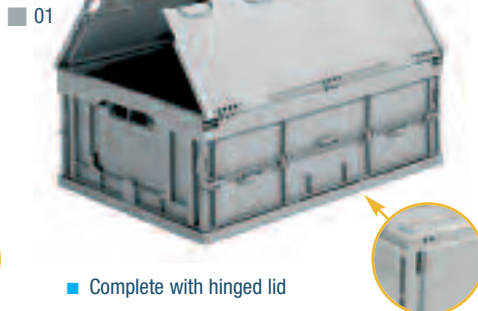
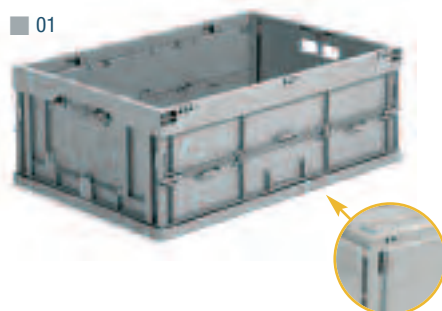

■ Complete with hinged lid

■ Label holder: ORD. NO. F PZ 9751 00 07
See page G15

■ *On request other colours available

ORD. NO.	DIM. mm
F PF 7651 BB 01	600x400x320 h
External dim. mm	600x400x320 h
Closed dim. mm	600x400x70 h
Capacity litres	65
Weight gr.	2642
Standard colour*	■
Bottom	solid
Long sides	closed
Short sides	closed
Lifting	holes

ORD. NO.	DIM. mm
F PF 7651 BA 01	600x400x330 h
External dim. mm	600x400x330 h
Closed dim. mm	600x400x82 h
Capacity litres	65
Weight gr.	3338
Standard colour*	■
Bottom	solid
Long sides	closed
Short sides	closed
Lifting	holes

■ KEY



The stacking containers marked with this symbol can be used to store foodstuffs.



Containers with this symbol are made of completely recyclable plastic material.

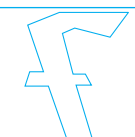

GREY
F.....01

SERIES STORAGE ZEUS

- SHOCK RESISTANT
- AVAILABLE IN 5 COLOURS
- STRONG STACKING EDGES

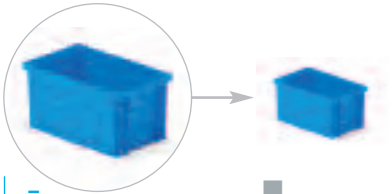

-	■
-	■
-	■
-	■
-	■
ORD. NO. F PJ 0151 00 04	■
-	■
External dim. mm	145x90x70 h
Internal dim. mm	123x80x63 h
Capacity litres	0,9
Weight gr.	70

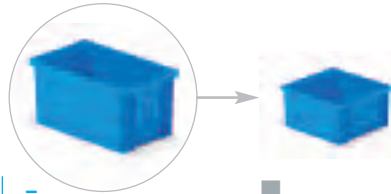

-	■
-	■
-	■
-	■
-	■
ORD. NO. F PJ 1751 00 04	■
-	■
External dim. mm	145x140x70 h
Internal dim. mm	127x123x63 h
Capacity litres	1,4
Weight gr.	90



size 272-2

ORD. NO. F PJ 2551 00 01	■
ORD. NO. F PJ 2551 00 02	■
ORD. NO. F PJ 2551 00 03	■
ORD. NO. F PJ 2551 00 04	■
ORD. NO. F PJ 2551 00 05	■
External dim. mm	200x140x130 h
Internal dim. mm	186x125x110 h
Capacity litres	3,6
Weight gr.	265



size 272-3A2

ORD. NO. F PJ 3351 00 01	■
ORD. NO. F PJ 3351 00 02	■
ORD. NO. F PJ 3351 00 03	■
ORD. NO. F PJ 3351 00 04	■
ORD. NO. F PJ 3351 00 05	■
External dim. mm	300x200x145 h
Internal dim. mm	284x181x130 h
Capacity litres	8,7
Weight gr.	525



size 272-4A2

ORD. NO. F PJ 5751 00 01	■
ORD. NO. F PJ 5751 00 02	■
ORD. NO. F PJ 5751 00 03	■
ORD. NO. F PJ 5751 00 04	■
ORD. NO. F PJ 5751 00 05	■
External dim. mm	450x300x120 h
Internal dim. mm	426x275x106 h
Capacity litres	16,2
Weight gr.	1000



size 272-4

ORD. NO. F PJ 6551 00 01	■
ORD. NO. F PJ 6551 00 02	■
ORD. NO. F PJ 6551 00 03	■
ORD. NO. F PJ 6551 00 04	■
ORD. NO. F PJ 6551 00 05	■
External dim. mm	450x300x200 h
Internal dim. mm	428x277x183 h
Capacity litres	27
Weight gr.	1370



size 272-4A5

ORD. NO. F PJ 7351 00 01	■
ORD. NO. F PJ 7351 00 02	■
ORD. NO. F PJ 7351 00 03	■
ORD. NO. F PJ 7351 00 04	■
ORD. NO. F PJ 7351 00 05	■
External dim. mm	450x300x300 h
Internal dim. mm	426x277x286 h
Capacity litres	40,5
Weight gr.	1865



size 272-5

ORD. NO. F PJ 8951 00 01	■
ORD. NO. F PJ 8951 00 02	■
ORD. NO. F PJ 8951 00 03	■
ORD. NO. F PJ 8951 00 04	■
ORD. NO. F PJ 8951 00 05	■
External dim. mm	630x450x300 h
Internal dim. mm	605x428x275 h
Capacity litres	85
Weight gr.	4390

GREY F.01 GREEN F.02 RED F.03 BLUE F.04 YELLOW F.05

KEY ■

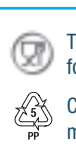
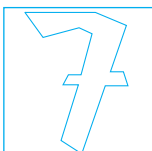

The stacking containers marked with this symbol can be used to store foodstuffs.



Containers with this symbol are made of completely recyclable plastic material.



SIZES = 01 / 0 / 1 / 2 / 3A2 / 3

SERIES STORAGE ZEUS - COMPAT



carrying handle



bar and carrying handle

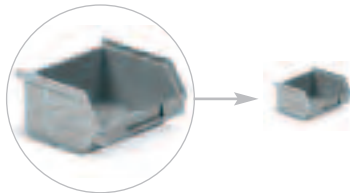

■ SHOCK RESISTANT

■ AVAILABLE IN 5 COLOURS

■ STRONG STACKING EDGES

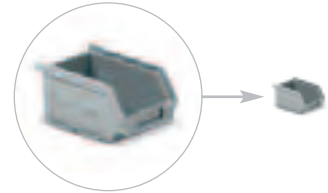

size 01

ORD. NO. F PL 0151 00 01 ■

ORD. NO. F PL 0151 00 02 ■

ORD. NO. F PL 0151 00 03 ■

ORD. NO. F PL 0151 00 04 ■

ORD. NO. F PL 0151 00 05 ■

External dim. mm 72/60x45x32 h

Internal dim. mm 55x38x32 h

Capacity litres 0,08

Weight gr. 18



size 0

ORD. NO. F PL 0951 00 01 ■

ORD. NO. F PL 0951 00 02 ■

ORD. NO. F PL 0951 00 03 ■

ORD. NO. F PL 0951 00 04 ■

ORD. NO. F PL 0951 00 05 ■

External dim. mm 85/65x95x45 h

Internal dim. mm 63x90x43 h

Capacity litres 0,25

Weight gr. 40

size 1

ORD. NO. F PM 1751 00 01 ■

ORD. NO. F PM 1751 00 02 ■

ORD. NO. F PM 1751 00 03 ■

ORD. NO. F PM 1751 00 04 ■

ORD. NO. F PM 1751 00 05 ■

External dim. mm 160/140x95x75 h

Internal dim. mm 134x88x65 h

Capacity litres 1

Weight gr. 100



size 2

ORD. NO. F PM 2551 00 01 ■

ORD. NO. F PM 2551 00 02 ■

ORD. NO. F PM 2551 00 03 ■

ORD. NO. F PM 2551 00 04 ■

ORD. NO. F PM 2551 00 05 ■

External dim. mm 230/200x140x130 h

Internal dim. mm 190x124x111 h

Capacity litres 3,8

Weight gr. 280



size 3A2

ORD. NO. F PM 3351 00 01 ■

ORD. NO. F PM 3351 00 02 ■

ORD. NO. F PM 3351 00 03 ■

ORD. NO. F PM 3351 00 04 ■

ORD. NO. F PM 3351 00 05 ■

External dim. mm 350/300x200x145 h

Internal dim. mm 285x182x130 h

Capacity litres 9,4

Weight gr. 585



size 3

ORD. NO. F PM 4151 00 01 ■

ORD. NO. F PM 4151 00 02 ■

ORD. NO. F PM 4151 00 03 ■

ORD. NO. F PM 4151 00 04 ■

ORD. NO. F PM 4151 00 05 ■

External dim. mm 350/300x200x200 h

Internal dim. mm 278x180x187 h

Capacity litres 12,5

Weight gr. 735

■ KEY

GREY
F. 01GREEN
F. 02RED
F. 03BLUE
F. 04YELLOW
F. 05

The stacking containers marked with this symbol can be used to store foodstuffs.



Containers with this symbol are made of completely recyclable plastic material.



SERIE STORAGE ZEUS - COMPAT



size 3L5

ORD. NO. F PL 4951 00 01	■
ORD. NO. F PL 4951 00 02	■
ORD. NO. F PL 4951 00 03	■
ORD. NO. F PL 4951 00 04	■
ORD. NO. F PL 4951 00 05	■

External dim. mm	350/300x450x145 h
Internal dim. mm	294x432x131 h
Capacity litres	19
Weight gr.	1060

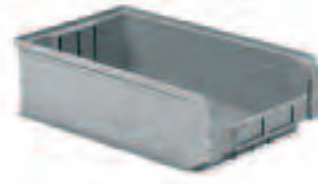

size 4A2

ORD. NO. F PM 5751 00 01	■
ORD. NO. F PM 5751 00 02	■
ORD. NO. F PM 5751 00 03	■
ORD. NO. F PM 5751 00 04	■
ORD. NO. F PM 5751 00 05	■

External dim. mm	500/450x300x145 h
Internal dim. mm	440x278x129 h
Capacity litres	20
Weight gr.	1215



size 4

ORD. NO. F PM 6551 00 01	■
ORD. NO. F PM 6551 00 02	■
ORD. NO. F PM 6551 00 03	■
ORD. NO. F PM 6551 00 04	■
ORD. NO. F PM 6551 00 05	■

External dim. mm	500/450x300x200 h
Internal dim. mm	435x281x186 h
Capacity litres	28
Weight gr.	1355



size 4A5

ORD. NO. F PM 7351 00 01	■
ORD. NO. F PM 7351 00 02	■
ORD. NO. F PM 7351 00 03	■
ORD. NO. F PM 7351 00 04	■
ORD. NO. F PM 7351 00 05	■

External dim. mm	500/450x300x300 h
Internal dim. mm	432x280x287 h
Capacity litres	42
Weight gr.	1925



size 5P4

ORD. NO. F PL 8151 00 01	■
ORD. NO. F PL 8151 00 02	■
ORD. NO. F PL 8151 00 03	■
ORD. NO. F PL 8151 00 04	■
ORD. NO. F PL 8151 00 05	■

External dim. mm	520/450x450x300 h
Internal dim. mm	431x430x277 h
Capacity litres	63
Weight gr.	3485



size 5

ORD. NO. F PL 8951 00 01	■
ORD. NO. F PL 8951 00 02	■
ORD. NO. F PL 8951 00 03	■
ORD. NO. F PL 8951 00 04	■
ORD. NO. F PL 8951 00 05	■

External dim. mm	700/630x450x300 h
Internal dim. mm	615x427x275 h
Capacity litres	88
Weight gr.	4330

GREY F.01 GREEN F.02 RED F.03 BLUE F.04 YELLOW F.05

KEY ■

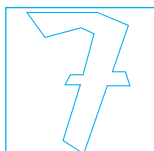

The stacking containers marked with this symbol can be used to store foodstuffs.



Containers with this symbol are made of completely recyclable plastic material.



TROUGHS



- ORD. NO. F PJ 2551 00 01
- ORD. NO. F PJ 2551 00 02
- ORD. NO. F PJ 2551 00 03
- ORD. NO. F PJ 2551 00 04
- ORD. NO. F PJ 2551 00 05

External dim. mm 200x140x130 h

No. of troughs 6 per ORD. NO. F PL 8151 00 ..
8 per ORD. NO. F PL 8951 00 ..



container ORD. NO. F PL 8951 00 04
with 8 troughs ORD. NO. F PJ 2551 00 01



container ORD. NO. F PL 8151 00 03
with 6 troughs ORD. NO. F PJ 2551 00 05

TROUGHS WITH 2/4 COMPARTMENTS FOR CONTAINERS SERIES F PM



■ 01

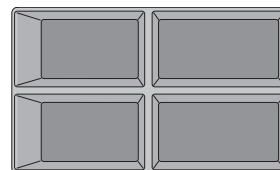

■ 01

Troughs with 2 compartments

ORD. NO.

F PP 0551 00 01

External dim. mm 150/120x90x35 h

No. of troughs 2

For containers ORD. NO. F PM 1751 00 ..



container ORD. NO. F PM 2551 00 04
with 1 trough ORD. NO. F PP 1551 00 01

Troughs with 4 compartments

ORD. NO.

F PP 1051 00 01

External dim. mm 150/120x90x35 h

No. of troughs 4

For containers ORD. NO. F PM 1751 00 ..

ORD. NO.

F PP 1551 00 01

External dim. mm 205/160x125x60 h

No. of troughs 2

For containers ORD. NO. F PM 2551 00 ..



container ORD. NO. F PM 2551 00 03
with 1 trough ORD. NO. F PP 2051 00 01

ORD. NO.

F PP 2051 00 01

External dim. mm 205/160x125x60 h

No. of troughs 4

For containers ORD. NO. F PM 2551 00 ..

KEY

GREY
F.01

GREEN
F.02

RED
F.03

BLUE
F.04

YELLOW
F.05



The stacking containers marked with this symbol can be used to store foodstuffs.



Containers with this symbol are made of completely recyclable plastic material.



SERIES STORAGE ZEUS – COMPAT

FRONT TO BACK METAL DIVIDER FOR CONTAINERS SERIES F PL – F PM

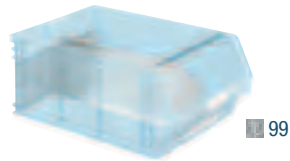

■ 99

Front to back metal divider with pair of supports

ORD. NO. F ND 0211 01 99

For containers ORD. NO. F PL 8151 00 ..

ORD. NO. F ND 0231 01 99

For containers ORD. NO. F PL 8951 00 ..



Supplementary front to back divider

ORD. NO. F ND 0211 00 99

For containers ORD. NO. F PL 8151 00 ..

ORD. NO. F ND 0231 00 99

For containers ORD. NO. F PL 8951 00 ..



■ 99

Front to back metal divider

ORD. NO. F ND 0110 00 99

For containers ORD. NO. F PM 3351 00 ..

ORD. NO. F ND 0140 00 99

For containers ORD. NO. F PM 4151 00 ..

ORD. NO. F ND 0150 00 99

For containers ORD. NO. F PL 4951 00 ..

ORD. NO. F ND 0160 00 99

For containers ORD. NO. F PM 5751 00 ..

ORD. NO. F ND 0180 00 99

For containers ORD. NO. F PM 6551 00 ..

ORD. NO. F ND 0170 00 99

For containers ORD. NO. F PM 7351 00 ..

SUB-DIVIDERS FOR CONTAINERS SERIES F PM



Sub-divider

ORD. NO. F ND 1110 00 99

For containers ORD. NO. F PM 6551 00 ..

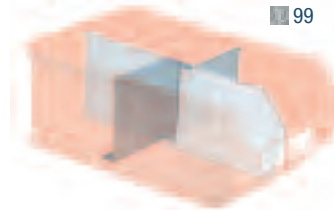

■ 99

FRONT TO BACK PLASTIC DIVIDER FOR CONTAINERS SERIES F PL – F PM

Front to back plastic divider

ORD. NO. F PZ 1071 00 07

For containers ORD. NO. F PM 3351 00 ..

ORD. NO. F PZ 1571 00 07

For containers ORD. NO. F PM 4151 00 ..

ORD. NO. F PZ 2071 00 07

For containers ORD. NO. F PL 4951 00 ..

ORD. NO. F PZ 2571 00 07

For containers ORD. NO. F PM 6551 00 ..

ORD. NO. F PZ 3071 00 07

For containers ORD. NO. F PM 7351 00 ..

■ 07

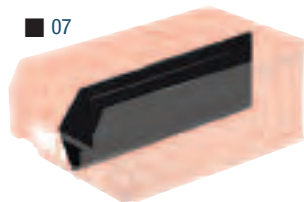

GUARANTEE
5
YEARS



■ GALVANISED
F.....99

■ BLACK
F.....07

INFO ■

www.famispa.com





■ 99

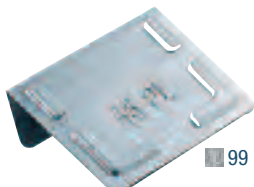

■ 99

ORD. NO. F ND 2110 00 99

ORD. NO. F ND 2130 00 99

INCLINED LABEL HOLDER

ORD. NO.

**FOR CONTAINERS
ORD. NO.**

F ND 2110 00 99

F PM 3351 00 ..
F PM 4151 00 ..
F PM 4251 00 ..
F PM 6551 00 ..
F PM 6651 00 ..
F PM 7351 00 ..
F PM 7451 00 ..

F ND 2130 00 99

F PL 8151 00 ..
F PL 8951 00 ..

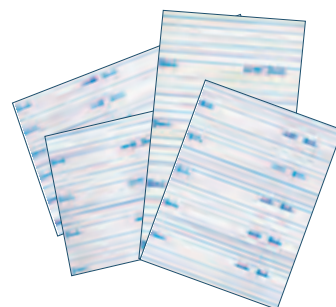

**LABELS FOR STACKING
AND STORAGE CONTAINERS**

ORD. NO.

**FOR CONTAINERS
ORD. NO.**

**DIM. OF SINGLE
LABEL mm**

**NO. OF LABELS
PER SHEET**

F PL 9020 00 00	F PL 0951 00 ..	49x11	80
F PL 9040 00 00	F PM 1751 00 ..	75x20	36
F PL 9100 00 00	F PM 2551 00 ..	104x33	16
F PL 9060 00 00	F PM 3351 00 .. F PL 4951 00 .. F PM 5751 00 ..	77x31	18
F PL 9080 00 00	F PM 4151 00 .. F PM 4251 00 .. F PM 6551 00 .. F PM 6651 00 .. F PM 7351 00 .. F PM 7451 00 ..	77x42	12
F PL 9120 00 00	F PL 8151 00 .. F PL 8951 00 ..	127x39	10
F PL 9160 00 00	F PL 8151 00 .. F PL 8951 00 .. F PJ 6551 00 .. F PJ 7351 00 .. F PJ 8951 00 ..	189x85	3
F PL 9140 00 00	F PJ 5751 00 ..	189x82	3

PERSONALISED LOGOS



injection logo

hot printed logo

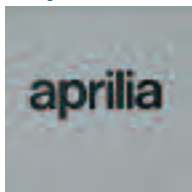

DUST COVER FOR CONTAINERS SERIES F PM



ORD. NO. F PZ 5668 00 96

ORD. NO. F PZ 5368 00 96

ORD. NO. F PZ 6568 00 96

ORD. NO. F PZ 6268 00 96



ORD. NO.

**FOR CONTAINERS
ORD. NO.**

F PZ 5668 00 96	F PM 3351 00 ..
F PZ 5368 00 96	F PM 4151 00 .. / F PM 4251 00 ..
F PZ 6568 00 96	F PM 6551 00 .. / F PM 6651 00 ..
F PZ 6268 00 96	F PM 7351 00 .. / F PM 7451 00 ..

■ INFO

GALVANISED
F.....99

TRANSPARENT
F.....96



www.famispa.com



SERIES STORAGE STEEL

- 90° BLOCK HANDLE
- AVAILABLE IN 2 COLOURS AND GALVANISED
- EASY CARRIAGE WITH TROLLEYS



90° block handle



Painted stacking container

TROLLEYS FOR LIFTING AND TRANSPORTING METAL STACKING CONTAINERS SERIES F LA

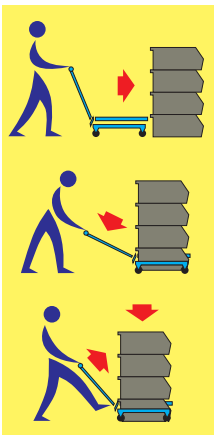

how to use the lifting trolley



■ N.B. Also plastic containers can be carried with this trolley but the first forked container must be of steel.



ORD. NO.	LOAD CAPACITY kg
F CR 0401 00 04	300
Trolley for stacking and storage containers	
ORD. NO. F LS 6500 00 .. / ORD. NO. F LA 6520 00 ..	
2 rubber swivel wheels Ø 125 mm	
2 polyurethane fixed wheels Ø 125 mm	

ORD. NO.	LOAD CAPACITY kg
F CR 0421 00 04	300
Trolley for stacking and storage containers ORD. NO. F LS 8900 00 ..	
ORD. NO. F LS 8100 00 .. / ORD. NO. F LA 8920 00 ..	
2 rubber swivel wheels Ø 125 mm	
2 polyurethane fixed wheels Ø 125 mm	

RAL 5012
F.....04

RAL 7000
F.....01

Hot GALVANISED
F.....99

INFO ■



METAL STACKING CONTAINERS

SERIES STORAGE STEEL



size 272-3A2

- ORD. NO. F LA 3320 00 01 ■
- ORD. NO. F LA 3320 00 02 ■
- ORD. NO. F LA 3320 00 99 ■

External dim. mm	300x200x145 h
Internal dim. mm	290x183x132 h
Capacity litres	8,7



size 272-3

- ORD. NO. F LA 4120 00 01 ■
- ORD. NO. F LA 4120 00 02 ■
- ORD. NO. F LA 4120 00 99 ■

External dim. mm	300x200x200 h
Internal dim. mm	290x186x184 h
Capacity litres	12



size 272-4

- ORD. NO. F LA 6520 00 01 ■
- ORD. NO. F LA 6520 00 02 ■
- ORD. NO. F LA 6520 00 99 ■

External dim. mm	450x300x200 h
Internal dim. mm	442x285x182 h
Capacity litres	27



size 272-4A5

- ORD. NO. F LA 7320 00 01 ■
- ORD. NO. F LA 7320 00 02 ■
- ORD. NO. F LA 7320 00 99 ■

External dim. mm	450x300x300 h
Internal dim. mm	440x280x278 h
Capacity litres	40,5



size 272-5

- ORD. NO. F LA 8920 00 01 ■
- ORD. NO. F LA 8920 00 02 ■
- ORD. NO. F LA 8920 00 99 ■

External dim. mm	630x450x300 h
Internal dim. mm	617x430x278 h
Capacity litres	85

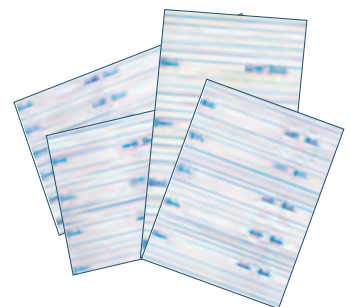

LABEL FOR CONTAINERS

ORD. NO.	FOR STACKING AND STORAGE CONTAINERS ORD. NO.	DIM. SINGLE LABEL mm	NO. LABELS PER SHEET
F LS 9040 00 00	F LA 3320 00 ..	73x37	15
F LS 9060 00 00	F LA 4120 00 .. F LA 6520 00 ..	80x48	12
F LS 9080 00 00	F LA 7320 00 .. F LA 8920 00 ..	102x76	6

INFO

RAL 6011
F.02

RAL 7000
F.01

Hot GALVANISED
F.99



www.famispa.com

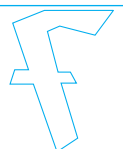

SERIES STORAGE STEEL

- 90° BLOCK HANDLE
- IDEAL FOR MATERIAL WASH
- HOLES IN 6 DIFFERENT SIZES
- STAINLESS STEEL AND HEAT GALVANISED



The FAMI perforated stacking containers have been produced to satisfy the requirements to wash the contents without removing. Thanks to this special feature, they are used a lot in processes such as degreasing components directed towards the assembly shop where the washing liquid must be eliminated. They also allow the contents to be aerated if required.

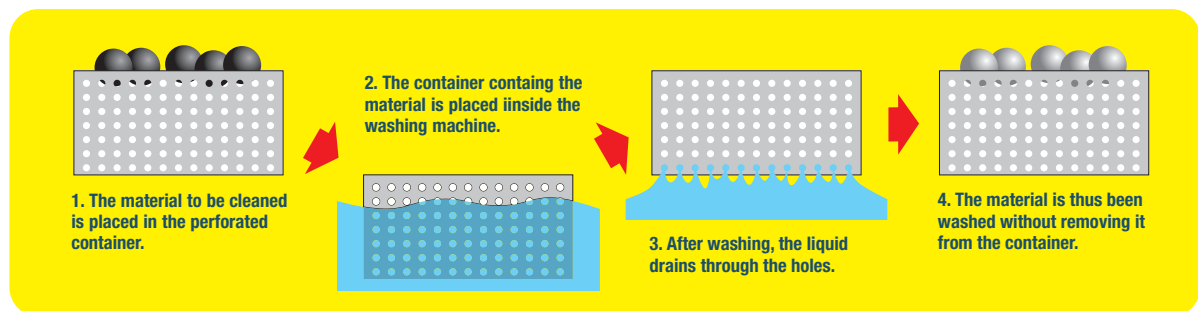
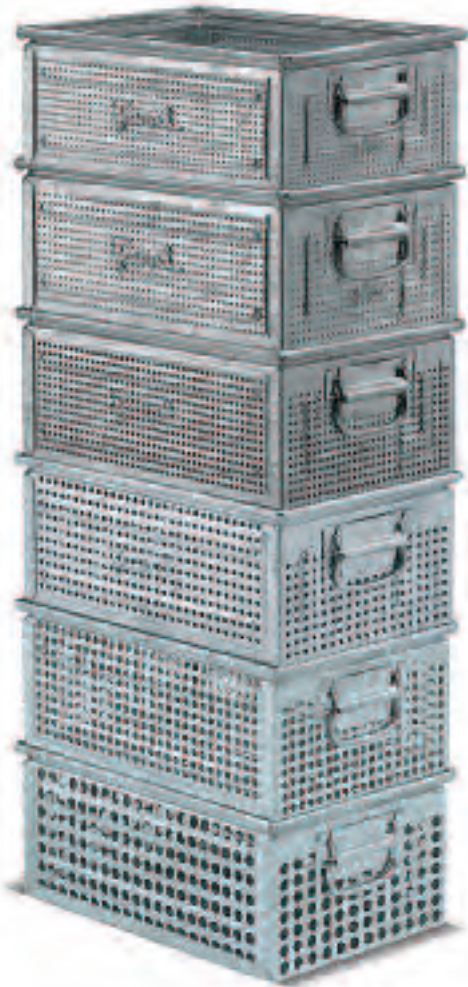

STEEL
F...ZZ

Hot GALVANISED
F...99

INFO ■

www.famispa.com





hole Ø 3 mm

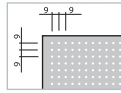

size 272-4

ORD. NO. F LA 6510 00 ZZ ■

External dim. mm 450x300x200 h

Internal dim. mm 442x285x182 h

Capacity litres 27



hole Ø 4,2 mm

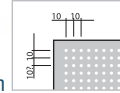

size 272-4

ORD. NO. F LA 6511 00 99 ■

External dim. mm 450x300x200 h

Internal dim. mm 442x285x182 h

Capacity litres 27



hole Ø 5,5 mm

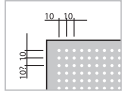

size 272-4

ORD. NO. F LA 6512 00 99 ■

External dim. mm 450x300x200 h

Internal dim. mm 442x285x182 h

Capacity litres 27



hole Ø 7 mm

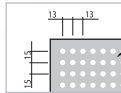

size 272-4

ORD. NO. F LA 6513 00 99 ■

External dim. mm 450x300x200 h

Internal dim. mm 442x285x182 h

Capacity litres 27



hole Ø 10 mm

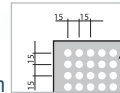

size 272-4

ORD. NO. F LA 6515 00 99 ■

External dim. mm 450x300x200 h

Internal dim. mm 442x285x182 h

Capacity litres 27



hole Ø 15 mm

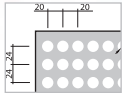

size 272-4

ORD. NO. F LA 6517 00 99 ■

External dim. mm 450x300x200 h

Internal dim. mm 442x285x182 h

Capacity litres 27

■ INFO

STEEL
F.ZZ

Hot GALVANISED
F.99



www.famispa.com

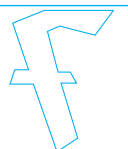

SERIES STORAGE STEEL

- 90° BLOCK HANDLE
- SEVERAL TYPES FOR DIFFERENT NEEDS
- MADE OF PAINTED OR GALVANISED STEEL
- THE FRONT OPENING MAKES THE PICKING OF TO CONTENT EASY



STORAGE CONTAINERS WITH SPECIAL APPLICATIONS

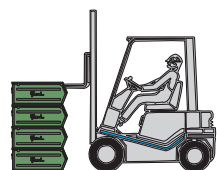

lifting system with fork lift truck



lifting system with fork lift truck

RAL 6011
F.....02RAL 7000
F.....01Hot GALVANISED
F.....99

INFO ■

www.famispa.com

METAL STORAGE CONTAINERS

SERIES STORAGE STEEL



lift bar coupled with
the 90° block handle



size 1

ORD. NO. F LS 1700 00 01 ■

ORD. NO. F LS 1700 00 02 ■

ORD. NO. F LS 1700 00 99 ■

External dim. mm 160/140x95x75 h

Internal dim. mm 138x86x66 h

Capacity litres 1

Without 90° block handle



size 2

ORD. NO. F LS 2500 00 01 ■

ORD. NO. F LS 2500 00 02 ■

ORD. NO. F LS 2500 00 99 ■

External dim. mm 230/200x140x130 h

Internal dim. mm 196x131x113 h

Capacity litres 3,8

Without 90° block handle

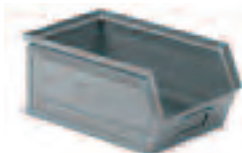

size 3A2

ORD. NO. F LS 3300 00 01 ■

ORD. NO. F LS 3300 00 02 ■

ORD. NO. F LS 3300 00 99 ■

External dim. mm 350/300x200x145 h

Internal dim. mm 298x181x135 h

Capacity litres 9,4

Without 90° block handle



size 3

ORD. NO. F LS 4100 00 01 ■

ORD. NO. F LS 4100 00 02 ■

ORD. NO. F LS 4100 00 99 ■

External dim. mm 350/300x200x200 h

Internal dim. mm 300x185x184 h

Capacity litres 12,5

With 90° block handle



size 3P4

ORD. NO. F LS 4900 00 01 ■

ORD. NO. F LS 4900 00 02 ■

ORD. NO. F LS 4900 00 99 ■

External dim. mm 500/450x200x200 h

Internal dim. mm 448x184x184 h

Capacity litres 18

With 90° block handle



size 4A2

ORD. NO. F LS 5700 00 01 ■

ORD. NO. F LS 5700 00 02 ■

ORD. NO. F LS 5700 00 99 ■

External dim. mm 500/450x300x145 h

Internal dim. mm 448x281x135 h

Capacity litres 20

Without 90° block handle



size 4

ORD. NO. F LS 6500 00 01 ■

ORD. NO. F LS 6500 00 02 ■

ORD. NO. F LS 6500 00 99 ■

External dim. mm 500/450x300x200 h

Internal dim. mm 448x284x185 h

Capacity litres 28

With 90° block handle



size 4A5

ORD. NO. F LS 7300 00 01 ■

ORD. NO. F LS 7300 00 02 ■

ORD. NO. F LS 7300 00 99 ■

External dim. mm 520/450x300x300 h

Internal dim. mm 446x288x278 h

Capacity litres 42

With 90° block handle



size 5P4

ORD. NO. F LS 8100 00 01 ■

ORD. NO. F LS 8100 00 02 ■

ORD. NO. F LS 8100 00 99 ■

External dim. mm 520/450x450x300 h

Internal dim. mm 448x428x278 h

Capacity litres 63

With 90° block handle



size 5

ORD. NO. F LS 8900 00 01 ■

ORD. NO. F LS 8900 00 02 ■

ORD. NO. F LS 8900 00 99 ■

External dim. mm 700/630x450x300 h

Internal dim. mm 630x428x278 h

Capacity litres 88

With 90° block handle

■ INFO

RAL 6011
F.02

RAL 7000
F.01

Hot GALVANISED
F.99



www.famispa.com



SERIES STORAGE STEEL

STORAGE CONTAINERS WITH DOUBLE CARRYING BARS



size 4

ORD. NO. F LS 6501 00 01 ■

ORD. NO. F LS 6501 00 02 ■

ORD. NO. F LS 6501 00 99 ■

External dim. mm 500/450x300x200 h

Internal dim. mm 448x284x185 h

Capacity litres 28

With 90° block handle



size 4A5

ORD. NO. F LS 7301 00 01 ■

ORD. NO. F LS 7301 00 02 ■

ORD. NO. F LS 7301 00 99 ■

External dim. mm 520/450x300x300 h

Internal dim. mm 446x288x278 h

Capacity litres 42

With 90° block handle



size 5P4

ORD. NO. F LS 8101 00 01 ■

ORD. NO. F LS 8101 00 02 ■

ORD. NO. F LS 8101 00 99 ■

External dim. mm 520/450x450x300 h

Internal dim. mm 448x428x278 h

Capacity litres 63

With 90° block handle



size 5

ORD. NO. F LS 8901 00 01 ■

ORD. NO. F LS 8901 00 02 ■

ORD. NO. F LS 8901 00 99 ■

External dim. mm 700/630x450x300 h

Internal dim. mm 630x428x278 h

Capacity litres 88

With 90° block handle

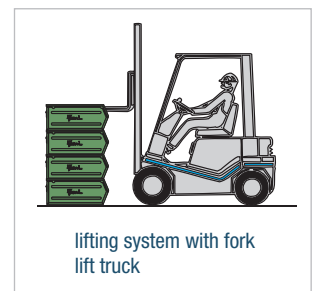

STORAGE CONTAINERS WITH SLIDING BASE



size 5P4

ORD. NO. F LS 8110 00 01 ■

ORD. NO. F LS 8110 00 02 ■

ORD. NO. F LS 8110 00 99 ■

External dim. mm 520/450x450x390 h

Internal dim. mm 448x428x278 h

Capacity litres 63

With 90° block handle



size 5

ORD. NO. F LS 8910 00 01 ■

ORD. NO. F LS 8910 00 02 ■

ORD. NO. F LS 8910 00 99 ■

External dim. mm 700/630x450x390 h

Internal dim. mm 630x428x278 h

Capacity litres 88

With 90° block handle

RAL 6011
F.02RAL 7000
F.01Hot GALVANISED
F.99

INFO ■

www.famispa.com

LABELS / FRONT TO BACK METAL DIVIDERS

SERIES STORAGE STEEL

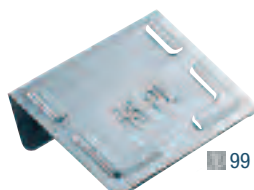

ORD. NO. F ND 2120 00 99

ORD. NO. F ND 2110 00 99

INCLINED LABEL HOLDER

ORD. NO.	FOR CONTAINERS ORD. NO.
F ND 2120 00 99	F LS 7300 00 ..
	F LS 7301 00 ..
	F LS 8100 00 ..
	F LS 8101 00 ..
	F LS 8110 00 ..
	F LS 8900 00 ..
	F LS 8901 00 ..
F ND 2110 00 99	F LS 4100 00 ..
	F LS 6500 00 ..
	F LS 6501 00 ..



LABEL FOR METAL STORAGE CONTAINERS

ORD. NO.	FOR STORAGE CONTAINERS ORD. NO.	DIM. SINGLE LABEL mm	NO. LABELS PER SHEET
F LS 9020 00 00	F LS 1700 00 ..	47x17	60
	F LS 2500 00 ..		
F LS 9040 00 00	F LS 3300 00 ..	73x37	15
	F LS 5700 00 ..		
	F LS 4100 00 ..		
F LS 9060 00 00	F LS 4900 00 ..	80x48	12
	F LS 6500 00 ..		
	F LS 6501 00 ..		
	F LS 7300 00 ..		
F LS 9080 00 00	F LS 7301 00 ..	102x76	6
	F LS 8900 00 ..		
	F LS 8901 00 ..		
	F LS 8910 00 ..		
	F LS 8100 00 ..		
	F LS 8101 00 ..		
	F LS 8110 00 ..		
	F LS 8110 00 ..		

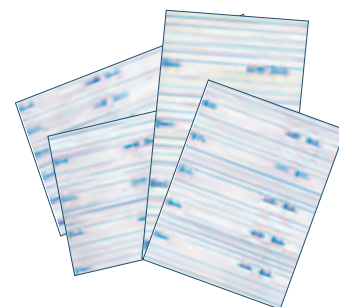

FRONT TO BACK METAL DIVIDERS

■ 99

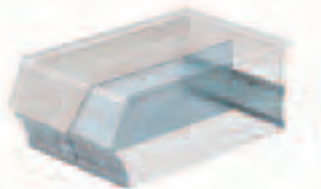

Front to back metal dividers with pair of supports

ORD. NO. F ND 0130 01 99	
For containers ORD. NO.	F LS 4100 00 ..
ORD. NO. F ND 0190 01 99	
For containers ORD. NO.	F LS 6500 00 .. F LS 6501 00 ..
ORD. NO. F ND 0221 01 99	
For containers ORD. NO.	F LS 7300 00 .. F LS 7301 00 ..
ORD. NO. F ND 0221 02 99	
For containers ORD. NO.	F LS 8100 00 .. F LS 8101 00 .. F LS 8110 00 ..
ORD. NO. F ND 0241 01 99	
For containers ORD. NO.	F LS 8900 00 .. F LS 8901 00 .. F LS 8910 00 ..

Additional front to back metal divider

ORD. NO. F ND 0130 00 99	
For containers ORD. NO.	F LS 4100 00 ..
ORD. NO. F ND 0190 00 99	
For containers ORD. NO.	F LS 6500 00 .. F LS 6501 00 ..
ORD. NO. F ND 0221 00 99	
For containers ORD. NO.	F LS 7300 00 .. F LS 7301 00 .. F LS 8100 00 .. F LS 8101 00 .. F LS 8110 00 ..
ORD. NO. F ND 0241 00 99	
For containers ORD. NO.	F LS 8900 00 .. F LS 8901 00 .. F LS 8910 00 ..



■ INFO

■ RAL 6011
F.02

■ RAL 7000
F.01

■ Hot GALVANISED
F.99



www.famispa.com



SERIES STORAGE MULTIBOX

- SHOCK RESISTANT WALLS
- AVAILABLE IN 10 DIFFERENT SIZES

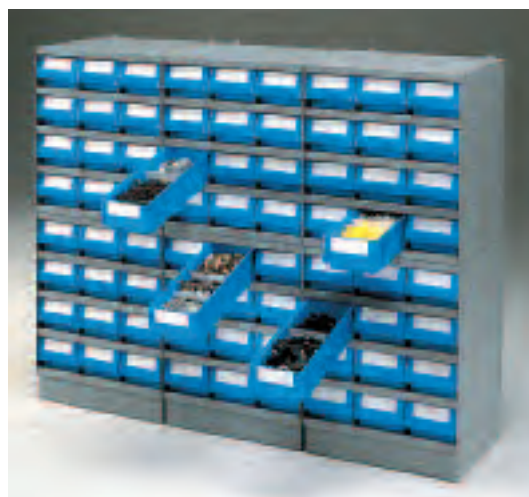

Stacking housings for Multibox boxes



The galvanised steel safety guard prevents the boxes from accidentally falling out of the stacking housings.



Transparent polystyrene dividers and labels available.



A special handle, supplied on request, makes it easy to lift and carry the Multibox series F PK boxes.



BLUE
F.....04

KEY ■

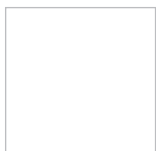
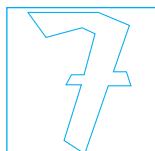

Containers with this symbol are made of completely recyclable plastic material.



MULTIBOX BOXES

SERIES STORAGE MULTIBOX

■ 04



ORD. NO.	DIM. mm
F PK 0551 00 04	300x120x100 h
External dim. mm	300x120x100 h
Internal dim. mm	255x94x89 h
Max q.ty of transversal dividers which can be inserted	4 pcs ORD. NO. F PK 7068 00 96

■ 04



ORD. NO.	DIM. mm
F PK 1551 00 04	400x120x100 h
External dim. mm	400x120x100 h
Internal dim. mm	358x98x89 h
Max q.ty of transversal dividers which can be inserted	6 pcs ORD. NO. F PK 7068 00 96

■ 04



ORD. NO.	DIM. mm
F PK 3051 00 04	500x120x100 h
External dim. mm	500x120x100 h
Internal dim. mm	460x94x89 h
Max q.ty of transversal dividers which can be inserted	8 pcs ORD. NO. F PK 7068 00 96

■ 04



ORD. NO.	DIM. mm
F PK 1051 00 04	300x160x100 h
External dim. mm	300x160x100 h
Internal dim. mm	260x135x89 h
Max q.ty of transversal dividers which can be inserted	4 pcs ORD. NO. F PK 7368 00 96

■ 04



ORD. NO.	DIM. mm
F PK 2051 00 04	400x160x100 h
External dim. mm	400x160x100 h
Internal dim. mm	358x135x90 h
Max q.ty of transversal dividers which can be inserted	6 pcs ORD. NO. F PK 7368 00 96

■ 04



ORD. NO.	DIM. mm
F PK 3551 00 04	500x160x100 h
External dim. mm	500x160x100 h
Internal dim. mm	460x135x89 h
Max q.ty of transversal dividers which can be inserted	8 pcs ORD. NO. F PK 7368 00 96

■ 04



ORD. NO.	DIM. mm
F PK 4551 00 04	600x160x100 h
External dim. mm	600x160x100 h
Internal dim. mm	560x135x90 h
Max q.ty of transversal dividers which can be inserted	10 pcs ORD. NO. F PK 7368 00 96

■ 04



ORD. NO.	DIM. mm
F PK 2551 00 04	400x240x100 h
External dim. mm	400x240x100 h
Internal dim. mm	358x215x89 h
Max q.ty of transversal dividers which can be inserted	6 pcs ORD. NO. F PK 7668 00 96

■ 04



ORD. NO.	DIM. mm
F PK 4051 00 04	500x240x100 h
External dim. mm	500x240x100 h
Internal dim. mm	462x214x89 h
Max q.ty of transversal dividers which can be inserted	8 pcs ORD. NO. F PK 7668 00 96

NEW

■ 04



ORD. NO.	DIM. mm
F PK 2751 00 04	435x140x80 h
External dim. mm	435x140x80 h
Internal dim. mm	420/405x125x70 h
Max q.ty of transversal dividers which can be inserted	7 pcs ORD. NO. F PK 7268 00 96



■ KEY

BLUE
F.....04

Containers with this symbol are made of completely recyclable plastic material.



SERIES STORAGE MULTIBOX

HANDLE

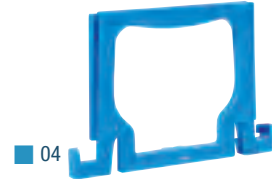

ORD. NO.	DIM. mm
F PK 6351 00 04	120x80 h
For boxes ORD. NO.	F PK 1051 00 04 F PK 2051 00 04 F PK 3551 00 04 F PK 4551 00 04

ORD. NO.	DIM. mm
F PK 6051 00 04	70x90 h
For boxes ORD. NO.	F PK 0551 00 04 F PK 1551 00 04 F PK 3051 00 04

ORD. NO.	DIM. mm
F PK 6651 00 04	110x90 h
For boxes ORD. NO.	F PK 2551 00 04 F PK 4051 00 04



fitting handle
F PK 6351 00 04

fitting handle
F PK 6051 00 04, F PK 6651 00 04

SAFETY GUARDS ■ 99

ORD. NO.	Ø mm
F PK 9410 00 99	3
For boxes ORD. NO.	F PK 0551 00 04 F PK 1551 00 04 F PK 3051 00 04

ORD. NO.	Ø mm
F PK 9420 00 99	3
For boxes ORD. NO.	F PK 1051 00 04 F PK 2051 00 04 F PK 3551 00 04 F PK 4551 00 04 F PK 2551 00 04 F PK 4051 00 04

The safety guards prevent the boxes from falling out by accident



FRONT TO BACK DIVIDERS



ORD. NO.	DIM. mm	FOR BOXES ORD. NO.
F PK 9230 00 99	268x88 h	F PK 0551 00 04 F PK 1051 00 04
F PK 9240 00 00	368x88 h	F PK 1551 00 04 F PK 2051 00 04 F PK 2551 00 04

ORD. NO.	DIM. mm	FOR BOXES ORD. NO.
F PK 9250 00 00	468x88 h	F PK 3051 00 04 F PK 3551 00 04 F PK 4051 00 04
F PK 9260 00 00	568x88 h	F PK 4551 00 04

■ BLUE
F.....04

■ GALVANISED
F.....99

KEY ■



Handles with this symbol are made of completely recyclable plastic material.

TRANSVERSAL DIVIDERS



96



ORD. NO.	DIM. mm
F PK 7068 00 96	100x90 h

For boxes ORD. NO. F PK 0551 00 04
F PK 1551 00 04
F PK 3051 00 04

96



ORD. NO.	DIM. mm
F PK 7368 00 96	145x90 h

For boxes ORD. NO. F PK 1051 00 04
F PK 2051 00 04
F PK 3551 00 04
F PK 4551 00 04

96



ORD. NO.	DIM. mm
F PK 7668 00 96	225x90 h

For boxes ORD. NO. F PK 2551 00 04
F PK 4051 00 04

96



ORD. NO.	DIM. mm
F PK 7268 00 96	137x75 h

For boxes ORD. NO. F PK 2751 00 04



LABELS FOR BOXES

ORD. NO.	FOR BOXES ORD. NO.	DIM. SINGLE LABEL mm	NO. LABELS PER SHEET
F PK 9540 00 00	F PK 0551 00 04	81x42	12
	F PK 1551 00 04		
	F PK 3051 00 04		
F PK 9580 00 00	F PK 1051 00 04	121x44	8
	F PK 2051 00 04		
	F PK 3551 00 04		
	F PK 4551 00 04		
	F PK 2751 00 04		
F PK 9600 00 00	F PK 2551 00 04	200x43	6
	F PK 4051 00 04		

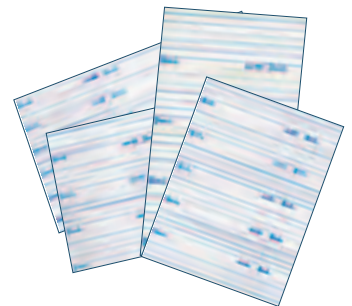

LABELS FOR DIVIDERS

ORD. NO.	FOR BOXES ORD. NO.	DIM. SINGLE LABEL mm	NO. LABELS PER SHEET
F PK 9520 00 00	F PK 7068 00 96	80x24	24
	F PK 7268 00 96		
F PK 9560 00 00	F PK 7368 00 96	121x24	16
	F PK 7668 00 96		



KEY



Dividers with this symbol are made of completely recyclable plastic material.

TRANSPARENT
F. 99

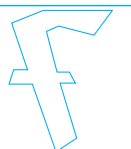

SERIES STORAGE MULTIBOX

STACKING HOUSINGS FOR MULTIBOX BOXES



Stacking housings with tabs for fixing the containers mounted one on the top of the other. The stacking housing must be fitted to the wall with 2 Ø 8 mm screws.

F PK 9030 00 01



■ 01

F PK 9040 00 01



■ 01

F PK 9050 00 01

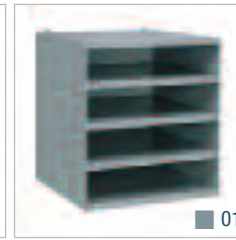

■ 01

F PK 9060 00 01

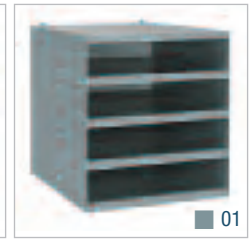

■ 01

STACKING HOUSING WITHOUT
MULTIBOX

F PK 9030 00 01

DIM. 500x300x545 mm h

F PK 9040 00 01

DIM. 500x400x545 mm h

F PK 9050 00 01

DIM. 500x500x545 mm h

F PK 9060 00 01

DIM. 500x600x545 mm h

STACKING HOUSING WITH
MULTIBOX

F PK 9030 01 01*

F PK 9030 02 01*

F PK 9030 03 01*

F PK 9040 01 01*

F PK 9040 02 01*

F PK 9040 03 01*

F PK 9040 04 01*

F PK 9040 05 01*

F PK 9040 06 01*

F PK 9040 07 01*

F PK 9050 01 01*

F PK 9050 02 01*

F PK 9050 03 01*

F PK 9050 04 01*

F PK 9050 05 01*

F PK 9050 06 01*

F PK 9050 07 01*

F PK 9060 02 01*

NO. MULTIBOX
INSERTED

16 pcs ORD. NO. F PK 0551 00 04

12 pcs ORD. NO. F PK 1051 00 04

8 pcs ORD. NO. F PK 0551 00 04

6 pcs ORD. NO. F PK 1051 00 04

16 pcs ORD. NO. F PK 1551 00 04

12 pcs ORD. NO. F PK 2051 00 04

8 pcs ORD. NO. F PK 1551 00 04

6 pcs ORD. NO. F PK 2051 00 04

8 pcs ORD. NO. F PK 2551 00 04

8 pcs ORD. NO. F PK 1551 00 04

4 pcs ORD. NO. F PK 2551 00 04

6 pcs ORD. NO. F PK 2051 00 04

4 pcs ORD. NO. F PK 2551 00 04

4 pcs ORD. NO. F PK 1551 00 04

6 pcs ORD. NO. F PK 2051 00 04

2 pcs ORD. NO. F PK 2551 00 04

16 pcs ORD. NO. F PK 3051 00 04

12 pcs ORD. NO. F PK 3551 00 04

8 pcs ORD. NO. F PK 3051 00 04

6 pcs ORD. NO. F PK 3551 00 04

8 pcs ORD. NO. F PK 4051 00 04

8 pcs ORD. NO. F PK 3051 00 04

4 pcs ORD. NO. F PK 4051 00 04

6 pcs ORD. NO. F PK 3551 00 04

4 pcs ORD. NO. F PK 4051 00 04

4 pcs ORD. NO. F PK 3051 00 04

6 pcs ORD. NO. F PK 3551 00 04

2 pcs ORD. NO. F PK 4051 00 04

12 pcs ORD. NO. F PK 4551 00 04

*Including guide rails and safety guards for boxes

F PK 9030 01 01
F PK 9040 01 01
F PK 9050 01 01F PK 9030 02 01
F PK 9040 02 01
F PK 9050 02 01
F PK 9060 02 01F PK 9030 03 01
F PK 9040 03 01
F PK 9050 03 01F PK 9040 04 01
F PK 9050 04 01F PK 9040 05 01
F PK 9050 05 01F PK 9040 06 01
F PK 9050 06 01F PK 9040 07 01
F PK 9050 07 01RAL 7000
F.....01

INFO ■

www.famispa.com



SERIES STORAGE MULTIBOX

BASE PLINTHS

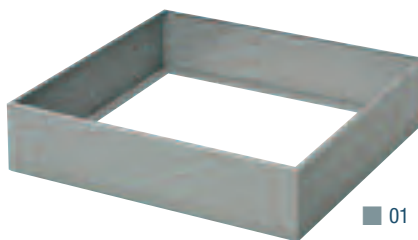
ORD. NO.	DIM. mm	FOR STACK. HOUSING ORD. NO.
F PK 9135 00 01	485x275x90 h	F PK 9030 00 01
F PK 9145 00 01	485x375x90 h	F PK 9040 00 01
F PK 9155 00 01	485x475x90 h	F PK 9050 00 01
F PK 9165 00 01	485x575x90 h	F PK 9060 00 01

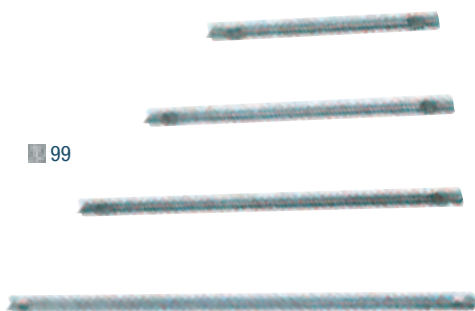

fitting the base plinth



GUIDES

ORD. NO.	FOR STACKING HOUSING ORD. NO.
F ST 9830 00 99	F PK 9030 00 01
F ST 9840 00 99	F PK 9040 00 01
F ST 9850 00 99	F PK 9050 00 01
F ST 9860 00 99	F PK 9060 00 01

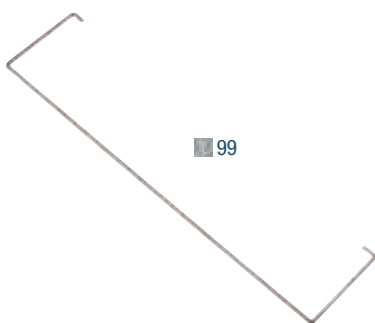

SAFETY GUARDS FOR STACKING HOUSING

ORD. NO.	FOR STACKING HOUSING ORD. NO.
F PK 9360 00 99	F PK 9030 00 01
	F PK 9040 00 01
	F PK 9050 00 01
	F PK 9060 00 01

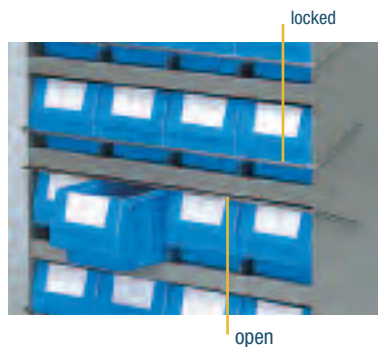

■ INFO

GALVANISED
F.....99

RAL 7000
F.....01



www.famispa.com



SERIES STORAGE PRACTIBOX

- ABS STRUCTURE
- TRANSPARENT POLYSTYRENE COMPARTMENTS WITH HIGH MECHANICAL RESISTANCE
- EASY COMPARTMENTS FRONT OPENING

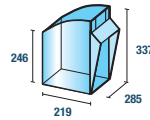
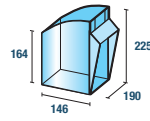
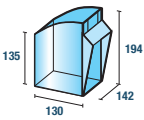
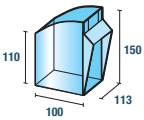
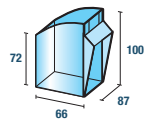
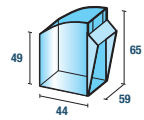

Top-box case

- FOR THE COMPARTMENTS CLEANING THE USE OF SOLVENTS IS NOT SUGGESTED



Vertical system



Container trolley



Rotary tower

COLOUR OF CONTAINERS
RAL 7000 F.01

COLOUR OF COMPARTMENTS
TRANSPARENT F.96

INFO ■

www.famispa.com

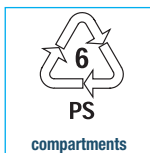
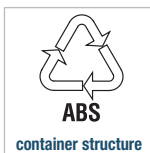
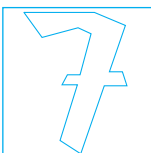

LENGTH = 600 mm

SERIES STORAGE PRACTIBOX

SINGLE CONTAINERS



■ 96 - compartments ■ 01 - containers

ORD. NO.	DIM. mm
F PG 1071 01 01	600x69x77 h
Container with 9 compartments	



■ 96 - compartments ■ 01 - containers

ORD. NO.	DIM. mm
F PG 1571 01 01	600x98x112 h
Container with 6 compartments	



■ 96 - compartments ■ 01 - containers

ORD. NO.	DIM. mm
F PG 2071 01 01	600x141x164 h
Container with 5 compartments	



■ 96 - compartments ■ 01 - containers

ORD. NO.	DIM. mm
F PG 2571 01 01	600x174x206 h
Container with 4 compartments	



■ 96 - compartments ■ 01 - containers

ORD. NO.	DIM. mm
F PG 3071 01 01	600x209x240 h
Container with 3 compartments	



■ 96 - compartments ■ 01 - containers

ORD. NO.	DIM. mm
F PG 3571 01 01	600x311x353 h
Container with 2 compartments	

BENCH DISPENSER



■ 01

ORD. NO.	DIM. mm
F PG 0320 00 01	610x150x500 h
Realized in steel	



■ 96 - compartments ■ 01 - containers

ORD. NO.	DIM. mm
F PG 0320 01 01	610x189,5x500 h
Including practibox containers	1 ORD. NO. F PG 1571 01 01 1 ORD. NO. F PG 2071 01 01 1 ORD. NO. F PG 2571 01 01



■ INFO

COLOUR OF CONTAINERS
RAL 7000 F.....01

COLOUR OF COMPARTMENTS
TRANSPARENT F.....96



www.famispa.com



PS
compartments



ABS
container structure



SERIES STORAGE PRACTIBOX

WALL SHELVING



■ 01

ORD. NO.**F PG 0410 00 01**Dim. mm **600x28x300 h**

Made from painted sheet steel



■ 96 - compartments ■ 01 - containers

ORD. NO.

DIM. mm

F PG 0410 01 01 600x78x308 h

Including: 4 ORD. NO. F PG 1071 01 01



■ 96 - compartments ■ 01 - containers

ORD. NO.

DIM. mm

F PG 0410 02 01 600x107x300 hIncluding: 1 ORD. NO. F PG 1071 01 01
2 ORD. NO. F PG 1571 01 01

■ 96 - compartments ■ 01 - containers

ORD. NO.

DIM. mm

F PG 0410 03 01 600x150x328 h

Including: 2 ORD. NO. F PG 2071 01 01



■ 01

ORD. NO.**F PG 0420 00 01**Dim. mm **600x28x500 h**

Made from painted sheet steel



■ 96 - compartments ■ 01 - containers

ORD. NO.

DIM. mm

F PG 0420 01 01 600x78x500 h

Including: 6 ORD. NO. F PG 1071 01 01



■ 96 - compartments ■ 01 - containers

ORD. NO.

DIM. mm

F PG 0420 02 01 600x107x500 hIncluding: 2 ORD. NO. F PG 1071 01 01
3 ORD. NO. F PG 1571 01 01

■ 96 - compartments ■ 01 - containers

ORD. NO.

DIM. mm

F PG 0420 03 01 600x183x500 hIncluding: 1 ORD. NO. F PG 1571 01 01
1 ORD. NO. F PG 2071 01 01
1 ORD. NO. F PG 2571 01 01

■ 01

ORD. NO.**F PG 0430 00 01**Dim. mm **600x28x650 h**

Made from painted sheet steel



■ 96 - compartments ■ 01 - containers

ORD. NO.

DIM. mm

F PG 0430 01 01 600x150x664 hIncluding: 3 ORD. NO. F PG 1571 01 01
2 ORD. NO. F PG 2071 01 01

■ 96 - compartments ■ 01 - containers

ORD. NO.

DIM. mm

F PG 0430 02 01 600x107x650 hIncluding: 1 ORD. NO. F PG 1071 01 01
5 ORD. NO. F PG 1571 01 01

■ 96 - compartments ■ 01 - containers

ORD. NO.

DIM. mm

F PG 0430 03 01 600x78x650 h

Including: 8 ORD. NO. F PG 1071 01 01



Wall fixing system with grips and fixing of the Practibox containers to shelving system.

COLOUR OF CONTAINERS
RAL 7000 F.01COLOUR OF COMPARTMENTS
TRANSPARENT F.96

INFO ■

ABS
container structurePS
compartments
www.famispa.com

LENGTH = 600 mm

SERIES STORAGE PRACTIBOX



01

ORD. NO.

F PG 0530 00 01

Dim. mm **600x41x1000 h**

Made from painted sheet steel



96 - compartments 01 - containers

ORD. NO.

DIM. mm

F PG 0530 02 01 600x113x1008 h

Including 9 ORD. NO. F PG 1571 01 01



96 - compartments 01 - containers

ORD. NO.

DIM. mm

F PG 0530 03 01 600x224x1000 h

Including: 2 ORD. NO. F PG 1571 01 01
2 ORD. NO. F PG 2071 01 01
1 ORD. NO. F PG 2571 01 01
1 ORD. NO. F PG 3071 01 01



96 - compartments 01 - containers

ORD. NO.

DIM. mm

F PG 0530 04 01 600x113x1022 h

Including: 6 ORD. NO. F PG 1071 01 01
5 ORD. NO. F PG 1571 01 01



01

ORD. NO.

F PG 0540 00 01

Dim. mm **600x41x1500 h**

Made from painted sheet steel



96 - compartments 01 - containers

ORD. NO.

DIM. mm

F PG 0540 01 01 600x113x1500 h

Including: 9 ORD. NO. F PG 1071 01 01
7 ORD. NO. F PG 1571 01 01

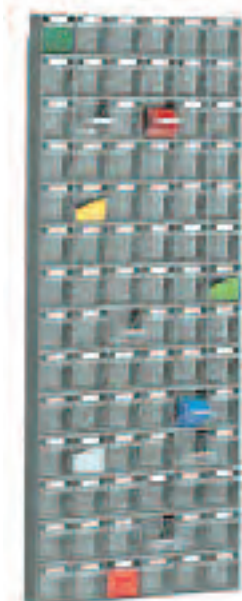

96 - compartments 01 - containers

ORD. NO.

DIM. mm

F PG 0540 02 01 600x113x1568 h

Including: 14 ORD. NO. F PG 1571 01 01



96 - compartments 01 - containers

ORD. NO.

DIM. mm

F PG 0540 03 01 600x224x1540 h

Including: 2 ORD. NO. F PG 1071 01 01
4 ORD. NO. F PG 1571 01 01
3 ORD. NO. F PG 2071 01 01
1 ORD. NO. F PG 2571 01 01
1 ORD. NO. F PG 3071 01 01



INFO

COLOUR OF CONTAINERS
RAL 7000 F.....01

COLOUR OF COMPARTMENTS
TRANSPARENT F.....96



www.famispa.com



PS
compartments



ABS
container structure

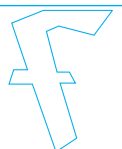

SERIES STORAGE PRACTIBOX



■ 01

ORD. NO.

F PG 0550 00 01

Dim. mm **600x41x1750 h**

Made from painted sheet steel



■ 96 - compartments ■ 01 - containers

ORD. NO.

DIM. mm

F PG 0550 01 01 600x113x1750 h

Including: 8 ORD. NO. F PG 1071 01 01
10 ORD. NO. F PG 1571 01 01



■ 96 - compartments ■ 01 - containers

ORD. NO.

DIM. mm

F PG 0550 02 01 600x113x1757 h

Including: 1 ORD. NO. F PG 1071 01 01
15 ORD. NO. F PG 1571 01 01



■ 96 - compartments ■ 01 - containers

ORD. NO.

DIM. mm

F PG 0550 03 01 600x224x1750 h

Including: 1 ORD. NO. F PG 1071 01 01
6 ORD. NO. F PG 1571 01 01
2 ORD. NO. F PG 2071 01 01
2 ORD. NO. F PG 2571 01 01
1 ORD. NO. F PG 3071 01 01



■ 01

ORD. NO.

F PG 0560 00 01

Dim. mm **600x41x1950 h**

Made from painted sheet steel



■ 96 - compartments ■ 01 - containers

ORD. NO.

DIM. mm

F PG 0560 01 01 600x113x1960 h

Including: 8 ORD. NO. F PG 1071 01 01
12 ORD. NO. F PG 1571 01 01



■ 96 - compartments ■ 01 - containers

ORD. NO.

DIM. mm

F PG 0560 02 01 600x156x1950 h

Including: 3 ORD. NO. F PG 1071 01 01
8 ORD. NO. F PG 1571 01 01
5 ORD. NO. F PG 2071 01 01

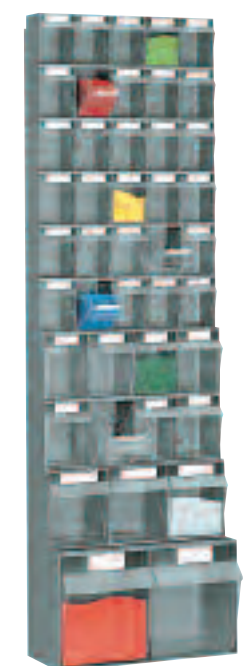

■ 96 - compartments ■ 01 - containers

ORD. NO.

DIM. mm

F PG 0560 03 01 600x326x1989 h

Including: 6 ORD. NO. F PG 2071 01 01
2 ORD. NO. F PG 2571 01 01
1 ORD. NO. F PG 3071 01 01
1 ORD. NO. F PG 3571 01 01

COLOUR OF CONTAINERS
RAL 7000 F.01

COLOUR OF COMPARTMENTS
TRANSPARENT F.96

INFO ■

www.famispa.com

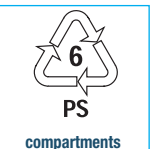
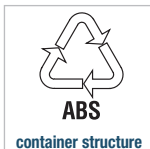

LENGTH = 600 mm

SERIES STORAGE PRACTIBOX

SHELVING WITH BASE



■ 01

ORD. NO.**F PG 0640 00 01**Dim. mm **600x325x1500 h**

Stacking height 1400 mm

Made from painted sheet steel

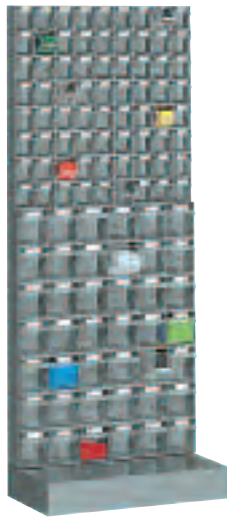

■ 96 - compartments ■ 01 - containers

ORD. NO.

DIM. mm

F PG 0640 01 01 600x325x1500 hIncluding: 8 ORD. NO. F PG 1071 01 01
7 ORD. NO. F PG 1571 01 01

■ 96 - compartments ■ 01 - containers

ORD. NO.

DIM. mm

F PG 0640 02 01 600x325x1556 h

Including: 13 ORD. NO. F PG 1571 01 01



■ 96 - compartments ■ 01 - containers

ORD. NO.

DIM. mm

F PG 0640 03 01 600x325x1528 hIncluding: 2 ORD. NO. F PG 1071 01 01
3 ORD. NO. F PG 1571 01 01
3 ORD. NO. F PG 2071 01 01
1 ORD. NO. F PG 2571 01 01
1 ORD. NO. F PG 3071 01 01

■ 01

ORD. NO.**F PG 0650 00 01**Dim. mm **600x325x1750 h**

Stacking height 1650 mm

Made from painted sheet steel



■ 96 - compartments ■ 01 - containers

ORD. NO.

DIM. mm

F PG 0650 02 01 600x325x1786 hIncluding: 6 ORD. NO. F PG 1071 01 01
8 ORD. NO. F PG 1571 01 01
2 ORD. NO. F PG 2071 01 01

■ 96 - compartments ■ 01 - containers

ORD. NO.

DIM. mm

F PG 0650 03 01 600x325x1750 hIncluding: 2 ORD. NO. F PG 1071 01 01
3 ORD. NO. F PG 1571 01 01
3 ORD. NO. F PG 2071 01 01
2 ORD. NO. F PG 2571 01 01
1 ORD. NO. F PG 3071 01 01

■ 96 - compartments ■ 01 - containers

ORD. NO.

DIM. mm

F PG 0650 04 01 600x325x1770 hIncluding: 5 ORD. NO. F PG 1571 01 01
3 ORD. NO. F PG 2071 01 01
3 ORD. NO. F PG 2571 01 01

■ INFO

**BASE****ORD. NO. F PG 0610 00 01**Dimensions mm **600x300x100 h**
Made from painted sheet steel

■ 01

PS
compartmentsABS
container structureCOLOUR OF CONTAINERS
RAL 7000 F. 01COLOUR OF COMPARTMENTS
TRANSPARENT F. 96

SERIES STORAGE PRACTIBOX

SHELVING WITH BASE



■ 01

ORD. NO.**F PG 0660 00 01**Dim. mm **600x325x1950 h**

Stacking height 1850 mm

Made from painted
sheet steel

■ 96 - compartments ■ 01 - containers

ORD. NO.

DIM. mm

F PG 0660 01 01 600x325x1950 hIncluding: 6 ORD. NO. F PG 1071 01 01
9 ORD. NO. F PG 1571 01 01
1 ORD. NO. F PG 2071 01 01
1 ORD. NO. F PG 2571 01 01

■ 96 - compartments ■ 01 - containers

ORD. NO.

DIM. mm

F PG 0660 02 01 600x325x1950 hIncluding: 2 ORD. NO. F PG 1071 01 01
3 ORD. NO. F PG 1571 01 01
3 ORD. NO. F PG 2071 01 01
3 ORD. NO. F PG 2571 01 01
1 ORD. NO. F PG 3071 01 01

■ 96 - compartments ■ 01 - containers

ORD. NO.

DIM. mm

F PG 0660 03 01 600x325x1976 hIncluding: 5 ORD. NO. F PG 1571 01 01
3 ORD. NO. F PG 2071 01 01
4 ORD. NO. F PG 2571 01 01

LABELS

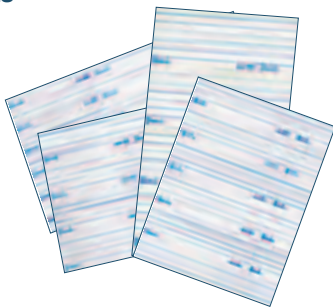
**ORD. NO.**

FOR CONTAINERS ORD. NO.

F PG 9020 00 00 F PG 1071 01 01**F PG 9040 00 00** F PG 1571 01 01**F PG 9060 00 00** F PG 2071 01 01**F PG 9080 00 00** F PG 2571 01 01**F PG 9100 00 00** F PG 3071 01 01**F PG 9120 00 00** F PG 3571 01 01

LOCKING BARS FOR CONTAINERS



■ 99

ORD. NO.

FOR CONTAINER ORD. NO.

F PG 0910 00 99 F PG 1071 01 01**F PG 0915 00 99** F PG 1571 01 01**F PG 0920 00 99** F PG 2071 01 01**F PG 0925 00 99** F PG 2571 01 01**F PG 0930 00 99** F PG 3071 01 01**F PG 0935 00 99** F PG 3571 01 01

locking system

COLOUR OF CONTAINERS
RAL 7000 F.....01COLOUR OF COMPARTMENTS
TRANSPARENT F.....96GALVANISED
F.....99

INFO ■

www.famispa.com

LENGTH =750 mm

SERIES STORAGE PRACTIBOX

CONTAINER TROLLEY

TOOL-TRAY



Front



Rear

■ 01

ORD. NO.

F PG 0121 00 01

Dim. mm 750x660x1420 h

Stacking height 1200 mm

Trolley without Practibox



■ 01

ORD. NO.

F PG 0190 00 01

Dim. mm 600x220x110 h



■ Trolleys series SMART see page D2

TOP-BOX CASE

ROTARY TOWER FOR PRACTIBOX CONTAINERS



■ 96 - compartments ■ 04 - containers

ORD. NO.

F PG 5561 01 04

DIM. mm

350x200x465 h

Complete with 18 compartments

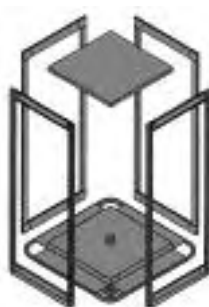

■ 96 - compartments
■ 01 - containers

■ The rotary tower must be fixed to the floor



ORD. NO.

F PG 0226 01 01

WITH 4 FRAMES ORD. NO.

F PG 0550 00 01

Including:

2 ORD. NO. F PG 1071 01 01

18 ORD. NO. F PG 1571 01 01

22 ORD. NO. F PG 2071 01 01

6 ORD. NO. F PG 2571 01 01

■ INFO

COLOUR OF CONTAINERS
RAL 7000 F.01

COLOUR OF COMPARTMENTS
TRANSPARENT F.96



www.famispa.com



PS
compartments



ABS
container structure



SERIES STORAGE PRACTIBOX

- VERTICAL SYSTEM
- LOAD CAPACITY **100 KG PER DRAWER**

■ These cupboards, standard supplied with a single drawer opening device, **MUST BE FIXED** to the floor or wall. The floor-fixing material, if required, can be supplied by **FAMI**.

■ ORD. NO. F SR 8999 00 99

Fixing material including 2 steel floor bolts M8x75 mm for uninterrupted concrete floors equal to or higher than class: B25 / RBK250 / MP_A 25N for mm².



DIMENSIONS mm: 1073x705x2000 h. USABLE WIDTH mm: 967

DIMENSIONS mm: 1481x705x2000 h. USABLE WIDTH mm: 1375

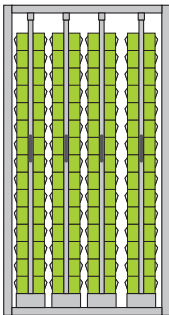

ORD. NO. ■ 01

F PG 0035 01 01 With lock
F PG 0030 01 01 Without lock
with 4 compartments without Practibox

ORD. NO. ■ 01

F PG 0035 51 01 With lock
F PG 0030 51 01 Without lock
with 4 compartments complete of:
120 ORD. NO. F PG 1571 01 01

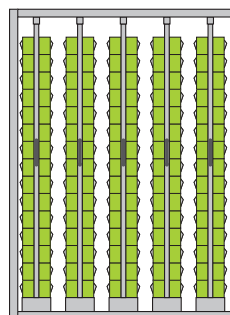

ORD. NO. ■ 01

F PG 0055 01 01 With lock
F PG 0050 01 01 Without lock
with 5 compartments without Practibox

ORD. NO. ■ 01

F PG 0055 51 01 With lock
F PG 0050 51 01 Without lock
with 5 compartments complete of:
150 ORD. NO. F PG 1571 01 01

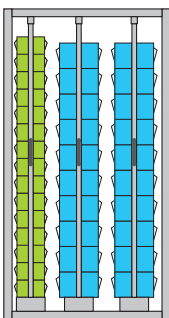

ORD. NO. ■ 01

F PG 0035 02 01 With lock
F PG 0030 02 01 Without lock
with 3 compartments without Practibox

ORD. NO. ■ 01

F PG 0035 52 01 With lock
F PG 0030 52 01 Without lock
with 3 compartments complete of:
30 ORD. NO. F PG 1571 01 01
40 ORD. NO. F PG 2071 01 01

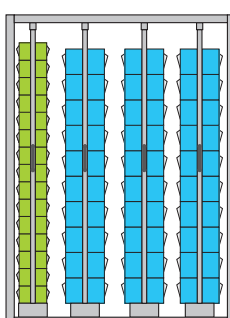

ORD. NO. ■ 01

F PG 0055 02 01 With lock
F PG 0050 02 01 Without lock
with 4 compartments without Practibox

ORD. NO. ■ 01

F PG 0055 52 01 With lock
F PG 0050 52 01 Without lock
with 4 compartments complete of:
30 ORD. NO. F PG 1571 01 01
60 ORD. NO. F PG 2071 01 01

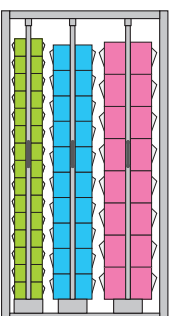

ORD. NO. ■ 01

F PG 0035 03 01 With lock
F PG 0030 03 01 Without lock
with 3 compartments without Practibox

ORD. NO. ■ 01

F PG 0035 53 01 With lock
F PG 0030 53 01 Without lock
with 3 compartments complete of:
30 ORD. NO. F PG 1571 01 01
20 ORD. NO. F PG 2071 01 01
16 ORD. NO. F PG 2571 01 01

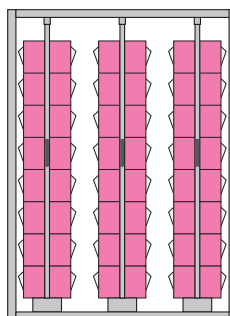

ORD. NO. ■ 01

F PG 0055 03 01 With lock
F PG 0050 03 01 Without lock
with 3 compartments without Practibox

ORD. NO. ■ 01

F PG 0055 53 01 With lock
F PG 0050 53 01 Without lock
with 3 compartments complete of:
48 ORD. NO. F PG 2571 01 01

DIMENSIONS = 1073/1481x705x2000 mm

SERIES STORAGE PRACTIBOX



- VERTICAL SYSTEM
- LOAD CAPACITY 400 KG PER DRAWER

■ These cupboards, standard supplied with a single drawer opening device, **MUST BE FIXED** to the floor or wall. The floor-fixing material, if required, can be supplied by FAMI.

■ ORD. NO. F SR 8999 00 99
Fixing material including 2 steel floor bolts M8x75 mm for uninterrupted concrete floors equal to or higher than class: B25 / RBK250 / MP_A 25N for mm².

DIMENSIONS mm: 1073x705x2000 h. USABLE WIDTH mm: 967

DIMENSIONS mm: 1481x705x2000 h. USABLE WIDTH mm: 1375

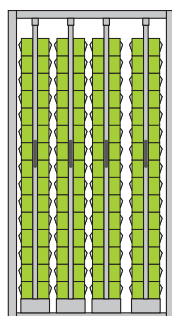

ORD. NO. ■ 01
F PG 0036 01 01 With lock
F PG 0031 01 01 Without lock
 with 4 compartments without Practibox

ORD. NO. ■ 01
F PG 0036 51 01 With lock
F PG 0031 51 01 Without lock
 with 4 compartments complete of:
 120 ORD. NO. F PG 1571 01 01

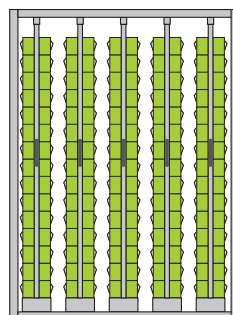

ORD. NO. ■ 01
F PG 0056 01 01 With lock
F PG 0051 01 01 Without lock
 with 5 compartments without Practibox

ORD. NO. ■ 01
F PG 0056 51 01 With lock
F PG 0051 51 01 Without lock
 with 5 compartments complete of:
 150 ORD. NO. F PG 1571 01 01

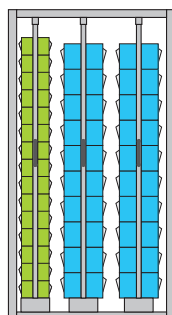

ORD. NO. ■ 01
F PG 0036 02 01 With lock
F PG 0031 02 01 Without lock
 with 3 compartments without Practibox

ORD. NO. ■ 01
F PG 0036 52 01 With lock
F PG 0031 52 01 Without lock
 with 3 compartments complete of:
 30 ORD. NO. F PG 1571 01 01
 40 ORD. NO. F PG 2071 01 01

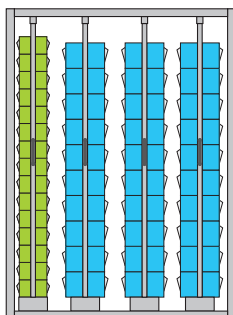

ORD. NO. ■ 01
F PG 0056 02 01 With lock
F PG 0051 02 01 Without lock
 with 4 compartments without Practibox

ORD. NO. ■ 01
F PG 0056 52 01 With lock
F PG 0051 52 01 Without lock
 with 4 compartments complete of:
 30 ORD. NO. F PG 1571 01 01
 60 ORD. NO. F PG 2071 01 01

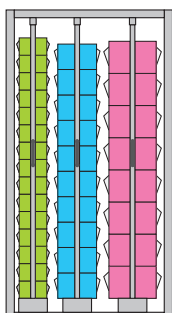

ORD. NO. ■ 01
F PG 0036 03 01 With lock
F PG 0031 03 01 Without lock
 with 3 compartments without Practibox

ORD. NO. ■ 01
F PG 0036 53 01 With lock
F PG 0031 53 01 Without lock
 with 3 compartments complete of:
 30 ORD. NO. F PG 1571 01 01
 20 ORD. NO. F PG 2071 01 01
 16 ORD. NO. F PG 2571 01 01

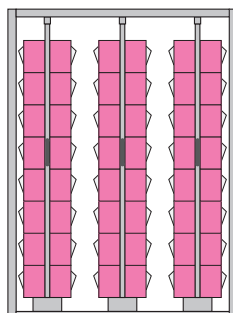

ORD. NO. ■ 01
F PG 0056 03 01 With lock
F PG 0051 03 01 Without lock
 with 3 compartments without Practibox

ORD. NO. ■ 01
F PG 0056 53 01 With lock
F PG 0051 53 01 Without lock
 with 3 compartments complete of:
 48 ORD. NO. F PG 2571 01 01

SERIES STORAGE GOLD BOX



Sliding lid with click closing



The lid can be fastened with a security seal



■ 01



■ 01



■ 01

ORD. NO.

DIM. mm

F PH 3651 AC 01 227x180x100 h

External dim. mm 227x180x100 h

Useful dim. mm 187x136x93 h

Capacity litres 3

Weight gr. 426

Standard colour ■

Bottom **solid**Long sides **closed**Short sides **closed****ORD. NO.**

DIM. mm

F PH 4851 AC 01 336x231x100 h

External dim. mm 336x231x100 h

Useful dim. mm 282x178x90 h

Capacity litres 5

Weight gr. 716

Standard colour ■

Bottom **solid**Long sides **closed**Short sides **closed****ORD. NO.**

DIM. mm

F PH 5251 AC 01 336x231x150 h

External dim. mm 336x231x150 h

Useful dim. mm 285x179x144 h

Capacity litres 8

Weight gr. 818

Standard colour ■

Bottom **solid**Long sides **closed**Short sides **closed**GREY
F.....01**KEY** ■

The containers marked with this symbol can be used to store food-stuffs.



Containers with this symbol are made of completely recyclable plastic material.



STORAGE SECURITY



■ 04

ORD. NO.	DIM. mm
F PH CB51 00 04	147x98x53 h
External dim. mm	147x98x53 h
Useful dim. mm	128x78x45 h
Capacity litres	–
Weight gr.	124
Standard colour	■



To open the lid push
the central part



■ Lid with click closing **CAN NOT BE REUTILIZED**

STORAGE SHELL



■ 04

ORD. NO.	DIM. mm
F PH 0C51 00 04	148x110x28 h
External dim. mm	148x110x28 h
Useful dim. mm	124x83x20 h
Capacity litres	–
Weight gr.	66
Standard colour	■



Hinged lid with click
closing. The lid can be
fastened with a security
seal.



■ KEY

BLUE
F.....04

Containers with this symbol are made of completely recyclable plastic material.

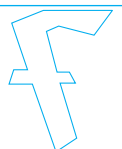

SERIES STORAGE SYSTEM TR

- AVAILABLE IN 2 DIFFERENT HEIGHTS
- FOR STACKING AND STORAGE CONTAINERS



■ 99



Upper shelf galvanised or painted



Cross bracing galvanised



Pair of guides galvanised



Foot galvanised



■ 99

GALVANISED
F. 99

INFO ■

www.famispa.com





99

FIXING SET



Fixing material including 2 steel floor bolts M8x75 mm for uninterrupted concrete floors equal to or higher than class: B25 / RBK250 / MP, 25N for mm².

ORD. NO. F NC 8999 00 99

■ The uprights are fixed to the floor with expansion grip.



99

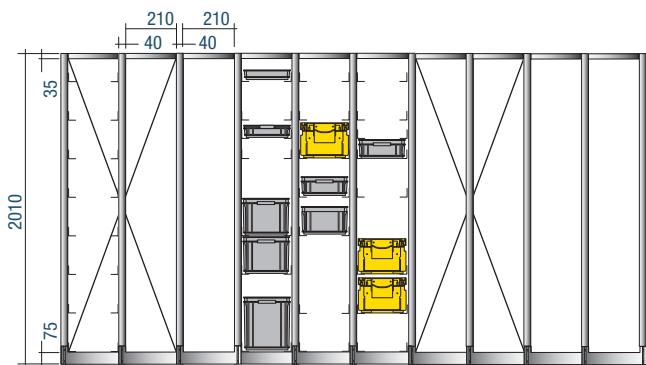

shelving system depth 300 mm



■ The cross bracings are made from galvanised sheet metal. One cross bracing must be fitted every 6 bays to ensure that the shelving system 2000 mm h remains stable.

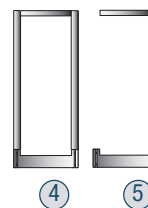
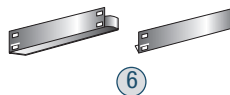
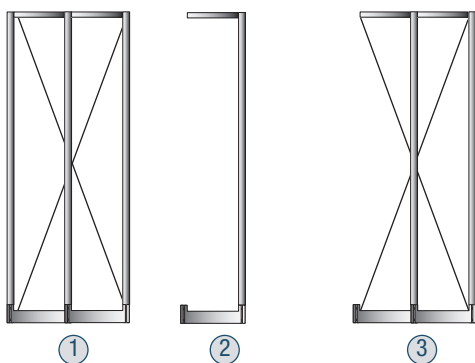
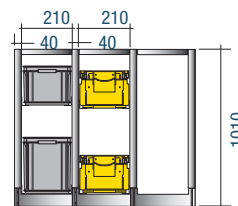

ORD. NO.

TYPE OF BAY
mm

LOAD CAPACITY
PER BAY kg

F TR D200 30 99	① Double unit with cross bracing 2010 h	250
F TR E200 30 99	② Add-on single unit 2010 h	250
F TR F200 30 99	③ Add-on double unit with cross bracing 2010 h	250
F TR G100 30 99	④ Single unit 1010 h	250
F TR E100 30 99	⑤ Add-on single unit 1010 h	250
F TR 9000 00 99	⑥ Pair of galvanised guide rails	50

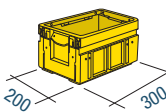
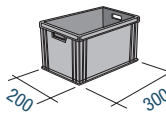

FOR CONTAINERS
DIM. mm

MINIMUM DISTANCE
OF GUIDE RAILS mm

300x200x120 h	150
300x200x170 h	200
300x200x147,5 h	175

■ **INFO**



www.famispa.com

GALVANISED
F. 99



SERIES STORAGE SYSTEM TR

SHELVING SYSTEM SERIES **F TR** FOR CONTAINERS **300x400**



■ 99

FIXING SET



Fixing material including 2 steel floor bolts M8x75 mm for uninterrupted concrete floors equal to or higher than class: B25 / RBK250 / MP_a 25N for mm².

ORD. NO. F NC 8999 00 99

■ The uprights are fixed to the floor with expansion grip.



■ 99

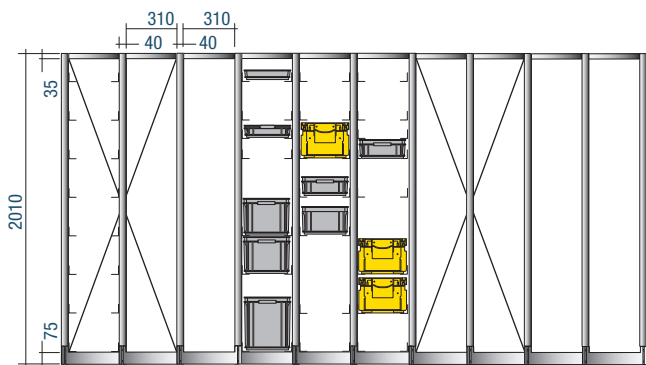

shelving system depth 400 mm



■ The cross bracings are made from galvanised sheet metal. One cross bracing must be fitted every 6 bays to ensure that the shelving system 2000 mm h remains stable.

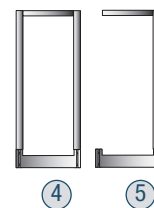
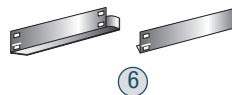
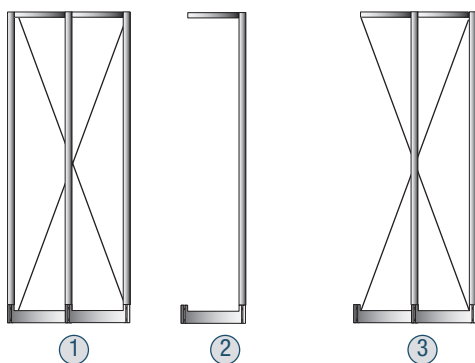
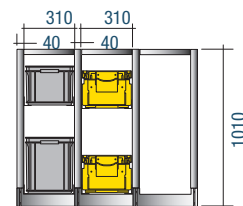

ORD. NO.

TYPE OF BAY
mm

LOAD CAPACITY
PER BAY kg

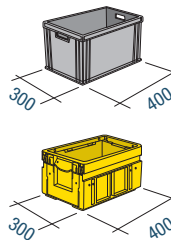

F TR D200 40 99	① Double unit with cross bracing 2010 h	250
F TR E200 40 99	② Add-on single unit 2010 h	250
F TR F200 40 99	③ Add-on double unit with cross bracing 2010 h	250
F TR G100 40 99	④ Single unit 1010 h	250
F TR E100 40 99	⑤ Add-on single unit 1010 h	250
F TR 9040 00 99	⑥ Pair of galvanised guide rails	50

FOR CONTAINERS
DIM. mm

MINIMUM DISTANCE
OF GUIDE RAILS mm

400x300x55 h	75
400x300x78 h	100
400x300x120 h	150
400x300x170 h	200
400x300x220 h	250
400x300x325 h	350

GALVANISED
F. 99

INFO ■





FIXING SET



Fixing material including 2 steel floor bolts M8x75 mm for uninterrupted concrete floors equal to or higher than class: B25 / RBK250 / MP_a 25N for mm².

ORD. NO. F NC 8999 00 99

■ The uprights are fixed to the floor with expansion grip.

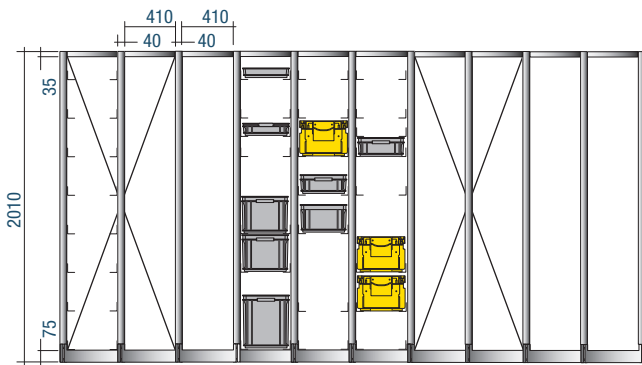

shelving system depth 600 mm



■ The cross bracings are made from galvanised sheet metal. One cross bracing must be fitted every 6 bays to ensure that the shelving system 2000 mm h remains stable.

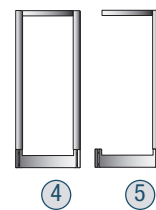
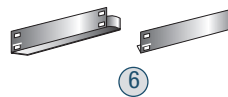
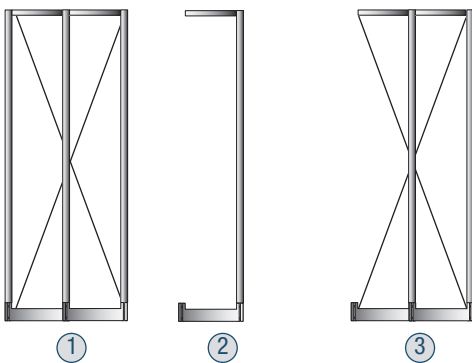
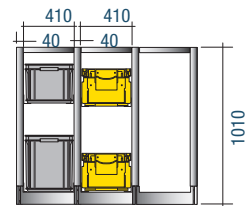

ORD. NO.

TYPE OF BAY
mm

LOAD CAPACITY
PER BAY kg

F TR D200 60 99	① Double unit with cross bracing 2010 h	250
F TR E200 60 99	② Add-on single unit 2010 h	250
F TR F200 60 99	③ Add-on double unit with cross bracing 2010 h	250
F TR G100 60 99	④ Single unit 1010 h	250
F TR E100 60 99	⑤ Add-on single unit 1010 h	250
F TR 9080 00 99	⑥ Pair of galvanised guide rails	50

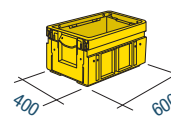
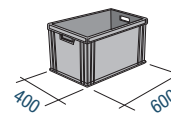

FOR CONTAINERS
DIM. mm

MINIMUM DISTANCE
OF GUIDE RAILS mm

600x400x78 h	100
600x400x120 h	150
600x400x170 h	200
600x400x220 h	250
600x400x285 h	325
600x400x325 h	350
600x400x430 h	450

■ **INFO**



www.famispa.com

GALVANISED
F. 99

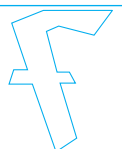

SERIES STORAGE SYSTEM TR

SHELVING SYSTEM SERIES F TR 223x350 FOR CONTAINERS SIZE 3A2/3



FIXING SET



Fixing material including 2 steel floor bolts M8x75 mm for uninterrupted concrete floors equal to or higher than class: B25 / RBK250 / MPa 25N for mm².

ORD. NO. F NC 8999 00 99

■ The uprights are fixed to the floor with expansion grip.

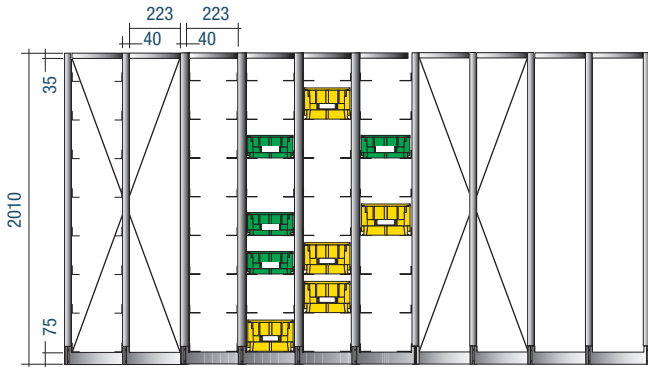

shelving system depth 350 mm



■ The cross bracings are made from galvanised sheet metal. One cross bracing must be fitted every 6 bays to ensure that the shelving system 2000 mm h remains stable.

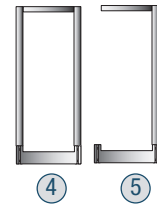
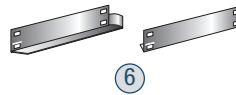
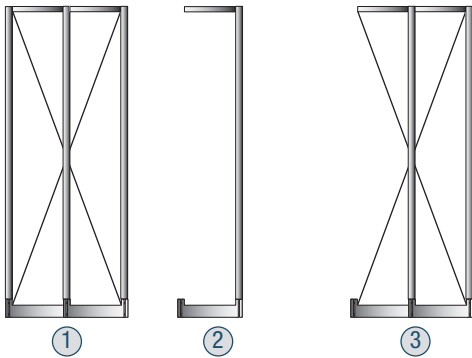
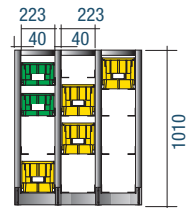

ORD. NO.	TYPE OF BAY mm	LOAD CAPACITY PER BAY kg
F TR D200 35 99	① Double unit with cross bracing 2010 h	250
F TR E200 35 99	② Add-on single unit 2010 h	250
F TR F200 35 99	③ Add-on double unit with cross bracing 2010 h	250
F TR G100 35 99	④ Single unit 1010 h	250
F TR E100 35 99	⑤ Add-on single unit 1010 h	250
F TR 9020 00 99	⑥ Pair of galvanised guide rails	50

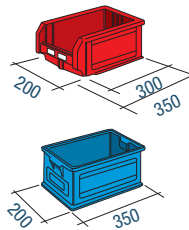

FOR CONTAINERS SIZE	MINIMUM DISTANCE OF GUIDE RAILS mm
3A2	175
3	225
272-3A2	175
272-3	225

GALVANISED F. 99

INFO ■



SHELVING SYSTEM SERIES **F TR 323x500** FOR CONTAINERS SIZE 4/4A2/4A5



99

FIXING SET



Fixing material including 2 steel floor bolts M8x75 mm for uninterrupted concrete floors equal to or higher than class: B25 / RBK250 / MPa. 25N for mm².

ORD. NO. F NC 8999 00 99

■ The uprights are fixed to the floor with expansion grip.



99

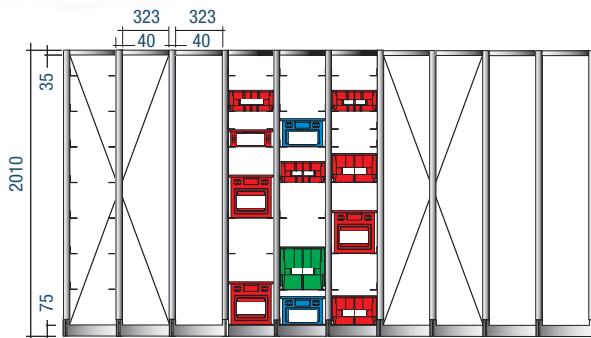

shelving system depth 500 mm



■ The cross bracings are made from galvanised sheet metal. One cross bracing must be fitted every 6 bays to ensure that the shelving system 2000 mm h remains stable.

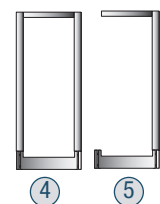
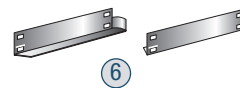
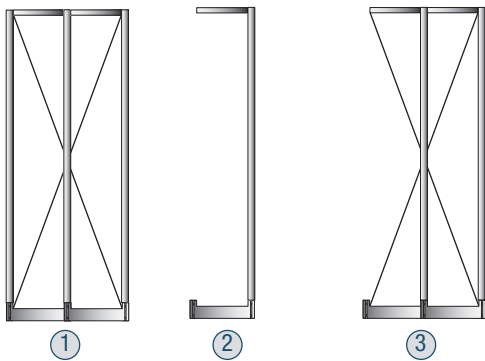
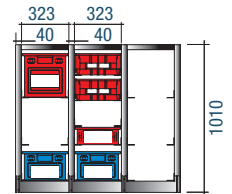

ORD. NO.	TYPE OF BAY mm	LOAD CAPACITY PER BAY kg
F TR D200 50 99	① Double unit with cross bracing 2010 h	250
F TR E200 50 99	② Add-on single unit 2010 h	250
F TR F200 50 99	③ Add-on double unit with cross bracing 2010 h	250
F TR G100 50 99	④ Single unit 1010 h	250
F TR E100 50 99	⑤ Add-on single unit 1010 h	250
F TR 9060 00 99	⑥ Pair of galvanised guide rails	50

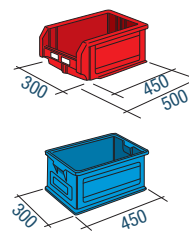

FOR CONTAINERS SIZE	MINIMUM DISTANCE OF GUIDE RAILS mm
272-4A2	150
272-4	225
272-4A5	325
4A2	200
4	225
4A5	325

■ **INFO**

GALVANISED
F. 99



www.famispa.com

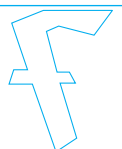

SERIES STORAGE DOMINO

■ FOR PLASTIC AND STEEL CONTAINERS

■ STACKABLE

■ The shelving system must be fixed to the floor and/or to the wall.

Handy work stations for distributing the materials can be obtained by connecting accessories (base plinths, work top and dust cover) to the shelf units.



Each container can be removed quickly and easily and a special hook fitted to the shelf unit prevents the container from accidentally falling out.



detail of hook

SHELVING UNITS SERIES **F ED 3044**



■ 01

■ Shelving unit **without** containers



size 3
Containers:
see page from
G28 to G41



STACKABLE

ORD. NO. SHELVING	Stacked units	Load capacity for each unit	Load capacity for each box
F ED 3044 00 01	2 max 3	960 kg 640 kg	60 kg 40 kg

ORD. NO.	DIM. mm
F ED 3044 00 01	1025x310x885 h

Max q.ty of stacking containers which can be fitted: **16 pcs size 3**

ORD. NO.	DIM. mm
F ED 9034 00 01	1020x315x20 h

Dust cover. For shelving ORD. NO. F ED 3044 00 01

ORD. NO.	DIM. mm
F ED 9134 00 01	1025x315x32 h

Work top. For shelving ORD. NO. F ED 3044 00 01

ORD. NO.	DIM. mm
F ED 9234 00 01	1020x315x85 h

Base plinth. For shelving ORD. NO. F ED 3044 00 01

SHELVING UNITS SERIES **F ED 3074**

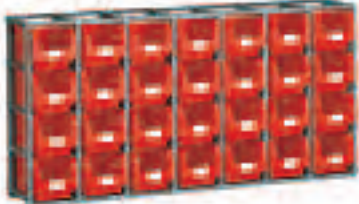

■ 01

■ Shelving unit **without** containers



size 3
Containers:
see page from
G28 to G41

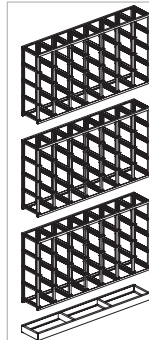

STACKABLE

ORD. NO. SHELVING	Stacked units	Load capacity for each unit	Load capacity for each box
F ED 3074 00 01	2 max 3	1680 kg 1120 kg	60 kg 40 kg

ORD. NO.	DIM. mm
F ED 3074 00 01	1765x310x885 h

Max q.ty of stacking containers which can be fitted: **28 pcs size 3**

ORD. NO.	DIM. mm
F ED 9037 00 01	1765x315x20 h

Dust cover. For shelving ORD. NO. F ED 3074 00 01

ORD. NO.	DIM. mm
F ED 9137 00 01	1770x315x32 h

Work top. For shelving ORD. NO. F ED 3074 00 01

ORD. NO.	DIM. mm
F ED 9237 00 01	1765x315x85 h

Base plinth. For shelving ORD. NO. F ED 3074 00 01

RAL 7000
F.....01

INFO ■



FOR PLASTIC AND STEEL CONTAINERS

SERIES STORAGE DOMINO

SHELVING UNITS SERIES F ED 4034



■ 01

■ Shelving unit **without** containers

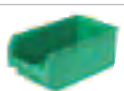

size 4
Containers:
see page from
G28 to G41

STACKABLE

ORD. NO. SHELVING	Stacked units	Load capacity for each unit	Load capacity for each box
F ED 4034 00 01	max 3	1200 kg	100 kg

ORD. NO. DIM. mm

F ED 4034 00 01 1075x460x885 h

Max q.ty of stacking containers which can be fitted: **12 pcs size 4**



■ 01

ORD. NO. DIM. mm

F ED 9043 00 01 1070x465x20 h

Dust cover. For shelving ORD. NO. F ED 4034 00 01



■ 01

ORD. NO. DIM. mm

F ED 9143 00 01 1075x465x32 h

Work top. For shelving ORD. NO. F ED 4034 00 01



■ 01

ORD. NO. DIM. mm

F ED 9243 00 01 1070x465x85 h

Base plinth. For shelving ORD. NO. F ED 4034 00 01

SHELVING UNITS SERIES F ED 4054

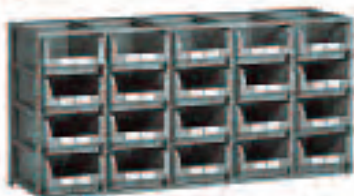

■ 01

■ Shelving unit **without** containers

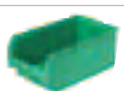

size 4
Containers:
see page from
G28 to G41

STACKABLE

ORD. NO. SHELVING	Stacked units	Load capacity for each unit	Load capacity for each box
F ED 4054 00 01	max 3	1600 kg	80 kg

ORD. NO. DIM. mm

F ED 4054 00 01 1765x460x885 h

Max q.ty of stacking containers which can be fitted: **20 pcs size 4**



■ 01

ORD. NO. DIM. mm

F ED 9045 00 01 1765x465x20 h

Dust cover
For shelving ORD. NO. F ED 4054 00 01 / F ED 4056 00 01



■ 01

ORD. NO. DIM. mm

F ED 9145 00 01 1770x465x32 h

Work top
For shelving ORD. NO. F ED 4054 00 01 / F ED 4056 00 01



■ 01

ORD. NO. DIM. mm

F ED 9245 00 01 1765x465x85 h

Base plinth
For shelving ORD. NO. F ED 4054 00 01 / F ED 4056 00 01

SHELVING UNITS SERIES F ED 4056



■ 01

■ Shelving unit **without** containers

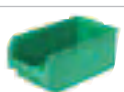

size 4
Containers:
see page from
G28 to G41

STACKABLE

ORD. NO. SHELVING	Stacked units	Load capacity for each unit	Load capacity for each box
F ED 4056 00 01	2 max 3	2400 kg 1500 kg	80 kg 50 kg

ORD. NO. DIM. mm

F ED 4056 00 01 1765x460x1300 h

Max q.ty of stacking containers which can be fitted: **30 pcs size 4**



■ 01

ORD. NO. DIM. mm

F ED 9045 00 01 1765x465x20 h

Dust cover
For shelving ORD. NO. F ED 4054 00 01 / F ED 4056 00 01



■ 01

ORD. NO. DIM. mm

F ED 9145 00 01 1770x465x32 h

Work top
For shelving ORD. NO. F ED 4054 00 01 / F ED 4056 00 01



■ 01

ORD. NO. DIM. mm

F ED 9245 00 01 1765x465x85 h

Base plinth
For shelving ORD. NO. F ED 4054 00 01 / F ED 4056 00 01

■ INFO

RAL 7000
F.....01



www.famispa.com



SERIES STORAGE DOMINO

SHELVING UNITS SERIES **F ED 4555**

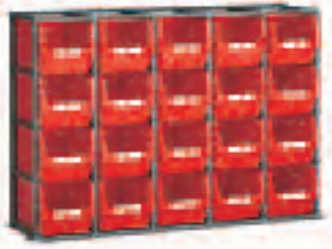

■ 01

■ Shelving unit **without** containers



size 4A5
Containers: see page from **G28 to G41**

STACKABLE

ORD. NO. SHELVING	Stacked units	Load capacity for each unit	Load capacity for each box
F ED 4555 00 01	2 max 3	1600 kg 1000 kg	80 kg 50 kg

ORD. NO. **F ED 4555 00 01** **DIM. mm** **1765x460x1300 h**
Max q.ty of stacking containers which can be fitted: **20 pcs size 4A5**

ORD. NO. **F ED 9045 00 01** **DIM. mm** **1765x465x20 h**
Dust cover. For shelving ORD. NO. F ED 4555 00 01

ORD. NO. **F ED 9145 00 01** **DIM. mm** **1770x465x32 h**
Work top. For shelving ORD. NO. F ED 4555 00 01

ORD. NO. **F ED 9245 00 01** **DIM. mm** **1765x465x85 h**
Base plinth. For shelving ORD. NO. F ED 4555 00 01

SHELVING UNITS SERIES **F ED 5023**

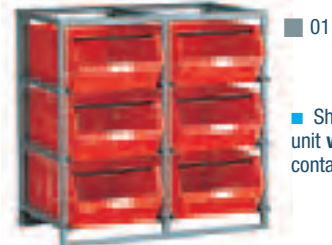

■ 01

■ Shelving unit **without** containers



size 5
Containers: see page from **G28 to G41**

STACKABLE

ORD. NO. SHELVING	Stacked units	Load capacity for each unit	Load capacity for each box
F ED 5023 00 01	max 3	1200 kg	200 kg

ORD. NO. **F ED 5023 00 01** **DIM. mm** **1125x660x1180 h**
Max q.ty of stacking containers which can be fitted: **6 pcs size 5**

ORD. NO. **F ED 9052 00 01** **DIM. mm** **1120x665x30 h**
Dust cover. For shelving ORD. NO. F ED 5023 00 01

ORD. NO. **F ED 9352 00 01** **DIM. mm** **1125x660x155 h**
Base plinth. For shelving ORD. NO. F ED 5023 00 01

SHELVING UNITS SERIES **F ED 5033**

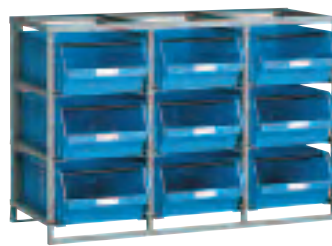

■ 01

■ Shelving unit **without** containers



size 5
Containers: see page from **G28 to G41**

STACKABLE

ORD. NO. SHELVING	Stacked units	Load capacity for each unit	Load capacity for each box
F ED 5033 00 01	max 3	1800 kg	200 kg

ORD. NO. **F ED 5033 00 01** **DIM. mm** **1670x660x1180 h**
Max q.ty of stacking containers which can be fitted: **9 pcs size 5**

ORD. NO. **F ED 9053 00 01** **DIM. mm** **1667x665x30 h**
Dust cover. For shelving ORD. NO. F ED 5033 00 01

ORD. NO. **F ED 9353 00 01** **DIM. mm** **1670x660x155 h**
Base plinth. For shelving ORD. NO. F ED 5033 00 01

RAL 7000
F.....01

INFO ■

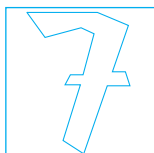

ROTARY SAFETY LADDER FOR SHELVING UNITS STORAGE DOMINO

SERIES STORAGE DOMINO

ROTARY SAFETY LADDER FOR SHELVING UNITS STORAGE DOMINO

This ladder makes it safe and easy to reach even the containers located in the highest part of the shelf unit. Designed and produced for totally safe operation, the ladder runs along guide rails and can be open either to the right or to the left or closed in order to leave space free in the corridor. It can be locked into place with a brake that can then be released when the ladder needs to be moved again.



■ SAFETY

The level of safety of the ladder depends on the stability of the shelf system to which is fixed. For further information please ask for the technical specifications.

The shelving units can be placed one above the other in order to obtain real and proper stores with personalised horizontal and vertical layout.



■ 30

ORD. NO. LADDER **A**

FOR SHELVING SYSTEM

F QG 2227 00 30 height of ladder 2270 mm	F ED 4054 00 01+ F ED 4056 00 01+ F ED 9245 00 01	-	-	-
F QG 2251 00 30 height of ladder 2515 mm	F ED 5023 00 01+ F ED 5023 00 01+ F ED 9352 00 01	F ED 5033 00 01+ F ED 5033 00 01+ F ED 9353 00 01+	-	-
F QG 2270 00 30 height of ladder 2685-2740 mm	F ED 3044 00 01+ F ED 3044 00 01+ F ED 3044 00 01+ F ED 9234 00 01	F ED 3074 00 01+ F ED 3074 00 01+ F ED 3074 00 01+ F ED 9237 00 01	F ED 4034 00 01+ F ED 4034 00 01+ F ED 4034 00 01+ F ED 9243 00 01	F ED 4054 00 01+ F ED 4054 00 01+ F ED 4054 00 01+ F ED 9245 00 01
F QG 2270 00 30 height of ladder 2685-2740 mm	F ED 4056 00 01+ F ED 4056 00 01+ F ED 9245 00 01	F ED 4555 00 01+ F ED 4555 00 01+ F ED 9245 00 01	-	-

GUIDE RAILS APPLICABLE TO THE SHELVING

ORD. NO. **B**

F QG 9200 00 01

Upper and lower guide rails per linear metre

N.B. The shelving system can only be stacked if the units have the same base dimensions.

- 01
- 02
- 04
- 08



■ 30

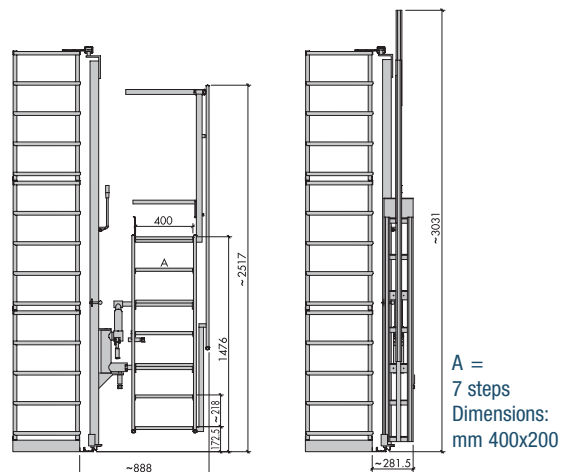

■ INFO

- RAL 7000 F. 01
- RAL 6011 F. 02
- RAL 5012 F. 04
- RAL 7035 F. 08
- RAL 1004 F. 30



www.famispa.com

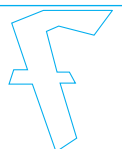

SERIES STORAGE ESD ATHENA

- SPECIAL CONDUCTIVE PLASTIC FAMI 408 L
- PARTICULARLY SUITABLE FOR THE ELECTRONICS INDUSTRY



TECHNICAL SPECIFICATIONS

Base material	Polypropylene copolymer (PPC)
Conductivity additive	Carbon black
Colour	Black
Density, at 23°C	1.04 g/cm³
Vicat softening point	154°C ISO 306
Working temperature continuous	approx 80-100°C
Working temperature short term	approx 100-120°C
Surface resistance	less than 10 ⁴ Ω cm (measured according to CEI EN 61340-2-3 at 20°C with a 5 cm² ring electrode).
Volume resistivity	10 ⁴ Ω cm (measured according to CEI EN 61340-2-3 at 20°C with a 5 cm² ring electrode)
Ageing behaviour	No deterioration of conductivity (in 7 years of service), no leaching of corrosive substances, excellent UV resistance.
Chemical resistance	Excellent (according to the generally valid PP classification)

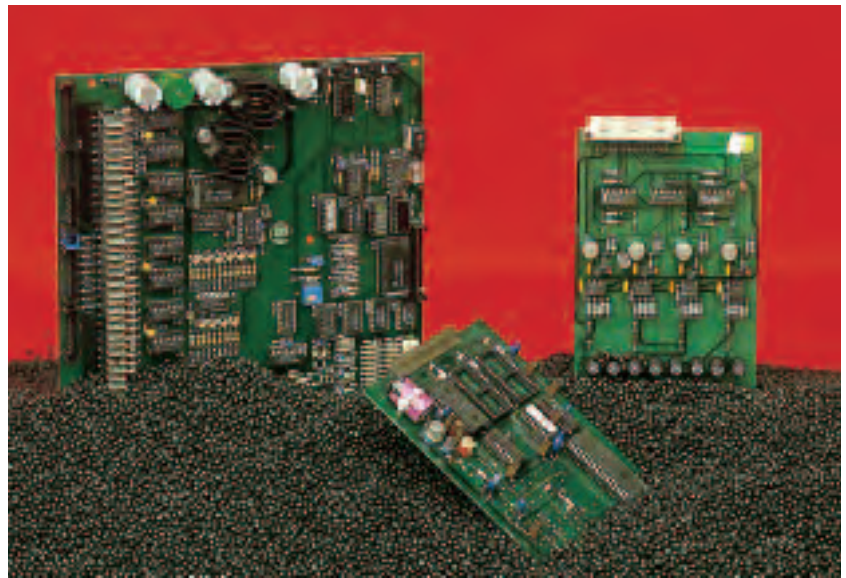

shock-resistant



fitting the hooked lid



fitting the sliding lid



CONDUCTIVITY SCALE

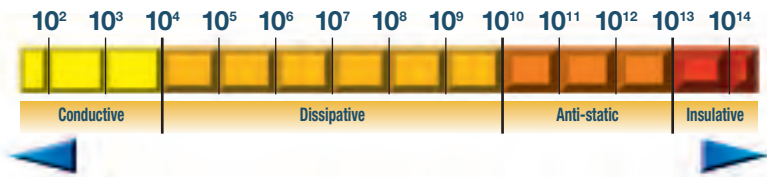

BLACK
F.07

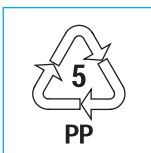
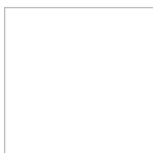
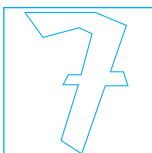

KEY



Containers with this symbol are made of completely recyclable plastic material.

- Resistant to high and low temperatures



DIMENSIONS = 300x200 / 400x300 mm

SERIES STORAGE ESD ATHENA

CONDUCTIVE STACKING CONTAINERS ATHENA SERIES 300x200



ORD. NO.	DIM. mm
F PA 2452 A0 07	300x200x120 h
External dim. mm	300x200x120 h. Internal dim. mm 260x160x100 h
Capacity litres	5
Weight gr.	520
Bottom	solid
Long sides	closed
Short sides	closed
Lifting	bars
Label holder: ORD. NO. F PZ 0010 00 99 . See page G77	

LIDS FOR CONDUCTIVE STACKING CONTAINERS



ORD. NO.	FOR CONTAINERS ATHENA mm	LID TYPE
F PA 0352 00 07	300x200	hinged lid
F PA 0652 00 07	400x300	hinged lid
F PA 1B52 00 07	400x300	with handles
F PA 1652 00 07	400x300	sliding lid
F PA 0952 00 07	600x400	hinged lid
F PA 1C52 00 07	600x400	with handles
F PA 1252 00 07	800x600	-
F PA 1252 01 07	800x600	with handles

CONDUCTIVE STACKING CONTAINERS ATHENA SERIES 400x300

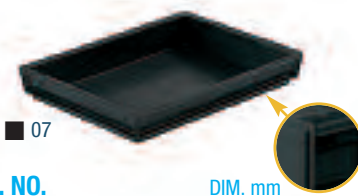

ORD. NO.	DIM. mm
F PA 3252 A0 07	400x300x55 h
External dim. mm	400x300x55 h
Internal dim. mm	355x254x37 h
Capacity litres	3,8
Weight gr.	540
Bottom	solid
Long sides	closed
Short sides	closed
Lifting	bars
Label holder: ORD. NO. F PZ 0010 00 99 . See page G77	

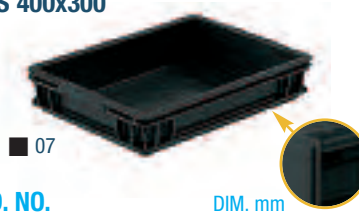

ORD. NO.	DIM. mm
F PA 3652 A0 07	400x300x78 h
External dim. mm	400x300x78 h
Internal dim. mm	355x255x59 h
Capacity litres	6
Weight gr.	640
Bottom	solid
Long sides	closed
Short sides	closed
Lifting	bars
Label holder: ORD. NO. F PZ 0010 00 99 . See page G77	

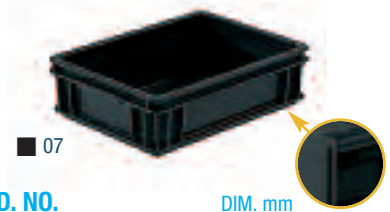

ORD. NO.	DIM. mm
F PA 4052 A0 07	400x300x120 h
External dim. mm	400x300x120 h
Internal dim. mm	357x257x102 h
Capacity litres	10
Weight gr.	890
Bottom	solid
Long sides	closed
Short sides	closed
Lifting	bars
Label holder: ORD. NO. F PZ 0010 00 99 . See page G77	



ORD. NO.	DIM. mm
F PA 4452 A0 07	400x300x170 h
External dim. mm	400x300x170 h
Internal dim. mm	357x257x152 h
Capacity litres	15
Weight gr.	1220
Bottom	solid
Long sides	closed
Short sides	closed
Lifting	bars
Label holder: ORD. NO. F PZ 9551 00 07 ORD. NO. F PZ 0010 00 99 . See page G77	



ORD. NO.	DIM. mm
F PA 4852 A0 07	400x300x220 h
External dim. mm	400x300x220 h
Internal dim. mm	357x258x207 h
Capacity litres	20
Weight gr.	1360
Bottom	solid
Long sides	closed
Short sides	closed
Lifting	bars
Label holder: ORD. NO. F PZ 9551 00 07 ORD. NO. F PZ 0010 00 99 . See page G77	



ORD. NO.	DIM. mm
F PA 5252 A0 07	400x300x325 h
External dim. mm	400x300x325 h
Internal dim. mm	356x255x307 h
Capacity litres	30
Weight gr.	2240
Bottom	solid
Long sides	closed
Short sides	closed
Lifting	bars
Label holder: ORD. NO. F PZ 9551 00 07 ORD. NO. F PZ 0010 00 99 . See page G77	

KEY



Containers with this symbol are made of completely recyclable plastic material.

■ Resistant to high and low temperatures

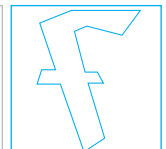
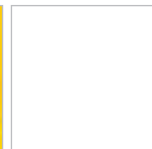

■ BLACK
F.....07

SERIES STORAGE ESD ATHENA



■ 07

ORD. NO.

DIM. mm

F PA 5652 AO 07 600x400x78 h

External dim. mm 600x400x78 h

Internal dim. mm 555x355x60 h

Capacity litres 10

Weight gr. 1600

Bottom **solid**Long sides **closed**Short sides **closed**Lifting **bars**Label holder: ORD. NO. **F PZ 0010 00 99**

See page G77

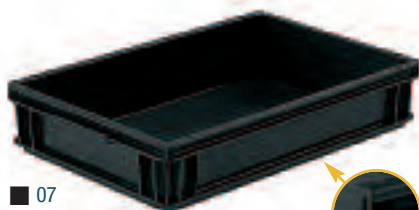

■ 07

ORD. NO.

DIM. mm

F PA 6052 AO 07 600x400x120 h

External dim. mm 600x400x120 h

Internal dim. mm 557x357x102 h

Capacity litres 20

Weight gr. 1750

Bottom **solid**Long sides **closed**Short sides **closed**Lifting **bars**Label holder: ORD. NO. **F PZ 0010 00 99**

See page G77



■ 07

ORD. NO.

DIM. mm

F PA 6452 AO 07 600x400x170 h

External dim. mm 600x400x170 h

Internal dim. mm 560x358x153 h

Capacity litres 30

Weight gr. 2310

Bottom **solid**Long sides **closed**Short sides **closed**Lifting **bars**Label holder: ORD. NO. **F PZ 9751 00 07**ORD. NO. **F PZ 0010 00 99**. See page G77

■ 07

ORD. NO.

DIM. mm

F PB 6852 AO 07 600x400x220 h

External dim. mm 600x400x220 h

Internal dim. mm 555x355x203 h

Capacity litres 40

Weight gr. 2160

Bottom **solid**Long sides **closed**Short sides **closed**Lifting **bars**Label holder: ORD. NO. **F PZ 9751 00 07**ORD. NO. **F PZ 0010 00 99**. See page G77

■ 07

ORD. NO.

DIM. mm

F PA 7252 AO 07 600x400x285 h

External dim. mm 600x400x285 h

Internal dim. mm 557x356x263 h

Capacity litres 53

Weight gr. 3358

Bottom **solid**Long sides **closed**Short sides **closed**Lifting **bars**Label holder: ORD. NO. **F PZ 9751 00 07**ORD. NO. **F PZ 0010 00 99**. See page G77

■ 07

ORD. NO.

DIM. mm

F PA 7652 AO 07 600x400x325 h

External dim. mm 600x400x325 h

Internal dim. mm 558x358x308 h

Capacity litres 60

Weight gr. 3620

Bottom **solid**Long sides **closed**Short sides **closed**Lifting **bars**Label holder: ORD. NO. **F PZ 9751 00 07**ORD. NO. **F PZ 0010 00 99**. See page G77

■ 07

ORD. NO.

DIM. mm

F PA 8052 BO 07 600x400x430 h

External dim. mm 600x400x430 h

Internal dim. mm 557x356x415 h

Capacity litres 90

Weight gr. 4250

Bottom **solid**Long sides **closed**Short sides **closed**Lifting **hole**Label holder: ORD. NO. **F PZ 9751 00 07**ORD. NO. **F PZ 0010 00 99**. See page G77BLACK
F. 07

KEY ■



Containers with this symbol are made of completely recyclable plastic material.

- Resistant to high and low temperatures



DIMENSIONS = 800x600 mm

SERIES STORAGE ESD ATHENA



■ 07

Reinforced bottom



ORD. NO.	DIM. mm
F PA 8552 AO 07	800x600x120 h
External dim. mm	800x600x120 h
Internal dim. mm	757x557x86 h
Capacity litres	49
Weight gr.	3920
Bottom	reinforced
Long sides	closed
Short sides	closed
Lifting	bars

Label holder: ORD. NO. **F PZ 0010 00 99**
See page G77



■ 07

Reinforced bottom



ORD. NO.	DIM. mm
F PA 8752 AO 07	800x600x170 h
External dim. mm	800x600x170 h
Internal dim. mm	758x555x137 h
Capacity litres	69
Weight gr.	4356
Bottom	reinforced
Long sides	closed
Short sides	closed
Lifting	bars

Label holder: ORD. NO. **F PZ 9751 00 07**
ORD. NO. **F PZ 0010 00 99**. See page G77



■ 07

Reinforced bottom



ORD. NO.	DIM. mm
F PA 8952 AO 07	800x600x220 h
External dim. mm	800x600x220 h
Internal dim. mm	757x556x188 h
Capacity litres	90
Weight gr.	5310
Bottom	reinforced
Long sides	closed
Short sides	closed
Lifting	bars

Label holder: ORD. NO. **F PZ 9751 00 07**
ORD. NO. **F PZ 0010 00 99**. See page G77



■ Detail of stacking containers with reinforced bottom 800x600 mm



■ Solid bottom on request



■ 07

Reinforced bottom



ORD. NO.	DIM. mm
F PA 9352 AO 07	800x600x325 h
External dim. mm	800x600x325 h
Internal dim. mm	756x555x294 h
Capacity litres	130
Weight gr.	5780
Bottom	reinforced
Long sides	closed
Short sides	closed
Lifting	bars

Label holder: ORD. NO. **F PZ 9751 00 07**
ORD. NO. **F PZ 0010 00 99**. See page G77

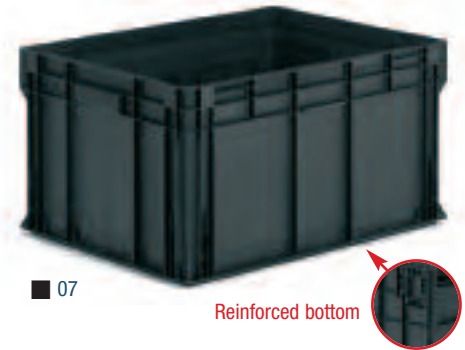

■ 07

Reinforced bottom



ORD. NO.	DIM. mm
F PA 9752 AO 07	800x600x430 h
External dim. mm	800x600x430 h
Internal dim. mm	756x555x395 h
Capacity litres	175
Weight gr.	6750
Bottom	reinforced
Long sides	closed
Short sides	closed
Lifting	bars

Label holder: ORD. NO. **F PZ 9751 00 07**
ORD. NO. **F PZ 0010 00 99**. See page G77

LIDS FOR CONDUCTIVE STACKING CONTAINERS ATHENA SERIES



■ 07

ORD. NO.	LID
F PA 1252 01 07	800x600
Weight gr.	1925

For containers ord. no. **F PA 8552 AO 07**



■ 07

ORD. NO.	LID
F PA 1252 00 07	800x600
Weight gr.	2160

For containers ord. no. **F PA 8752 AO 07, F PA 8952 AO 07, F PA 9352 AO 07, F PA 9752 AO 07**

■ KEY



Containers with this symbol are made of completely recyclable plastic material.

■ Resistant to high and low temperatures

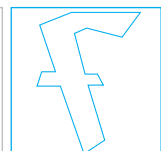
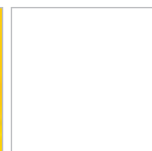

■ BLACK
F.....07

SERIES STORAGE ESD ATHENA

**CONTAINER INCLUDING
1 SET OF FOUR FEET**

- Supplied assembled



■ 07

ORD. NO.	DIM. mm
F PA 8552 AD 07	800x600x220 h
Container height mm 120	
Capacity litres 49	

ORD. NO.	DIM. mm
F PA 8752 AD 07	800x600x270 h
Container height mm 170	
Capacity litres 69	

ORD. NO.	DIM. mm
F PA 8952 AD 07	800x600x320 h
Container height mm 220	
Capacity litres 90	

ORD. NO.	DIM. mm
F PA 9352 AD 07	800x600x425 h
Container height mm 325	
Capacity litres 130	

ORD. NO.	DIM. mm
F PA 9752 AD 07	800x600x530 h
Container height mm 430	
Capacity litres 175	

**CONTAINER INCLUDING
1 SET OF FOUR FEET AND
1 PAIR OF CONNECTION PIECE**

- Supplied assembled



■ 07

ORD. NO.	DIM. mm
F PA 8552 AE 07	800x600x245 h
Container height mm 120	
Capacity litres 49	

ORD. NO.	DIM. mm
F PA 8752 AE 07	800x600x295 h
Container height mm 170	
Capacity litres 69	

ORD. NO.	DIM. mm
F PA 8952 AE 07	800x600x345 h
Container height mm 220	
Capacity litres 90	

ORD. NO.	DIM. mm
F PA 9352 AE 07	800x600x450 h
Container height mm 325	
Capacity litres 130	

ORD. NO.	DIM. mm
F PA 9752 AE 07	800x600x555 h
Container height mm 430	
Capacity litres 175	

**CONTAINER INCLUDING
1 SET OF FOUR 100 mm Ø
CONDUCTIVE SWIVEL WHEELS**

- Supplied assembled



■ 07

ORD. NO.	DIM. mm
F PA 8552 AF 07	800x600x245 h
Container height mm 120	
Capacity litres 49	

ORD. NO.	DIM. mm
F PA 8752 AF 07	800x600x295 h
Container height mm 170	
Capacity litres 69	

ORD. NO.	DIM. mm
F PA 8952 AF 07	800x600x345 h
Container height mm 220	
Capacity litres 90	

ORD. NO.	DIM. mm
F PA 9352 AF 07	800x600x450 h
Container height mm 325	
Capacity litres 130	

ORD. NO.	DIM. mm
F PA 9752 AF 07	800x600x555 h
Container height mm 430	
Capacity litres 175	



- The containers can be stacked thanks to the 4 feet which enter inside the container below



- The 2 connection pieces allow the containers to be stacked



- The containers can be stacked thanks to the 4 wheels which enter inside the container below

BLACK
F... ..07

KEY ■



Containers with this symbol are made of completely recyclable plastic material.

- Resistant to high and low temperatures



FOR STACKING CONTAINERS = 400x300 / 600x400 mm

SERIES STORAGE ESD ATHENA

KITTING TRAYS FOR STACKING CONTAINERS 400x300 / 600x400

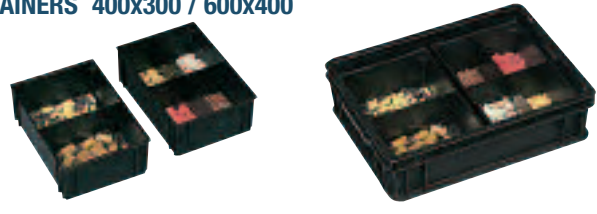

FOR STACKING CONTAINERS 400x300



■ 07

ORD. NO.	DIM. mm
F PP 4052 00 07	256x178x90 h
For containers	400x300
No. partitions	1

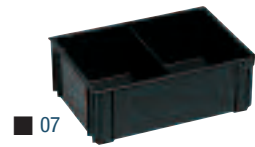

■ 07

ORD. NO.	DIM. mm
F PP 4552 00 07	256x178x90 h
For containers	400x300
No. partitions	2

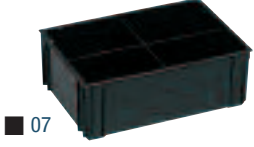

■ 07

ORD. NO.	DIM. mm
F PP 5052 00 07	256x178x90 h
For containers	400x300
No. partitions	4

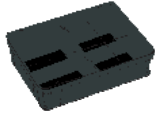
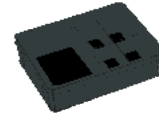
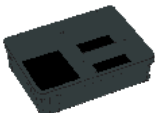
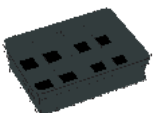
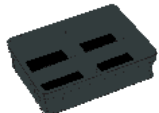
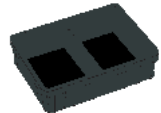

2 ORD. NO. F PP 4052 00 07 2 ORD. NO. F PP 4552 00 07 2 ORD. NO. F PP 5052 00 07 1 ORD. NO. F PP 4052 00 07 1 ORD. NO. F PP 4052 00 07 1 ORD. NO. F PP 4552 00 07
1 ORD. NO. F PP 4552 00 07 1 ORD. NO. F PP 5052 00 07 1 ORD. NO. F PP 5052 00 07

FOR STACKING CONTAINERS 600x400



■ 07

ORD. NO.	DIM. mm
F PP 6052 00 07	357x278x90 h
For containers	600x400
No. partitions	1

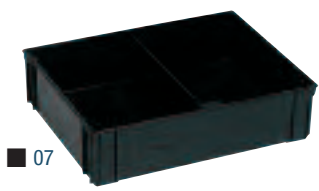

■ 07

ORD. NO.	DIM. mm
F PP 6552 00 07	357x278x90 h
For containers	600x400
No. partitions	2

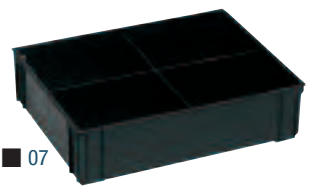

■ 07

ORD. NO.	DIM. mm
F PP 7052 00 07	357x278x90 h
For containers	600x400
No. partitions	4

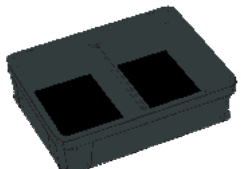

2 ORD. NO. F PP 6052 00 07

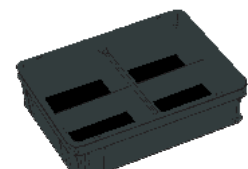

2 ORD. NO. F PP 6552 00 07

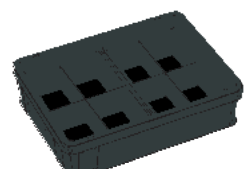

2 ORD. NO. F PP 7052 00 07

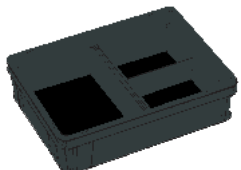

1 ORD. NO. F PP 6052 00 07
1 ORD. NO. F PP 6552 00 07

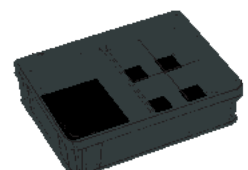

1 ORD. NO. F PP 6052 00 07
1 ORD. NO. F PP 7052 00 07

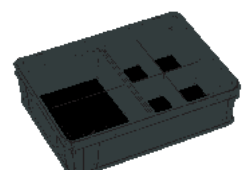

1 ORD. NO. F PP 6552 00 07
1 ORD. NO. F PP 7052 00 07

■ KEY



Containers with this symbol are made of completely recyclable plastic material.

■ Resistant to high and low temperatures

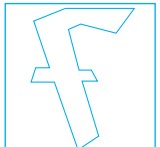

■ BLACK
F.....07

SERIES STORAGE ESD ATHENA

SLOTTED PARTITIONS

ORD. NO.	DIM. mm	INCREMENTS mm	FOR CONTAINERS SERIE
F HP 1320 00 07	255x45	20	400x300
F HP 1420 00 07	355x45	20	400x300 600x400
F HP 1620 00 07	555x45	20	600x400
F HP 1340 00 07	255x70	20	400x300
F HP 1440 00 07	355x70	20	400x300 600x400
F HP 1640 00 07	555x70	20	600x400
F HP 1350 00 07	255x90	20	400x300
F HP 1450 00 07	355x90	20	400x300 600x400
F HP 1650 00 07	555x90	20	600x400
F HP 1360 00 07	255x120	20	400x300
F HP 1460 00 07	355x120	20	400x300 600x400
F HP 1660 00 07	555x120	20	600x400
F HP 1370 00 07	255x180	20	400x300
F HP 1470 00 07	355x180	20	400x300 600x400
F HP 1670 00 07	555x180	20	600x400

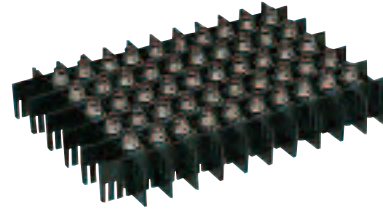

fitting the vertical dividers

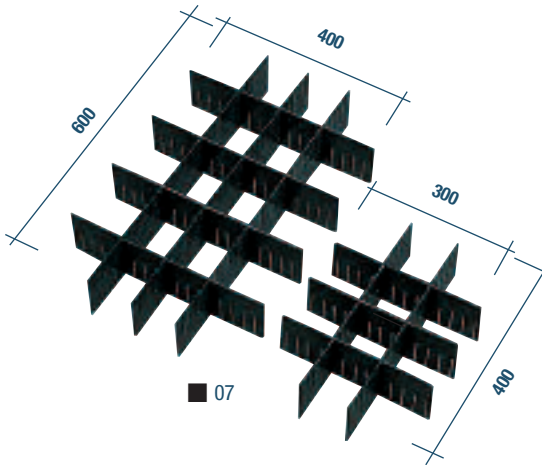

Order no. F HP 5130 00 07
Conductive intermediate shelf for containers series 400x300 mm 355x255

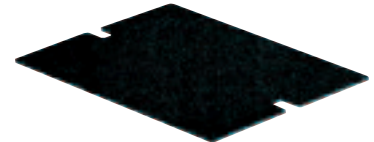

Order no. F HP 5140 00 07
Conductive intermediate shelf for containers series 600x400 mm 555x355

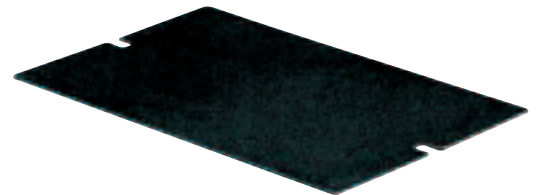

DIMPLE CIRCUIT BOARD HOLDER



ORD. NO.	DIM. MM
F PV 5752 00 07	355x255x14 h

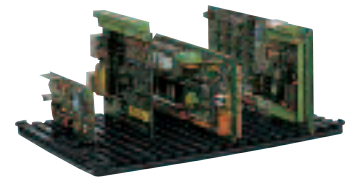

BLACK F. 07

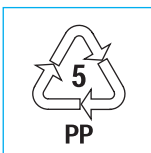
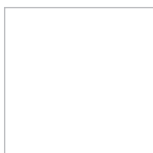
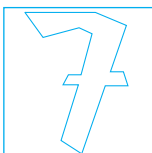

KEY ■

Containers with this symbol are made of completely recyclable plastic material.

■ Resistant to high and low temperatures



LABEL HOLDER



fitting the label holder



fitting the label holder



fitting the label



ORD. NO. F PZ 9551 00 07

Label holder

■ 07



ORD. NO. F PZ 9751 00 07

Label holder

■ 07

ORD. NO.	DIM. LABEL mm	LABEL ORD. NO.	FOR CONTAINER ORD. NO.
F PZ 9551 00 07	145x81	F PZ 0920 00 00	F PA 4452 A0 07 F PA 4852 A0 07 F PA 5252 A0 07
F PZ 9751 00 07	210x81	F PZ 0940 00 00	F PA 6452 A0 07 F PA 7652 A0 07

LID CATCHES



ORD. NO. F PZ 0681 00 13

Pair of lid catches.
Suitable for all containers
with exemption of the
ORD. NO. F PA 3652 A0 07



■ 99

ORD. NO. F PX 0910 00 99

Extension Assembly "U" Clip



■ 99

ORD. NO. F PZ 0010 00 99

Label clip

■ KEY



Containers with this symbol are made of completely recyclable plastic material.

■ Resistant to high and low temperatures



PP

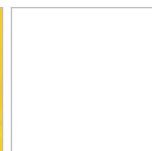

■ BLACK
F.....07

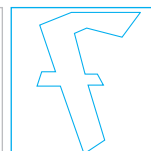

SERIES STORAGE ESD ZEUS - COMPAT

■ 07

**ORD. NO.**

CAPACITY LITRES

F PL 0952 00 07

0,25

External dim. mm 85/65x95x45 h

Internal dim. mm 63x90x43 h

Weight gr. 44

■ 07

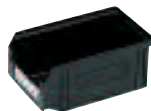
**ORD. NO.**

CAPACITY LITRES

F PM 1752 00 07

1

External dim. mm 160/140x95x75 h

Internal dim. mm 134x88x65 h

Weight gr. 100

■ 07

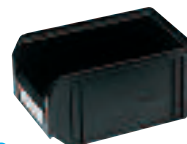
**ORD. NO.**

CAPACITY LITRES

F PM 2552 00 07

3,8

External dim. mm 230/200x140x130 h

Internal dim. mm 191x124x111 h

Weight gr. 340

■ 07

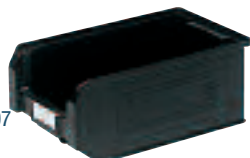
**ORD. NO.**

CAPACITY LITRES

F PM 3352 00 07

9,4

External dim. mm 350/300x200x145 h

Internal dim. mm 285x182x130 h

Weight gr. 650

■ 07

**ORD. NO.**

CAPACITY LITRES

F PM 4152 00 07

12,5

External dim. mm 350/300x200x200 h

Internal dim. mm 278x180x187 h

Weight gr. 890

■ 07

**ORD. NO.**

CAPACITY LITRES

F PM 5752 00 07

20

External dim. mm 500/450x300x145 h

Internal dim. mm 440x278x129 h

Weight gr. 1390

■ 07

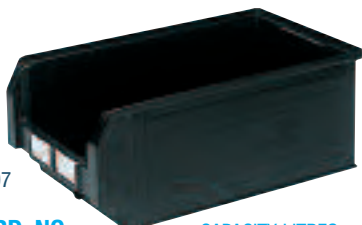
**ORD. NO.**

CAPACITY LITRES

F PM 6552 00 07

28

External dim. mm 500/450x300x200 h

Internal dim. mm 435x281x186 h

Weight gr. 1570

■ 07

**ORD. NO.**

CAPACITY LITRES

F PM 7352 00 07

42

External dim. mm 500/450x300x300 h

Internal dim. mm 432x280x287 h

Weight gr. 2120

■ 07

**ORD. NO.**

CAPACITY LITRES

F PJ 5752 00 07

16,2

External dim. mm 450x300x120 h

Internal dim. mm 426x275x106 h

Weight gr. 1010

■ 07

**ORD. NO.**

CAPACITY LITRES

F PJ 2552 00 07

3,6

External dim. mm 200x140x130 h

Internal dim. mm 186x125x110 h

Weight gr. 300

■ 07

**ORD. NO.**

CAPACITY LITRES

F PJ 3352 00 07

8,7

External dim. mm 300x200x145 h

Internal dim. mm 284x181x130 h

Weight gr. 570

■ 07

**ORD. NO.**

CAPACITY LITRES

F PJ 6552 00 07

27

External dim. mm 450x300x200 h

Internal dim. mm 428x277x183 h

Weight gr. 1430

LABELS

ORD. NO.

FOR STACKING AND STORAGE CONTAINERS ORD. NO.

DIM. SINGLE LABEL mm

NO. LABELS PER SHEET

F PL 9020 00 00

F PL 0952 00 07

49x11

80

F PL 9040 00 00

F PM 1752 00 07

75x20

35

F PL 9100 00 00

F PM 2552 00 07

104x33

16

F PL 9060 00 00

F PM 3352 00 07 / F PM 5752 00 07

77x31

18

F PL 9080 00 00

F PM 4152 00 07 / F PM 6552 00 07 / F PM 7352 00 07

77x42

12

F PL 9140 00 00

F PJ 5752 00 07

189x82

3

F PL 9160 00 00

F PJ 6552 00 07

189x85

3

KEY ■



Containers with this symbol are made of completely recyclable plastic material.

- Resistant to high and low temperatures

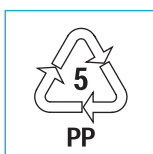
BLACK
F.....07

MULTIBOX BOXES SERIES F PK

The Multibox Series F PK boxes are manufactured in four different sizes and are available in black conductive polypropylene for the storage of sensitive electronic components. They are injection molded in a special conductive compound "FAMI 08 L" which has the characteristics to impede the formation of electrostatic charges or to discharge any charges already present (see page 6). The boxes are only available in a standard width of 160 mm and a height of 100 mm, but in 4 different depths: 300, 400, 500 and 650 mm. The design allows for the length of the box to be subdivided by removable partitions up to a maximum of 11 cells.

The boxes can be fitted with a handle which can provide a multitude of tasks.

1. Manual carrying.
2. Manual withdrawing from storage shelves.
3. Prevention of boxes falling out shelves when partially withdrawn.

The box front and partitions have space provided for the fitting of identification labels.

Partitions, handles and labels must all be ordered as separate item.



■ 07



■ 07



■ 07

ORD. NO.	DIM. mm
F PK 1052 00 07	300x160x100 h
External dim. mm	300x160x100 h
Internal dim. mm	260x135x89 h
Max q.ty of transversal dividers which can be inserted	4 pcs ord.no. F PK 7352 00 07

ORD. NO.	DIM. mm
F PK 2052 00 07	400x160x100 h
External dim. mm	400x160x100 h
Internal dim. mm	358x135x90 h
Max q.ty of transversal dividers which can be inserted	6 pcs ord.no. F PK 7352 00 07

ORD. NO.	DIM. mm
F PK 3552 00 07	500x160x100 h
External dim. mm	500x160x100 h
Internal dim. mm	460x135x89 h
Max q.ty of transversal dividers which can be inserted	8 pcs ord.no. F PK 7352 00 07



■ 07

ORD. NO.	DIM. mm
F PK 5052 00 07	650x160x100 h
External dim. mm	650x160x100 h
Internal dim. mm	610x135x89 h
Max q.ty of transversal dividers which can be inserted	11 pcs ord.no. F PK 7352 00 07

HANDLE



Handle dim. mm 120x80 h

ORD. NO.	F PK 6352 00 07
For boxes ord. no.	F PK 1052 00 07 F PK 2052 00 07 F PK 3552 00 07 F PK 5052 00 07

TRANSVERSAL DIVIDERS



Divider dim. mm 145x90 h

ORD. NO.	F PK 7352 00 07
For boxes ord. no.	F PK 1052 00 07 F PK 2052 00 07 F PK 3552 00 07 F PK 5052 00 07

LABELS FOR BOXES

ORD. NO.	FOR BOXES ORD. NO.	DIM. SINGLE LABEL mm	NO. LABELS PER SHEET
F PK 9580 00 00	F PK 1052 00 07 F PK 2052 00 07 F PK 3552 00 07 F PK 5052 00 07	121x44	8

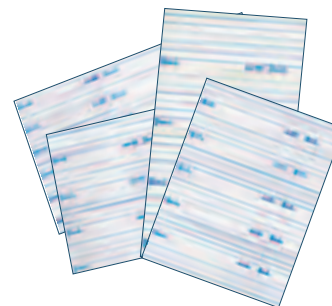

LABELS FOR DIVIDERS

ORD. NO.	FOR DIVIDERS ORD. NO.	DIM. SINGLE LABEL mm	NO. LABELS PER SHEET
F PK 9560 00 00	F PK 7352 00 07	121x24	16

■ KEY



Containers with this symbol are made of completely recyclable plastic material.

- Resistant to high and low temperatures

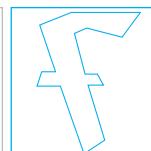
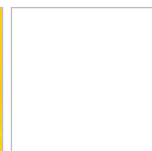

■ BLACK F.....07

SERIES STORAGE ESD

CUSTOMER PERSONALISING

The conductive stacking containers are excellent advertising vehicles given that the company logo can be hot printed in or relief moulded on one or more sides.



■ 07



hot foil printing

CONDUCTIVE FLOORING MATS

The special joining system of parts allows for easy assembly, to facilitate routine cleaning and maintenance programmes. These mats are particularly suitable to the electronics as well as the explosive manufacturing industries.

The material used is a conductive low density polyethylene.

Special features:

- Anti slip
- Easily cleaned
- Sound absorbing
- Soft
- Conductive

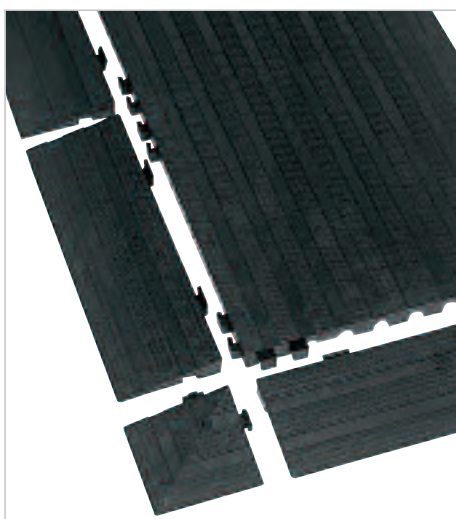

■ 07

closed top version

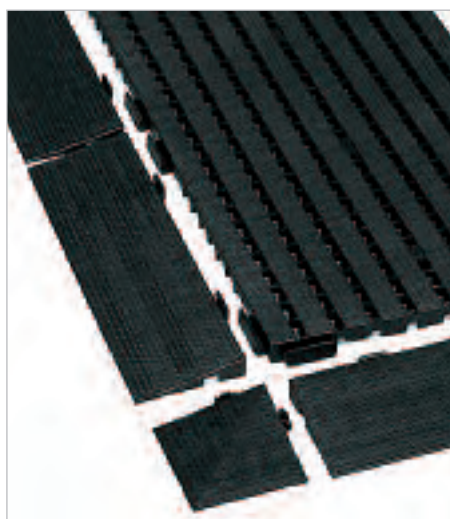

■ 07

open top version

ORD. NO.	DIM. mm	DESCRIPTION
F PX 1542 00 07	800x400x25	Mat
F PX 0242 00 07	400x120x25	Edge strip
F PX 0742 00 07	120x120x25	Corner piece

ORD. NO.	DIM. mm	DESCRIPTION
F PX 2542 00 07	800x400x25	Mat
F PX 0242 00 07	400x120x25	Edge strip
F PX 0742 00 07	120x120x25	Corner piece

■ BLACK
F. 07

INFO ■

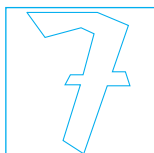

www.famispa.com



SERIES STORAGE ESD

■ P.C.B. HANDLING FRAME SYSTEM (MEGAPRINT® – MINIPRINT®)

A complete range of conductive products has been designed and produced by FAMI, in order to satisfy in a safe and logical manner all the problems of the electronics industry. Simplistic and modular designs characterise the FAMI products in this field, with actual solutions for the productions, storage, transportation, repair or maintenance of P.C.B.'s and various electronic components. For the manufacture of products, FAMI utilize conductive materials of top quality, which offers an ideal and total protection from electrostatic charges or mechanical damage. The FAMI card systems have been found to be ideal used in the sectors of electro/mechanical, electronics, mines as well as in the manufacturing of explosives.

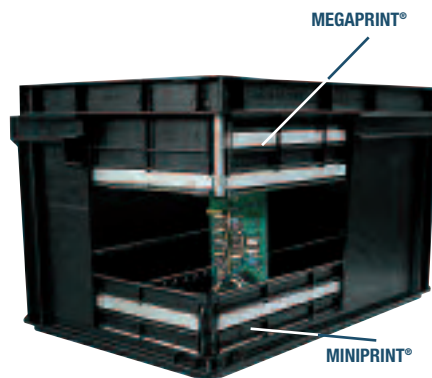
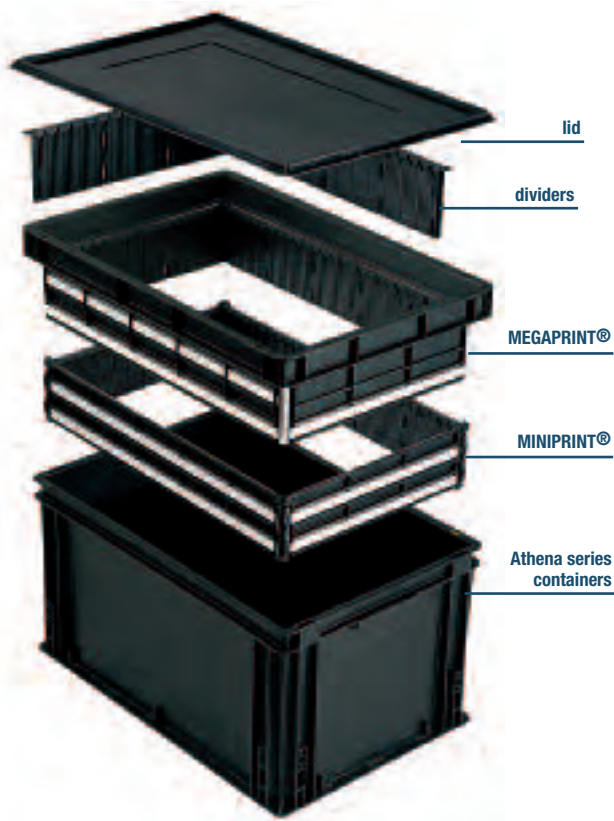

BLACK
 F. 07

KEY ■

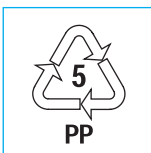
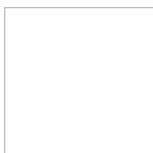
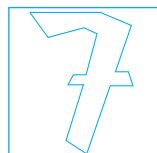

Containers with this symbol are made of completely recyclable plastic material.

- Resistant to high and low temperatures

TABLE OF SUB-DIVISIONS

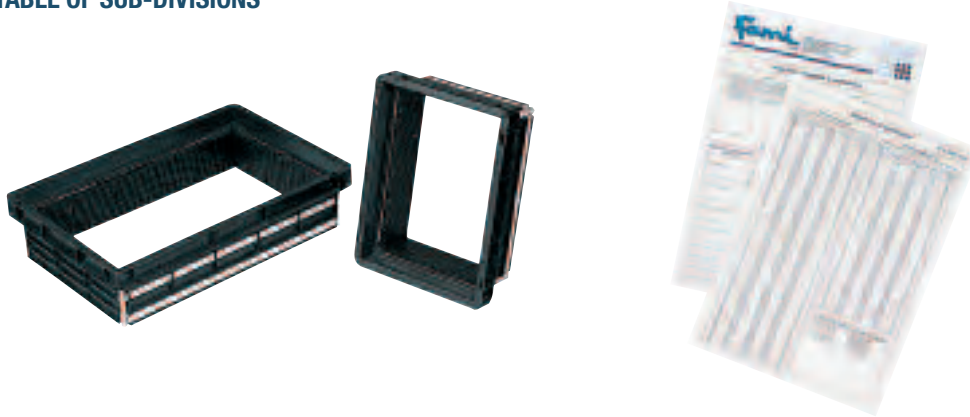

In the Megaprint® and Miniprint® systems, the choice of the type of divider comes about most easily and quickly if one consults the recommended table of sub-divisions. This determines the insertion point of the divider to the size of the P.C.B. to be inserted.

DIVIDERS



Technical specifications of standard system	
■ Width of channels	.2,5 mm
■ Depth of channels	.3,0 mm
■ Pitch of channels	.5,08 mm
■ Minimum sub-division of the system	.1,7 mm

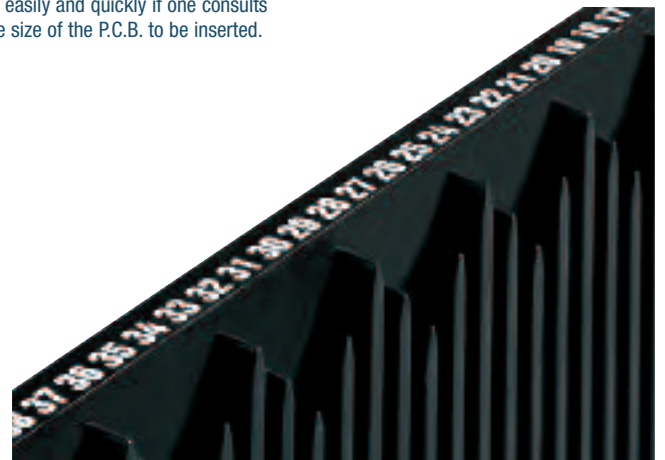

To simplify the insertion of dividers and P.C.B.'s in the Megaprint® and Miniprint® systems, each of the channels are identified numerically. Each channel is referred to by a number which corresponds exactly to the number of the channel opposite.

The sub-division of the Megaprint® and Miniprint® system is perfectly adaptable to the wide spread of sizes of P.C.B.'s, particularly as the sub-dividers have been designed in three variants. The variants are as follows:

- normal distance divider
- minus distance divider
- plus distance divider.

With this system one can vary the distance between dividers by a pitch of 1.7 mm.

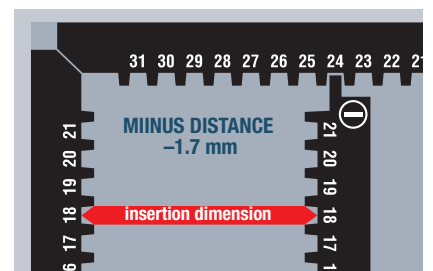
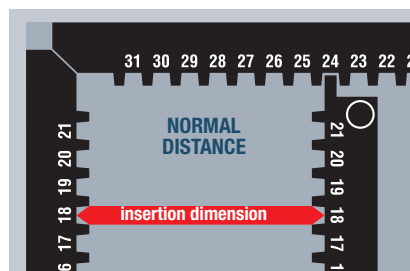
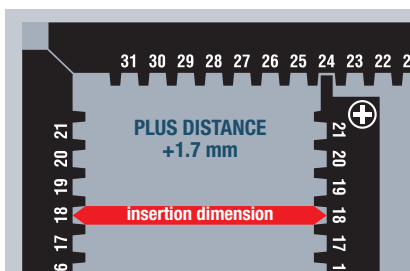

KEY



Containers with this symbol are made of completely recyclable plastic material.

- Resistant to high and low temperatures

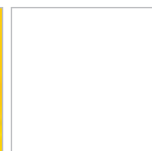

BLACK
F.....07

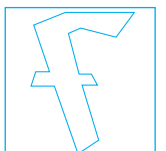

SERIES STORAGE ESD

MEGAPRINT® 400x300

The FAMI Megaprint® system 400x300, in the field of production and storage of electronic P.C.B.'s, is held to be the leader in the sector. The system itself has been designed and produced to especially satisfy the work cycle of P.C.B. production, from their design stage to final production. The system is comprised of four rigid walls attached to themselves by reinforced aluminium profiles on their external faces, hence they remains straight and robust.

On the internal faces are moulded precision channels which are used to edge locate P.C.B.'s.

The design of the system is such that, using the sub-dividers, it can be infinitely adjusted to accommodate P.C.B.'s with a dimension less than 235 mm.

The Megaprint® 400x300 is clipped onto the top frame of the 400x300 mm series standard containers.

Technical specifications of standard system

- Width of channels 2,5 mm
- Depth of channels 3,0 mm
- Pitch of channels 5,08 mm
- Minimum sub-division of the system .1,7 mm



■ 07

ORD. NO.	EXTERNAL dimensions mm	INTERNAL dimensions mm	CHANNELS			MINIMUM SUB-DIVISION of the system mm	SLOT pitches	FITS container
			width mm	depth mm	pitch mm			
F PV 7752 00 07	400x300x140	335x235x140	2,5	3,0	5,08	1,7	4 walls of 5,08 mm	F PA 4052 A0 07 F PA 4452 A0 07 F PA 4852 A0 07 F PA 5252 A0 07

MINIPRINT® 400x300

The Miniprint® system 400x300 has the same typical characteristics as the Megaprint® system, with the particular characteristic that it can be inserted completely into the conductive FAMI containers of size 400x300 mm and is adopted for the use with P.C.B.'s with a dimension less than 235 mm.

For cards which are especially long the Miniprint® system is used in conjunction with the Megaprint® system. The joining of the two systems provides a longer channel, therefore greater security of the inserted P.C.B. is given.

Technical specifications of standard system

- Width of channels 2,5 mm
- Depth of channels 3,0 mm
- Pitch of channels 5,08 mm
- Minimum sub-division of the system .1,7 mm

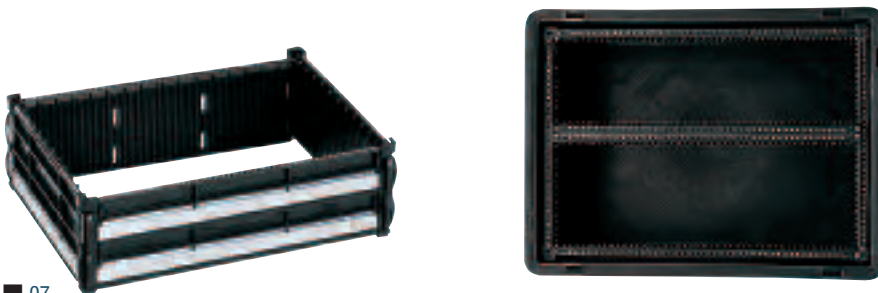

■ 07

ORD. NO.	EXTERNAL dimensions mm	INTERNAL dimensions mm	CHANNELS			MINIMUM SUB-DIVISION of the system mm	SLOT pitches	FITS container
			width mm	depth mm	pitch mm			
F PV 7252 00 07	360x260x98	335x235x98	2,5	3,0	5,08	1,7	4 walls of 5,08 mm	F PA 4052 A0 07 F PA 4452 A0 07 F PA 4852 A0 07 F PA 5252 A0 07

■ BLACK
F.....07

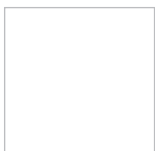
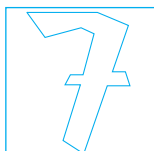

KEY ■



Containers with this symbol are made of completely recyclable plastic material.

- Resistant to high and low temperatures



THE USE OF MEGAPRINT® ADDS 44 mm THE CONTAINER HEIGHT OVERALL

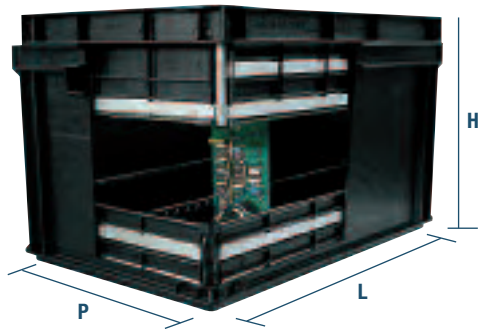

ORD. NO.	OVERALL DIMENSIONS containers + Megaprint® mm	BOARD CAPACITY width mm	INSERTION depth mm
F PA 4052 A0 07	400x300x164	235	150
F PA 4852 A0 07	400x300x264	235	250
F PA 5252 A0 07	400x300x369	235	355

An example of using a Megaprint® in conjunction with a Miniprint® system for P.C.B.'s which are especially long, is shown by using both systems for additional support.

DIVIDERS FOR 400x300

The Megaprint® and Miniprint® systems can be sub-divided in a logical and precise manner using a series of sub-dividers with a special characteristics. These allow the complete and flexible utilization of the system, because any P.C.B., which is smaller than the container itself can be accommodated. The dividers are available with three variants which allow a minimum pitch between sub-dividers of 1.7 mm. The three variants are normal, minus and plus distance. The construction of the dividers is robust and reinforced in profile with aluminium ribs.

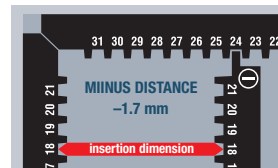
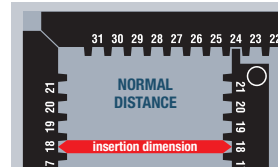
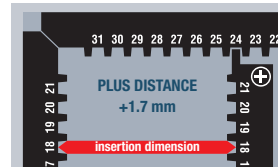
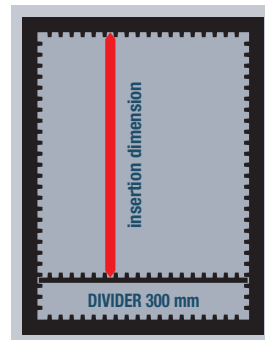
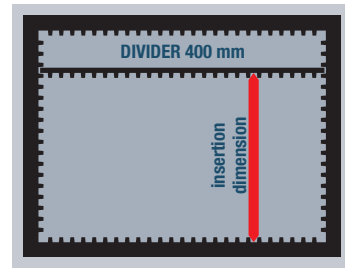
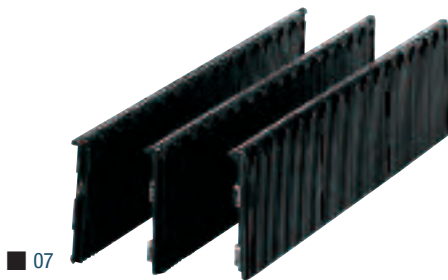

ORD. NO.	DISTANCE	DIVIDER for mm	EXTERNAL DIM. mm
F PV 0752 00 07	minus	400	335x98
F PV 0852 00 07	normal	400	335x98
F PV 0952 00 07	plus	400	335x98

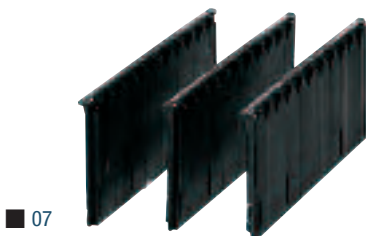

ORD. NO.	DISTANCE	DIVIDER for mm	EXTERNAL DIM. mm
F PV 0252 00 07	minus	300	235x98
F PV 0352 00 07	normal	300	235x98
F PV 0452 00 07	plus	300	235x98

KEY



Containers with this symbol are made of completely recyclable plastic material.

Resistant to high and low temperatures

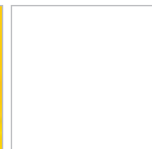

BLACK
F.....07

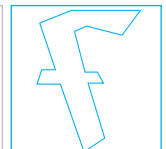

SERIES STORAGE ESD

MEGAPRINT® 600x400

The FAMI Megaprint® 600x400 system has technical characteristics equal to the system MP 400x300, and is adopted for the use with P.C.B.'s with a dimension less than 535 mm.

It is insertable in the FAMI conductive container system Athena, with a dimensions of 600x400 mm in various heights.

Technical specifications of standard system

- Width of channels2,5 mm
- Depth of channels3,0 mm
- Pitch of channels5,08 mm
- Minimum sub-division of the system .1,7 mm

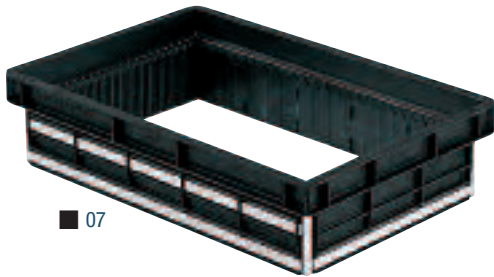

ORD. NO.	EXTERNAL dimensions mm	INTERNAL dimensions mm	CHANNELS			MINIMUM SUB-DIVISION of the system mm	SLOT pitches	FITS container
			width mm	depth mm	pitch mm			
F PV 7952 00 07	600x400x140	535x335x140	2,5	3,0	5,08	1,7	4 walls of 5,08 mm	F PA 6052 A0 07 F PA 6452 A0 07 F PA 6852 A0 07 F PA 7652 A0 07 F PA 8052 B0 07

MINIPRINT® 600x400

The FAMI Miniprint® 600x400 system has technical characteristics equal to the system MP 400x300, and is adopted for the use with P.C.B.'s with a dimension less than 535 mm.

This system also finds applications using the FAMI conductive container system Athena with dimensions of 600x400 mm with the various heights.

Technical specifications of standard system

- Width of channels2,5 mm
- Depth of channels3,0 mm
- Pitch of channels5,08 mm
- Minimum sub-division of the system .1,7 mm



ORD. NO.	EXTERNAL dimensions mm	INTERNAL dimensions mm	CHANNELS			MINIMUM SUB-DIVISION of the system mm	SLOT pitches	FITS container
			width mm	depth mm	pitch mm			
F PV 7452 00 07	560x360x98	535x335x98	2,5	3,0	5,08	1,7	4 walls of 5,08 mm	F PA 6052 A0 07 F PA 6452 A0 07 F PA 6852 A0 07 F PA 7652 A0 07 F PA 8052 B0 07

BLACK
F.07

KEY ■

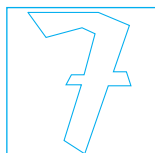

Containers with this symbol are made of completely recyclable plastic material.

- Resistant to high and low temperatures

THE USE OF MEGAPRINT® ADDS 44 mm THE CONTAINER HEIGHT OVERALL

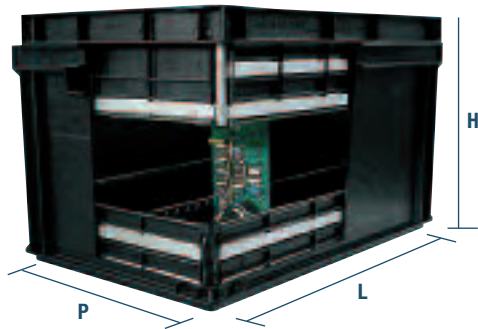

ORD. NO.	OVERALL DIMENSIONS containers + Megaprint® mm	BOARD CAPACITY width mm	INSERTION depth mm
F PB 6852 A0 07	600x400x264	535	250
F PA 7652 A0 07	600x400x369	535	355
F PA 8052 B0 07	600x400x474	535	455

An example of using a Megaprint® in conjunction with a Miniprint® system for P.C.B.'s which are especially long, is shown by using both systems for additional support.

DIVIDERS FOR 600x400

The Megaprint® and Miniprint® systems can be sub-divided in a logical and precise manner using a series of sub-dividers with a special characteristics. These allow the complete and flexible utilization of the system, because any P.C.B., which is smaller than the container itself can be accommodated. The dividers are available with three variants which allow a minimum pitch between sub-dividers of 1.7 mm. The three variants are normal, minus and plus distance. The construction of the dividers is robust and reinforced in profile with aluminium ribs.

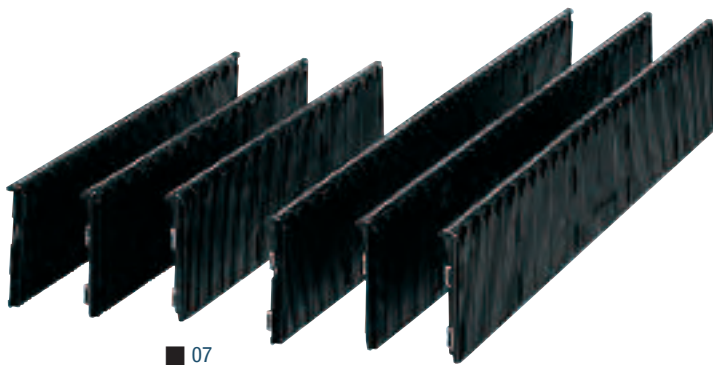
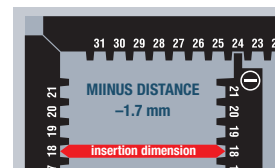
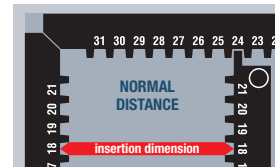
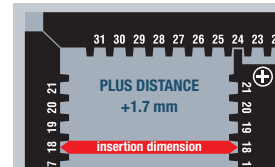
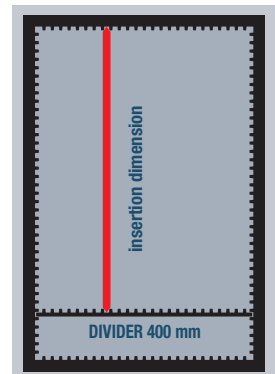
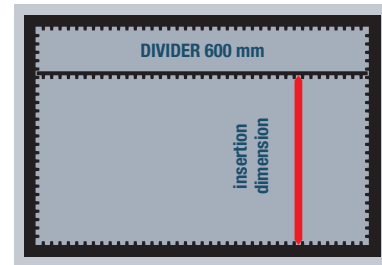

07

ORD. NO.	DISTANCE	DIVIDER for mm	EXTERNAL DIM. mm
F PV 0752 00 07	minus	400	335x98
F PV 0852 00 07	normal	400	335x98
F PV 0952 00 07	plus	400	335x98

ORD. NO.	DISTANCE	DIVIDER for mm	EXTERNAL DIM. mm
F PV 1752 00 07	minus	600	535x98
F PV 1852 00 07	normal	600	535x98
F PV 1952 00 07	plus	600	535x98

KEY



Containers with this symbol are made of completely recyclable plastic material.

- Resistant to high and low temperatures

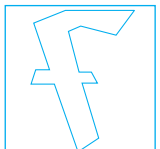
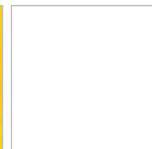

BLACK
F.....07

SERIES STORAGE ESD

■ ROBOTIC SPACING SYSTEM

The proven characteristics of the Megaprint® System has been further advanced by the introduction of a Robotic handling version. This system has been designed for use on fully Robotic automated systems and also to dramatically improve insertion time when used in high volume manual production environments.

Technical specification of robotic system

- Width of channels 3,5 mm
- Depth of channels 3,0 mm
- Pitch of channels 15,24 mm
- Minimum sub-division of the system .1,7 mm

Insertion points have increased angled lead ins to improve P.C.B. insertion.

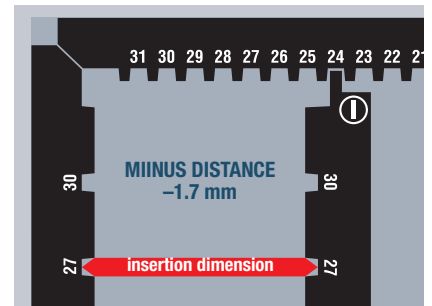
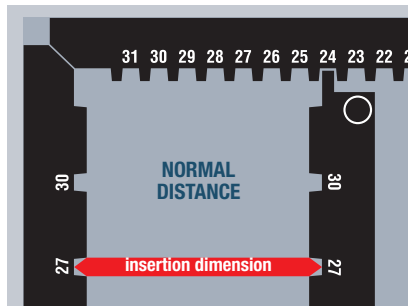
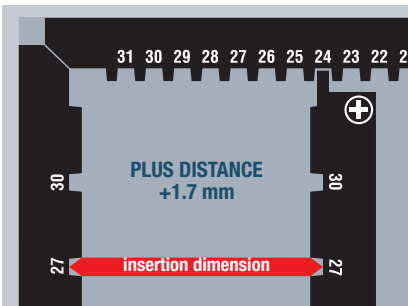
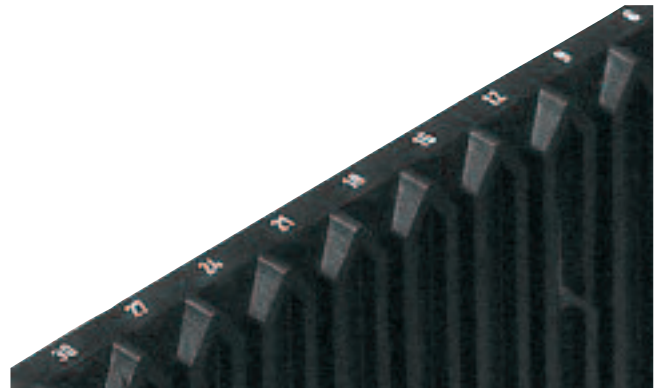

BLACK
F. 07

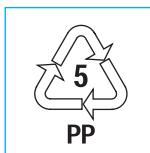
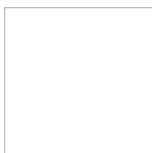
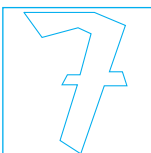

KEY ■



Containers with this symbol are made of completely recyclable plastic material.

- Resistant to high and low temperatures



ROBOTIC SPACING SYSTEM

SERIES STORAGE ESD

MEGAPRINT® / MINIPRINT® – 400x300

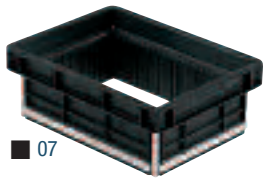

■ 07

MEGAPRINT® 400x300
ORD. NO. F PV 8752 00 07

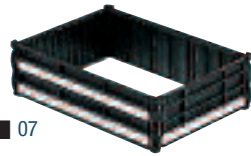

■ 07

MINIPRINT® 400x300
ORD. NO. F PV 8252 00 07

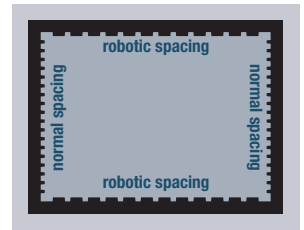

ORD. NO.	EXTERNAL dimensions mm	INTERNAL dimensions mm	CHANNELS			MINIMUM SUB-DIVISION of the system mm	SLOT pitches	FITS container
			width mm	depth mm	pitch mm			
F PV 8752 00 07 Megaprint® robotic	400x300x140	335x235x140	3,5	3,0	15,24	1,7	2 walls of 5,08 mm	F PA 4052 A0 07 F PA 4452 A0 07 F PA 4852 A0 07
F PV 8252 00 07 Miniprint® robotic	360x260x98	335x235x98					2 walls of 15,24 mm	F PA 5252 A0 07

MEGAPRINT® / MINIPRINT® – 600x400

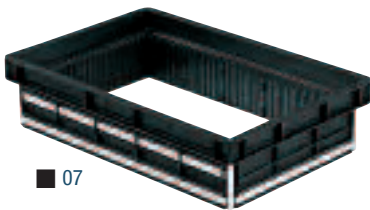

■ 07

MEGAPRINT® 600x400
ORD. NO. F PV 8952 00 07

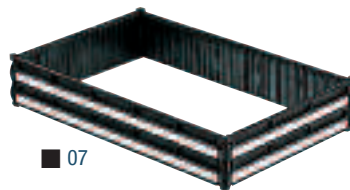

■ 07

MINIPRINT® 600x400
ORD. NO. F PV 8452 00 07

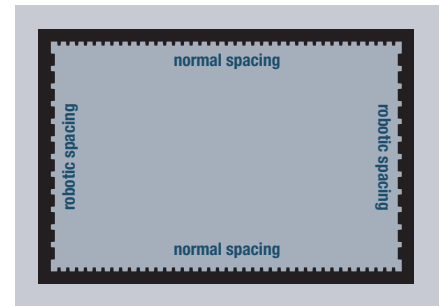

ORD. NO.	EXTERNAL dimensions mm	INTERNAL dimensions mm	CHANNELS			MINIMUM SUB-DIVISION of the system mm	SLOT pitches	FITS container
			width mm	depth mm	pitch mm			
F PV 8952 00 07 Megaprint® robotic	600x400x140	535x335x140	3,5	3,0	15,24	1,7	2 walls of 5,08 mm	F PA 6052 A0 07 F PA 6452 A0 07 F PB 6852 A0 07
F PV 8452 00 07 Miniprint® robotic	560x360x98	535x335x98					2 walls of 15,24 mm	F PA 7652 A0 07 F PA 8052 B0 07

DIVIDERS ROBOTIC

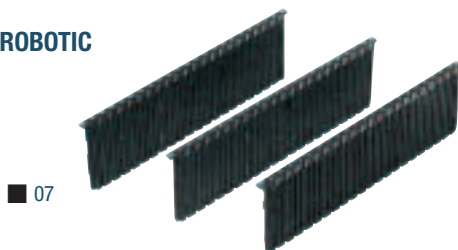

■ 07

ORD. NO.	DISTANCE	DIVIDER for mm	EXTERNAL DIM. mm
F PV 2252 00 07	minus	400	335x98
F PV 2352 00 07	normal	400	335x98
F PV 2452 00 07	plus	400	335x98

■ KEY



Containers with this symbol are made of completely recyclable plastic material.

■ Resistant to high and low temperatures

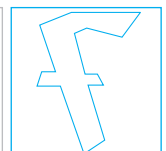
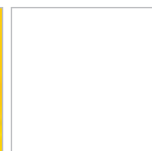

■ BLACK
F.....07

SERIES STORAGE ESD

CARD CARRYING SYSTEM

The card carrying frames make up an integral part of the FAMI P.C.B. carrying systems, and are used in the production, storage and transportation of P.C.B.'s. They are formed essentially of two lateral walls and a central fixed wall between them and aluminium guides. These frames can be used either inserted in the containers or else as a totally independent system. Apart from the standardized container insertion dimensions, the system can give the possibility, dependant upon the length of the guides, to have more variable measurements. The frame can be used in a vertical, horizontal or flat position, and they can be stacked providing they are of equal dimensions. Also if the frame is compatible, the precision of the solution is such as to permit the use in either manual or robotic application.



PAIR OF ALLUMINIUM GUIDES

ORD. NO.	DIM. mm
F PV 9110 00 00	152x53
F PV 9120 00 00	252x53
F PV 9140 00 00	352x53
F PV 9160 00 00	552x53



Our Card carries provide an excellent edge mounting system for handling circuit boards. Made from injection moulded conductive co-polymer polypropylene with electrical value of $10^4 \Omega/1$, they can be used in contact with the majority of solvents and to a temperature 100 °C. The unique flexibility of the clamping system, allow the re-inforced card guides to move over the entire length of the side aluminium guide rails.

FRAME COMPLETE WITH FASTENERS

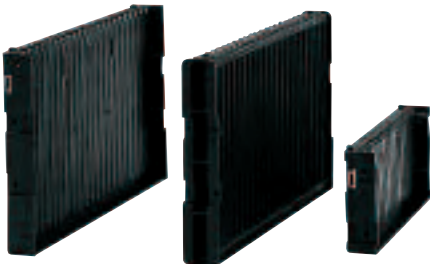

ORD. NO.
F PV 6452 00 07
Side frames

ORD. NO.
F PV 6852 00 07
Central frames

ORD. NO.
F PV 6252 00 07
Side frames



ORD. NO.
F PV 9010 00 07
Fastener complete of
screws and nuts

ORD. NO.	DIM. mm	CHANNELS			
		number	width mm	depth mm	pitch mm
F PV 6452 00 07	350x30x190	22	2,5	3,0	15,3
F PV 6852 00 07	350x35x190	22+22	2,5	3,0	15,3
F PV 6252 00 07	250x30x95	15	2,5	3,0	15,3



details of side frames



details of fastener



fitting the frame



shifting the central divider

BLACK
F. 07

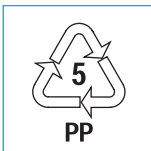
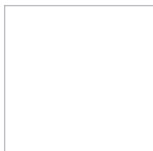
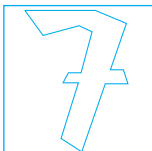

KEY ■



Containers with this symbol are made of completely recyclable plastic material.

- Resistant to high and low temperatures

EXAMPLE OF CARD CARRYING FRAME SYSTEM

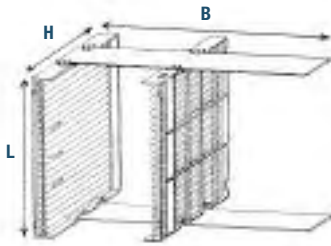

F PV 9110 01 00, F PV 9140 01 00, F PV 9120 01 00 and F PV 9160 01 00

All card guides have as standard a re-inforcing aluminium rail for extra rigidity. The slot profile in the card guides is 2.5 mm wide and 3.0 mm deep on a 15.3 mm pitch. Each card guide also has a moulded in slot numbering system, to ensure correct location of cards, and an integral base stop.

All components can be purchased separately and the aluminium rails can be supplied in lengths up to 1.5 m to provide flexibility in designing a system to suit your manufacturing requirements.

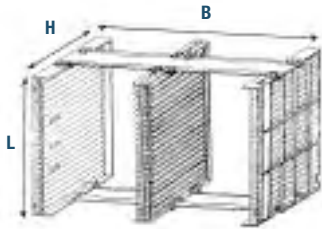

F PV 9120 02 00 and F PV 9160 02 00

This system provides the same low cost solutions as the models F PV 9110 01 00, F PV 9140 01 00, F PV 9120 01 00 and F PV 9160 01 00 but has the double-sided centre card guide incorporated. Since the centre panel (Order no. F PV 6852 00 07) is double-sided, it allows for extra capacity without the loss of space associated with other systems which need to use two single card guides to achieve the same result. Standard Conductive Container's for storage of these card carriers are available in varying depths to suit different models of carrier.

ORD. NO.	OVERALL dim. mm	P.C.B. CAPACITY maximum mm	P.C.B. slot	FITS into container	UTILIZED STANDARD FAMI P.C.B. card	guide rails
F PV 9110 01 00	250x150x95	135x105	15	F PA 2452 A0 07	2x F PV 6252 00 07	1x F PV 9110 00 00 150 mm
F PV 9140 01 00	250x350x95	335x150	15	F PA 4052 A0 07 F PA 4452 A0 07	2x F PV 6252 00 07	1x F PV 9140 00 00 350 mm
F PV 9120 01 00	350x250x190	235x300	21	F PA 4852 A0 07 F PA 5252 A0 07	2x F PV 6452 00 07	1x F PV 9120 00 00 250 mm
F PV 9160 01 00	350x550x190	535x400	21	F PB 6852 A0 07 F PA 7652 A0 07 F PA 8052 B0 07	2x F PV 6452 00 07	1x F PV 9160 00 00 550 mm
F PV 9120 02 00	350x250x190	95x300	42	F PA 4852 A0 07 F PA 5252 A0 07	2x F PV 6452 00 07 1x F PV 6852 00 07	1x F PV 9120 00 00 250 mm
F PV 9160 02 00	350x550x190	2545x400	42	F PB 6852 A0 07 F PA 7652 A0 07 F PA 8052 B0 07	2x F PV 6452 00 07 1x F PV 6852 00 07	1x F PV 9160 00 00 550 mm

The card carrying frames used in conjunction with Athena conductive containers, 600x400 and 400x300 mm.



frame in a horizontal position



frame in a vertical position

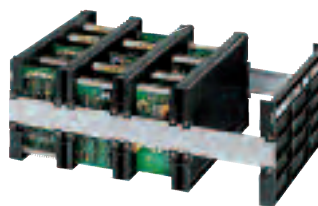

frame in a flat position



KEY



Containers with this symbol are made of completely recyclable plastic material.

■ Resistant to high and low temperatures

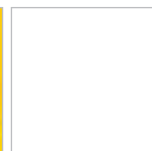

BLACK F... 07

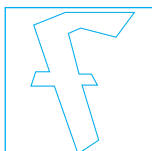

SERIES STORAGE MAT

■ EXCELLENT ADHERENCE TO THE FLOOR

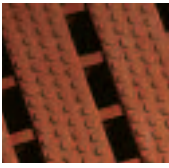

The special relief pattern on the surface guarantees maximum adherence, even in wet conditions.



The non-slip matting can cover electrical cables running along the floor in perfect safety.

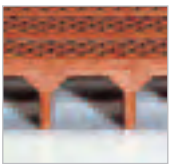

The special structure of the matting is designed to withstand heavy loads.



Connection clamps and chamfered corner pieces increase operator safety with trolley, help wheels run more smoothly and improve the appearance of the matting.



All the parts can be fitted together and removed thanks to a special connection system.





GREY
F. 01

BRICK RED
F. 06

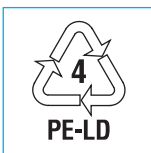
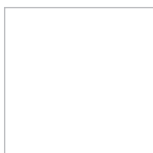
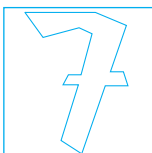
KEY ■



 The non-slip mattings are made of completely recyclable plastic material. 

DIMENSIONS = 800x400 mm

SOLID NON-SLIP MATTING



ORD. NO.	DIM. mm
F PX 1541 00 01	800x400x25 h
F PX 1541 00 06	



PERFORATED NON-SLIP MATTING

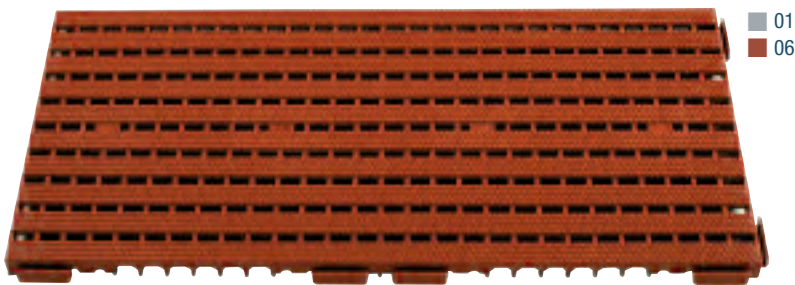

ORD. NO.	DIM. mm
F PX 2541 00 01	800x400x25 h
F PX 2541 00 06	



EDGING PIECE



ORD. NO. F PX 0241 00 05
Dimensions mm 400x120

CORNER PIECE



ORD. NO. F PX 0741 00 05
Dimensions mm 120x120

GALVANISED CLIPS



ORD. NO. F PX 0910 00 99

KEY

BRICK RED
F. 06

GREY
F. 01

YELLOW
F. 05

GALVANISED
F. 99



The non-slip mattings are made of completely recyclable plastic material.

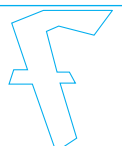

SERIES STORAGE BIG STEEL

- SEVERAL TYPES AVAILABLE
- STRONG

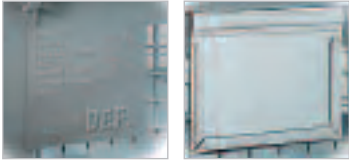

The metal containers can be fitted with label holders, to connect to the edge, or with relief printed load capacity plates to weld in the position requested by the customer.

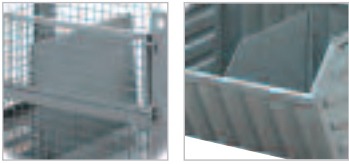

The insides of the containers can be divided into various compartments thanks to the practical dividers in painted sheet metal.



SHEET STEEL PALLETS

Made from painted sheet steel, these pallets are perfect for handling material with forklift trucks and feature greater load capacity and longer lifetime than traditional wooden pallets.

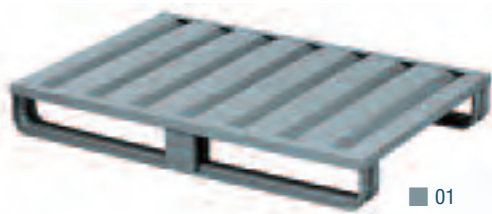

ORD. NO.	DIM. mm
F ML 0610 00 01	1000x800x155 h
F ML 0620 00 01	1200x800x155 h

- Evenly distributed weight load capacity 2000 kg*

*Load has been calculated with the pallet laying on a regular surface

PLASTIC PALLETS

Constructed in high density polyethylene, designed to guarantee maximum resistance to intensive operating stress. Extremely useful for the transport of palletizable goods, especially lightweight and easy to handle, suitable for all requirements in load handling. Pallets are totally washable, thus guaranteeing maximum hygiene.



ORD. NO.	DIM. mm
F PU 2040 00 13	1200x800x150 h
F PU 3040 00 13	1200x1000x150 h

SHEET METAL CONTAINERS



with half side open



ORD. NO.	LOAD CAPACITY kg	DIM. mm
F ML 0321 00 01	700	800x500x600 h

ORD. NO.	LOAD CAPACITY kg	DIM. mm
F ML 0320 00 01	700	800x500x600 h

RAL 7000
F.....01

KEY ■

- For further information on containers and pallets see catalogue no. 600 section L.



LENGTH = 800 / 1000 / 1200 mm

SERIES STORAGE BIG STEEL

WIDE - MOUTHED CONTAINERS



■ 01 ■ 99

ORD. NO.	LOAD CAPACITY kg	DIM. mm
F ML 0510 00 01	1000	800x700x600 h

MESH CONTAINERS



■ 01

ORD. NO.	LOAD CAPACITY kg	DIM. mm	MESH HOLES DIM.
F MM 0400 00 01	1000	1000x800x800 h	60x30 mm
F MM 0410 00 01	1500	1000x800x800 h	40x40 mm

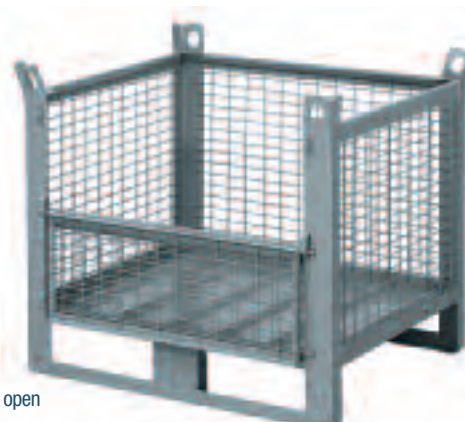

with half side open

■ 01

ORD. NO.	LOAD CAPACITY kg	DIM. mm	MESH HOLES DIM.
F MM 0401 00 01	1000	1000x800x800 h	60x30 mm
F MM 0411 00 01	1500	1000x800x800 h	40x40 mm



■ 01

ORD. NO.	LOAD CAPACITY kg	DIM. mm	MESH HOLES DIM.
F MM 0420 00 01	1000	1200x800x800 h	60x30 mm
F MM 0430 00 01	1500	1200x800x800 h	40x40 mm

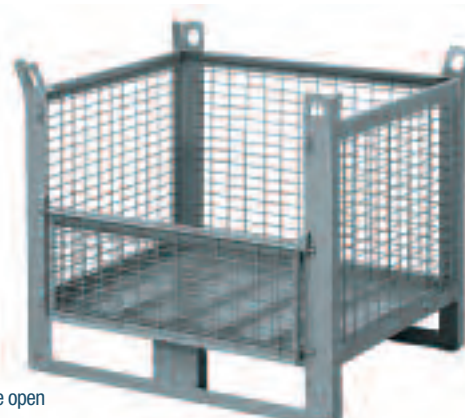

with half side open

■ 01

ORD. NO.	LOAD CAPACITY kg	DIM. mm	MESH HOLES DIM.
F MM 0421 00 01	1000	1200x800x800 h	60x30 mm
F MM 0431 00 01	1500	1200x800x800 h	40x40 mm

■ KEY



■ For further information on containers and pallets see catalogue no. 600 section L.

■ GREY
F.....01

■ GALVANISED
F.....99



SERIES STORAGE BIG STEEL

LENGTH = 1000 / 1200 / 1500 mm

COLLAPSIBLE CONTAINERS

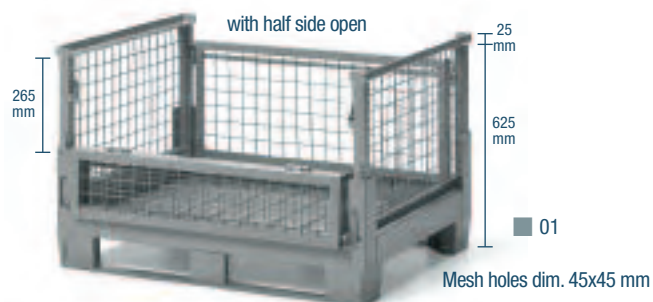

ORD. NO.	LOAD CAPACITY kg	OVERALL DIM. mm
F MM 2401 00 01	1200	1000x800x650 h
Internal dim. mm 905x715x455/500 h		
Overall collapsed dimensions mm 1000x800x354 h		

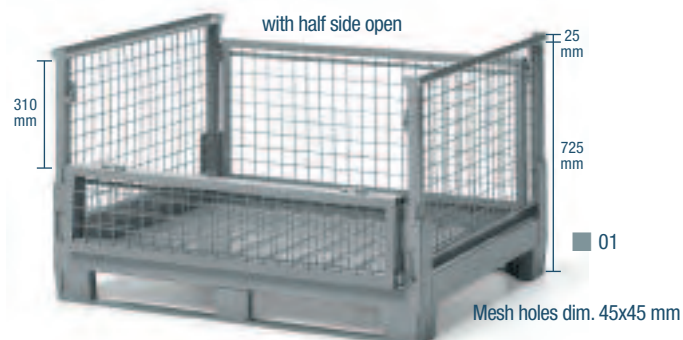

ORD. NO.	LOAD CAPACITY kg	OVERALL DIM. mm
F MM 2571 00 01	1200	1200x1000x750 h
Internal dim. mm 1100x915x555/600 h		
Overall collapsed dimensions mm 1200x1000x354 h		

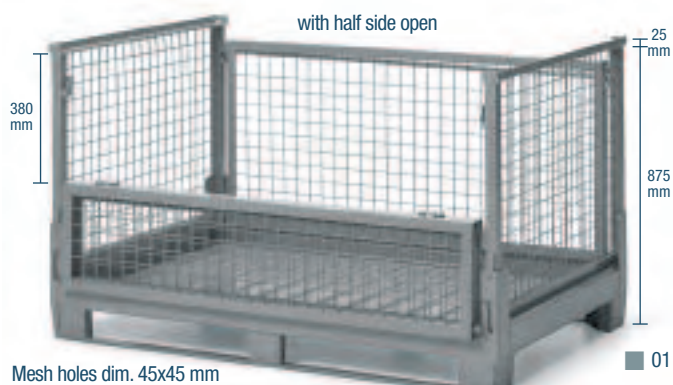

ORD. NO.	LOAD CAPACITY kg	OVERALL DIM. mm
F MM 2671 00 01	1200	1500x1000x900 h
Internal dim. mm 1400x915x705/750 h		
Overall collapsed dimensions mm 1500x1000x354 h		

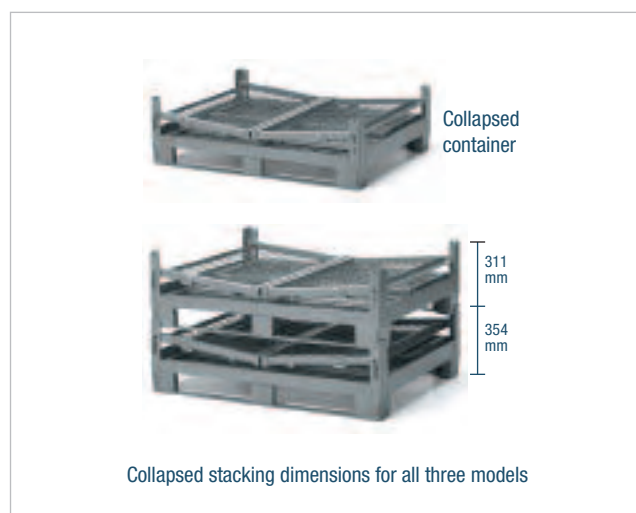
GREY
F. 01

KEY ■

- The 3-basket container must be wall-mounted (compulsory)



MOBILE PARTITIONS FOR CONTAINERS



■ 01

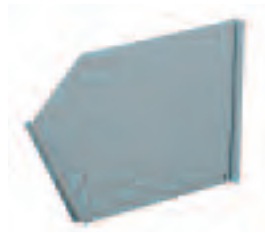

■ 01 ■ 99

ORD. NO.

DIM. mm

F MM 0710 00 01**225x760x505 h**

Suitable for ORD. NO.:

F MM 0400 - F MM 0401 - F MM 0410 - F MM 0411 -
F MM 0430 - F MM 0431

ORD. NO.

DIM. mm

F ML 0710 00 01**630/460x405 h**

Suitable for ORD. NO.:

F ML 0510

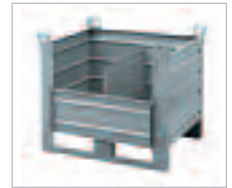

Example of using partitions



■ INFO

www.famispa.com

 ■ GREY
F.....01

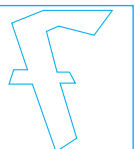
 ■ GALVANISED
F.....99

SERIES STORAGE BIG STEEL

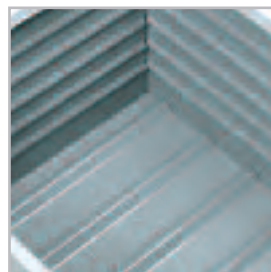

Detail of bottom

SHEET METAL CONTAINERS HEIGHT 690 mm



ORD. NO.	LOAD CAPACITY kg	OVERALL DIM. mm
F ML 0430 00 01	1500	1000x800x690 h



ORD. NO.	LOAD CAPACITY kg	OVERALL DIM. mm
F ML 0431 00 01	1500	1000x800x690 h

SHEET METAL CONTAINERS HEIGHT 670 mm



ORD. NO.	LOAD CAPACITY kg	OVERALL DIM. mm
F ML 0330 00 01	600	1000x800x690 h



ORD. NO.	LOAD CAPACITY kg	OVERALL DIM. mm
F ML 0420 00 01	2000	1000x800x670 h

GREY
F. 01

INFO ■



■ Dividers see page G97

www.famispa.com



WIDTH = 1000 / 1200 mm DEPTH = 800 mm

SERIES STORAGE BIG STEEL

SHEET METAL CONTAINERS HEIGHT 800 mm



ORD. NO.	LOAD CAPACITY kg	OVERALL DIM. mm
F ML 0440 00 01	1500	1000x800x800 h



ORD. NO.	LOAD CAPACITY kg	OVERALL DIM. mm
F ML 0441 00 01	1500	1000x800x800 h

SHEET METAL CONTAINERS HEIGHT 800 mm



ORD. NO.	LOAD CAPACITY kg	OVERALL DIM. mm
F ML 0450 00 01	1500	1200x800x690 h



ORD. NO.	LOAD CAPACITY kg	OVERALL DIM. mm
F ML 0451 00 01	1500	1200x800x690 h



ORD. NO.	LOAD CAPACITY kg	OVERALL DIM. mm
F ML 0461 00 01	1500	1200x800x800 h



ORD. NO.	LOAD CAPACITY kg	OVERALL DIM. mm
F ML 0460 00 01	1500	1200x800x800 h

■ KEY



■ For further information on containers and pallets see catalogue no. 600 section L.

GREY
F.....01



SERIES STORAGE BIG STEEL

TILTING CONTAINERS



ORD. NO.	LOAD CAPACITY kg
F ML 0200 00 01	1000
DIM. mm 965x1480x1060 h	



ORD. NO.	LOAD CAPACITY kg
F ML 0200 10 01	900
DIM. mm 965x1480x1265 h	
Including: 2 fixed nylon wheels Ø 160 mm, and 2 swivel nylon wheels Ø 160 mm without brake	



Containers may only be emptied with a fork lift truck.



Pull the steel cable to activate the tilting mechanism of the container while remaining comfortably seated on the fork lift truck.

CONTAINERS WITH ROLLER OPENING BASE



ORD. NO.	LOAD CAPACITY kg
F ML 0121 00 01	2000
DIM. mm 1000x800x1150 h	



ORD. NO.	LOAD CAPACITY kg
F ML 0111 00 01	2000
DIM. mm 1000x800x800 h	



Example of using roller base containers



1. base completely opened



2. base being closed with the aid of steel roller



2. base completely closed

RAL 7000
F... ..01

INFO ■



LENGTH = 1000 / 1165 mm

SERIES STORAGE BIG PLAST

PLASTIC CONTAINERS

■ ATTENTION: NOT SUITABLE FOR CHEMICAL LIQUIDS



■ 01



ORD. NO.

F PT 7040 00 01

Lids for ORD. NO. F PT 1040 00 01 / F PT 1140 00 01 / F PT 1240 00 01

■ 01



ORD. NO.

F PT 7540 00 01

Lids for ORD. NO. F PT 5040 00 01 / F PT 3040 00 01 / F PT 3140 00 01 / F PT 3240 00 01



Capacity litres 280

■ 01

ORD. NO.

LOAD CAPACITY kg

F PT 1040 00 01

150

DIM. mm 1000x640x655 h



Capacity litres 520

■ 01

ORD. NO.

LOAD CAPACITY kg

F PT 3040 00 01

250

DIM. mm 1165x790x800 h



Capacity litres 520

■ 01

ORD. NO.

LOAD CAPACITY kg

F PT 5040 00 01

300

DIM. mm 1165x790x800 h



Capacity litres 280

■ 01

ORD. NO.

DIM. mm

Ø WHEELS mm

LOAD CAPACITY kg

F PT 1140 00 01

1000x640x790 h

100

150

F PT 1240 00 01

1000x640x815 h

125

150

Supplied with 4 swivel wheels without brake



Capacity litres 520

■ 01

ORD. NO.

DIM. mm

Ø WHEELS mm

LOAD CAPACITY kg

F PT 3140 00 01

1165x790x935 h

100

200

F PT 3240 00 01

1165x790x960 h

125

250

Supplied with 4 swivel wheels without brake

HANDLE FOR TRANSPORT



■ 01

ORD. NO. **F PT 8010 00 01**

For ORD. NO. F PT 1140 00 01 / F PT 1240 00 01

ORD. NO. **F PT 8020 00 01**

For ORD. NO. F PT 3140 00 01 / F PT 3240 00 01



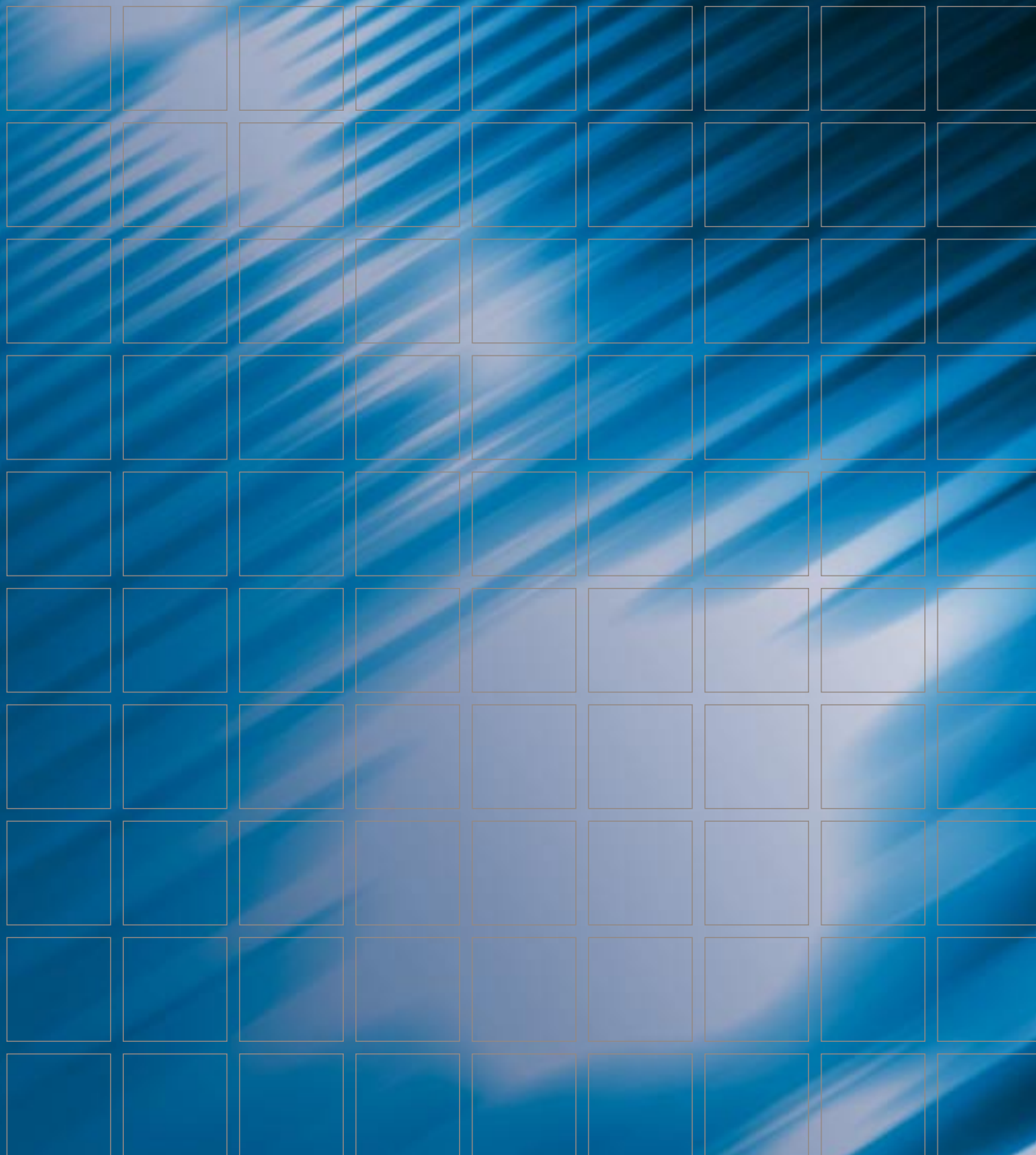

FAMI S.p.A.

Via Stazione Rossano, 13 | 36027 Rosà (VI) ITALY

T +39 0424 585455 r.a. | F +39 0424 585475

www.famispaspa.com | commerciale@famispaspa.com

Export department

T +39 0424 585455 | F +39 0424 585472

www.famispaspa.com | export@famispaspa.com

