

# G SPACE

# RETHINKING

- SHELVING SYSTEM F ST SERIES SYSTEM
- SHELVING SYSTEM F SV SERIES SYSTEM
- SHELVING SYSTEM F AR SERIES SYSTEM
- SHELVING SYSTEM F SR SERIES SYSTEM

HEAVY DUTY EXTENSION SHELVES LOAD CAPACITY 1000 kg

NORMAL EXTENSION DRAWERS 87% AND FULL EXTENSION DRAWERS 100%

VERSATILE

SEVERAL SERIES AVAILABLE



G SPACE      RETHINKING

SHELVING SYSTEMS SYSTEM ST

SAFETY INFORMATION

WALL FIXING



When fixing shelving to the wall, one wall anchor with a force of **1.3 Kn** (including the safety coefficient) must be used for each upright frame.

FLOOR FIXING



When fixing shelving to the floor, one floor bolt with a force of **4.3 Kn** (including the safety coefficient) must be used for each foot plate.

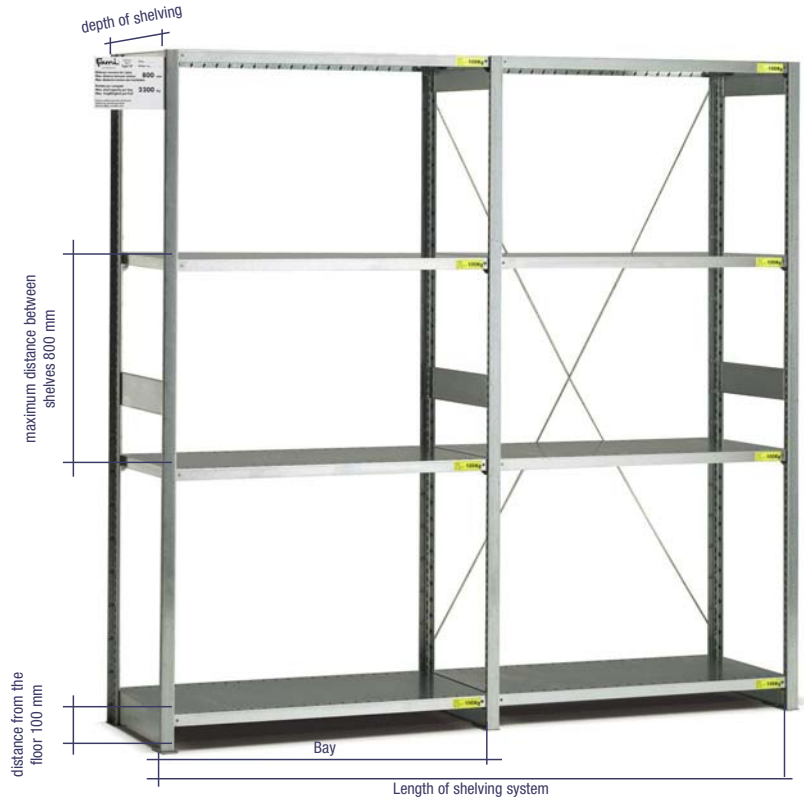

LOAD TABLE AND LABEL

A load table is supplied **standard** with each shelving system and a load label is provided with each shelf or drawer.

- The load table must be attached to a perfectly visible part of the shelving. It shows both the load capacity for each bay and the maximum permitted distance between shelves.
- The load label must be applied to the front of each shelf or drawer.



Example of a **standard** load label for shelves

P.S.: the sum of the load capacities of the shelves in each single bay must never exceed the overall load capacity of the bay indicated in the table.

	Scaffalatura serie Shelving type Regal Serie	ST	Anno di costruzione Year of Manufacture Herstellungsjahr	2002
	Ordine n. / Order no. / Auftrag Nr.		12445	
Distanza massima tra i piani Max. distance between shelves Max. Abstand zwischen den Fachböden			800 mm	
Portata per campata Max load capacity per bay Max. Tragfähigkeit pro Feld			2300 Kg	
Carico uniformemente distribuito / Uniformly distributed load / Gleichmäßig verteilte Last				

Example of a **standard** load table

LOAD LABEL IN SCREEN-PRINTED ALUMINIUM

When ordering a F ST shelving system, a load table in screen-printed aluminium complete with tabs for attaching it to the shelving may also be ordered.



Screen-printed load table for front  
**ORD. NO. F ST 9998 00 00**

Screen-printed load table for sides  
**ORD. NO. F ST 9999 00 00**

Position of the front table

Position of the side table



INSTRUCTIONS HANDBOOK

A complete and detailed instructions handbook is supplied standard with the shelving system.

This contains the following information:

- technical data
- intended use
- safety information and residue risk areas
- technical table for calculating the required floor strength
- installation and assembly instructions
- fixing instructions.



LENGTH = 2100/3100 mm DEPTH = 500 mm

## SHELVING SYSTEM SYSTEM ST



■ 54 ■ 55 ■ 99



■ Trolleys see page E0

## ORD. NO.

## SHELVES

**F ST S200 55 99**

12

Including 12 shelves dim. mm 1000x500x35 h

Load capacity of each shelf: 300 kg

Dimensions mm 3100x500x2000 h

■ 54 ■ 55 ■ 99



## ORD. NO.

## SHELVES

**F ST S200 57 99**

8

Including 8 shelves dim. mm 1000x500x35 h

Load capacity of each shelf: 300 kg

Dimensions mm 2100x500x2000 h

■ 54 ■ 55 ■ 99



## ORD. NO.

## SHELVES

**F ST S200 58 99**

10

Including 10 shelves dim. mm 1000x500x35 h

Load capacity of each shelf: 300 kg

Dimensions mm 2100x500x2000 h

## ■ KEY



- Load capacity of each bay: **2300 kg**
- Must be fixed to the floor or wall
- All indicated loads are net and refer to evenly distributed weights

■ Fixing set see page E4

RAL 5012  
GALVANISEDF.....54

RAL 7035  
GALVANISEDF.....55

GALVANISEDF.....99



SHELVING SYSTEMS SYSTEM ST20

HEIGHT 2000 mm

- 54
- 55
- 99



1000 mm LONG BAYS

Depth of bay mm	Single bay with cross bracing ORD. NO. galvanised	Add-on bay ORD. NO. galvanised	Add-on bay with cross bracing ORD. NO. galvanised	Single bay with back panel ORD. NO. galvanised	Add-on bay with back panel ORD. NO. galvanised
300	F ST A200 30 99	F ST B200 30 99	—	F ST D200 30 99	F ST E200 30 99
400	F ST A200 40 99	F ST B200 40 99	F ST C200 40 99	F ST D200 40 99	F ST E200 40 99
500	F ST A200 50 99	F ST B200 50 99	F ST C200 50 99	F ST D200 50 99	F ST E200 50 99
600	F ST A200 60 99	F ST B200 60 99	F ST C200 60 99	F ST D200 60 99	F ST E200 60 99
800	F ST A200 80 99	F ST B200 80 99	F ST C200 80 99	F ST D200 80 99	F ST E200 80 99

Each bay has 4 shelves. For 300 mm deep bays, the shelves are supplied without strengthening bars and have a load capacity of 120 kg. For 400 / 500 / 600 / 800 mm deep bays, the shelves are supplied with strengthening bars and have a load capacity of 300 kg.

1300 mm LONG BAYS

Depth of bay mm	Single bay with cross bracing ORD. NO. galvanised	Add-on bay ORD. NO. galvanised	Add-on bay with cross bracing ORD. NO. galvanised	Single bay with back panel ORD. NO. galvanised	Add-on bay with back panel ORD. NO. galvanised
300	F ST F200 30 99	F ST G200 30 99	—	F ST L200 30 99	F ST M200 30 99
400	F ST F200 40 99	F ST G200 40 99	F ST H200 40 99	F ST L200 40 99	F ST M200 40 99
500	F ST F200 50 99	F ST G200 50 99	F ST H200 50 99	F ST L200 50 99	F ST M200 50 99
600	F ST F200 60 99	F ST G200 60 99	F ST H200 60 99	F ST L200 60 99	F ST M200 60 99
800	F ST F200 80 99	F ST G200 80 99	F ST H200 80 99	F ST L200 80 99	F ST M200 80 99

Each bay has 4 shelves. For 300 mm deep bays, the shelves are supplied without strengthening bars and have a load capacity of 100 kg. For 600 mm deep bays, the shelves are supplied with strengthening bars and have a load capacity of 200 kg. For 400 / 500 / 800 mm deep bays, the shelves are supplied with strengthening bars and have a load capacity of 230 kg.

■ A cross bracing or a back panel must be fitted to each third bay (this does not apply to bays fixed to the wall)

**FLOOR SET FIXING**

Fixing material including no. 2 steel floor bolts M8x75 mm for uninterrupted concrete floors equal to or higher than class: B25 / RBK250 / MPa 25N for mm².  
ORD. NO. F NC 8999 00 99

**WALL SET FIXING**

■ All the bays which must be fixed to the wall are supplied standard with wall brackets.

**FOOT PLATES FIXING**

■ The single bays are supplied with an Allen key for fixing the foot plates.

RAL 5012 GALVANISEDF.....54 RAL 7035 GALVANISEDF.....55 GALVANISEDF.....99

■ The bays are supplied unassembled complete with foot plates

■ Load capacity of each bay: **2300 kg**

■ Must be fixed to the floor or wall

KEY ■

■ Must be fixed to the wall or floor

■ Must be fixed to the wall

■ All indicated loads are net and refer to evenly distributed weights

LENGTH = 1000/1300 mm HEIGHT = 2200 mm

## SHELVING SYSTEM SYSTEM ST22

HEIGHT 2200 mm

■ 54  
■ 55  
■ 99



## 1000 mm LONG BAYS

Depth of bay mm	Single bay with cross bracing ORD. NO. galvanised	Add-on bay ORD. NO. galvanised	Add-on bay with cross bracing ORD. NO. galvanised	Single bay with back panel ORD. NO. galvanised	Add-on bay with back panel ORD. NO. galvanised
300	F ST A220 30 99	F ST B220 30 99	—	F ST D220 30 99	F ST E220 30 99
400	F ST A220 40 99	F ST B220 40 99	F ST C220 40 99	F ST D220 40 99	F ST E220 40 99
500	F ST A220 50 99	F ST B220 50 99	F ST C220 50 99	F ST D220 50 99	F ST E220 50 99
600	F ST A220 60 99	F ST B220 60 99	F ST C220 60 99	F ST D220 60 99	F ST E220 60 99
800	F ST A220 80 99	F ST B220 80 99	F ST C220 80 99	F ST D220 80 99	F ST E220 80 99

Each bay has 4 shelves. For 300 mm deep bays, the shelves are supplied without strengthening bars and have a load capacity of 120 kg. For 400 / 500 / 600 / 800 mm deep bays, the shelves are supplied with strengthening bars and have a load capacity of 300 kg.

## 1300 mm LONG BAYS

Depth of bay mm	Single bay with cross bracing ORD. NO. galvanised	Add-on bay ORD. NO. galvanised	Add-on bay with cross bracing ORD. NO. galvanised	Single bay with back panel ORD. NO. galvanised	Add-on bay with back panel ORD. NO. galvanised
300	F ST F220 30 99	F ST G220 30 99	—	F ST L220 30 99	F ST M220 30 99
400	F ST F220 40 99	F ST G220 40 99	F ST H220 40 99	F ST L220 40 99	F ST M220 40 99
500	F ST F220 50 99	F ST G220 50 99	F ST H220 50 99	F ST L220 50 99	F ST M220 50 99
600	F ST F220 60 99	F ST G220 60 99	F ST H220 60 99	F ST L220 60 99	F ST M220 60 99
800	F ST F220 80 99	F ST G220 80 99	F ST H220 80 99	F ST L220 80 99	F ST M220 80 99

Each bay has 4 shelves. For 300 mm deep bays, the shelves are supplied without strengthening bars and have a load capacity of 100 kg. For 600 mm deep bays, the shelves are supplied with strengthening bars and have a load capacity of 200 kg. For 400 / 500 / 800 mm deep bays, the shelves are supplied with strengthening bars and have a load capacity of 230 kg.

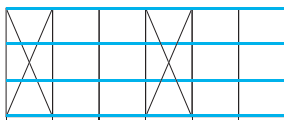

■ A cross bracing or a back panel must be fitted to each third bay (this does not apply to bays fixed to the wall)

## FLOOR SET FIXING



Fixing material including no. 2 steel floor bolts M8x75 mm for uninterrupted concrete floors equal to or higher than class: B25 / RBK250 / MP. 25N for mm<sup>2</sup>.

ORD. NO. F NC 8999 00 99

## WALL SET FIXING

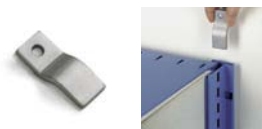

■ All the bays which must be fixed to the wall are supplied standard with wall brackets.

## FOOT PLATES FIXING



■ The single bays are supplied with an Allen key for fixing the foot plates.

## ■ KEY



Must be fixed to the wall or floor

Must be fixed to the wall

■ All indicated loads are net and refer to evenly distributed weights

■ The bays are supplied unassembled complete with foot plates

RAL 5012 GALVANISEDF.....54

■ Load capacity of each bay: **2300 kg**

RAL 7035 GALVANISEDF.....55

■ Must be fixed to the floor or wall

GALVANISEDF.....99

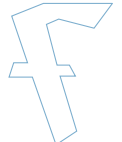

SHELVING SYSTEMS SYSTEM ST25

HEIGHT 2500 mm

- 54
- 55
- 99



1000 mm LONG BAYS

Depth of bay mm	Single bay with cross bracing ORD. NO. galvanised	Add-on bay ORD. NO. galvanised	Add-on bay with cross bracing ORD. NO. galvanised	Single bay with back panel ORD. NO. galvanised	Add-on bay with back panel ORD. NO. galvanised
300	F ST A250 30 99	F ST B250 30 99	–	F ST D250 30 99	F ST E250 30 99
400	F ST A250 40 99	F ST B250 40 99	–	F ST D250 40 99	F ST E250 40 99
500	F ST A250 50 99	F ST B250 50 99	F ST C250 50 99	F ST D250 50 99	F ST E250 50 99
600	F ST A250 60 99	F ST B250 60 99	F ST C250 60 99	F ST D250 60 99	F ST E250 60 99
800	F ST A250 80 99	F ST B250 80 99	F ST C250 80 99	F ST D250 80 99	F ST E250 80 99

Each bay has 5 shelves. For 300 mm deep bays, the shelves are supplied without strengthening bars and have a load capacity of 120 kg. For 400 / 500 / 600 / 800 mm deep bays, the shelves are supplied with strengthening bars and have a load capacity of 300 kg.

1300 mm LONG BAYS

Depth of bay mm	Single bay with cross bracing ORD. NO. galvanised	Add-on bay ORD. NO. galvanised	Add-on bay with cross bracing ORD. NO. galvanised	Single bay with back panel ORD. NO. galvanised	Add-on bay with back panel ORD. NO. galvanised
300	F ST F250 30 99	F ST G250 30 99	–	F ST L250 30 99	F ST M250 30 99
400	F ST F250 40 99	F ST G250 40 99	–	F ST L250 40 99	F ST M250 40 99
500	F ST F250 50 99	F ST G250 50 99	F ST H250 50 99	F ST L250 50 99	F ST M250 50 99
600	F ST F250 60 99	F ST G250 60 99	F ST H250 60 99	F ST L250 60 99	F ST M250 60 99
800	F ST F250 80 99	F ST G250 80 99	F ST H250 80 99	F ST L250 80 99	F ST M250 80 99

Each bay has 5 shelves. For 300 mm deep bays, the shelves are supplied without strengthening bars and have a load capacity of 100 kg. For 600 mm deep bays, the shelves are supplied with strengthening bars and have a load capacity of 200 kg. For 400 / 500 / 800 mm deep bays, the shelves are supplied with strengthening bars and have a load capacity of 230 kg.

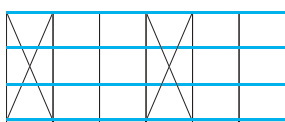

■ A cross bracing or a back panel must be fitted to each third bay (this does not apply to bays fixed to the wall)

FLOOR SET FIXING



Fixing material including no. 2 steel floor bolts M8x75 mm for uninterrupted concrete floors equal to or higher than class: B25 / RBK250 / MPa 25N for mm².  
ORD. NO. F NC 8999 00 99

WALL SET FIXING



■ All the bays which must be fixed to the wall are supplied standard with wall brackets.

FOOT PLATES FIXING



■ The single bays are supplied with an Allen key for fixing the foot plates.

- RAL 5012 GALVANISEDF.....54
- RAL 7035 GALVANISEDF.....55
- GALVANISEDF.....99

KEY ■

- Must be fixed to the wall or floor
- Must be fixed to the wall
- All indicated loads are net and refer to evenly distributed weights



■ The bays are supplied unassembled complete with foot plates

■ Load capacity of each bay: 2300 kg

■ Must be fixed to the floor or wall



LENGTH = 1000/1300 mm HEIGHT = 3000 mm

## SHELVING SYSTEM SYSTEM ST30

HEIGHT 3000 mm

■ 54  
■ 55  
■ 99



## 1000 mm LONG BAYS

Depth of bay mm	Single bay with cross bracing ORD. NO. galvanised	Add-on bay ORD. NO. galvanised	Add-on bay with cross bracing ORD. NO. galvanised	Single bay with back panel ORD. NO. galvanised	Add-on bay with back panel ORD. NO. galvanised
300	F ST A300 30 99	F ST B300 30 99	—	F ST D300 30 99	F ST E300 30 99
400	F ST A300 40 99	F ST B300 40 99	—	F ST D300 40 99	F ST E300 40 99
500	F ST A300 50 99	F ST B300 50 99	F ST C300 50 99	F ST D300 50 99	F ST E300 50 99
600	F ST A300 60 99	F ST B300 60 99	F ST C300 60 99	F ST D300 60 99	F ST E300 60 99
800	F ST A300 80 99	F ST B300 80 99	F ST C300 80 99	F ST D300 80 99	F ST E300 80 99

Each bay has 6 shelves. For 300 mm deep bays, the shelves are supplied without strengthening bars and have a load capacity of 120 kg. For 400 / 500 / 600 / 800 mm deep bays, the shelves are supplied with strengthening bars and have a load capacity of 300 kg.

## 1300 mm LONG BAYS

Depth of bay mm	Single bay with cross bracing ORD. NO. galvanised	Add-on bay ORD. NO. galvanised	Add-on bay with cross bracing ORD. NO. galvanised	Single bay with back panel ORD. NO. galvanised	Add-on bay with back panel ORD. NO. galvanised
300	F ST F300 30 99	F ST G300 30 99	—	F ST L300 30 99	F ST M300 30 99
400	F ST F300 40 99	F ST G300 40 99	—	F ST L300 40 99	F ST M300 40 99
500	F ST F300 50 99	F ST G300 50 99	F ST H300 50 99	F ST L300 50 99	F ST M300 50 99
600	F ST F300 60 99	F ST G300 60 99	F ST H300 60 99	F ST L300 60 99	F ST M300 60 99
800	F ST F300 80 99	F ST G300 80 99	F ST H300 80 99	F ST L300 80 99	F ST M300 80 99

Each bay has 6 shelves. For 300 mm deep bays, the shelves are supplied without strengthening bars and have a load capacity of 100 kg. For 600 mm deep bays, the shelves are supplied with strengthening bars and have a load capacity of 200 kg. For 400 / 500 / 800 mm deep bays, the shelves are supplied with strengthening bars and have a load capacity of 230 kg.

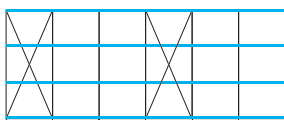

■ A cross bracing or a back panel must be fitted to each third bay (this does not apply to bays fixed to the wall)

## FLOOR SET FIXING



Fixing material including no. 2 steel floor bolts M8x75 mm for uninterrupted concrete floors equal to or higher than class: B25 / RBK250 / MP. 25N for mm<sup>2</sup>.

ORD. NO. F NC 8999 00 99

## WALL SET FIXING

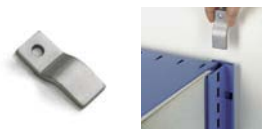

■ All the bays which must be fixed to the wall are supplied standard with wall brackets.

## FOOT PLATES FIXING



■ The single bays are supplied with an Allen key for fixing the foot plates.

## ■ KEY



Must be fixed to the wall or floor

Must be fixed to the wall

■ All indicated loads are net and refer to evenly distributed weights

■ The bays are supplied unassembled complete with foot plates

RAL 5012  
GALVANISEDF.....54

■ Load capacity of each bay:  
**2300 kg**

RAL 7035  
GALVANISEDF.....55

■ Must be fixed to the floor or wall





SHELVING SYSTEMS SYSTEM ST

UPRIGHT FRAMES 1000 mm h

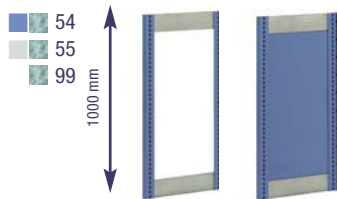

Depth of bay mm	Upright frame with 2 connection bars ORD. NO.	Upright frame with 2 connection bars + intermediate panel 1000 mm h ORD. NO.
300	F ST 0100 30 54	F ST 0101 30 54
400	F ST 0100 40 54	F ST 0101 40 54
500	F ST 0100 50 54	F ST 0101 50 54
600	F ST 0100 60 54	F ST 0101 60 54
800	F ST 0100 80 54	F ST 0101 80 54

UPRIGHT FRAMES 2000 mm h

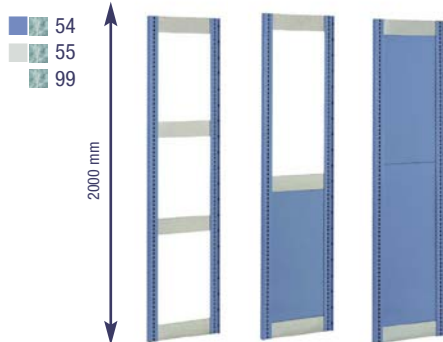

Depth of bay mm	Upright frame with 4 connection bars ORD. NO.	Upright frame with 3 connection bars + intermediate panel 1000 mm h ORD. NO.	Upright frame with 2 connection bars + intermediate panel 2000 mm h ORD. NO.
300	F ST 0200 30 54	F ST 0201 30 54	F ST 0202 30 54
400	F ST 0200 40 54	F ST 0201 40 54	F ST 0202 40 54
500	F ST 0200 50 54	F ST 0201 50 54	F ST 0202 50 54
600	F ST 0200 60 54	F ST 0201 60 54	F ST 0202 60 54
800	F ST 0200 80 54	F ST 0201 80 54	F ST 0202 80 54

UPRIGHT FRAMES 2200 mm h



Depth of bay mm	Upright frame with 4 connection bars ORD. NO.	Upright frame with 3 connection bars + intermediate panel 1000 mm h ORD. NO.	Upright frame with 3 connection bars + intermediate panel 2000 mm h ORD. NO.	Upright frame with 2 connection bars + intermediate panel 2200 mm ORD. NO.
300	F ST 0220 30 54	F ST 0221 30 54	F ST 0222 30 54	F ST 0223 30 54
400	F ST 0220 40 54	F ST 0221 40 54	F ST 0222 40 54	F ST 0223 40 54
500	F ST 0220 50 54	F ST 0221 50 54	F ST 0222 50 54	F ST 0223 50 54
600	F ST 0220 60 54	F ST 0221 60 54	F ST 0222 60 54	F ST 0223 60 54
800	F ST 0220 80 54	F ST 0221 80 54	F ST 0222 80 54	F ST 0223 80 54

FLOOR SET FIXING



Fixing material including no. 2 steel floor bolts M8x75 mm for uninterrupted concrete floors equal to or higher than class: B25 / RBK250 / MPa 25N for mm².  
ORD. NO. F NC 8999 00 99

CONNECTION SET FOR BACK TO BACK UPRIGHT FRAMES



The clips are made of galvanised steel and are inserted into the rear of the upright frames. Each connection set includes 4 galvanised clips. ORD. NO. F ST 0720 00 99

WALL SET FIXING



All the bays which must be fixed to the wall are supplied with wall brackets.

FOOT PLATES FIXING



The single bays are supplied with an Allen key for fixing the foot plates.

RAL 5012 GALVANISEDF...54 RAL 7035 GALVANISEDF...55 GALVANISEDF...99

KEY

- Must be fixed to the wall or floor
- Must be fixed to the wall

The bays are supplied unassembled complete with foot plates



HEIGHT = 2500 / 3000 mm

SHELVING SYSTEM SYSTEM ST

UPRIGHT FRAMES 2500 mm h



Side, intermediate, back panels and doors can be used to turn all or part of the shelving unit into a cabinet.

Depth of bay mm		Upright frame with 4 connection bars ORD. NO.	Upright frame with 4 connection bars + intermediate panel 1000 mm h ORD. NO.	Upright frame with 3 connection bars + intermediate panel 2000 mm h ORD. NO.	Upright frame with 3 connection bars + intermediate panel 2200 mm h ORD. NO.	Upright frame with 3 connection bars + intermediate panel 2500 mm h ORD. NO.
300	F ST 0250 30 54	F ST 0251 30 54	F ST 0252 30 54	F ST 0253 30 54	F ST 0254 30 54	
400	F ST 0250 40 54	F ST 0251 40 54	F ST 0252 40 54	F ST 0253 40 54	F ST 0254 40 54	
500	F ST 0250 50 54	F ST 0251 50 54	F ST 0252 50 54	F ST 0253 50 54	F ST 0254 50 54	
600	F ST 0250 60 54	F ST 0251 60 54	F ST 0252 60 54	F ST 0253 60 54	F ST 0254 60 54	
800	F ST 0250 80 54	F ST 0251 80 54	F ST 0252 80 54	F ST 0253 80 54	F ST 0254 80 54	

UPRIGHT FRAMES 3000 mm h



Depth of bay mm		Upright frame with 6 connection bars ORD. NO.	Upright frame with 4 connection bars + intermediate panel 1000 mm h ORD. NO.	Upright frame with 3 connection bars + intermediate panel 2000 mm h ORD. NO.	Upright frame with 3 connection bars + intermediate panel 2200 mm h ORD. NO.	Upright frame with 3 connection bars + intermediate panel 2500 mm h ORD. NO.	Upright frame with 2 connection bars + intermediate panel 3000 mm h ORD. NO.
300	F ST 0300 30 54	F ST 0301 30 54	F ST 0302 30 54	F ST 0303 30 54	F ST 0304 30 54	F ST 0305 30 54	
400	F ST 0300 40 54	F ST 0301 40 54	F ST 0302 40 54	F ST 0303 40 54	F ST 0304 40 54	F ST 0305 40 54	
500	F ST 0300 50 54	F ST 0301 50 54	F ST 0302 50 54	F ST 0303 50 54	F ST 0304 50 54	F ST 0305 50 54	
600	F ST 0300 60 54	F ST 0301 60 54	F ST 0302 60 54	F ST 0303 60 54	F ST 0304 60 54	F ST 0305 60 54	
800	F ST 0300 80 54	F ST 0301 80 54	F ST 0302 80 54	F ST 0303 80 54	F ST 0304 80 54	F ST 0305 80 54	

KEY



Must be fixed to the wall or floor



Must be fixed to the wall

The bays are supplied unassembled complete with foot plates

RAL 5012 GALVANISEDF.....54

RAL 7035 GALVANISEDF.....55

GALVANISEDF.....99

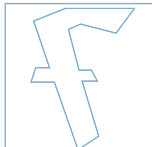

## SHELVING SYSTEMS SYSTEM ST

## SLOTTED SHELVES LENGTH 1000 mm

ORD. NO.	DIMENSIONS mm	NO. OF BARS	LOAD CAPACITY kg
F ST 1030 00 04	1000x300x35 h	–	120
F ST 1040 00 04	1000x400x35 h	–	120
F ST 1040 01 04	1000x400x35 h	1	300
F ST 1050 00 04	1000x500x35 h	–	120
F ST 1050 01 04	1000x500x35 h	1	300
F ST 1050 02 04	1000x500x35 h	2	400
F ST 1060 00 04	1000x600x35 h	–	120
F ST 1060 01 04	1000x600x35 h	1	300
F ST 1060 02 04	1000x600x35 h	2	400
F ST 1080 00 04	1000x800x35 h	–	120
F ST 1080 01 04	1000x800x35 h	1	300
F ST 1080 02 04	1000x800x35 h	2	400



The shelves are slotted at 40.5 mm increments in order to hold shelf dividers or shelf panels. The special folds on the long sides considerably reinforce the shelf structure. Strengthening bars can be added, without the aid of screws, to increase the load capacity of the shelves.

Available galvanised, blue Ral 5012 or gray Ral 7035.



■ The shelves in this series are supplied with load labels.

## SLOTTED SHELVES LENGTH 1300 mm

ORD. NO.	DIMENSIONS mm	NO. OF BARS	LOAD CAPACITY kg
F ST 1130 00 04	1300x300x35 h	–	100
F ST 1140 00 04	1300x400x35 h	–	100
F ST 1140 01 04	1300x400x35 h	1	230
F ST 1150 00 04	1300x500x35 h	–	100
F ST 1150 01 04	1300x500x35 h	1	230
F ST 1150 02 04	1300x500x35 h	2	300
F ST 1160 00 04	1300x600x35 h	–	100
F ST 1160 01 04	1300x600x35 h	1	200
F ST 1160 02 04	1300x600x35 h	2	300
F ST 1180 00 04	1300x800x35 h	–	100
F ST 1180 01 04	1300x800x35 h	1	230
F ST 1180 02 04	1300x800x35 h	2	300

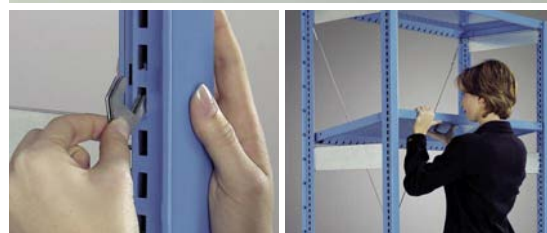

Assembling the strengthening bar and the shelf

## STRENGTHENING BAR LENGTH 1000 mm

■ 99



ORD. NO. R FST 0005 99

## SET OF 4 SPARE GALVANISED CLIPS



■ 99

ORD. NO. R FST 0003 99

## STRENGTHENING BAR LENGTH 1300 mm

■ 99



ORD. NO. R FST 0006 99

## SPARE STRENGTHENING BAR FOR SHELVES 800 mm DEEP

■ 99



ORD. NO. R FST 0004 99

## MAGNETIC SUPPORT WITH LABEL



ORD. NO. F ST 9997 00 00

Magnetic support with label and cellophane length 1000 mm

ORD. NO. R FST 0007 00

Spare label and cellophane (100 pcs)



LENGTH = 1000 / 1300 mm

## SHELVING SYSTEM SYSTEM ST

## Assembling the base plinth

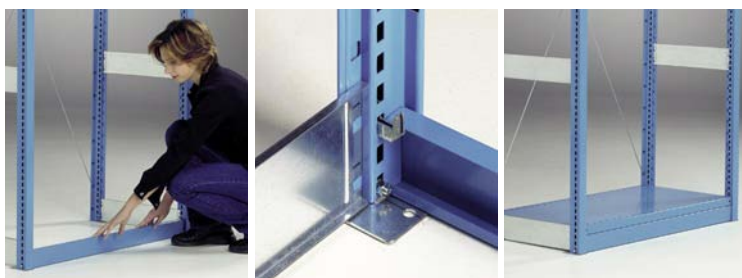

## BASE PLINTHS



■ 04  
■ 08  
■ 99

## ORD. NO.

LENGTH mm

F ST 7510 00 04

1000

F ST 7520 00 04

1300

The base plinths are used to close the lower part of the shelving. They are assembled without screws and are available in two lengths: 1000 mm and 1300 mm. Available galvanised, blue Ral 5012 or grey Ral 7035.

## SLIDING DOORS



■ 04  
■ 08

The sliding doors increase the shelving depth of 80 mm and one pair of doors closes 2 shelving bays. Available for 1000 mm and 1300 mm long bays, they are easy to be assembled (just 6 screws are used for a pair of doors). The doors are supplied with a safety lock and 2 keys.

Available in blue Ral 5012 or gray Ral 7035.



■ This type of door closes 2 bays



## ORD. NO.

DIMENSIONS LxH mm

F ST 5720 00 04

2000x2000 h

F ST 5820 00 04

2600x2000 h

## FOOT PLATES FIXING



■ Allen key supplied standard

## LEAF DOORS



■ 04  
■ 08

The leaf doors increase the shelving depth of 22 mm and one pair of doors closes one shelving bay. Available for 1000 mm and 1300 mm long bays, they are easy to be assembled (just 4 screws are used for a pair of doors). The doors are supplied with a safety lock and 2 keys.

Available in blue Ral 5012 or gray Ral 7035.



■ This type of door closes 1 bay



## ORD. NO.

DIMENSIONS LxH mm

F ST 5110 00 04

1000x1000 h

F ST 5120 00 04

1000x2000 h

F ST 5210 00 04

1300x1000 h

F ST 5220 00 04

1300x2000 h

## FOOT PLATES FIXING



■ Allen key supplied standard

SHELVING SYSTEMS SYSTEM ST

CROSS BRACINGS



ORD. NO. GALVANISED	DIM. LxH mm
F ST 7110 00 99	1000x1000 h
F ST 7120 00 99	1000x2000 h
F ST 7122 00 99	1000x2200 h
F ST 7125 00 99	1000x2500 h
F ST 7130 00 99	1000x3000 h

ORD. NO. GALVANISED	DIM. LxH mm
F ST 7210 00 99	1300x1000 h
F ST 7220 00 99	1300x2000 h
F ST 7222 00 99	1300x2200 h
F ST 7225 00 99	1300x2500 h
F ST 7230 00 99	1300x3000 h

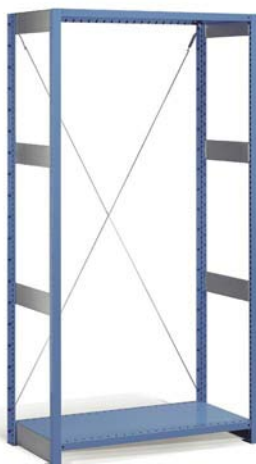

The cross bracing is attached to the shelving from the front side without using screws. This system makes assembly easy especially if the shelving is positioned against the wall.  
**Available galvanised.**

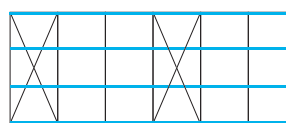

■ A cross bracing must be fitted to each third bay

Assembling the cross bracing



MESH BACK PANELS



Mesh size 40.5x100 mm h

ORD. NO. GALVANISED	DIM. LxH mm
F ST 2820 10 99	1000x2000 h
F ST 2822 10 99	1000x2200 h
F ST 2825 10 99	1000x2500 h
F ST 2830 10 99	1000x3000 h

ORD. NO. GALVANISED	DIM. LxH mm
F ST 2820 13 99	1300x2000 h
F ST 2822 13 99	1300x2200 h
F ST 2825 13 99	1300x2500 h
F ST 2830 13 99	1300x3000 h



SPARE CLIPS FOR MESH PANEL

ORD. NO. R FST 0002 99



The mesh back panel is attached to the shelving from the front side using galvanised hooks. This system makes assembly easy especially if the shelving is positioned against the wall. **Available galvanised.**

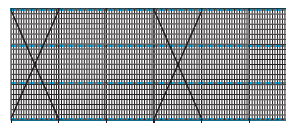

■ A cross bracing must be fitted to each third bay

Assembling the mesh panel



LENGTH = 1000 / 1300 mm

SHELVING SYSTEM SYSTEM ST

BACK PANELS



- 04
- 08
- 99

ORD. NO. GALVANISED	DIM. LxH mm
F ST 2020 10 04	1000x2000 h
F ST 2022 10 04	1000x2200 h
F ST 2025 10 04	1000x2500 h
F ST 2030 10 04	1000x3000 h

ORD. NO. GALVANISED	DIM. LxH mm
F ST 2020 13 04	1300x2000 h
F ST 2022 13 04	1300x2200 h
F ST 2025 13 04	1300x2500 h
F ST 2030 13 04	1300x3000 h

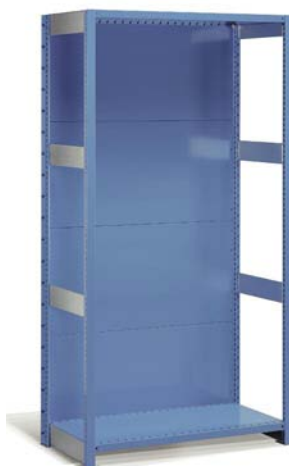

The back panels are also attached to the shelving from the front. No screws are used. This system makes assembly easy especially if the shelving is positioned against the wall. Supplied in various sections depending on the height of the shelving.

Available galvanised, blue Ral 5012 or grey Ral 7035.



■ A back panel must be fitted to each third bay



Assembling the back panel

STRENGTHENING BARS



■ 99

ORD. NO. GALVANISED	FOR BAYS LENGTH mm
F ST 9550 01 99*	1000
F ST 9560 01 99*	1300

\*Set of 4 strengthening bars and 8 supports

This set includes 4 strengthening bars and 8 supports and is used to strengthen the shelving without having to use cross bracings or back panels. Two bars must be fitted at the top and two at the bottom of each bay. Available galvanised.

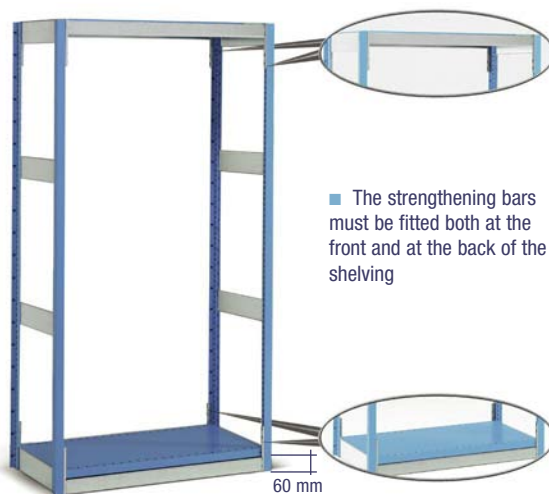

■ The strengthening bars must be fitted both at the front and at the back of the shelving

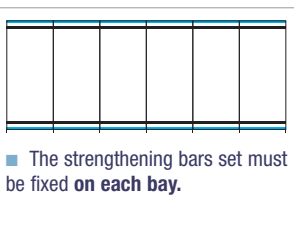

■ The strengthening bars set must be fixed on each bay.

Assembling the strengthening bars



# SHELVING SYSTEMS SYSTEM ST

## SHELF DIVIDERS

The shelf dividers are fitted into the shelf slots. They have a **standard height of 100 mm** and are supplied **galvanised**.

■ 99



ORD. NO. GALVANISED

DEPTH OF SHELVING mm

<b>F ST 9230 00 99</b>	<b>300</b>
<b>F ST 9240 00 99</b>	<b>400</b>
<b>F ST 9250 00 99</b>	<b>500</b>
<b>F ST 9260 00 99</b>	<b>600</b>
<b>F ST 9280 00 99</b>	<b>800</b>

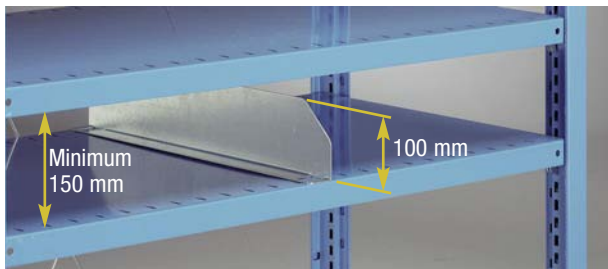

Assembling a shelf divider



## SHELF PANELS

The shelf panels are fitted into the slots between two shelves. They are available **galvanised** and in various heights ranging from 165 to 415 mm and in 5 different depths.

■ 99



Assembling a shelf panel



Distance between shelves

Space between shelves

Space between shelves mm	Distance between shelves mm	Depth of shelving unit 300 mm ORD. NO. galvanised	Depth of shelving unit 400 mm ORD. NO. galvanised	Depth of shelving unit 500 mm ORD. NO. galvanised	Depth of shelving unit 600 mm ORD. NO. galvanised	Depth of shelving unit 800 mm ORD. NO. galvanised
165	200	<b>F ST 9000 00 99</b>	<b>F ST 9030 00 99</b>	<b>F ST 9060 00 99</b>	<b>F ST 9090 00 99</b>	<b>F ST 9150 00 99</b>
215	250	<b>F ST 9005 00 99</b>	<b>F ST 9035 00 99</b>	<b>F ST 9065 00 99</b>	<b>F ST 9095 00 99</b>	<b>F ST 9155 00 99</b>
265	300	<b>F ST 9010 00 99</b>	<b>F ST 9040 00 99</b>	<b>F ST 9070 00 99</b>	<b>F ST 9100 00 99</b>	<b>F ST 9160 00 99</b>
315	350	<b>F ST 9015 00 99</b>	<b>F ST 9045 00 99</b>	<b>F ST 9075 00 99</b>	<b>F ST 9105 00 99</b>	<b>F ST 9165 00 99</b>
365	400	<b>F ST 9020 00 99</b>	<b>F ST 9050 00 99</b>	<b>F ST 9080 00 99</b>	<b>F ST 9110 00 99</b>	<b>F ST 9170 00 99</b>
415	450	<b>F ST 9025 00 99</b>	<b>F ST 9055 00 99</b>	<b>F ST 9085 00 99</b>	<b>F ST 9115 00 99</b>	<b>F ST 9175 00 99</b>

DEPTH = 300 / 400 / 500 / 600 / 800 mm

## SHELVING SYSTEM SYSTEM ST

## SET OF TROUGH PANELS AND TAPERED TROUGH DIVIDERS

Both trough panels are slotted in 50 mm increments to fit the tapered dividers. Assembly is quick and easy. **No screws are used.** The trough panels are available **galvanised, blue Ral 5012 or grey Ral 7035**, while the tapered dividers are available **galvanised only**.

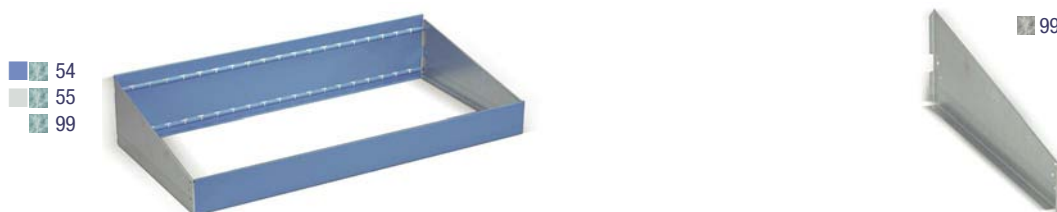

## SET OF TROUGH PANELS WITH TWO TAPERED TROUGH DIVIDERS FOR 1000 mm LONG SHELVES

ORD. NO.	DEPTH mm
F ST 9510 30 54	300
F ST 9510 40 54	400
F ST 9510 50 54	500
F ST 9510 60 54	600

## SET OF TROUGH PANELS WITH TWO TAPERED TROUGH DIVIDERS FOR 1300 mm LONG SHELVES

ORD. NO.	DEPTH mm
F ST 9520 30 54	300
F ST 9520 40 54	400
F ST 9520 50 54	500
F ST 9520 60 54	600

## ADDITIONAL TAPERED TROUGH DIVIDER

ORD. NO.	DEPTH mm
F ST 9630 00 99	300
F ST 9640 00 99	400
F ST 9650 00 99	500
F ST 9660 00 99	600



Assembling the trough panels and the tapered trough dividers

## FULL EXTENSION SUSPENSION FOLDER FRAME FOR SUSPENSION FOLDER DIN A4

The suspension folder frames are supplied with full extension guide rails (100% extraction) with 30 Kg load capacity. Overall dimensions 990x500 mm. **These frames can only be used for 1000 mm long and 500 mm deep bays.** Available in **black Ral 9011**.



ORD. NO. F ST 7850 00 07

## NORMAL EXTENSION AND FULL EXTENSION DRAWERS

The drawers are available either with normal extension (88% extraction) or full extension (100% extraction) guide rails with a front height of 100 mm. The slotted internal side walls and perforated bottom with 17 mm fixed increments make the metal partitions easy to be inserted and fixed (with screws). They are made from sheet steel and **can only be used for 1000 mm long and 500 mm deep bays.** Available **blue Ral 5012 or grey Ral 7035**.

## NORMAL EXTENSION DRAWERS

ORD. NO.	FRONT HEIGHT mm	LOAD CAPACITY kg	USABLE DIMENSIONS mm
F ST 8510 00 04	100	50	906x447x85 h

Extension (88%)

A maximum of 6 drawers can be fitted on each bay. The maximum permitted height for fitting drawers is 1000 mm.



Set of partitions see page A113

## FULL EXTENSION DRAWERS

ORD. NO.	FRONT HEIGHT mm	LOAD CAPACITY kg	USABLE DIMENSIONS mm
F ST 8610 00 04	100	100	906x447x85 h

Extension (100%)

A maximum of 3 drawers can be fitted on each bay (or 6 if the load capacity is reduced to 50 Kg). The maximum permitted height for fitting drawers is 1000 mm.





## SHELVING SYSTEMS SYSTEM ST

## PLAIN SIDE PANELS

ORD. NO.	FOR UPRIGHT FRAMES DIM. mm
F ST 2210 30 04	300x1000
F ST 2210 40 04	400x1000
F ST 2210 50 04	500x1000
F ST 2210 60 04	600x1000
F ST 2210 80 04	800x1000

ORD. NO.	FOR UPRIGHT FRAMES DIM. mm
F ST 2220 30 04	300x2000
F ST 2220 40 04	400x2000
F ST 2220 50 04	500x2000
F ST 2220 60 04	600x2000
F ST 2220 80 04	800x2000

ORD. NO.	FOR UPRIGHT FRAMES DIM. mm
F ST 2222 30 04	300x2200
F ST 2222 40 04	400x2200
F ST 2222 50 04	500x2200
F ST 2222 60 04	600x2200
F ST 2222 80 04	800x2200

ORD. NO.	FOR UPRIGHT FRAMES DIM. mm
F ST 2225 30 04	300x2500
F ST 2225 40 04	400x2500
F ST 2225 50 04	500x2500
F ST 2225 60 04	600x2500
F ST 2225 80 04	800x2500

ORD. NO.	FOR UPRIGHT FRAMES DIM. mm
F ST 2230 30 04	300x3000
F ST 2230 40 04	400x3000
F ST 2230 50 04	500x3000
F ST 2230 60 04	600x3000
F ST 2230 80 04	800x3000



- 04
- 08
- 99

The side panels are connected to the upright frame with proper clips and without screws.



## ORD. NO. R FST 0001 99

Set of 4 spare galvanised clips for side panels

## PERFORATED SIDE PANELS

ORD. NO.	FOR UPRIGHT FRAMES DIM. mm
F ST 2310 30 04	300x1000
F ST 2310 40 04	400x1000
F ST 2310 50 04	500x1000
F ST 2310 60 04	600x1000
F ST 2310 80 04	800x1000

ORD. NO.	FOR UPRIGHT FRAMES DIM. mm
F ST 2320 30 04	300x2000
F ST 2320 40 04	400x2000
F ST 2320 50 04	500x2000
F ST 2320 60 04	600x2000
F ST 2320 80 04	800x2000

ORD. NO.	FOR UPRIGHT FRAMES DIM. mm
F ST 2322 30 04	300x2200
F ST 2322 40 04	400x2200
F ST 2322 50 04	500x2200
F ST 2322 60 04	600x2200
F ST 2322 80 04	800x2200

ORD. NO.	FOR UPRIGHT FRAMES DIM. mm
F ST 2325 30 04	300x2500
F ST 2325 40 04	400x2500
F ST 2325 50 04	500x2500
F ST 2325 60 04	600x2500
F ST 2325 80 04	800x2500

ORD. NO.	FOR UPRIGHT FRAMES DIM. mm
F ST 2330 30 04	300x3000
F ST 2330 40 04	400x3000
F ST 2330 50 04	500x3000
F ST 2330 60 04	600x3000
F ST 2330 80 04	800x3000



- 04
- 08
- 99

The side panels are connected to the upright frame with proper clips and without screws.

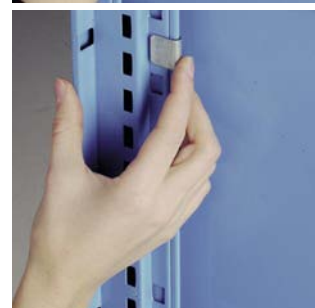
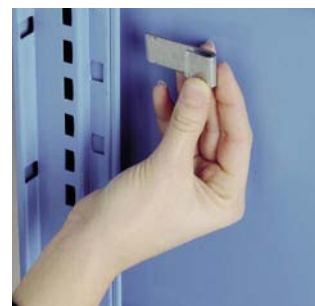

## ORD. NO. R FST 0001 99

Set of 4 spare galvanised clips for side panels



LENGTH = 800 / 1000 / 1250 mm

## SHELVING SYSTEM SYSTEM ST

## CONNECTING BAR BETWEEN SHELVING UNITS

■ 99

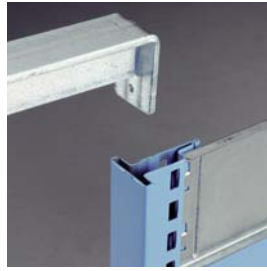

Fitting the connection bar into the upright

ORD. NO. GALVANISED LENGTH mm

F ST 0820 00 99 800

F ST 0830 00 99 1000

F ST 0840 00 99 1250

## AISLES:

If the layout of the shelving system includes aisles, metal or mesh panels must be fitted on all the sides that are not used for picking up or setting down the material. These aisles must have the following widths:

- Aisles used for manually picking up or setting down material from the shelving without drawers. Manually pushed trolleys may not be used: minimum width 800 mm.
- Aisles used for picking up or setting down material from the shelving through manually pushed trolleys (shelving system with or without drawers): minimum width 1250 mm.
- Aisles used for staff transit: minimum width 1250 mm.

Aisles used for picking up or setting down material cannot be used for staff transit. If aisles are required to be used for the transit of powered trolleys, please contact FAMI for further details.

**Caution:** for back to back shelving, back panels, mesh back panels or shelf stoppers must be mounted between the two shelving units in order to prevent the material stored on one side of the shelving from being accidentally pushed to the other side when material is being set down.

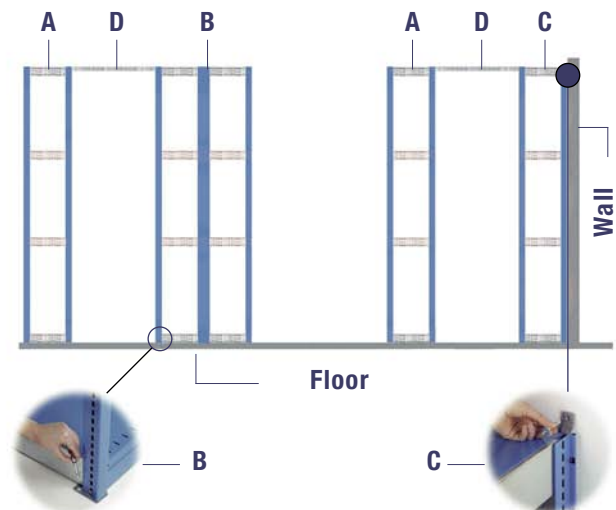
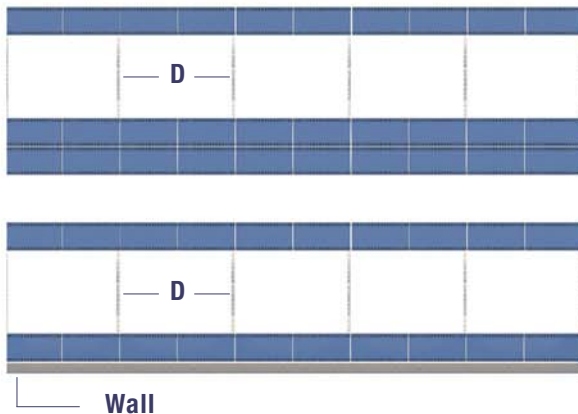

Caution: connection bars must be used for wall-fixed upright frames if these cannot be fixed to the wall. In this case the upright frame in question must be connected to a back to back upright frame which is either fixed to the floor or has one upright frame fixed to the wall.

To calculate the number of connection bars required to connect two shelving units, please see the above figure.

- The external upright frames must always be connected.
- The internal upright frames must be connected every two bays.

- A = Upright frame fixed with a connection bar.
- B = Back to back upright frames fixed to the floor.
- C = Single upright frame fixed to the wall.
- D = Upper safety connecting bar.

## ■ INFO

RAL 5012 F. ....04

RAL 7035 F. ....08

GALVANISEDF. ....99

[www.famispa.com](http://www.famispa.com)

# SHELVING SYSTEMS SYSTEM ST

## GUIDE RAILS FOR MULTIBOX



Assembling the guide rails for multibox



ORD. NO. GALVANISED	DEPTH OF SHELVING mm
F ST 9830 00 99	300
F ST 9840 00 99	400
F ST 9850 00 99	500
F ST 9860 00 99	600

■ Multibox  
see page G42

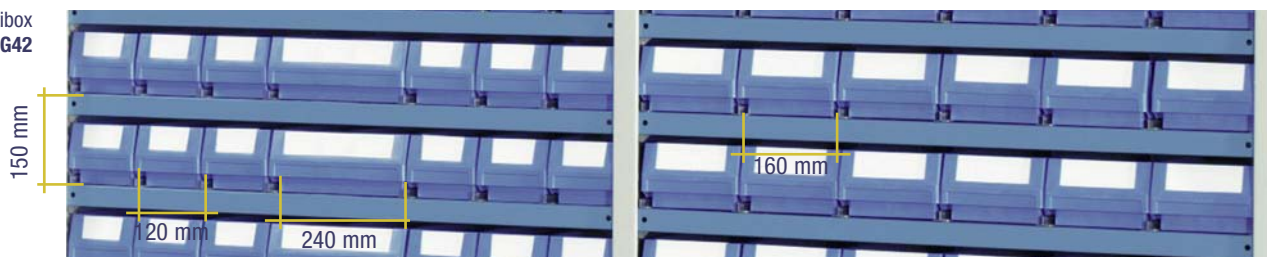

## SAFETY GUARDS FOR MULTIBOX BOXES

Made from galvanised sheet steel, the safety guards prevent the boxes from falling out by accident.

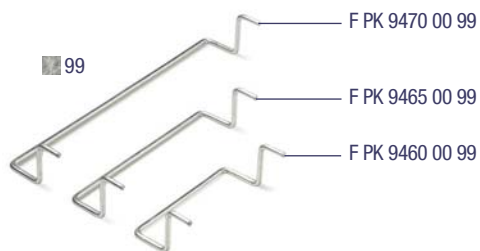

Assembling the safety guards



■ 99

**ORD. NO. F ST 9996 00 99**  
Set of 2 galvanised safety pins to tighten the shelves.

ORD. NO. GALVANISED	FOR BOXES	Ø mm
<b>F PK 9460 00 99</b>	F PK 0551 00 04	4.2
	F PK 1551 00 04	
	F PK 3051 00 04	
<b>F PK 9465 00 99</b>	F PK 1051 00 04	4.2
	F PK 2051 00 04	
	F PK 3551 00 04	
	F PK 4551 00 04	
<b>F PK 9470 00 99</b>	F PK 2551 00 04	4.2
	F PK 4051 00 04	



■ If Multibox containers are used with the shelving system, safety pins must be fitted on all the shelves in the system in order to prevent the upper shelf from coming loose if the Multibox is pushed down when open.

■ **Attention:** the strengthening bar can't be assembled on the shelves in which containers series multibox with safety guards are going to be inserted.

## MULTIBOX

Standard colour:

■ BLUE F. ....04

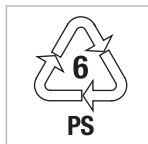

ORD. NO. GALVANISED	DIM. mm
<b>F PK 0551 00 04</b>	300x120x100 h
<b>F PK 1551 00 04</b>	400x120x100 h
<b>F PK 3051 00 04</b>	500x120x100 h

ORD. NO. GALVANISED	DIM. mm
<b>F PK 1051 00 04</b>	300x160x100 h
<b>F PK 2051 00 04</b>	400x160x100 h
<b>F PK 3551 00 04</b>	500x160x100 h
<b>F PK 4551 00 04</b>	600x160x100 h

ORD. NO. GALVANISED	DIM. mm
<b>F PK 2551 00 04</b>	400x240x100 h
<b>F PK 4051 00 04</b>	500x240x100 h

**ORD. NO. F PK 9540 00 00**  
Quantity per sheet 12



**ORD. NO. F PK 9580 00 00**  
Quantity per sheet 8



**ORD. NO. F PK 9600 00 00**  
Quantity per sheet 6



**PLAIN PARTITIONS FOR MULTIBOX**

The plain partitions of transparent polystyrene are fitted with label holders and can divide the multibox from 2 to 11 compartments depending on the model.

**Standard colour:**

■ TRANSPARENT F. ....96

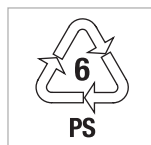
**PARTITION DIM. 100x90 mm h**

96

**ORD. NO.**

**F PK 7068 00 96**

**FOR BOXES**

F PK 0551 00 04  
F PK 1551 00 04  
F PK 3051 00 04

**PARTITION DIM. 145x90 mm h**

96

**ORD. NO.**

**F PK 7368 00 96**

**FOR BOXES**

F PK 1051 00 04  
F PK 2051 00 04  
F PK 3551 00 04  
F PK 4551 00 04

**PARTITION DIM. 225x90 mm h**

96

**ORD. NO.**

**F PK 7668 00 96**

**FOR BOXES**

F PK 2551 00 04  
F PK 4051 00 04

**MOBILE SAFETY LADDER**

**Standard colour:**

■ GREY RAL 7000 F. ....01



01

**ORD. NO. F CR 0800 00 01**

Upper tray.  
Dim. mm 200x545x180 h



■ The mobile safety ladder is supplied standard with 4 rubber swivel wheels without brakes.

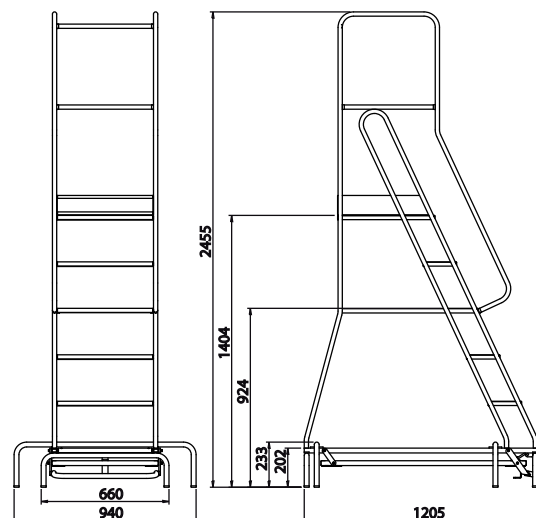

01

**ORD. NO. F CR 0300 00 01**

Mobile safety ladder.  
Load capacity 150 kg

4 the ladder can now be moved.



1 Press down on the first step...



2 the mobile safety ladder lowers to its block position.



3 Press the release pedal...



SHELVING SYSTEMS SYSTEM SV

SAFETY INFORMATION

WALL FIXING



When fixing shelving to the wall, one wall anchor with a force of **1.3 Kn** (including the safety coefficient) must be used for each upright frame.

FLOOR FIXING



When fixing shelving to the floor, one floor bolt with a force of **4.3 Kn** (including the safety coefficient) must be used for each foot plate.

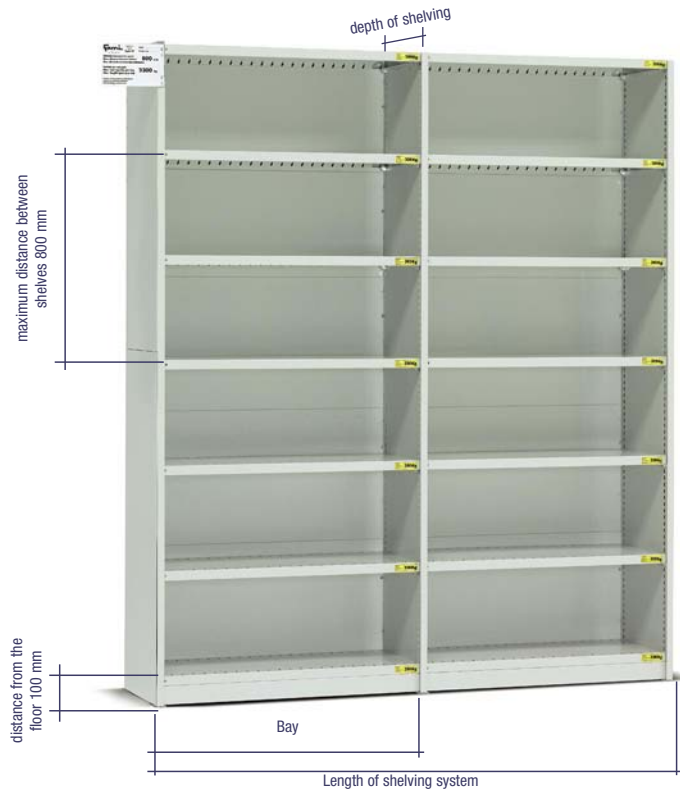

LOAD TABLE AND LABEL



Example of a **standard** load label for shelves

A load table is supplied **standard** with each shelving system and a load label is provided with each shelf or drawer.

- The load table must be attached to a perfectly visible part of the shelving. It shows both the load capacity for each bay and the maximum permitted distance between shelves.
- The load label must be applied to the front of each shelf or drawer.

P.S.: the sum of the load capacities of the shelves in each single bay must never exceed the overall load capacity of the bay indicated in the table.

LOAD LABEL IN SCREEN-PRINTED ALUMINIUM

When ordering a F SV shelving system, a load table in screen-printed aluminium complete with tabs for attaching it to the shelving may also be ordered.



Screen-printed load table for front

ORD. NO. F SV 9998 00 00

Position of the front table



Screen-printed load table for sides

ORD. NO. F SV 9999 00 00

Position of the side table



INSTRUCTIONS HANDBOOK

A complete and detailed instructions handbook is supplied standard with the shelving system. This contains the following information:

- technical data
- intended use
- safety information and residue risk areas
- technical table for calculating the required floor strength
- installation and assembly instructions
- fixing instructions.



shelving system series SV  
Shelving type Regal Serie

Anno di costruzione 2002  
Year of Manufacture  
Herstellungsjahr

Ordine n. / Order no. / Auftrag Nr. 12445

Distanza massima tra i piani  
Max. distance between shelves  
Max. Abstand zwischen den Fachböden

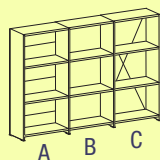
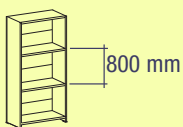

Portata per campata  
Max load capacity per bay  
Max. Tragfähigkeit pro Feld

- con parete posteriore  
A with back panel mit Rückwand 1000 Kg
- libera  
B free frei 700 Kg
- con crociera  
C with cross bracing mit Kreuzverbund 700 Kg

Carico uniformemente distribuito / Uniformly distributed load / Gleichmäßig verteilte Last

Example of a **standard** load table

LENGTH = 1000 / 1300 mm HEIGHT (H) = 2100 / 2350 / 2500 / 3100 mm h

## SERIES SYSTEM SV-DUAL DOCS



## FLOOR SET FIXING



Fixing material including no. 2 steel floor bolts M8x75 mm for uninterrupted concrete floors equal to or higher than class: B25 / RBK250 / MP. 25N for mm<sup>2</sup>.

ORD. NO. F NC 8999 00 99



## 1000 mm long single bay complete with foot plates and Allen keys

Depth of bay mm	Height of bay mm	Number of compartments for fileholders	Number of shelves per bay	For fileholders height mm	ORD. NO.
600	2100	5x2	6	320/350	F SV A210 61 08
600	2350	6x2	7	320	F SV A235 61 08
600	2500	6x2	7	350	F SV A250 61 08
600	3100	8x2	9	320	F SV A310 61 08

## 1000 mm long add-on bay complete with foot plates and Allen keys

Depth of bay mm	Height of bay mm	Number of compartments for fileholders	Number of shelves per bay	For fileholders height mm	ORD. NO.
600	2100	5x2	6	320/350	F SV C210 61 08
600	2350	6x2	7	320	F SV C235 61 08
600	2500	6x2	7	350	F SV C250 61 08
600	3100	8x2	9	320	F SV C310 61 08

## 1300 mm long single bay complete with foot plates and Allen keys

Depth of bay mm	Height of bay mm	Number of compartments for fileholders	Number of shelves per bay	For fileholders height mm	ORD. NO.
600	2100	5x2	6	320/350	F SV F210 61 08
600	2350	6x2	7	320	F SV F235 61 08
600	2500	6x2	7	350	F SV F250 61 08
600	3100	8x2	9	320	F SV F310 61 08

## 1300 mm long add-on bay complete with foot plates and Allen keys

Depth of bay mm	Height of bay mm	Number of compartments for fileholders	Number of shelves per bay	For fileholders height mm	ORD. NO.
600	2100	5x2	6	320/350	F SV H210 61 08
600	2350	6x2	7	320	F SV H235 61 08
600	2500	6x2	7	350	F SV H250 61 08
600	3100	8x2	9	320	F SV H310 61 08

## KEY



- Load capacity of each bay: **1000 kg**
- Load capacity of each shelf 1000 mm long: **120 kg**
- Load capacity of each shelf 1300 mm long: **100 kg**
- The shelving systems are supplied complete with foot plates and Allen key
- All indicated loads are net and refer to evenly distributed weights

Must be fixed to the floor

RAL 7035 F. .... 08



**SIDE PANELS**

ORD. NO.	For upright frames dim. mm
<b>F SV 2221 40 08</b>	400x2100
<b>F SV 2223 40 08</b>	400x2350
<b>F SV 2225 40 08</b>	400x2500
<b>F SV 2231 40 08</b>	400x3100

**WALL BRACKETS**



Made from galvanised steel, they are fitted onto the top of the uprights. They are shaped to keep the shelving system at a distance of 15 mm from the wall. Available galvanised only.

**ORD. NO. F ST 0710 00 99**

**FLOOR SET FIXING**



Fixing material including no. 2 steel floor bolts M8x75 mm for uninterrupted concrete floors equal to or higher than class: B25 / RBK250 / MP<sub>A</sub> 25N for mm<sup>2</sup>.

**ORD. NO. F NC 8999 00 99**

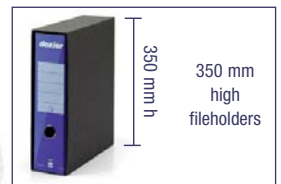
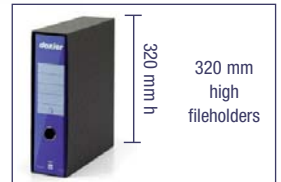

**1000 mm long single bay complete with base plinth, back panel, foot plates, wall brackets and Allen keys**

Depth of bay mm	Height of bay mm	Number of compartments for fileholders	Number of shelves per bay	For fileholders height mm	ORD. NO.
400	2100	5	6	320/350	<b>F SV D210 41 08</b>
400	2350	6	7	320	<b>F SV D235 41 08</b>
400	2500	6	7	350	<b>F SV D250 41 08</b>
400	3100	8	9	320	<b>F SV D310 41 08</b>

**1000 mm long add-on bay complete with base plinth, back panel, foot plates, wall brackets and Allen keys**

Depth of bay mm	Height of bay mm	Number of compartments for fileholders	Number of shelves per bay	For fileholders height mm	ORD. NO.
400	2100	5	6	320/350	<b>F SV E210 41 08</b>
400	2350	6	7	320	<b>F SV E235 41 08</b>
400	2500	6	7	350	<b>F SV E250 41 08</b>
400	3100	8	9	320	<b>F SV E310 41 08</b>

**1300 mm long single bay complete with base plinth, back panel, foot plates, wall brackets and Allen keys**

Depth of bay mm	Height of bay mm	Number of compartments for fileholders	Number of shelves per bay	For fileholders height mm	ORD. NO.
400	2100	5	6	320/350	<b>F SV L210 41 08</b>
400	2350	6	7	320	<b>F SV L235 41 08</b>
400	2500	6	7	350	<b>F SV L250 41 08</b>
400	3100	8	9	320	<b>F SV L310 41 08</b>

**1300 mm long add-on bay complete with base plinth, back panel, foot plates, wall brackets and Allen keys**

Depth of bay mm	Height of bay mm	Number of compartments for fileholders	Number of shelves per bay	For fileholders height mm	ORD. NO.
400	2100	5	6	320/350	<b>F SV M210 41 08</b>
400	2350	6	7	320	<b>F SV M235 41 08</b>
400	2500	6	7	350	<b>F SV M250 41 08</b>
400	3100	8	9	320	<b>F SV M310 41 08</b>

RAL 7035 F. ....08

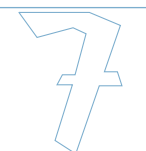

■ Load capacity of each bay: **1000 kg**

■ Load capacity of each shelf 1000 mm long: **120 kg**

■ Load capacity of each shelf 1300 mm long: **100 kg**

**KEY ■**

Must be fixed to the wall or floor

Must be fixed to the wall

■ All indicated loads are net and refer to evenly distributed weights



HEIGHT (H) = 320 / 350 mm

SHELVING SYSTEMS SYSTEM SV DOCS

LEAF DOORS



08



320 mm high fileholders



08



350 mm high fileholders



08

LEAF DOORS FOR 320/350 mm HIGH FILEHOLDERS

ORD. NO. DIM. LxH mm  
F SV 5200 10 08 1000x2000

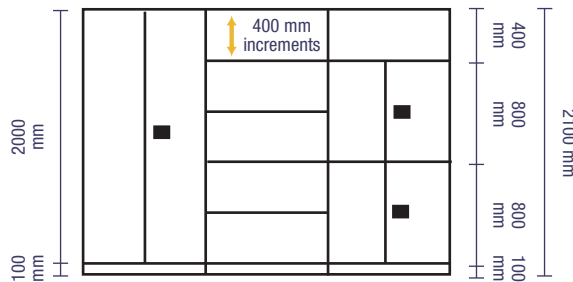

LEAF DOORS FOR 320/350 mm h HIGH FILEHOLDERS

ORD. NO. DIM. LxH mm  
F SV 5080 10 08 1000x800



LEAF DOORS FOR 320 mm h HIGH FILEHOLDERS

ORD. NO. DIM. LxH mm  
F SV 5225 10 08 1000x2250

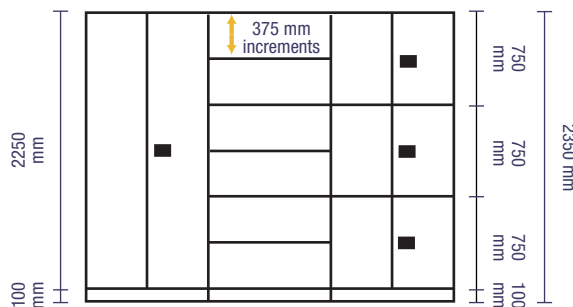

LEAF DOORS FOR 320 mm h HIGH FILEHOLDERS

ORD. NO. DIM. LxH mm  
F SV 5075 10 08 1000x750



LEAF DOORS FOR 350 mm h HIGH FILEHOLDERS

ORD. NO. DIM. LxH mm  
F SV 5200 10 08 1000x2000

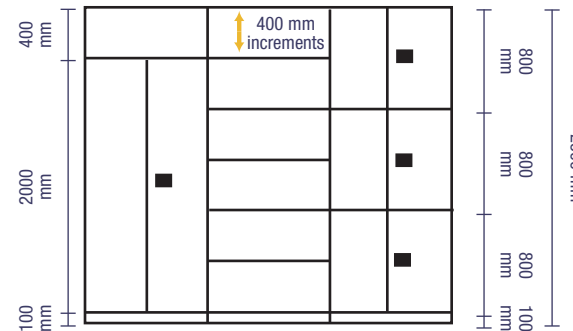

LEAF DOORS FOR 350 mm h HIGH FILEHOLDERS

ORD. NO. DIM. LxH mm  
F SV 5080 10 08 1000x800



LEAF DOORS FOR 320 mm h HIGH FILEHOLDERS

ORD. NO. DIM. LxH mm  
F SV 5225 10 08 1000x2250

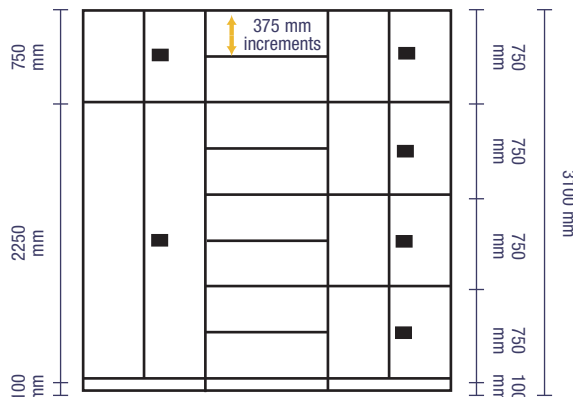

LEAF DOORS FOR 320 mm h HIGH FILEHOLDERS

ORD. NO. DIM. LxH mm  
F SV 5075 10 08 1000x750

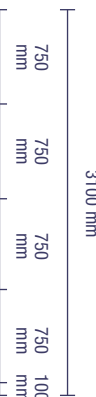



SHELVING SYSTEMS SYSTEM SV21

LENGTH = 1000 / 1300 mm

HEIGHT 2100 mm

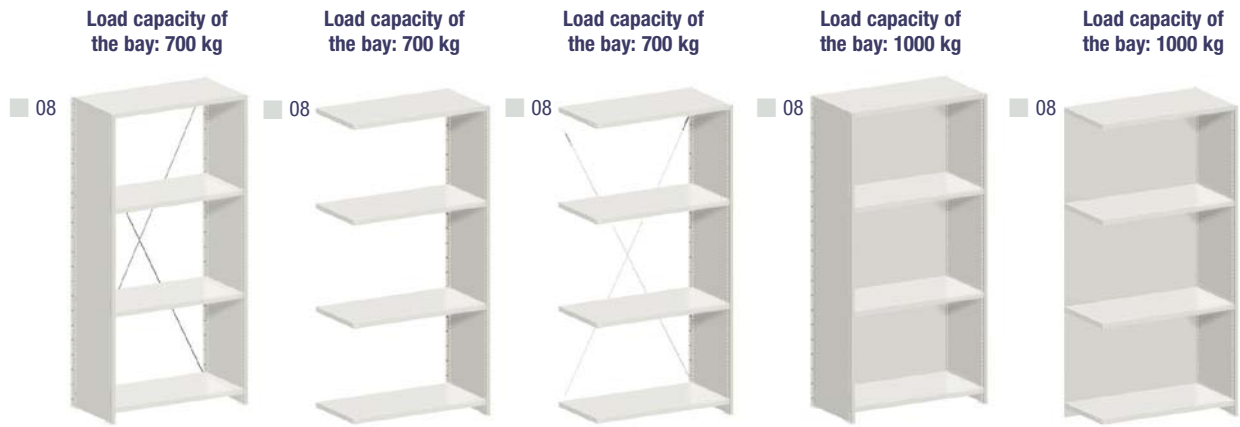

1000 mm LONG BAYS

Depth of bay mm	Single bay with cross bracing ORD. NO. galvanised	Add-on bay ORD. NO. galvanised	Add-on bay with cross bracing ORD. NO. galvanised	Single bay with back panel ORD. NO. galvanised	Add-on bay with back panel ORD. NO. galvanised
300	F SV A210 30 08	F SV B210 30 08	–	F SV D210 30 08	F SV E210 30 08
400	F SV A210 40 08	F SV B210 40 08	F SV C210 40 08	F SV D210 40 08	F SV E210 40 08
500	F SV A210 50 08	F SV B210 50 08	F SV C210 50 08	F SV D210 50 08	F SV E210 50 08
600	F SV A210 60 08	F SV B210 60 08	F SV C210 60 08	F SV D210 60 08	F SV E210 60 08

Each bay has 4 shelves. For 300 / 400 / 500 / 600 mm deep bays, the shelves are supplied without strengthening bars and have a load capacity of 120 kg.

1300 mm LONG BAYS

Depth of bay mm	Single bay with cross bracing ORD. NO. galvanised	Add-on bay ORD. NO. galvanised	Add-on bay with cross bracing ORD. NO. galvanised	Single bay with back panel ORD. NO. galvanised	Add-on bay with back panel ORD. NO. galvanised
300	F SV F210 30 08	F SV G210 30 08	–	F SV L210 30 08	F SV M210 30 08
400	F SV F210 40 08	F SV G210 40 08	F SV H210 40 08	F SV L210 40 08	F SV M210 40 08
500	F SV F210 50 08	F SV G210 50 08	F SV H210 50 08	F SV L210 50 08	F SV M210 50 08
600	F SV F210 60 08	F SV G210 60 08	F SV H210 60 08	F SV L210 60 08	F SV M210 60 08

Each bay has 4 shelves. For 300 / 400 / 500 / 600 mm deep bays, the shelves are supplied without strengthening bars and have a load capacity of 100 kg.

■ A cross bracing or a back panel must be fitted to each second bay (this does not apply to bays fixed to the wall)

■ For single shelving systems only single bays with cross bracings or back panels must be used.

**FLOOR SET FIXING**

Fixing material including no. 2 steel floor bolts M8x75 mm for uninterrupted concrete floors equal to or higher than class: B25 / RBK250 / MP<sub>A</sub> 25N for mm<sup>2</sup>.  
ORD. NO. F NC 8999 00 99

**WALL SET FIXING**

■ All the bays which must be fixed to the wall are supplied standard with wall brackets.

**FOOT PLATES FIXING**

■ The single bays are supplied with an Allen key for fixing the foot plates.

RAL 7035 F. .... 08



■ The bays are supplied unassembled complete with foot plates

■ Must be fixed to the floor or wall

KEY ■

- Must be fixed to the wall or floor
- Must be fixed to the wall

■ All indicated loads are net and refer to evenly distributed weights



LENGTH = 1000 / 1300 mm

## SHELVING SYSTEMS SYSTEM SV23

HEIGHT 2350 mm

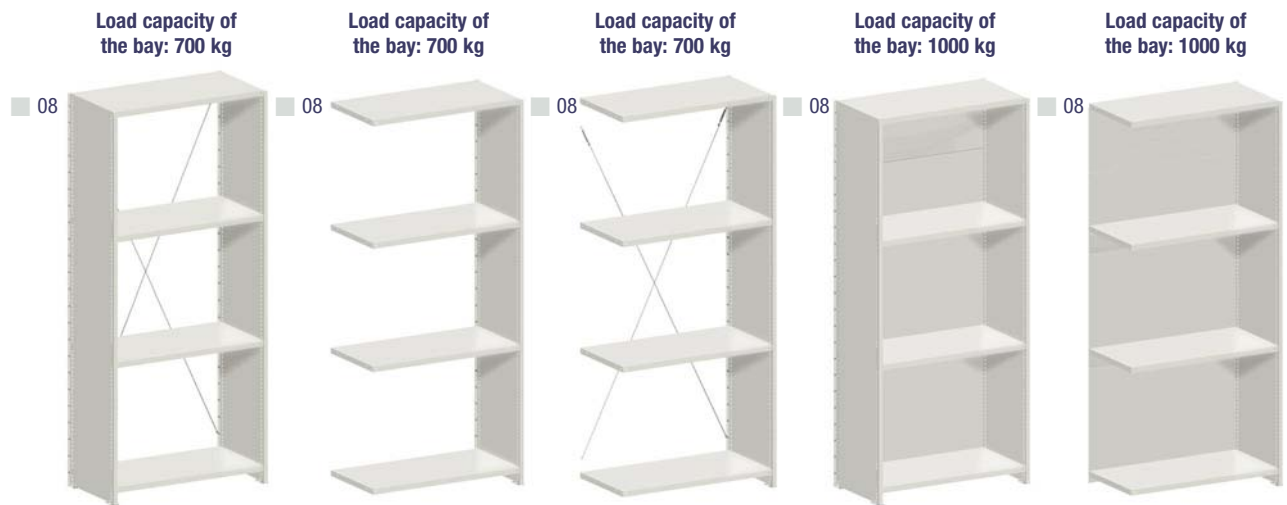

## 1000 mm LONG BAYS

Depth of bay mm	Single bay with cross bracing ORD. NO. galvanised	Add-on bay ORD. NO. galvanised	Add-on bay with cross bracing ORD. NO. galvanised	Single bay with back panel ORD. NO. galvanised	Add-on bay with back panel ORD. NO. galvanised
300	F SV A235 30 08	F SV B235 30 08	—	F SV D235 30 08	F SV E235 30 08
400	F SV A235 40 08	F SV B235 40 08	F SV C235 40 08	F SV D235 40 08	F SV E235 40 08
500	F SV A235 50 08	F SV B235 50 08	F SV C235 50 08	F SV D235 50 08	F SV E235 50 08
600	F SV A235 60 08	F SV B235 60 08	F SV C235 60 08	F SV D235 60 08	F SV E235 60 08

Each bay has 4 shelves. For 300 / 400 / 500 / 600 mm deep bays, the shelves are supplied without strengthening bars and have a load capacity of 120 kg.

## 1300 mm LONG BAYS

Depth of bay mm	Single bay with cross bracing ORD. NO. galvanised	Add-on bay ORD. NO. galvanised	Add-on bay with cross bracing ORD. NO. galvanised	Single bay with back panel ORD. NO. galvanised	Add-on bay with back panel ORD. NO. galvanised
300	F SV F235 30 08	F SV G235 30 08	—	F SV L235 30 08	F SV M235 30 08
400	F SV F235 40 08	F SV G235 40 08	F SV H235 40 08	F SV L235 40 08	F SV M235 40 08
500	F SV F235 50 08	F SV G235 50 08	F SV H235 50 08	F SV L235 50 08	F SV M235 50 08
600	F SV F235 60 08	F SV G235 60 08	F SV H235 60 08	F SV L235 60 08	F SV M235 60 08

Each bay has 4 shelves. For 300 / 400 / 500 / 600 mm deep bays, the shelves are supplied without strengthening bars and have a load capacity of 100 kg.



■ A cross bracing or a back panel must be fitted to each second bay (this does not apply to bays fixed to the wall)



■ For single shelving systems only single bays with cross bracings or back panels must be used.

## FLOOR SET FIXING



Fixing material including no. 2 steel floor bolts M8x75 mm for uninterrupted concrete floors equal to or higher than class: B25 / RBK250 / MP<sub>A</sub> 25N for mm<sup>2</sup>.  
ORD. NO. F NC 8999 00 99

## WALL SET FIXING



■ All the bays which must be fixed to the wall are supplied standard with wall brackets.

## FOOT PLATES FIXING



■ The single bays are supplied with an Allen key for fixing the foot plates.

## KEY



Must be fixed to the wall or floor



Must be fixed to the wall

■ All indicated loads are net and refer to evenly distributed weights

■ Must be fixed to the floor or wall

■ The bays are supplied unassembled complete with foot plates

RAL 7035 F. .... 08



SHELVING SYSTEMS SYSTEM SV

**UPRIGHT FRAMES 2100 / 2350 / 2500 / 3100 mm h**

Made of cold-pressed sheet steel, they feature 2 rows of slots with 25 mm increments for fixing the shelves and a row of slots at the rear with 100 mm increments for fixing other structural elements such as back panels and cross bracings. The 600 mm deep frames feature a third row of slots in the middle for fixing the diagonal strengtheners used to retain the fileholders. Available in grey Ral 7035.

**The upright frames are not supplied with foot plates.**

**FOOT PLATES**

■ 99



■ **Attention:** 2 foot plates are required for each upright frame

■ They are pressed into the lower end of the uprights and fixed with a screw complete with washer and nut. Made from **galvanised sheet steel**.

**ORD. NO. galvanised F SV 0700 00 99**

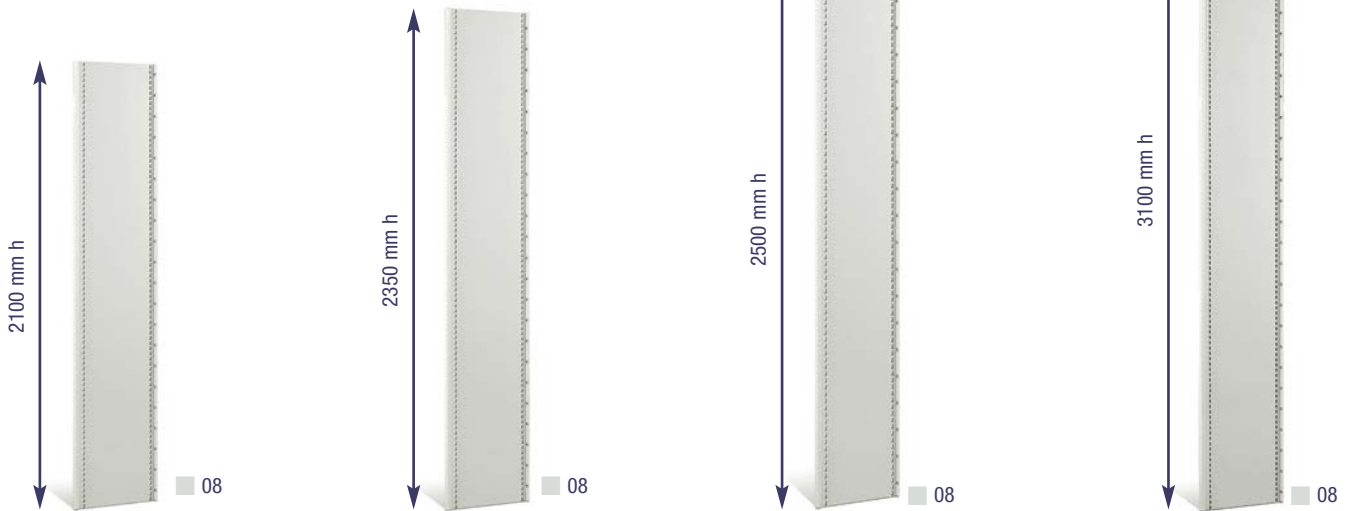

Depth of upright frame mm	ORD. NO.	Depth of upright frame mm	ORD. NO.	Depth of upright frame mm	ORD. NO.	Depth of upright frame mm	ORD. NO.
300	<b>F SV 0210 30 08</b>	300	<b>F SV 0235 30 08</b>	300	<b>F SV 0250 30 08</b>	300	<b>F SV 0310 30 08</b>
400	<b>F SV 0210 40 08</b>	400	<b>F SV 0235 40 08</b>	400	<b>F SV 0250 40 08</b>	400	<b>F SV 0310 40 08</b>
500	<b>F SV 0210 50 08</b>	500	<b>F SV 0235 50 08</b>	500	<b>F SV 0250 50 08</b>	500	<b>F SV 0310 50 08</b>
600	<b>F SV 0210 60 08</b>	600	<b>F SV 0235 60 08</b>	600	<b>F SV 0250 60 08</b>	600	<b>F SV 0310 60 08</b>

**WALL BRACKETS**



Made from galvanised steel, they are fitted to the top of the uprights. They are shaped to keep the shelving system at a distance of 15 mm from the wall. Available galvanised only.

**ORD. NO. F ST 0710 00 99**

**FLOOR SET FIXING**



Fixing material including no. 2 steel floor bolts M8x75 mm for uninterrupted concrete floors equal to or higher than class: B25 / RBK250 / MPa 25N for mm².

**ORD. NO. F NC 8999 00 99**

**CONNECTION SET FOR BACK TO BACK UPRIGHT FRAMES**



The clips are made of galvanised steel and are inserted into the rear of the upright frames. Each connection set includes 4 galvanised clips. **ORD. NO. F ST 0720 00 99**

RAL 7035 F. .... 08

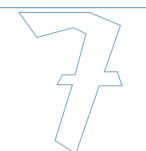

■ The upright frame **are not** supplied with foot plates

**KEY ■**



Must be fixed to the wall

This sign indicates that the upright frames have to be fixed to the wall by means of the fixing bracket ORD. NO. F ST 0710 00 99



LENGTH = 1000 / 1300 mm

## SHELVING SYSTEMS SYSTEM SV



■ All indicated loads are net and refer to evenly distributed weights

## 1000 mm LONG SLOTTED SHELVES

ORD. NO.	DIMENSIONS mm	NUMBER OF BARS	LOAD CAPACITY kg
F SV 1030 00 08	1000x300x35 h	–	120
F SV 1040 00 08	1000x400x35 h	–	120
F SV 1040 01 08	1000x400x35 h	1	300
F SV 1050 00 08	1000x500x35 h	–	120
F SV 1050 01 08	1000x500x35 h	1	300
F SV 1050 02 08	1000x500x35 h	2	400
F SV 1060 00 08	1000x600x35 h	–	120
F SV 1060 01 08	1000x600x35 h	1	300
F SV 1060 02 08	1000x600x35 h	2	400

## 1300 mm LONG SLOTTED SHELVES

ORD. NO.	DIMENSIONS mm	NUMBER OF BARS	LOAD CAPACITY kg
F SV 1130 00 08	1300x300x35 h	–	100
F SV 1140 00 08	1300x400x35 h	–	100
F SV 1140 01 08	1300x400x35 h	1	230
F SV 1150 00 08	1300x500x35 h	–	100
F SV 1150 01 08	1300x500x35 h	1	230
F SV 1150 02 08	1300x500x35 h	2	300
F SV 1160 00 08	1300x600x35 h	–	100
F SV 1160 01 08	1300x600x35 h	1	200
F SV 1160 02 08	1300x600x35 h	2	300

■ All indicated loads are net and refer to evenly distributed weights

## 1000 mm LONG STRENGTHENING BAR



ORD. NO. R FST 0005 99

## 1300 mm LONG STRENGTHENING BAR



ORD. NO. R FST 0006 99



## ■ Attention:

all shelves are supplied with 2 double hooks and 4 single hooks



■ Shelves in this series are supplied with load labels



Assembling the strengthening bar and the shelf

## SPARE CLIPS FOR SHELVES



ORD. NO. R FST 0003 99

Set of 4 spare galvanised clips



ORD. NO. R FST 0002 99

Set of 2 double spare galvanised clips



Using the magnetic support with label

## MAGNETIC SUPPORT WITH LABEL



ORD. NO. F ST 9997 00 00

Magnetic support with label and cellophane

ORD. NO. R FST 0007 00

Spare label and cellophane (100 pcs)

# SHELVING SYSTEMS SYSTEM SV

## BASE PLINTHS



■ 08

ORD. NO.	LENGTH mm
<b>F ST 7510 00 08</b>	<b>1000</b>
<b>F ST 7520 00 08</b>	<b>1300</b>

The base plinths are used to close the lower part of the shelving. They are assembled without screws and are available in two lengths: 1000 mm and 1300 mm. **Available grey Ral 7035.**

Assembling the base plinth



## LEAF DOORS

Each pair of leaf doors closes 1 bay. Available for 1000 mm long bays, they are easy to be assembled (just 4 screws are used for a pair of doors). The doors are supplied with a safety lock and 2 keys. **Available grey Ral 7035.**



■ 08

### FOOT PLATES FIXING



■ Allen key supplied standard



■ 08



■ This type of door closes 1 bay

ORD. NO.	DIMENSIONS LxH mm
<b>F SV 5200 10 08</b>	<b>1000x2000 h</b>
<b>F SV 5225 10 08</b>	<b>1000x2250 h</b>

ORD. NO.	DIMENSIONS LxH mm
<b>F SV 5075 10 08</b>	<b>1000x750 h</b>
<b>F SV 5080 10 08</b>	<b>1000x800 h</b>

## PLAIN SIDE PANELS

The side panels are connected to the upright frame with proper clips and without screws. **Available in grey Ral 7035.**

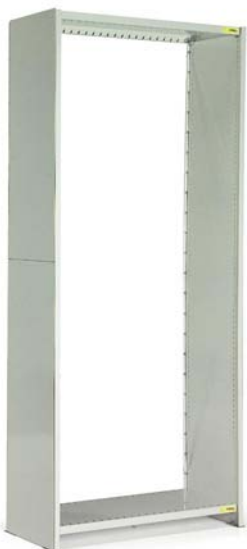

■ 08

ORD. NO.	FOR UPRIGHT FRAMES DIM. mm
<b>F SV 2221 30 08</b>	<b>300x2100 h</b>
<b>F SV 2221 40 08</b>	<b>400x2100 h</b>
<b>F SV 2221 50 08</b>	<b>500x2100 h</b>
<b>F SV 2221 60 08</b>	<b>600x2100 h</b>
<b>F SV 2223 30 08</b>	<b>300x2350 h</b>
<b>F SV 2223 40 08</b>	<b>400x2350 h</b>
<b>F SV 2223 50 08</b>	<b>500x2350 h</b>
<b>F SV 2223 60 08</b>	<b>600x2350 h</b>
<b>F SV 2225 30 08</b>	<b>300x2500 h</b>
<b>F SV 2225 40 08</b>	<b>400x2500 h</b>
<b>F SV 2225 50 08</b>	<b>500x2500 h</b>
<b>F SV 2225 60 08</b>	<b>600x2500 h</b>
<b>F SV 2231 30 08</b>	<b>300x3100 h</b>
<b>F SV 2231 40 08</b>	<b>400x3100 h</b>
<b>F SV 2231 50 08</b>	<b>500x3100 h</b>
<b>F SV 2231 60 08</b>	<b>600x3100 h</b>

Assembling the side panel



**SET OF 4 SPARE GALVANISED CLIPS FOR SIDE PANEL**

ORD. NO. R SV 0001 99



LENGTH = 1000 / 1300 mm

## SHELVING SYSTEMS SYSTEM SV

## CROSS BRACINGS

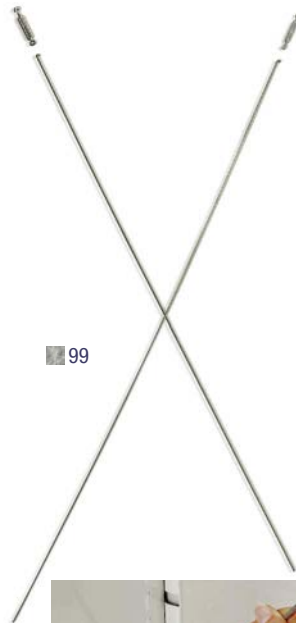
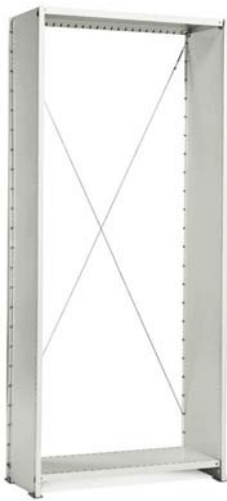

Assembling the cross bracing



ORD. NO. GALVANISED	DIM. PER BAY mm	DIM. LxH mm
F ST 7120 00 99	1000x2100	1000x2000
F ST 7122 00 99	1000x2350	1000x2200
F ST 7125 00 99	1000x2500	1000x2500
F ST 7220 00 99	1300x2100	1300x2000
F ST 7222 00 99	1300x2350	1300x2200
F ST 7225 00 99	1300x2500	1300x2500

The cross bracing is attached to the shelving from the front side without using screws. This system makes assembly easy especially if the shelving is positioned against the wall. **Available galvanised.**

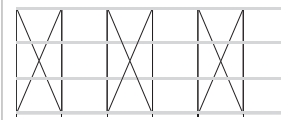

■ A cross bracing must be fitted to each second bay



■ A cross bracing must always be fitted to the single shelving system

## BACK PANELS



08



The back panels are also attached to the shelving from the front. No screws are used. This system makes assembly easy especially if the shelving is positioned against the wall. Supplied in various sections depending on the height of the shelving. **Available grey Ral 7035.**

ORD. NO.	DIM. LxH mm
F SV 2021 10 08	1000x2100
F SV 2023 10 08	1000x2350
F SV 2025 10 08	1000x2500
F SV 2031 10 08	1000x3100
F SV 2021 13 08	1300x2100
F SV 2023 13 08	1300x2350
F SV 2025 13 08	1300x2500
F SV 2031 13 08	1300x3100

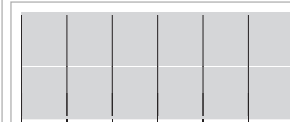
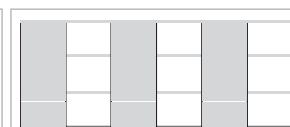
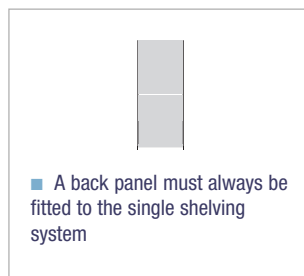

Assembling the back panel



## FULL EXTENSION SUSPENSION FOLDER FRAME FOR SUSPENSION FOLDER DIN A4

The suspension folder frames are supplied with full extension guide rails (100% extraction) with 30 Kg load capacity. Overall dimensions 990x400 mm. To insert the frame complete with suspension folders, make sure there is a minimum increment of 375 mm between shelves. **The frames can only be used for 1000 mm long and 400 mm deep bays.** Available in black Ral 9011.



ORD. NO. F SV 7840 00 07



# SHELVING SYSTEMS SYSTEM SV

## SHELF DIVIDERS

The shelf dividers are fitted into the shelf slots. They have a **standard height of 100 mm** and are supplied **galvanised**.

■ 99



ORD. NO. GALVANISED

DEPTH OF SHELVING mm

<b>F ST 9230 00 99</b>	<b>300</b>
<b>F ST 9240 00 99</b>	<b>400</b>
<b>F ST 9250 00 99</b>	<b>500</b>
<b>F ST 9260 00 99</b>	<b>600</b>

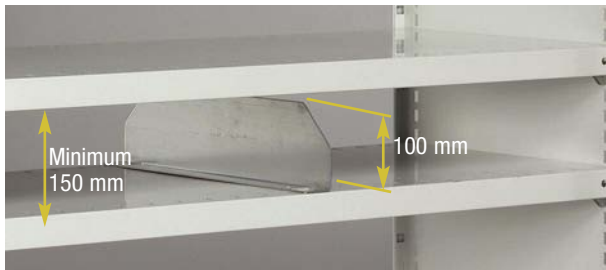

Assembling a shelf divider



## SHELF PANELS

The shelf panels are fitted into the slots between two shelves. They are available **galvanised** and in various heights ranging from 165 to 415 mm and in 4 different depths.

■ 99



Assembling a shelf panel

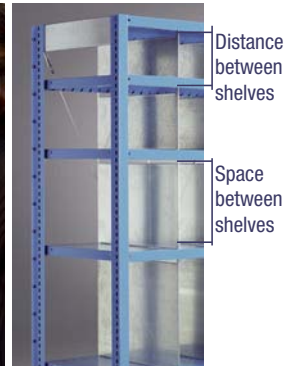

Space between shelves mm	Distance between shelves mm	Depth of shelving unit 300 mm ORD. NO. galvanised	Depth of shelving unit 400 mm ORD. NO. galvanised	Depth of shelving unit 500 mm ORD. NO. galvanised	Depth of shelving unit 600 mm ORD. NO. galvanised
165	200	<b>F ST 9000 00 99</b>	<b>F ST 9030 00 99</b>	<b>F ST 9060 00 99</b>	<b>F ST 9090 00 99</b>
215	250	<b>F ST 9005 00 99</b>	<b>F ST 9035 00 99</b>	<b>F ST 9065 00 99</b>	<b>F ST 9095 00 99</b>
265	300	<b>F ST 9010 00 99</b>	<b>F ST 9040 00 99</b>	<b>F ST 9070 00 99</b>	<b>F ST 9100 00 99</b>
315	350	<b>F ST 9015 00 99</b>	<b>F ST 9045 00 99</b>	<b>F ST 9075 00 99</b>	<b>F ST 9105 00 99</b>
365	400	<b>F ST 9020 00 99</b>	<b>F ST 9050 00 99</b>	<b>F ST 9080 00 99</b>	<b>F ST 9110 00 99</b>
415	450	<b>F ST 9025 00 99</b>	<b>F ST 9055 00 99</b>	<b>F ST 9085 00 99</b>	<b>F ST 9115 00 99</b>

DEPTH = 300 / 400 / 500 / 600 mm

## SHELVING SYSTEMS SYSTEM SV

## SET OF TROUGH PANELS AND TAPERED TROUGH DIVIDERS

Both trough panels are slotted in 50 mm increments to fit the tapered dividers. Assembly is quick and easy. **No screws are used.** The trough panels are available **grey Ral 7035**, while the tapered dividers are available **galvanised**.



## SET OF TROUGH PANELS WITH TWO TAPERED TROUGH DIVIDERS FOR 1000 mm LONG SHELVES

ORD. NO.	DEPTH mm
F ST 9510 30 55	300
F ST 9510 40 55	400
F ST 9510 50 55	500
F ST 9510 60 55	600

## SET OF TROUGH PANELS WITH TWO TAPERED TROUGH DIVIDERS FOR 1300 mm LONG SHELVES

ORD. NO.	DEPTH mm
F ST 9520 30 55	300
F ST 9520 40 55	400
F ST 9520 50 55	500
F ST 9520 60 55	600

## ADDITIONAL TAPERED TROUGH DIVIDER

ORD. NO.	DEPTH mm
F ST 9630 00 99	300
F ST 9640 00 99	400
F ST 9650 00 99	500
F ST 9660 00 99	600



Assembling the trough panels and the tapered trough dividers

## CONNECTING BAR BETWEEN SHELVING UNITS



ORD. NO.	GALVANISED	LENGTH mm
F SV 0820 00 99		800
F SV 0830 00 99		1000
F SV 0840 00 99		1250

## AISLES:

If the layout of the shelving system includes aisles, metal or mesh panels must be fitted on all the sides that are not used for picking up or setting down the material. These aisles must have the following widths:

- Aisles used for manually picking up or setting down material from the shelving without drawers. Manually pushed trolleys may not be used: minimum width 800 mm.
- Aisles used for picking up or setting down material from the shelving through manually pushed trolleys (shelving system with or without drawers): minimum width 1250 mm.
- Aisles used for staff transit: minimum width 1250 mm.

Aisles used for picking up or setting down material cannot be used for staff transit. If aisles are required to be used for the transit of powered trolleys, please contact FAMI for further details.

**Caution:** for back to back shelving, back panels, mesh back panels or shelf stoppers must be mounted between the two shelving units in order to prevent the material stored on one side of the shelving from being accidentally pushed to the other side when material is being set down.

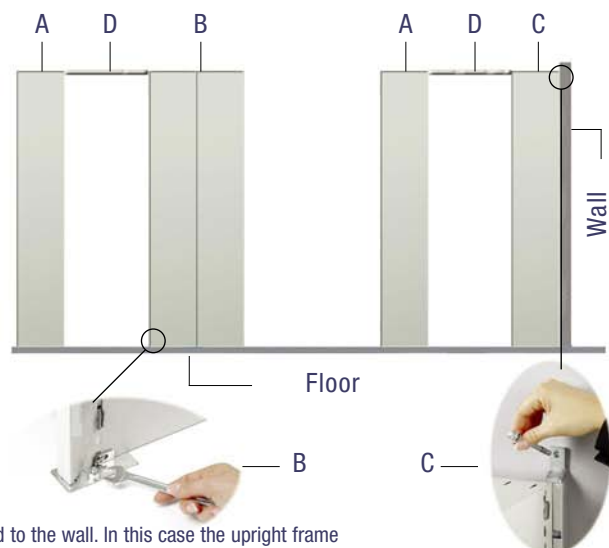
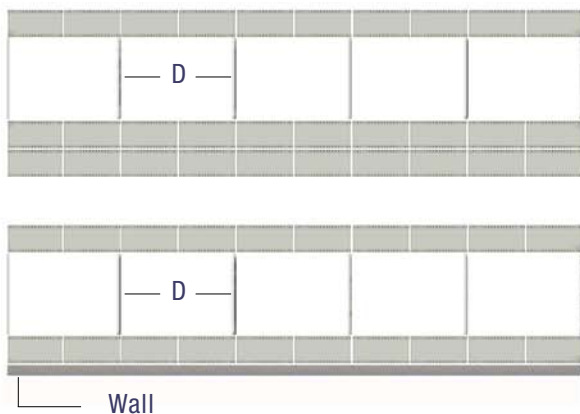

Caution: connection bars must be used for wall-fixed upright frames if these cannot be fixed to the wall. In this case the upright frame in question must be connected to a back to back upright frame which is either fixed to the floor or has one upright frame fixed to the wall.

To calculate the number of connection bars required to connect two shelving units, please see the above figure.

- The external upright frames must always be connected.
- The internal upright frames must be connected every two bays.

- A = Upright frame fixed with a connection bar.
- B = Back to back upright frames fixed to the floor.
- C = Single upright frame fixed to the wall.
- D = Upper safety connecting bar.



# SHELVING SYSTEMS SYSTEM SV

## GUIDE RAILS FOR MULTIBOX



■ 99

Assembling the guide rails for multibox



ORD. NO. GALVANISED	DEPTH OF SHELVING mm
F ST 9830 00 99	300
F ST 9840 00 99	400
F ST 9850 00 99	500
F ST 9860 00 99	600

■ Multibox  
see page G42

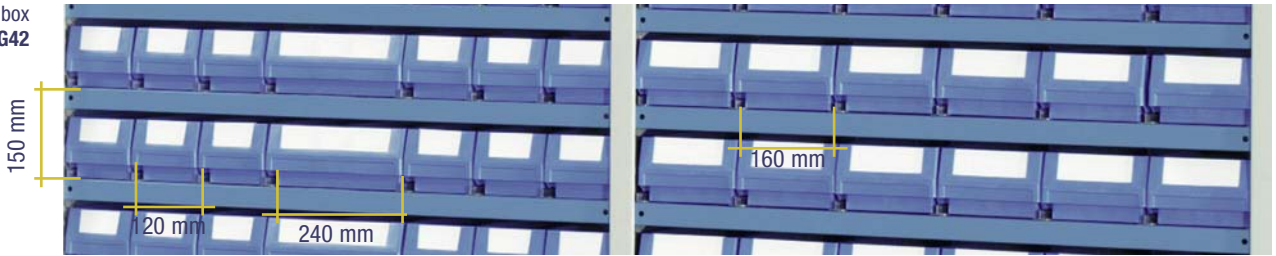

## SAFETY GUARDS FOR MULTIBOX BOXES

Made from galvanised sheet steel, the safety guards prevent the boxes from falling out by accident.

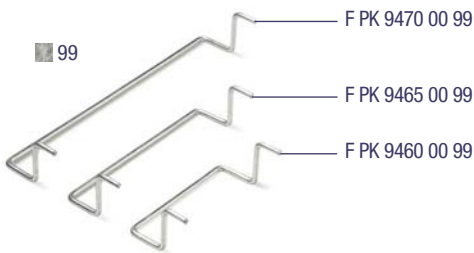

■ 99

Assembling the safety guards

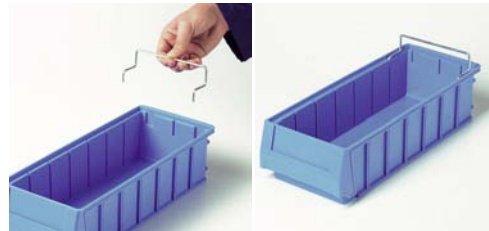

■ 99

**ORD. NO. F ST 9996 00 99**  
Set of 2 galvanised safety pins to tighten the shelves.

ORD. NO. GALVANISED	FOR BOXES	Ø mm
<b>F PK 9460 00 99</b>	F PK 0551 00 04	4,2
	F PK 1551 00 04	
	F PK 3051 00 04	
<b>F PK 9465 00 99</b>	F PK 1051 00 04	4,2
	F PK 2051 00 04	
	F PK 3551 00 04	
	F PK 4551 00 04	
<b>F PK 9470 00 99</b>	F PK 2551 00 04	4,2
	F PK 4051 00 04	



■ If Multibox containers are used with the shelving system, safety pins must be fitted on all the shelves in the system in order to prevent the upper shelf from coming loose if the Multibox is pushed down when open.

■ **Attention:** the strengthening bar can't be assembled on the shelves in which containers series multibox with safety guards are going to be inserted.

## MULTIBOX

Standard colour:

■ BLUE F. .... 04

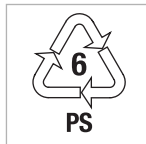

ORD. NO. GALVANISED	DIM. mm
<b>F PK 0551 00 04</b>	300x120x100 h
<b>F PK 1551 00 04</b>	400x120x100 h
<b>F PK 3051 00 04</b>	500x120x100 h



ORD. NO. GALVANISED	DIM. mm
<b>F PK 1051 00 04</b>	300x160x100 h
<b>F PK 2051 00 04</b>	400x160x100 h
<b>F PK 3551 00 04</b>	500x160x100 h
<b>F PK 4551 00 04</b>	600x160x100 h



ORD. NO. GALVANISED	DIM. mm
<b>F PK 2551 00 04</b>	400x240x100 h
<b>F PK 4051 00 04</b>	500x240x100 h

**ORD. NO. F PK 9540 00 00**

Quantity per sheet 12



**ORD. NO. F PK 9580 00 00**

Quantity per sheet 8



**ORD. NO. F PK 9600 00 00**

Quantity per sheet 6



DEPTH = 300 / 400 / 500 / 600 mm

## SHELVING SYSTEMS SYSTEM SV

## PLAIN PARTITIONS FOR MULTIBOX

The plain partitions of transparent polystyrene are fitted with label holders and can divide the multibox from 2 to 11 compartments depending on the model.



## Standard colour:

■ TRANSPARENT F. ....96



## PARTITION DIM. 100x90 mm h



■ 96

## ORD. NO.

F PK 7068 00 96

## FOR BOXES

F PK 0551 00 04  
F PK 1551 00 04  
F PK 3051 00 04

## PARTITION DIM. 145x90 mm h



■ 96

## ORD. NO.

F PK 7368 00 96

## FOR BOXES

F PK 1051 00 04  
F PK 2051 00 04  
F PK 3551 00 04  
F PK 4551 00 04

## PARTITION DIM. 225x90 mm h



■ 96

## ORD. NO.

F PK 7668 00 96

## FOR BOXES

F PK 2551 00 04  
F PK 4051 00 04

## MOBILE SAFETY LADDER

## Standard colour:

■ GREY RAL 7000 F. ....01



■ 01

ORD. NO. F CR 0800 00 01

Upper tray.  
Dim. mm 200x545x180 h



■ The mobile safety ladder is supplied standard with 4 rubber swivel wheels without brakes.

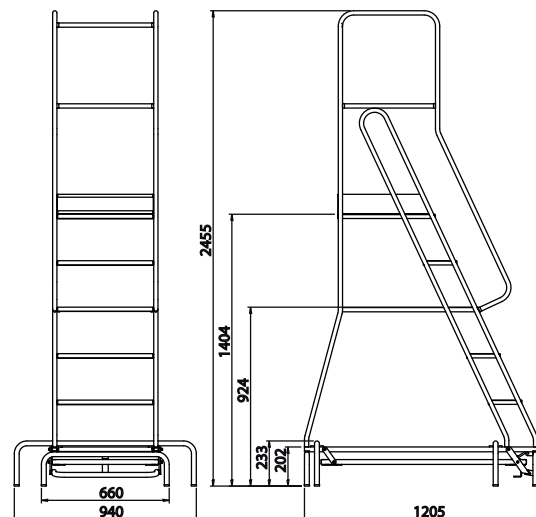

■ 01

ORD. NO. F CR 0300 00 01

Mobile safety ladder.  
Load capacity 150 kg

4 the ladder can now be moved.

1 Press down on the first step...

2 the mobile safety ladder lowers to its block position.

3 Press the release pedal...



SHELVING SYSTEM SYSTEM AR

SAFETY

**DOUBLE LOCKING SAFETY MECHANISM**

The shelving system is fitted with a double locking system to allow only one shelf to be pulled out at one time.  
 The anti-tilt system is based on a bar with safety catches fitted to each upright.  
 Each shelf is fitted with an individual safety catch.  
 The anti-tilt system prevents the movement of any stored items.



**RETRACTABLE SHELF CATCH**

The safety catch locks the shelf into normal or retracted position. This feature prevents the movement of the shelf during handling of stored items.



catch for normal extension shelves



catch for full extension shelves

**FLOOR SUPPORT PLATE**

The floor support plate distributes the weight pressure imposed by the upright onto the floor surface.  
 A technical chart showing flooring and surface requirements is supplied by FAMI.

The floor support plate has a fixing hole to allow anchorage to the floor with raw bolts supplied as standard. "Floor fixing" forms part of the basic safety requirements.

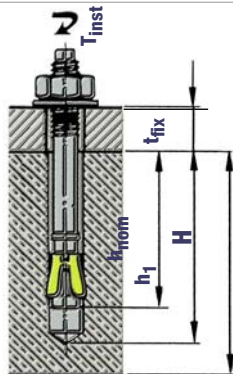

Recommended raw bolt tension ... 11,65 KN	Min. surface thickness for raw bolt fixing * ... H: 160 mm
Raw bolt diameter ..... Ø 16 mm	Min. distance of raw bolt from surface edge ..... B: 175 mm
Hole diameter in concrete ..... Ø 16 mm	Raw bolt influence area or centre distance ** ..... A: 112,5 mm
Minimum hole depth ..... h <sub>1</sub> 115 mm	Min dist. of upright from surface edge C: 75 mm
Minimum fitting depth ..... h <sub>nom</sub> 95 mm	
Max fixable thickness ..... t <sub>fix</sub> 25 mm	
Max torque setting ..... T <sub>inst</sub> 125 Nm	

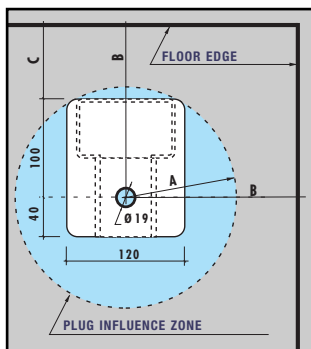

\* It is compulsory that the floor surface has sufficient strength to maintain the shelving weight and floor pressure. The surface must be of sufficient strength to allow for raw bolts to be fitted to the floor.  
 \*\* The area must remain free of any other force.

**SHELF LOAD CAPACITY**

A label stating load capacity for evenly distributed weight is fitted to each shelf.



Example of retractable shelf load label supplied as standard



Example of top shelf load label supplied as standard

**LOAD CAPACITY PER SINGLE BAY**

The shelving system is supplied with a weight loading table to ensure correct loading.

The table indicates:

- the type of shelving
- the year of manufacture
- manufacturer's internal reference number
- load capacity per bay excluding bay weight.



Example of a standard load table

**INSTRUCTIONS HANDBOOK**

A complete and detailed instructions handbook is supplied standard with the shelving system. This contains the following information:

- technical data
- intended use
- safety information and residue risk areas
- technical table for calculating the required floor strength
- installation and assembly instructions
- fixing instructions.



## TECHNICAL DATA

## SHELVING SYSTEM SYSTEM AR

## NORMAL EXTENSION

A: Shelving depth	900, 1100, 1300 mm
B: Bay width	1250 mm
C: Retractable extension	600, 750, 900 mm
D: Upright width	100 mm
E: Shelving height	1510, 2010, 2210, 2510, 3010 mm
F: Top shelf	50 mm
G: Adjustable pitch	50 mm
H: Retractable shelf thickness	58 mm
I: Min. distance from the floor	185 mm
L: Min. distance between shelves	300 mm
M: Min. span between shelves	225 mm
N: Foot plate	120 mm
O: Min. distance from top shelf	175 mm
R: Encumbrance	60 mm
Upright sheet steel thickness	3 mm

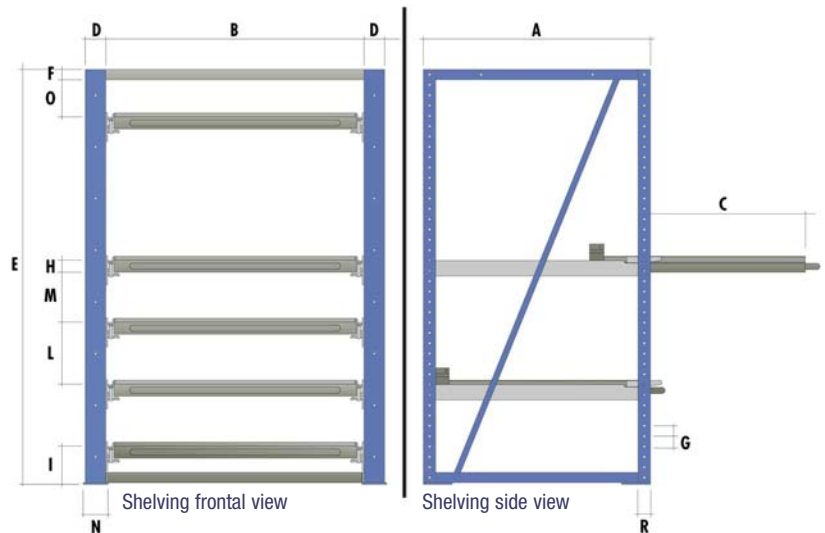

## FULL EXTENSION

A: Shelving depth	900, 1100, 1300 mm
B: Bay width	850, 1050, 1250 mm
C: Retractable extension	770, 970, 1170 mm
D: Upright width	100 mm
E: Shelving height	1510, 2010, 2210, 2510, 3010 mm
F: Top shelf	50 mm
G: Adjustable pitch	50 mm
H: Retractable shelf thickness	107 mm
I: Min. distance from the floor	285 mm
L: Min. distance between shelves	300 mm
M: Min. span between shelves	190 mm
N: Foot plate	120 mm
O: Min. distance from top shelf	50 mm
P: Slide height	80 mm
Q: Slide width	100 mm
R: Encumbrance	60 mm
Upright sheet steel thickness	3 mm

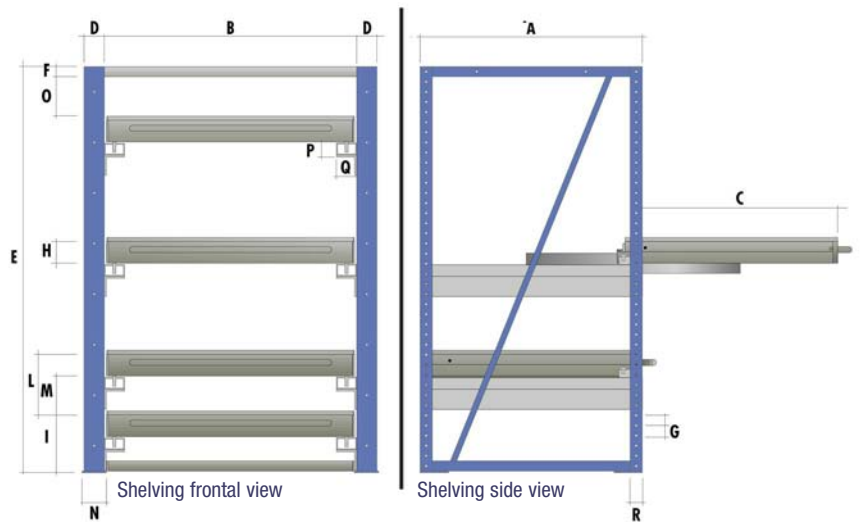

## ■ Combination of standard colours

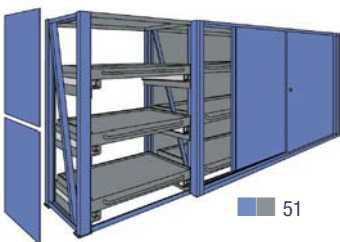

blue RAL 5012 + grey RAL 7000



green RAL 6011

## LOAD CAPACITY

- Single bay load capacity:..... 5000 Kg
- Full extension retractable shelf load capacity:..... 1000 Kg
- Normal extension retractable shelf load capacity:..... 800 Kg
- Top shelf load capacity for 900 mm depth:..... 300 Kg
- Top shelf load capacity for 1100 mm depth:..... 250 Kg
- Top shelf load capacity for 1300 mm depth:..... 200 Kg

## EXTRA FIXING SET FOR ONE UPRIGHT



Fixing material including no. 2 steel floor bolts M16x140 mm for uninter-rupted concrete floors equal to or higher than class: B25 / RBK250 / MPa 25N for mm<sup>2</sup>.

ORD. NO. F AR 8999 00 99

## ■ KEY



- All indicated loads are net and refer to evenly distributed weights

RAL 5012 +  
RAL 7000 F. ....51

RAL 6011 F. ....02



SHELVING SYSTEM SYSTEM AR

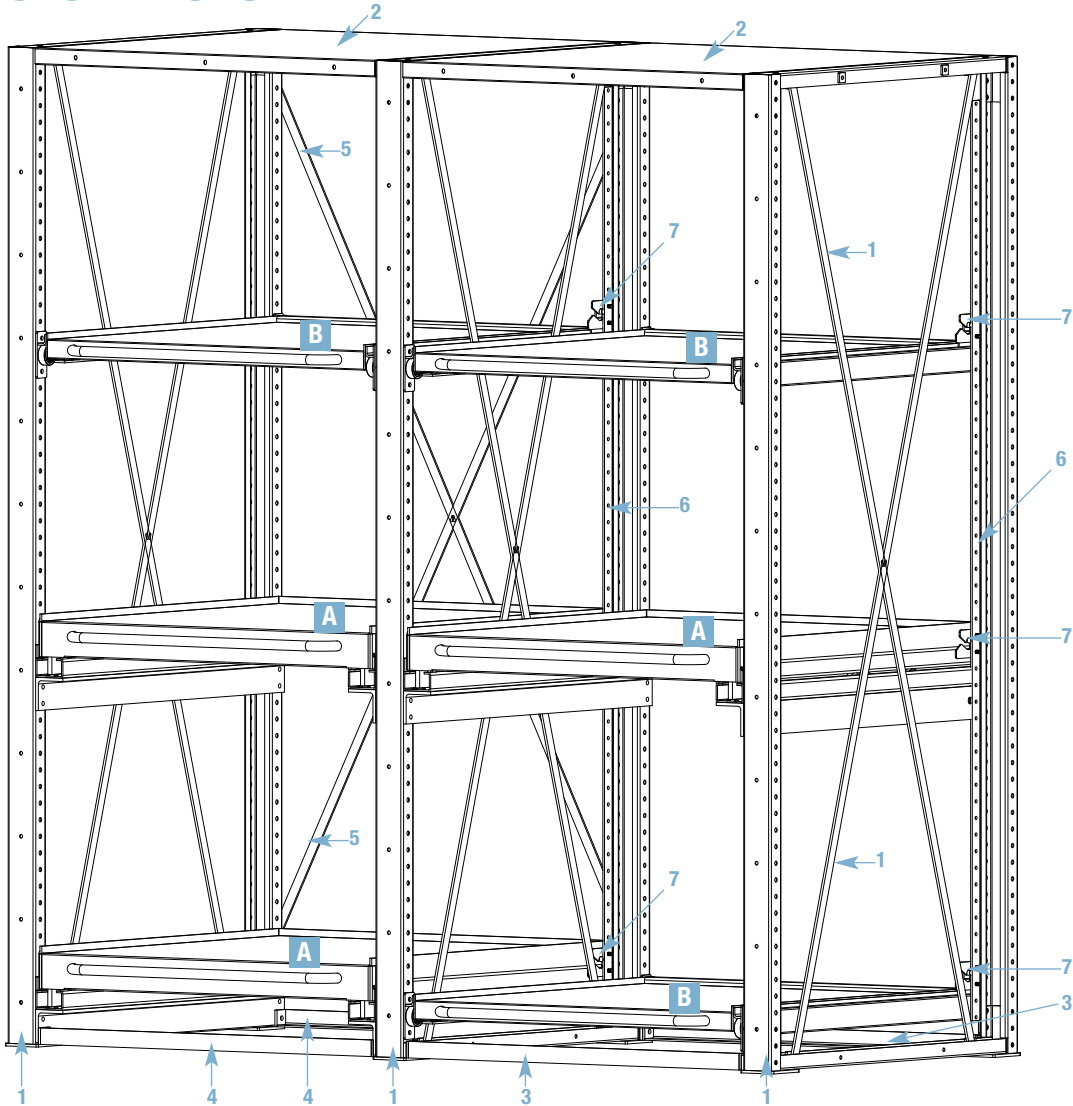

**A**  
Full extension shelf see page F38-F39

**B**  
Normal extension shelf see page F40

**1 UPRIGHTS** ■ 02 ■ 04

ORD. NO.	HEIGHT mm	DEPTH mm
F AR 2050 00 04	1510	900
F AR 2060 00 04	2010	
F AR 2070 00 04	2210	
F AR 2080 00 04	2510	
F AR 2090 00 04	3010	
F AR 2100 00 04	1510	1100
F AR 2110 00 04	2010	
F AR 2120 00 04	2210	
F AR 2130 00 04	2510	
F AR 2140 00 04	3010	
F AR 2150 00 04	1510	1300
F AR 2160 00 04	2010	
F AR 2170 00 04	2210	
F AR 2180 00 04	2510	
F AR 2190 00 04	3010	

Fixing materials composed by 2 expanding steel screws M16x140 supplied as standard. Bays supplied unassembled.

**2 TOP SHELVES** ■ 01 ■ 02

ORD. NO.	LOAD CAPACITY kg	DIMENSIONS mm
F AR 4020 00 01	300	850x900x50 h
F AR 4030 00 01	250	850x1100x50 h
F AR 4040 00 01	200	850x1300x50 h
F AR 4120 00 01	300	1050x900x50 h
F AR 4130 00 01	250	1050x1100x50 h
F AR 4140 00 01	200	1050x1300x50 h
F AR 4220 00 01	300	1250x900x50 h
F AR 4230 00 01	250	1250x1100x50 h
F AR 4240 00 01	200	1250x1300x50 h

■ The shelves in this series are supplied with load labels.



**EXTRA FIXING SET FOR ONE UPRIGHT**

Fixing material including no. 2 steel floor bolts M16x140 mm for uninterrupted concrete floors equal to or higher than class: B25 / RBK250 / MP<sub>A</sub> 25N for mm<sup>2</sup>.

ORD. NO. F AR 8999 00 99

RAL 7000 F. ....01 ■ RAL 6011 F. ....02 ■ RAL 5012 F. ....04 ■

**KEY** ■

- Spare fixing set for one upright see page F35
- All indicated loads are net and refer to evenly distributed weights



DEPTH = 900 / 1100 / 1300 mm

## SHELVING SYSTEM SYSTEM AR

**3 HORIZONTAL DISTANCE TIE BARS FOR NORMAL EXTENSION SHELVES**

ORD. NO.	BAY WIDTH mm
F AR 1040 00 01	1250

2 bars for each bay are needed



■ 01 ■ 02

**4 HORIZONTAL DISTANCE TIE BARS FOR FULL EXTENSION SHELVES**

ORD. NO.	BAY WIDTH mm
F AR 1010 00 01	850
F AR 1020 00 01	1050
F AR 1030 00 01	1250

2 bars for each bay are needed



■ 01 ■ 02

**5 CROSS BRACING**

ORD. NO.	HEIGHT UPRIGHT mm	BAY WIDTH mm
F AR 1850 00 01	1510	850
F AR 1860 00 01	2010	
F AR 1870 00 01	2210	
F AR 1880 00 01	2510	
F AR 1890 00 01	3010	1050
F AR 1900 00 01	1510	
F AR 1910 00 01	2010	
F AR 1920 00 01	2210	
F AR 1930 00 01	2510	1250
F AR 1940 00 01	3010	
F AR 1950 00 01	1510	
F AR 1960 00 01	2010	
F AR 1970 00 01	2210	1250
F AR 1980 00 01	2510	
F AR 1990 00 01	3010	

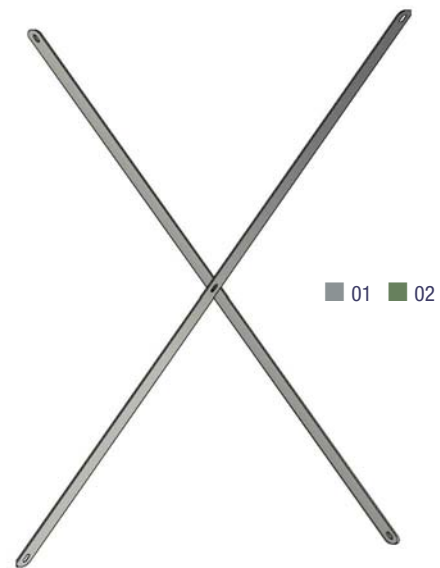

■ 01 ■ 02

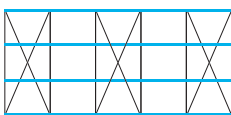

■ A cross bracing must be fitted to each second bay

**SINGLE DRAWER OPENING SYSTEM**

The single drawer opening system forms a standard part of this shelving system. The system prevents the operator from retracting more than one shelf at one time. The system comprises a locking bar as the same height of the upright and one locking catch per retractable shelf. Each bay requires one locking bar and one safety catch per retractable shelf (**hooks are standard supplied with the retractable shelf**). Standard colours grey Ral 7000 or green Ral 6011.

**6 BAR**

ORD. NO.	UPRIGHT HEIGHT mm
F AR 1100 00 01	1510
F AR 1110 00 01	2010
F AR 1120 00 01	2210
F AR 1130 00 01	2510
F AR 1140 00 01	3010



■ 01 ■ 02

**7 LOCKING CATCH**

■ Locking catch are standard supplied with the retractable shelf

■ INFO

RAL 7000 F. ....01 RAL 6011 F. ....02

[www.famispa.com](http://www.famispa.com)

SHELVING SYSTEM SYSTEM AR

FOR BAY 850 / 1050 / 1250 mm WIDTH

**A FULL EXTENSION SHELVES WITH 3 EDGES**

**FOR BAY 850 mm WIDTH**

ORD. NO.	Bay width mm	Shelf depth mm	Usable width mm	Usable depth mm	Extension mm
F AR 7400 00 01	850	900	805	845	770
F AR 7410 00 01	850	1100	805	1045	970
F AR 7420 00 01	850	1300	805	1245	1170

Load capacity: 1000 kg

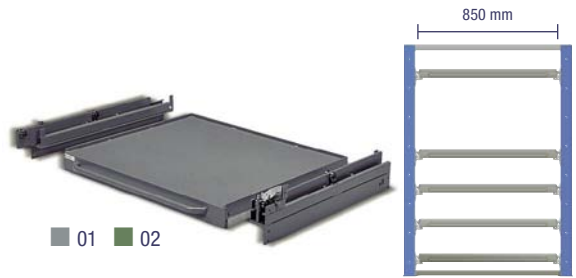

**FOR BAY 1050 mm WIDTH**

ORD. NO.	Bay width mm	Shelf depth mm	Usable width mm	Usable depth mm	Extension mm
F AR 7500 00 01	1050	900	1005	845	770
F AR 7510 00 01	1050	1100	1005	1045	970
F AR 7520 00 01	1050	1300	1005	1245	1170

Load capacity: 1000 kg

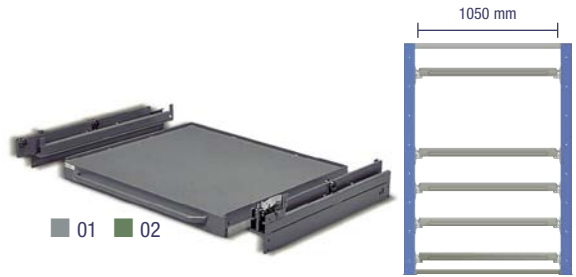

**FOR BAY 1250 mm WIDTH**

ORD. NO.	Bay width mm	Shelf depth mm	Usable width mm	Usable depth mm	Extension mm
F AR 7600 00 01	1250	900	1205	845	770
F AR 7610 00 01	1250	1100	1205	1045	970
F AR 7620 00 01	1250	1300	1205	1245	1170

Load capacity: 1000 kg

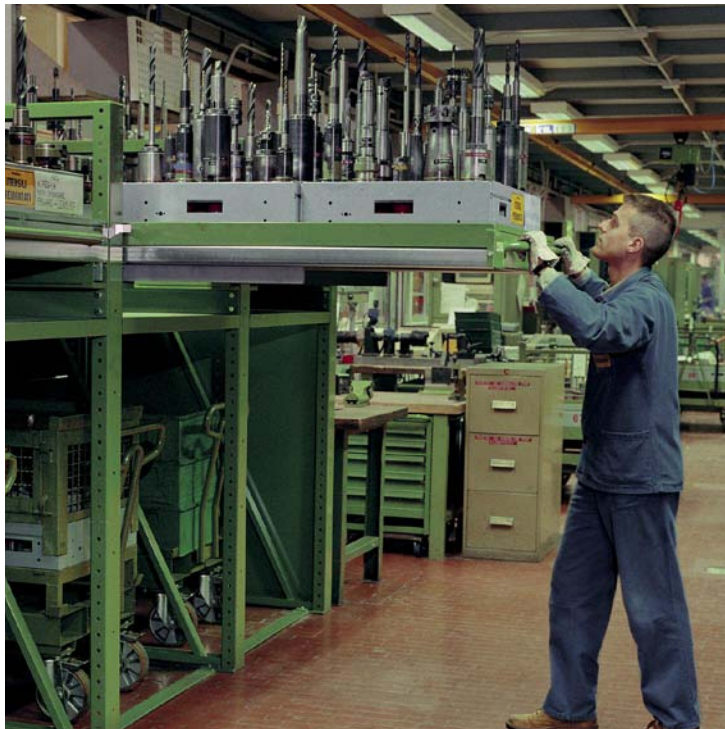
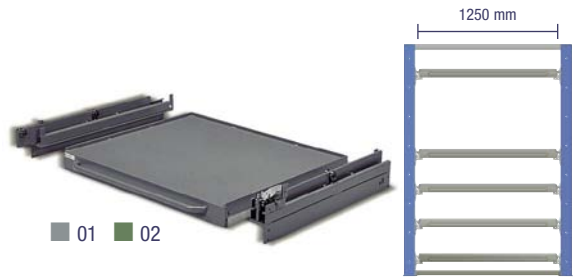

■ The extension shelves in this series are supplied with **load labels**.



RAL 7000 F. ....01 RAL 6011 F. ....02



**KEY ■**

■ All indicated loads are net and refer to evenly distributed weights



FOR BAY 850 / 1050 / 1250 mm WIDTH

## SHELVING SYSTEM SYSTEM AR

## A FULL EXTENSION SHELVES WITH 4 EDGES

## FOR BAY 850 mm WIDTH

ORD. NO.	Bay width mm	Shelf depth mm	Usable width mm	Usable depth mm	Extension mm
F AR 7450 00 01	850	900	805	845	770
F AR 7460 00 01	850	1100	805	1045	970
F AR 7470 00 01	850	1300	805	1245	1170

Load capacity: 1000 kg



■ 01 ■ 02



## FOR BAY 1050 mm WIDTH

ORD. NO.	Bay width mm	Shelf depth mm	Usable width mm	Usable depth mm	Extension mm
F AR 7550 00 01	1050	900	1005	845	770
F AR 7560 00 01	1050	1100	1005	1045	970
F AR 7570 00 01	1050	1300	1005	1245	1170

Load capacity: 1000 kg



■ 01 ■ 02



## FOR BAY 1250 mm WIDTH

ORD. NO.	Bay width mm	Shelf depth mm	Usable width mm	Usable depth mm	Extension mm
F AR 7650 00 01	1250	900	1205	845	770
F AR 7660 00 01	1250	1100	1205	1045	970
F AR 7670 00 01	1250	1300	1205	1245	1170

Load capacity: 1000 kg



■ 01 ■ 02



## A FULL EXTENSION SHELVES WITH 4 SIDES AND MULTIPLEX WOODEN TOP

## FOR BAY 850 mm WIDTH

ORD. NO.	Bay width mm	Shelf depth mm	Usable width mm	Usable depth mm	Extension mm
F AR 7450 01 01	850	900	805	845	770
F AR 7460 01 01	850	1100	805	1045	970
F AR 7470 01 01	850	1300	805	1245	1170

Load capacity: 1000 kg

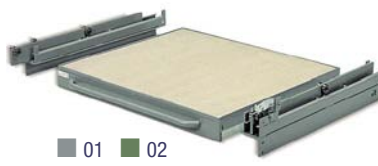

■ 01 ■ 02



## FOR BAY 1050 mm WIDTH

ORD. NO.	Bay width mm	Shelf depth mm	Usable width mm	Usable depth mm	Extension mm
F AR 7550 01 01	1050	900	1005	845	770
F AR 7560 01 01	1050	1100	1005	1045	970
F AR 7570 01 01	1050	1300	1005	1245	1170

Load capacity: 1000 kg

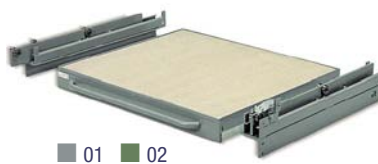

■ 01 ■ 02



## FOR BAY 1250 mm WIDTH

ORD. NO.	Bay width mm	Shelf depth mm	Usable width mm	Usable depth mm	Extension mm
F AR 7650 01 01	1250	900	1205	845	770
F AR 7660 01 01	1250	1100	1205	1045	970
F AR 7670 01 01	1250	1300	1205	1245	1170

Load capacity: 1000 kg



■ 01 ■ 02





## SHELVING SYSTEM SYSTEM AR

**B** NORMAL EXTENSION SHELVES WITH 3 EDGES

## FOR BAY 1250 mm WIDTH

ORD. NO.	Bay width mm	Shelf depth mm	Usable width mm	Usable depth mm	Extension mm
F AR 6600 00 01	1250	900	1160	800	600
F AR 6610 00 01	1250	1100	1160	1000	750
F AR 6620 00 01	1250	1300	1160	1200	900

Load capacity: 800 kg



■ 01 ■ 02

**B** NORMAL EXTENSION SHELVES WITH 4 EDGES

## FOR BAY 1250 mm WIDTH

ORD. NO.	Bay width mm	Shelf depth mm	Usable width mm	Usable depth mm	Extension mm
F AR 6650 00 01	1250	900	1160	800	600
F AR 6660 00 01	1250	1100	1160	1000	750
F AR 6670 00 01	1250	1300	1160	1200	900

Load capacity: 800 kg



■ 01 ■ 02

**B** NORMAL EXTENSION SHELVES WITH 4 SIDES AND MULTIPLEX WOODEN TOP

## FOR BAY 1250 mm WIDTH

ORD. NO.	Bay width mm	Shelf depth mm	Usable width mm	Usable depth mm	Extension mm
F AR 6650 01 01	1250	900	1160	800	600
F AR 6660 01 01	1250	1100	1160	1000	750
F AR 6670 01 01	1250	1300	1160	1200	900

Load capacity: 800 kg

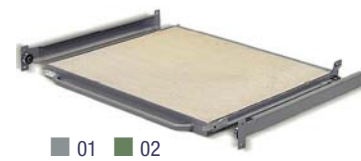

■ 01 ■ 02



## BACK PANELS

ORD. NO.	Shelving height mm	Back panel consisting of sections no.	Bay width mm
F AR 1450 00 01	1510	1	850
F AR 1460 00 01	2010	2	
F AR 1470 00 01	2210	2	
F AR 1480 00 01	2510	2	
F AR 1490 00 01	3010	2	
F AR 1500 00 01	1510	1	1050
F AR 1510 00 01	2010	2	
F AR 1520 00 01	2210	2	
F AR 1530 00 01	2510	2	
F AR 1540 00 01	3010	2	
F AR 1550 00 01	1510	1	1250
F AR 1560 00 01	2010	2	
F AR 1570 00 01	2210	2	
F AR 1580 00 01	2510	2	
F AR 1590 00 01	3010	2	

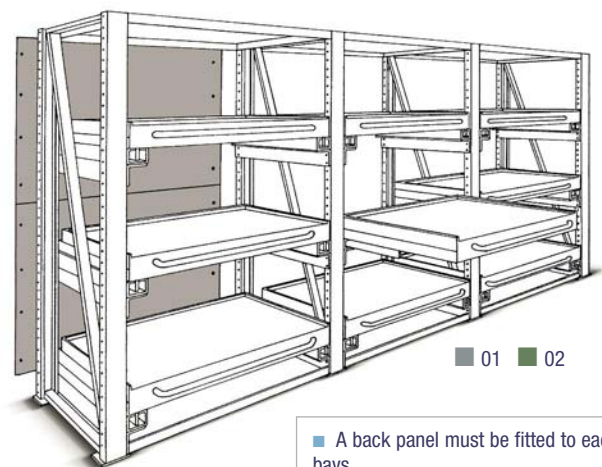

■ 01 ■ 02

■ A back panel must be fitted to each 2 bays

RAL 7000 F. ....01 RAL 6011 F. ....02

## KEY ■

■ All indicated loads are net and refer to evenly distributed weights



HEIGHT 1510 / 2010 / 2210 / 2510 / 3010 mm

## SHELVING SYSTEM SYSTEM AR

## SIDE PANELS

ORD. NO.	Shelving height mm	Side panel required q.ty of sections	Bay width mm
F AR 1250 00 04	1510	1	900
F AR 1260 00 04	2010	2	
F AR 1270 00 04	2210	2	
F AR 1280 00 04	2510	2	
F AR 1290 00 04	3010	2	
F AR 1300 00 04	1510	1	1100
F AR 1310 00 04	2010	2	
F AR 1320 00 04	2210	2	
F AR 1330 00 04	2510	2	
F AR 1340 00 04	3010	2	1300
F AR 1350 00 04	1510	1	
F AR 1360 00 04	2010	2	
F AR 1370 00 04	2210	2	
F AR 1380 00 04	2510	2	
F AR 1390 00 04	3010	2	

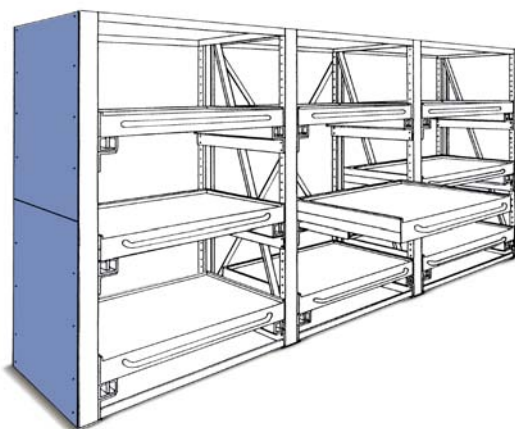

## SLIDING DOORS

ORD. NO.	Shelving height mm	Shelf thickness mm	Bay width mm	Shelving width mm
F AR 5000 00 04	1510	165	850	1900
F AR 5050 00 04	2010	165		
F AR 5100 00 04	2210	165		
F AR 5150 00 04	2510	165		
F AR 5200 00 04	3010	165		
F AR 5250 00 04	1510	165	1050	2300
F AR 5300 00 04	2010	165		
F AR 5350 00 04	2210	165		
F AR 5400 00 04	2510	165		
F AR 5450 00 04	3010	165	1250	2700
F AR 5500 00 04	1510	165		
F AR 5550 00 04	2010	165		
F AR 5600 00 04	2210	165		
F AR 5650 00 04	2510	165		
F AR 5700 00 04	3010	165		

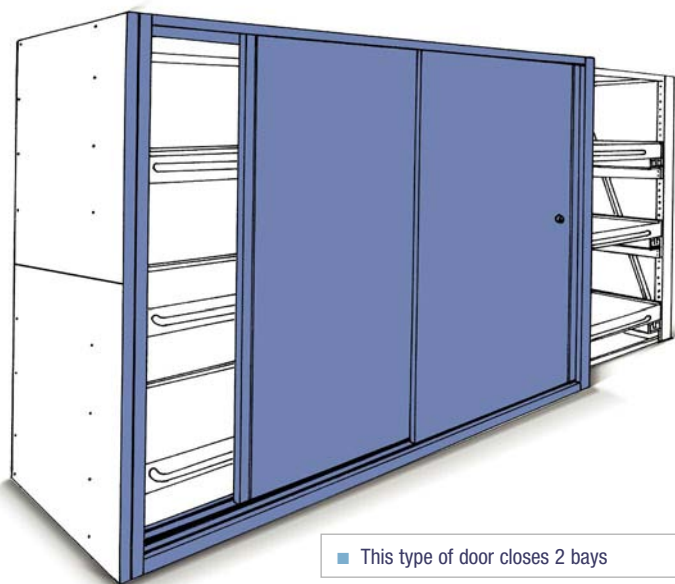

■ This type of door closes 2 bays

Supplied with cylinder lock and 2 keys.



## ■ SUPPLEMENTARY PARTS



■ **Spare key.** Always indicate the number on the cylinder lock of the key to be replaced.

ORD. NO. R CSC 0002 00

■ **Master key.** This type of key opens all the 45 and 46 series locks.

ORD. NO. R CSC 0001 00



RAL 6011 F. ....02 RAL 5012 F. ....04



SHELVING SYSTEM SYSTEM SR



**INSTRUCTIONS HANDBOOK**

A complete and detailed instructions handbook is supplied standard with the shelving system.

This contains the following information:

- technical data
- intended use
- safety information and residue risk areas
- technical table for calculating the required floor strenght
- installation and assembly instructions
- fixing instructions.



**LOAD TABLE**

A load table is supplied **on request** with each shelving system.

The load table must be attached to a perfectly visible part of the shelving and shows:

- load capacity per bay
- load capacity of shelves and drawers
- max. distance between universal shelves
- max. distance between locking shelves

Example of load capacity table **supplied on request**

<b>fami</b> <small>www.famitpa.com</small>	Scaffalatura serie Shelving type Regal Serie	ST	Anno di costruzione Year of Manufacture Herstellungsjahr	2002
	Ordine n. / Order no. / Auftrag Nr.			12445
<b>Max distance between universal shelves</b>		<b>1000 mm</b>		
<b>Load capacity per bay</b>		<b>5500 kg</b>		
<b>Load capacity of universal shelves</b>		<b>200 kg</b>		
<b>Load capacity of locking shelves</b>		<b>200 kg</b>		
<b>Load capacity of drawers</b>		<b>200 kg</b>		
<small>Carico uniformemente distribuito / Uniformly distributed load / Gleichmäßig verteilte Last</small>				

RAL 7000 F. ....01   RAL 6011 F. ....02   RAL 5012 F. ....04   RAL 7035 F. ....08

**SUPPLEMENTARY PARTS ■**

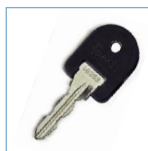
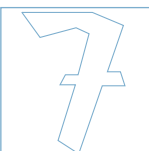

■ **Spare key.** Always indicate the number on the cylinder lock of the key to be replaced.

ORD. NO. R CSC 0002 00

■ **Master key.** This type of key opens all the 45 and 46 series locks.

ORD. NO. R CSC 0001 00





SHELVING SYSTEM SYSTEM SR 3627

LENGTH = 714 mm DEPTH = 553 mm (36x27 Eh)

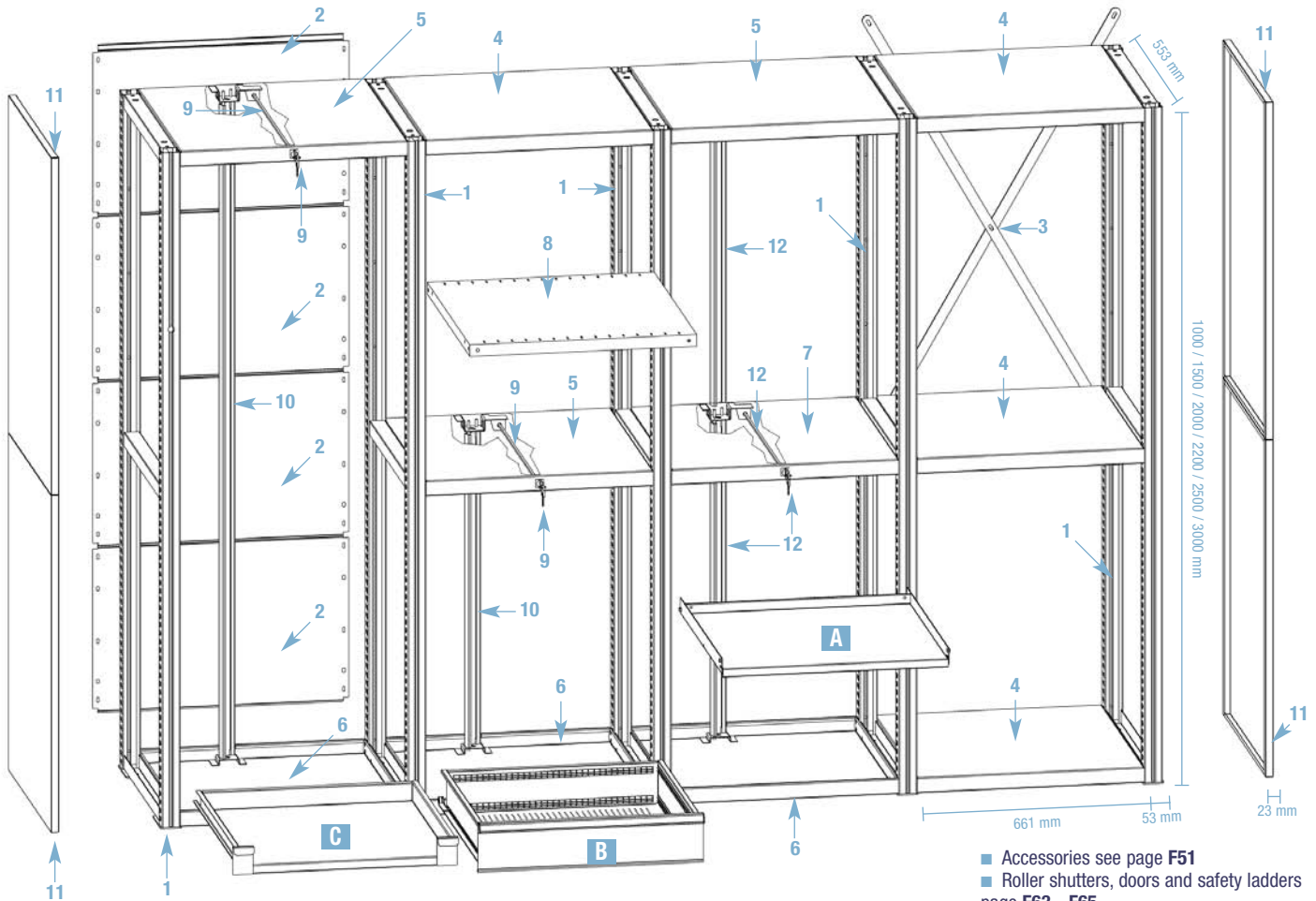

- Accessories see page F51
- Roller shutters, doors and safety ladders page F63 - F65

**FIXING SET**



Fixing material including (for 1 upright frame) no. 2 steel floor bolts M10x90 mm for uninterrupted concrete floors equal to or higher than class: B25 / RBK250 / MP<sub>A</sub> 25N for mm<sup>2</sup>.

ORD. NO. F SR 8999 00 99

- Shelving must be fixed to the wall or floor.

**LOAD CAPACITY PER BAY**

Load capacity per bay kg	For distance between universal or locking shelves mm
4500	2000
5000	1500
5500	1000

**REQUIRED QUANTITY OF UNIVERSAL OR LOCKING SHELVES PER BAY**

Shelving height mm	Quantity of universal or locking shelves
1000	2
1500	2
2000	2
2200	3
2500	3
3000	3

**1 UPRIGHT FRAMES** ■ 01 ■ 02 ■ 04 ■ 08

ORD. NO.	DIM. mm
*F SR 0510 01 04	53x553x1000 h
*F SR 0516 01 04	53x553x1500 h
F SR 0520 00 04	53x553x2000 h
F SR 0522 00 04	53x553x2200 h
F SR 0525 00 04	53x553x2500 h
F SR 0530 00 04	53x553x3000 h

\*Including cover panels

**2 BACK PANELS** ■ 01 ■ 02

ORD. NO.	DIM. mm
F SR 2020 00 01	1000 h
F SR 2031 00 01	1500 h
F SR 2040 00 01	2000 h
F SR 2050 00 01	2200 h
F SR 2060 00 01	2500 h
F SR 2070 00 01	3000 h

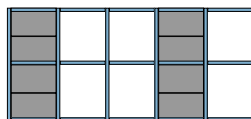

- A back panel must be fitted to each third bay

**3 CROSS BRACINGS** ■ 01 ■ 02

ORD. NO.	For shelving height mm
F SR 7020 00 01	1500 / 2200
F SR 7050 00 01	2500 / 3000



- A cross bracing must be fitted to each third bay

**4 UNIVERSAL SHELVES** ■ 01 ■ 02 ■ 04 ■ 08

ORD. NO.	DIM. mm
F SR 1110 00 04	661x553x46 h

Load capacity: 250 kg

**8 PERFORATED ADJUSTABLE SHELVES** ■ 01 ■ 02 ■ 04 ■ 08

ORD. NO.	DIM. mm
F SR 1310 01 04	661x553x35 h

Load capacity: 300 kg

- This type of shelf can be fitted only if anti-tilt rod is not fitted

**5 TOP LOCKING SHELVES** ■ 01 ■ 02 ■ 04 ■ 08

ORD. NO.	DIM. mm
F SR 1510 00 04	661x553x46 h

Load capacity: 200 kg

LENGTH = 714 mm DEPTH = 553 mm (36x27 Eh)

SHELVING SYSTEM SYSTEM SR 3627

**6 BOTTOM LOCKING SHELVES** ■ 01 ■ 02 ■ 04 ■ 08

ORD. NO.	DIM. mm
<b>F SR 1610 00 04</b>	661x553x46 h
Load capacity: <b>200 kg</b>	

**7 INTERMEDIATE LOCKING SHELVES** ■ 01 ■ 02 ■ 04 ■ 08

ORD. NO.	DIM. mm
<b>F SR 1710 00 04</b>	661x553x46 h
Load capacity: <b>200 kg</b>	

**11 SIDE PANELS** ■ 01 ■ 02 ■ 04 ■ 08

ORD. NO.	DIM. mm
<b>F SR 2405 00 04</b>	23x553x1000 h
<b>F SR 2410 00 04</b>	23x553x1100 h
<b>F SR 2415 00 04</b>	23x553x1250 h
<b>F SR 2425 00 04</b>	23x553x1500 h

**9 LOCKING SET**

ORD. NO.	For shelving depth mm
<b>F SR 8101 00 00</b>	553
Including 1 lock with 2 keys, 1 square rod, 1 anti-tilt rod activation group.	
■ Spare key see page F42	
Spare key (for lock ref. 9)	
ORD. NO. R CSR 0003 00	

**10 ANTI-TILT ROD** ■ 01

ORD. NO.	Rod height mm
<b>F AG 9116 00 01</b>	300
<b>F AG 9124 00 01</b>	500
<b>F AG 9128 00 01</b>	600
<b>F AG 9132 00 01</b>	700
<b>F AG 9133 00 01</b>	725
<b>F AG 9134 00 01</b>	750
<b>F AG 9140 00 01</b>	900
<b>F AG 9146 00 01</b>	1050
<b>F AG 9150 00 01</b>	1150
<b>F AG 9153 00 01</b>	1225
<b>F AG 9160 00 01</b>	1400
<b>F AG 9165 00 01</b>	1525
<b>F AG 9170 00 01</b>	1650
<b>F AG 9180 00 01</b>	1900

■ It is necessary to fit an anti-tilt rod if drawers or extension shelves are installed

**12 LOCKING SYSTEM TOTAL HEIGHT** ■ 01

ORD. NO.	Rod height mm	For frame height ref. 1 mm
<b>F SR 8310 01 01</b>	900+950 h	2000 h
<b>F SR 8330 01 01</b>	900+1150 h	2200 h
<b>F SR 8350 01 01</b>	900+1450 h	2500 h
<b>F SR 8370 01 01</b>	1400+1450 h	3000 h



**C NORMAL EXTENSION SHELVES (PE-S)** ■ 01 ■ 02 ■ 04 ■ 08

ORD. NO.	Usable dim. mm
<b>F FG 8010 00 04</b>	610x459
Side height: -	
Load capacity: <b>100 kg</b>	
Extension: 87%	

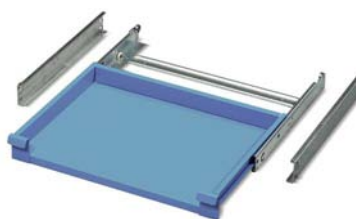

**C TELESCOPIC FULL EXTENSION SHELVES (PE-TT)** ■ 01 ■ 02 ■ 04 ■ 08

ORD. NO.	Usable dim. mm
<b>F FG 8110 00 04</b>	610x459
Side height: -	
Load capacity: <b>200 kg</b>	
Extension: 100%	

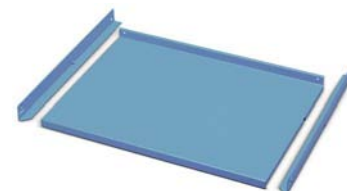

**A ADJUSTABLE SHELVES** ■ 01 ■ 02 ■ 04 ■ 08

ORD. NO.	DIM. mm
<b>F SR 1210 01 04</b>	655x460x25 h
Load capacity: <b>150 kg</b>	
■ This type of shelf can be fitted even if anti-tilt rod is fitted	

**B NORMAL EXTENSION DRAWERS (S)** ■ 01 ■ 02 ■ 04 ■ 08

ORD. NO.	Usable dim. mm	Front height	Load capacity kg	Extension
<b>F FG 1005 00 04</b>	600x447x36 h	50	60	87%
<b>F FG 1007 00 04</b>	600x447x61 h	75	80	87%
<b>F FG 1010 00 04</b>	600x447x86 h	100	100	87%
<b>F FG 1012 00 04</b>	600x447x111 h	125	100	87%



■ Set of partitions see page A80 - A81

**B TELESCOPIC FULL EXTENSION DRAWERS (TT)** ■ 01 ■ 02 ■ 04 ■ 08

ORD. NO.	Usable dim. mm	Front height	Load capacity kg	Extension
<b>F FG 1107 00 04</b>	600x447x54 h	75	200	100%
<b>F FG 1110 00 04</b>	600x447x79 h	100	200	100%
<b>F FG 1112 00 04</b>	600x447x104 h	125	200	100%
<b>F FG 1115 00 04</b>	600x447x129 h	150	200	100%
<b>F FG 1120 00 04</b>	600x447x179 h	200	200	100%
<b>F FG 1125 00 04</b>	600x447x229 h	250	200	100%
<b>F FG 1130 00 04</b>	600x447x279 h	300	200	100%



■ Set of partitions see page A80 - A81

SHELVING SYSTEM SYSTEM SR 3627

**TOOL HOLDERS FRAME**

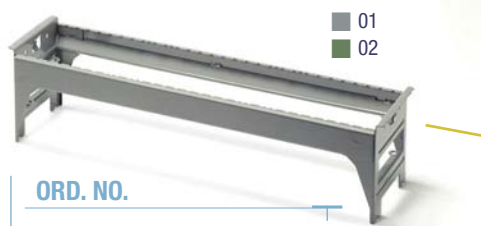

**ORD. NO.**

**F NC 5020 00 01**

Horizontal frame load cap.: 50 kg

Dimensions mm 584x140x146 h



01  
02

**PAIR OF CARRIERS FOR FRAME**

**ORD. NO.**

**F NC 5730 00 01**

For frame ORD. NO. F NC 5020 00 01

Overall dim. mm 442x150 h

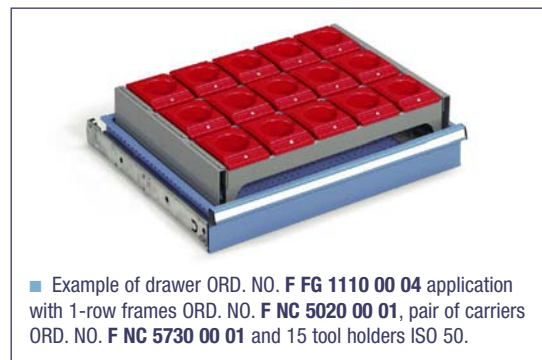

■ Example of drawer ORD. NO. F FG 1110 00 04 application with 1-row frames ORD. NO. F NC 5020 00 01, pair of carriers ORD. NO. F NC 5730 00 01 and 15 tool holders ISO 50.



**PAIR OF GALVANISED HANDLE**

**ORD. NO.**

**F NC 5005 00 99**

For frame ORD. NO. F NC 5020 00 01

**TOOL FOR MULTIPLEX WOODEN INSERT**



**ORD. NO.**

**F NC 5021 00 01**

Horizontal frame load capacity: 50 kg

Overall dimensions mm 584x140x146 h



**ORD. NO.**

**F NC 2510 00 00**

Multiplex wooden insert

Overall dimensions mm 525x138x50 h



Example of tool holder frame ORD. NO. F NC 5021 00 ..

**ALUMINIUM INSERT**



**ORD. NO.**

**F NC 2410 00 00**

Aluminium insert with rubber

OVERALL DIMENSIONS mm

525x135x45 h

**WOODEN INSERT**



**ORD. NO.**

**F NC 2530 00 01**

Wooden insert

OVERALL DIMENSIONS mm

600x450x160 h



Example of tool holder frame ORD. NO. F NC 5020 00 ..



Example of drawer ORD. NO. F FG 1110 00 04 application with wooden insert ORD. NO. F NC 2530 00 00.

LENGTH = 714 mm DEPTH = 553 mm (36x27 Eh)

SHELVING SYSTEM SYSTEM SR 3627

TOOL HOLDER FRAMES 3-ROWS FOR DRAWERS

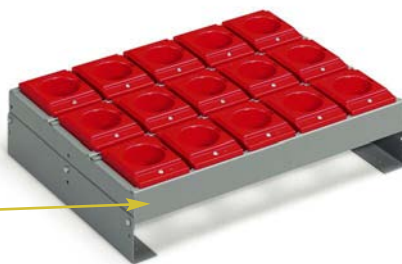

The tool holder frame load capacity is given by the drawer load capacity

ORD. NO.

F NC 5120 00 01

Overall dimension mm 584x444x69 h

PAIR OF CARRIERS

ORD. NO.

DIMENSIONS mm

FOR HEIGHT TAPER mm REF. A

F NC 5630 00 01

446x86 h

A = 93 / 118 / 143

F NC 5830 00 01

446x136 h

A = 143 / 168 / 193

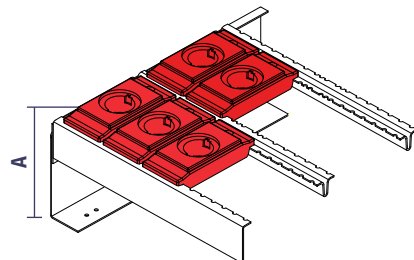

ORD. NO. TOOL HOLDERS

TOOL HOLDER TYPE	MAX QUANTITY PER TOOL FRAME F NC 5020 00 ..	MAX QUANTITY PER TOOL FRAME F NC 5120 00 ..
------------------	---	---

F NC 9510 00 03	ISO 30	7	24
F NC 9530 00 03	ISO 40	7	24
F NC 9540 00 03	ISO 45	5	18
F NC 9550 00 03	ISO 50	5	15
F NC 9560 00 03	VDI 30	7	24
F NC 9570 00 03	VDI 40	5	18
F NC 9580 00 03	VDI 50	5	18
F NC 9590 00 03	VDI 60	5	15
F NC 9720 00 03	MORSE TAPER 2	7	24
F NC 9730 00 03	MORSE TAPER 3	7	24
F NC 9740 00 03	MORSE TAPER 4	7	24
F NC 9750 00 03	MORSE TAPER 5	5	18
F NC 9270 00 03	CAPTO C3	7	24
F NC 9275 00 03	CAPTO C4	5	18
F NC 9280 00 03	CAPTO C5	5	18

ORD. NO. TOOL HOLDERS

TOOL HOLDER TYPE	MAX QUANTITY PER TOOL FRAME F NC 5020 00 ..	MAX QUANTITY PER TOOL FRAME F NC 5120 00 ..
------------------	---	---

F NC 9285 00 03	CAPTO C6	5	18
F NC 9290 00 03	CAPTO C8	4	12
F NC 9210 00 03	HSK A32-B40	7	24
F NC 9220 00 03	HSK A40-B50	7	24
F NC 9230 00 03	HSK A50-B63	5	18
F NC 9240 00 03	HSK A63-B80	5	18
F NC 9250 00 03	HSK A80-B100	4	12
F NC 9260 00 03	HSK A100-B125	4	12
F NC 9640 00 03	2"	5	18
F NC 9650 00 03	2" 1/4	5	15
F NC 9010 00 03	58 mm	9	27
F NC 9020 00 03	65 mm	8	24
F NC 9030 00 03	75 mm	7	21
F NC 9040 00 03	87 mm	6	18
F NC 9050 00 03	105 mm	5	15

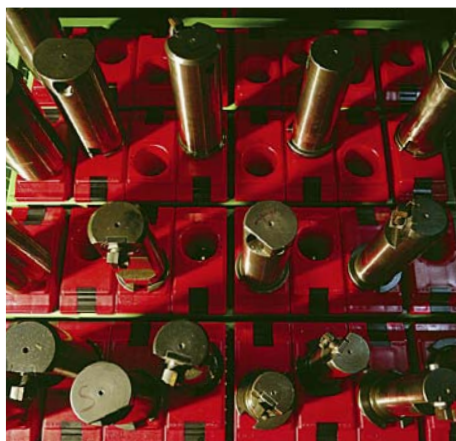



SHELVING SYSTEM SYSTEM SR 5427

LENGTH = 1020 mm DEPTH = 553 mm (54x27 Eh)

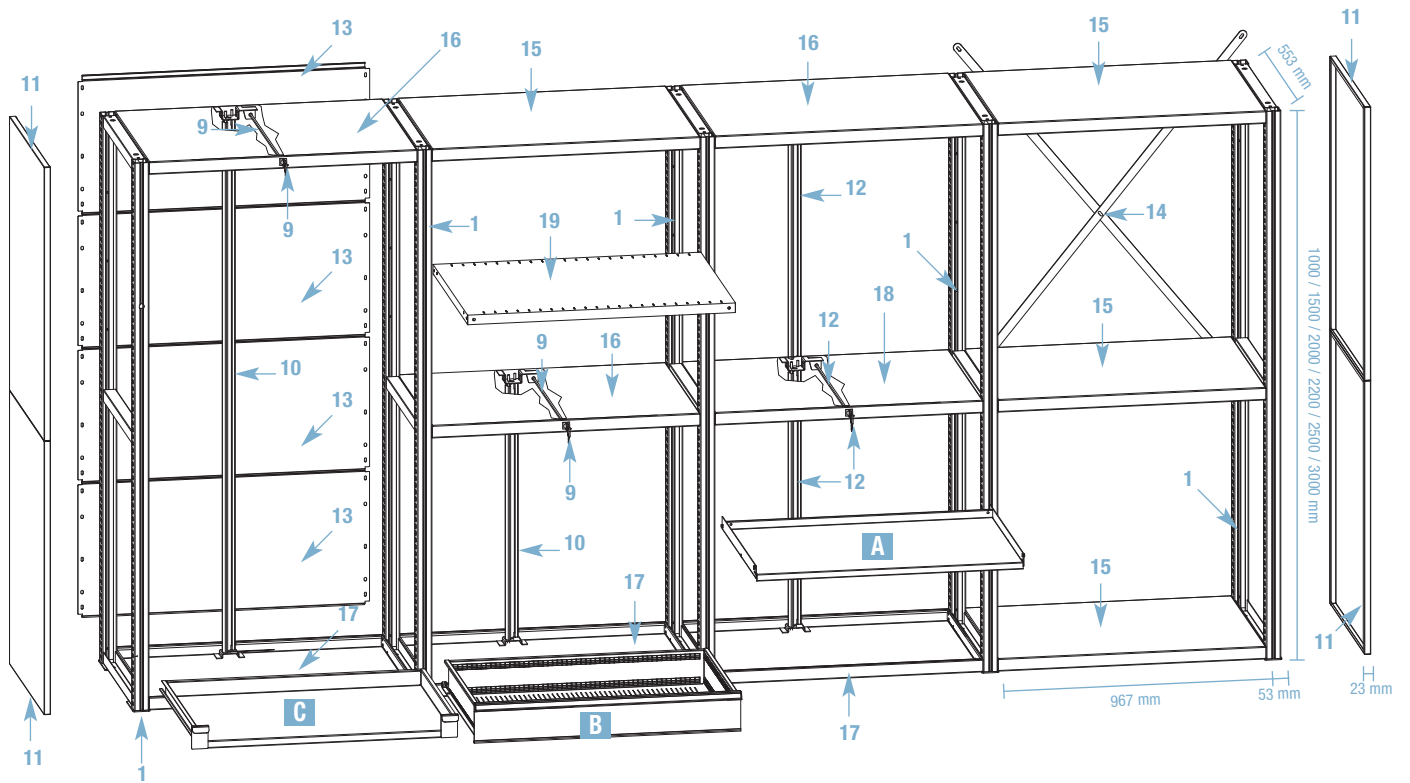

- Accessories see page **F51**
- Roller shutters, doors and safety ladders page **F63 - F65**

**FIXING SET**



Fixing material including (for 1 upright frame) no. 2 steel floor bolts M10x90 mm for uninterrupted concrete floors equal to or higher than class: B25 / RBK250 / MP<sub>A</sub> 25N for mm<sup>2</sup>.

**ORD. NO. F SR 8999 00 99**

- Shelving must be fixed to the wall or floor.

**LOAD CAPACITY PER BAY**

Load capacity per bay kg	For distance between universal or locking shelves mm
<b>4500</b>	2000
<b>5000</b>	1500
<b>5500</b>	1000

**REQUIRED QUANTITY OF UNIVERSAL OR LOCKING SHELVES PER BAY**

Shelving height mm	Quantity of universal or locking shelves
<b>1000</b>	2
<b>1500</b>	2
<b>2000</b>	2
<b>2200</b>	3
<b>2500</b>	3
<b>3000</b>	3

**1 UPRIGHT FRAMES** ■ 01 ■ 02 ■ 04 ■ 08

ORD. NO.	DIM. mm
<b>*F SR 0510 01 04</b>	53x553x1000 h
<b>*F SR 0516 01 04</b>	53x553x1500 h
<b>F SR 0520 00 04</b>	53x553x2000 h
<b>F SR 0522 00 04</b>	53x553x2200 h
<b>F SR 0525 00 04</b>	53x553x2500 h
<b>F SR 0530 00 04</b>	53x553x3000 h

\*Including cover panels

**13 BACK PANELS** ■ 01 ■ 02

ORD. NO.	DIM. mm
<b>F SR 2120 00 01</b>	1000 h
<b>F SR 2131 00 01</b>	1500 h
<b>F SR 2140 00 01</b>	2000 h
<b>F SR 2150 00 01</b>	2200 h
<b>F SR 2160 00 01</b>	2500 h
<b>F SR 2170 00 01</b>	3000 h

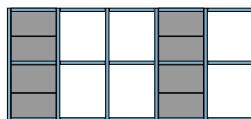

■ A back panel must be fitted to each third bay

**14 CROSS BRACINGS** ■ 01 ■ 02

ORD. NO.	For shelving height mm
<b>F SR 7120 00 01</b>	1500 / 2200
<b>F SR 7150 00 01</b>	2500 / 3000

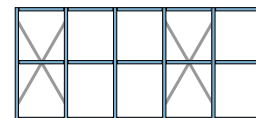

■ A cross bracing must be fitted to each third bay

**15 UNIVERSAL SHELVES** ■ 01 ■ 02 ■ 04 ■ 08

ORD. NO.	DIM. mm
<b>F SR 1120 00 04</b>	967x553x46 h

Load capacity: **250 kg**

**19 PERFORATED ADJUSTABLE SHELVES** ■ 01 ■ 02 ■ 04 ■ 08

ORD. NO.	DIM. mm
<b>F SR 1320 01 04</b>	967x553x35 h

Load capacity: **300 kg**

■ This type of shelf can be fitted only if **anti-tilt rod** is **not** fitted

**16 TOP LOCKING SHELVES** ■ 01 ■ 02 ■ 04 ■ 08

ORD. NO.	DIM. mm
<b>F SR 1520 00 04</b>	967x553x46 h

Load capacity: **200 kg**

LENGTH = 1020 mm DEPTH = 553 mm (54x27 Eh)

SHELVING SYSTEM SYSTEM SR 5427

**17 BOTTOM LOCKING SHELVES** ■ 01 ■ 02 ■ 04 ■ 08

ORD. NO.	DIM. mm
<b>F SR 1620 00 04</b>	967x553x46 h
Load capacity: <b>200 kg</b>	

**18 INTERMEDIATE LOCKING SHELVES** ■ 01 ■ 02 ■ 04 ■ 08

ORD. NO.	DIM. mm
<b>F SR 1720 00 04</b>	967x553x46 h
Load capacity: <b>200 kg</b>	

**11 SIDE PANELS** ■ 01 ■ 02 ■ 04 ■ 08

ORD. NO.	DIM. mm
<b>F SR 2405 00 04</b>	23x553x1000 h
<b>F SR 2410 00 04</b>	23x553x1100 h
<b>F SR 2415 00 04</b>	23x553x1250 h
<b>F SR 2425 00 04</b>	23x553x1500 h

**9 LOCKING SET**

ORD. NO.	For shelving depth mm
<b>F SR 8101 00 00</b>	553
Including 1 lock with 2 keys, 1 square rod, 1 anti-tilt rod activation group.	
■ Spare key see page <b>F42</b>	
Spare key (for lock ref. 9)	
ORD. NO. R CSR 0003 00	

**10 ANTI-TILT ROD** ■ 01

ORD. NO.	Rod height mm
<b>F AG 9116 00 01</b>	300
<b>F AG 9124 00 01</b>	500
<b>F AG 9128 00 01</b>	600
<b>F AG 9132 00 01</b>	700
<b>F AG 9133 00 01</b>	725
<b>F AG 9134 00 01</b>	750
<b>F AG 9140 00 01</b>	900
<b>F AG 9146 00 01</b>	1050
<b>F AG 9150 00 01</b>	1150
<b>F AG 9153 00 01</b>	1225
<b>F AG 9160 00 01</b>	1400
<b>F AG 9165 00 01</b>	1525
<b>F AG 9170 00 01</b>	1650
<b>F AG 9180 00 01</b>	1900

■ It is necessary to fit an anti-tilt rod if drawers or extension shelves are installed

**12 LOCKING SYSTEM TOTAL HEIGHT** ■ 01

ORD. NO.	Rod height mm	For frame height ref. 1 mm
<b>F SR 8310 01 01</b>	900+950 h	2000 h
<b>F SR 8330 01 01</b>	900+1150 h	2200 h
<b>F SR 8350 01 01</b>	900+1450 h	2500 h
<b>F SR 8370 01 01</b>	1400+1450 h	3000 h



**C NORMAL EXTENSION SHELVES (PE-S)** ■ 01 ■ 02 ■ 04 ■ 08

ORD. NO.	Usable dim. mm
<b>F FG 8040 00 04</b>	916x457
Side height: -	
Load capacity: <b>100 kg</b>	
Extension: 87%	

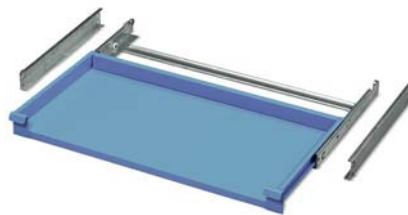

**C TELESCOPIC FULL EXTENSION SHELVES (PE-TT)** ■ 01 ■ 02 ■ 04 ■ 08

ORD. NO.	Usable dim. mm
<b>F FG 8140 00 04</b>	916x457
Side height: -	
Load capacity: <b>150 kg</b>	
Extension: 100%	

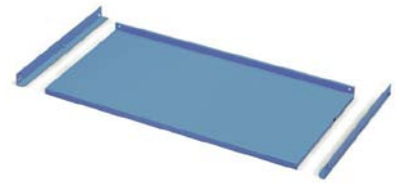

**A ADJUSTABLE SHELVES** ■ 01 ■ 02 ■ 04 ■ 08

ORD. NO.	DIM. mm
<b>F SR 1220 01 04</b>	967x465x25 h
Load capacity: <b>100 kg</b>	
■ This type of shelf can be fitted even if anti-tilt rod is fitted	

**B NORMAL EXTENSION DRAWERS (S)** ■ 01 ■ 02 ■ 04 ■ 08

ORD. NO.	Usable dim. mm	Front height	Load capacity kg	Extension
<b>F FG 4005 00 04</b>	906x447x36 h	50	60	87%
<b>F FG 4007 00 04</b>	906x447x61 h	75	80	87%
<b>F FG 4010 00 04</b>	906x447x86 h	100	100	87%
<b>F FG 4012 00 04</b>	906x447x111 h	125	100	87%

**B TELESCOPIC FULL EXTENSION DRAWERS (TT)** ■ 01 ■ 02 ■ 04 ■ 08

ORD. NO.	Usable dim. mm	Front height	Load capacity kg	Extension
<b>F FG 4107 00 04</b>	906x447x54 h	75	150	100%
<b>F FG 4110 00 04</b>	906x447x79 h	100	150	100%
<b>F FG 4112 00 04</b>	906x447x104 h	125	150	100%
<b>F FG 4115 00 04</b>	906x447x129 h	150	150	100%
<b>F FG 4120 00 04</b>	906x447x179 h	200	150	100%
<b>F FG 4125 00 04</b>	906x447x229 h	250	150	100%
<b>F FG 4130 00 04</b>	906x447x279 h	300	150	100%



■ Set of partitions see page **A113**



■ Set of partitions see page **A113**

SHELVING SYSTEM SYSTEM SR 5427

TOOL HOLDER FRAMES 3-ROWS FOR DRAWERS

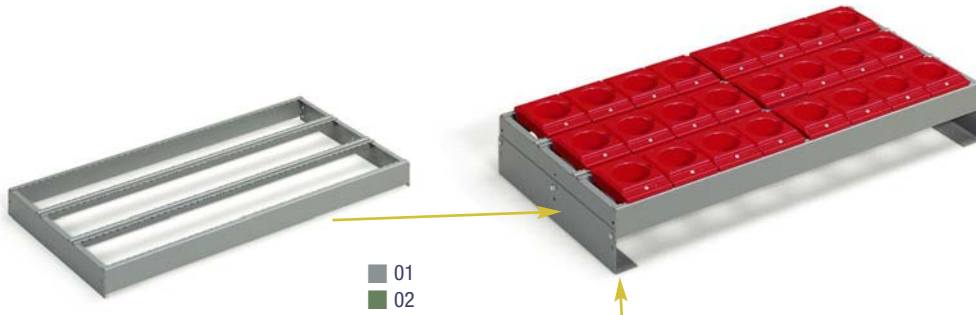

01  
02

ORD. NO.

**F NC 5140 00 01**

Tool holder frames 3-rows

Overall dimensions mm 890x444x69 h

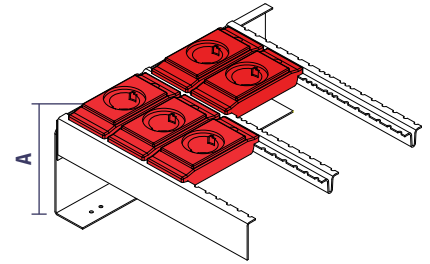

01  
02

■ The tool holder frame load capacity is given by the drawer load capacity



PAIR OF CARRIERS

ORD. NO.

DIMENSIONS mm

FOR HEIGHT TAPER mm REF. A

**F NC 5630 00 01**

446x86 h

A = 93 / 118 / 143

**F NC 5830 00 01**

446x136 h

A = 143 / 168 / 193

ORD. NO. TOOL HOLDERS

TOOL HOLDER TYPE

MAX QUANTITY PER TOOL FRAME F NC 5140 00 ..

<b>F NC 9510 00 03</b>	ISO 30	33
<b>F NC 9530 00 03</b>	ISO 40	33
<b>F NC 9540 00 03</b>	ISO 45	27
<b>F NC 9550 00 03</b>	ISO 50	24
<b>F NC 9560 00 03</b>	VDI 30	33
<b>F NC 9570 00 03</b>	VDI 40	27
<b>F NC 9580 00 03</b>	VDI 50	27
<b>F NC 9590 00 03</b>	VDI 60	24
<b>F NC 9720 00 03</b>	MORSE TAPER 2	33
<b>F NC 9730 00 03</b>	MORSE TAPER 3	33
<b>F NC 9740 00 03</b>	MORSE TAPER 4	33
<b>F NC 9750 00 03</b>	MORSE TAPER 5	27
<b>F NC 9270 00 03</b>	CAPTO C3	33
<b>F NC 9275 00 03</b>	CAPTO C4	27
<b>F NC 9280 00 03</b>	CAPTO C5	27

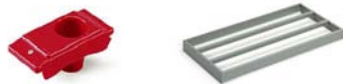

ORD. NO. TOOL HOLDERS

TOOL HOLDER TYPE

MAX QUANTITY PER TOOL FRAME F NC 5140 00 ..

<b>F NC 9285 00 03</b>	CAPTO C6	27
<b>F NC 9290 00 03</b>	CAPTO C8	21
<b>F NC 9210 00 03</b>	HSK A32-B40	33
<b>F NC 9220 00 03</b>	HSK A40-B50	33
<b>F NC 9230 00 03</b>	HSK A50-B63	27
<b>F NC 9240 00 03</b>	HSK A63-B80	27
<b>F NC 9250 00 03</b>	HSK A80-B100	21
<b>F NC 9260 00 03</b>	HSK A100-B125	21
<b>F NC 9640 00 03</b>	2"	27
<b>F NC 9650 00 03</b>	2" 1/4	24
<b>F NC 9010 00 03</b>	58 mm	42
<b>F NC 9020 00 03</b>	65 mm	39
<b>F NC 9030 00 03</b>	75 mm	33
<b>F NC 9040 00 03</b>	87 mm	27
<b>F NC 9050 00 03</b>	105 mm	24

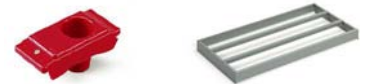

DEPTH = 553 mm (54x27 Eh)

SHELVING SYSTEM SYSTEM SR 0553

COVER PANELS

01 02  
04 08

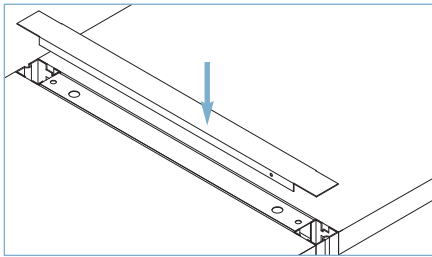

ORD. NO.

**F SR 2510 00 04**

For shelving depth 553 mm

INFIL PANELS

01 02  
04 08

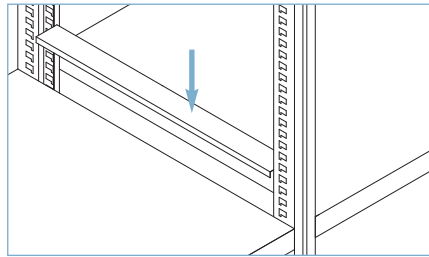

ORD. NO.

**F SR 2710 00 04**

For shelving depth 553 mm

SHELF SIDE PANELS

01 02

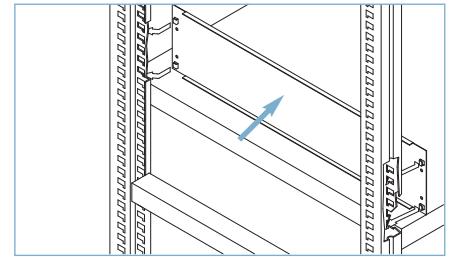

ORD. NO.

HEIGHT mm h

**F SR 2610 00 01**

150

**F SR 2620 00 01**

200

**F SR 2630 00 01**

250

For shelving depth 553 mm

PARTITIONS

01 02

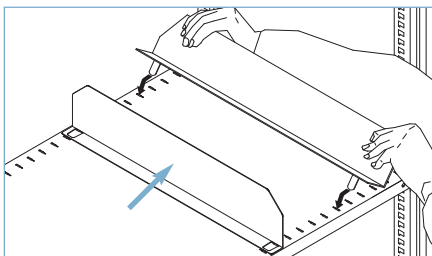

ORD. NO.

HEIGHT mm h

**F SR 2820 00 01**

95

**F SR 2830 00 01**

145

**F SR 2840 00 01**

195

For shelving depth 553 mm

HOOK



ORD. NO.

**F SL 1910 00 99**

Galvanised hook for adjustable shelf

DRAWING POCKETS



ORD. NO.

DIMENSIONS mm

**C MV 15 005**

332x210 h DIN A4

**C MV 15 006**

218x148 h DIN A5

MAGNETIC SUPPORT WITH LABEL



ORD. NO.

**F ST 9997 00 00**

Magnetic support with label and cellophane  
Length 1000 mm

ORD. NO.

**R FST 0007 00**

Spare label and cellophane (100 pcs)

MULTIPLEX WORKTOP

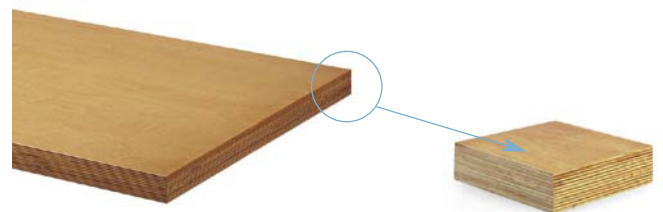

ORD. NO.

DIMENSIONS mm

**F SR 0020 00 00**

967x553x40 h



Using the Multiplex worktop

SHELVING SYSTEM SYSTEM SR 3636

WIDTH = 714 mm DEPTH = 705 mm (36x36 Eh)

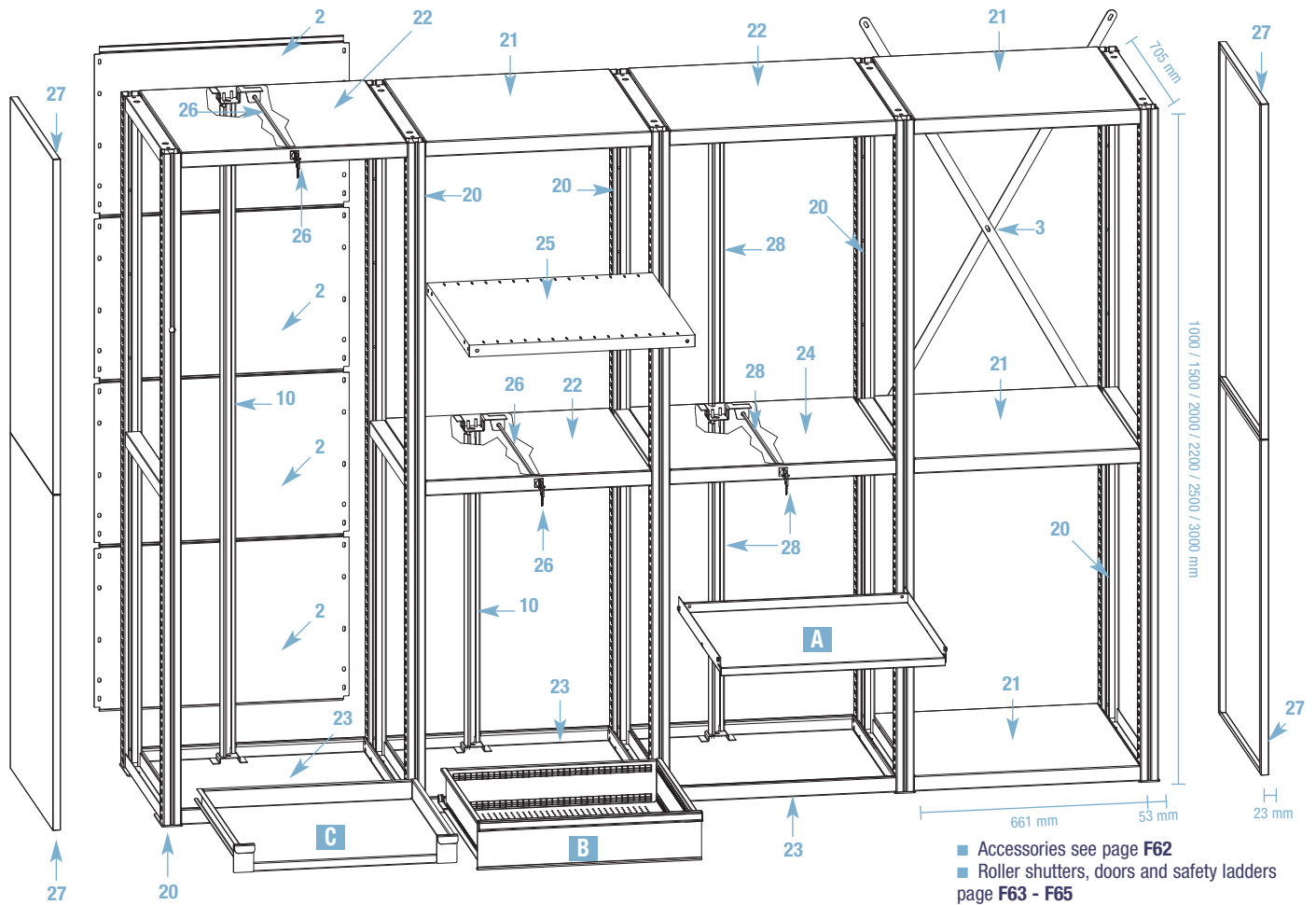

- Accessories see page F62
- Roller shutters, doors and safety ladders page F63 - F65

**FIXING SET**



Fixing material including (for 1 upright frame) no. 2 steel floor bolts M10x90 mm for uninterrupted concrete floors equal to or higher than class: B25 / RBK250 / MP<sub>A</sub> 25N for mm<sup>2</sup>.

ORD. NO. F SR 8999 00 99

- Shelving must be fixed to the wall or floor.

**LOAD CAPACITY PER BAY**

Load capacity per bay kg	For distance between universal or locking shelves mm
4500	2000
5000	1500
5500	1000

**REQUIRED QUANTITY OF UNIVERSAL OR LOCKING SHELVES PER BAY**

Shelving height mm	Quantity of universal or locking shelves
1000	2
1500	2
2000	2
2200	3
2500	3
3000	3

**20 UPRIGHT FRAMES** ■ 01 ■ 02 ■ 04 ■ 08

ORD. NO.	DIM. mm
*F SR 0710 01 04	53x705x1000 h
*F SR 0716 01 04	53x705x1500 h
F SR 0720 00 04	53x705x2000 h
F SR 0722 00 04	53x705x2200 h
F SR 0725 00 04	53x705x2500 h
F SR 0730 00 04	53x705x3000 h

\*Including cover panels

**2 BACK PANELS** ■ 01 ■ 02

ORD. NO.	DIM. mm
F SR 2020 00 01	1000 h
F SR 2031 00 01	1500 h
F SR 2040 00 01	2000 h
F SR 2050 00 01	2200 h
F SR 2060 00 01	2500 h
F SR 2070 00 01	3000 h

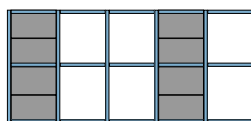

■ A back panel must be fitted to each third bay

**3 CROSS BRACINGS** ■ 01 ■ 02

ORD. NO.	For shelving height mm
F SR 7020 00 01	1500 / 2200
F SR 7050 00 01	2500 / 3000

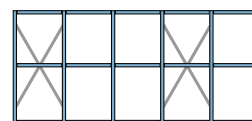

■ A cross bracing must be fitted to each third bay

**21 UNIVERSAL SHELVES** ■ 01 ■ 02 ■ 04 ■ 08

ORD. NO.	DIM. mm
F SR 1160 00 04	661x705x46 h

Load capacity: 250 kg

**25 PERFORATED ADJUSTABLE SHELVES** ■ 01 ■ 02 ■ 04 ■ 08

ORD. NO.	DIM. mm
F SR 1360 01 04	661x705x35 h

Load capacity: 300 kg

■ This type of shelf can be fitted only if anti-tilt rod is not fitted

**22 TOP LOCKING SHELVES** ■ 01 ■ 02 ■ 04 ■ 08

ORD. NO.	DIM. mm
F SR 1560 00 04	661x705x46 h

Load capacity: 200 kg

WIDTH = 714 mm DEPTH = 705 mm (36x36 Eh)

SHELVING SYSTEM SYSTEM SR 3636

**23 BOTTOM LOCKING SHELVES** ■ 01 ■ 02 ■ 04 ■ 08

ORD. NO.	DIM. mm
F SR 1660 00 04	661x705x46 h
Load capacity: 200 kg	

**24 INTERMEDIATE LOCKING SHELVES** ■ 01 ■ 02 ■ 04 ■ 08

ORD. NO.	DIM. mm
F SR 1760 00 04	661x705x46 h
Load capacity: 200 kg	

**27 SIDE PANELS** ■ 01 ■ 02 ■ 04 ■ 08

ORD. NO.	DIM. mm
F SR 2455 00 04	23x705x1000 h
F SR 2460 00 04	23x705x1100 h
F SR 2465 00 04	23x705x1250 h
F SR 2475 00 04	23x705x1500 h

**26 LOCKING SET**

ORD. NO.	For shelving depth mm
F SR 8102 00 00	705
Including 1 lock with 2 keys, 1 square rod, 1 anti-tilt rod activation group.	
■ Spare key see page F42	
Spare key (for lock ref. 26)	
ORD. NO. R CSR 0003 00	

**28 LOCKING SYSTEM TOTAL HEIGHT** ■ 01

ORD. NO.	Rod height mm	For frame height ref. 1 mm
F SR 8310 51 01	900+950 h	2000 h
F SR 8330 51 01	900+1150 h	2200 h
F SR 8350 51 01	900+1450 h	2500 h
F SR 8370 51 01	1400+1450 h	3000 h

**10 ANTI-TILT ROD** ■ 01

ORD. NO.	Rod height mm
F AG 9116 00 01	300
F AG 9124 00 01	500
F AG 9128 00 01	600
F AG 9132 00 01	700
F AG 9133 00 01	725
F AG 9134 00 01	750
F AG 9140 00 01	900
F AG 9146 00 01	1050
F AG 9150 00 01	1150
F AG 9153 00 01	1225
F AG 9160 00 01	1400
F AG 9165 00 01	1525
F AG 9170 00 01	1650
F AG 9180 00 01	1900

■ It is necessary to fit an anti-tilt rod if drawers or extension shelves are installed

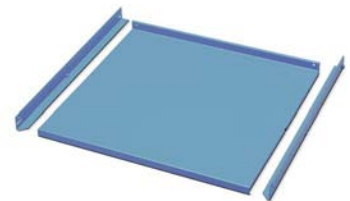
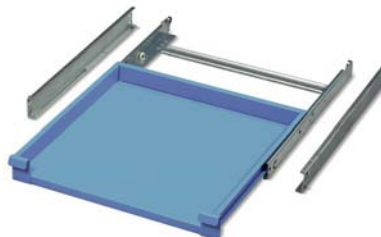
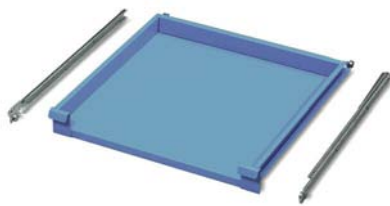

**C NORMAL EXTENSION SHELVES (PE-S)** ■ 01 ■ 02 ■ 04 ■ 08

ORD. NO.	Usable dim. mm
F FG 8020 00 04	610x610
Side height: -	
Load capacity: 100 kg	
Extension: 87%	

**C TELESCOPIC FULL EXTENSION SHELVES (PE-TT)** ■ 01 ■ 02 ■ 04 ■ 08

ORD. NO.	Usable dim. mm
F FG 8120 00 04	610x610
Side height: -	
Load capacity: 200 kg	
Extension: 100%	

**A ADJUSTABLE SHELVES** ■ 01 ■ 02 ■ 04 ■ 08

ORD. NO.	DIM. mm
F SR 1260 01 04	618x618x25 h
Load capacity: 150 kg	

■ This type of shelf can be fitted even if anti-tilt rod is fitted

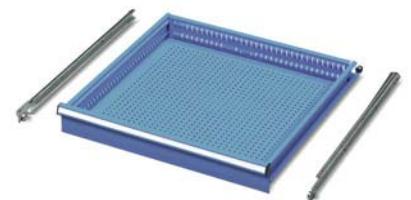

■ Set of partitions see page A96 - A97

**B NORMAL EXTENSION DRAWERS (S)** ■ 01 ■ 02 ■ 04 ■ 08

ORD. NO.	Usable dim. mm	Front height	Load capacity kg	Extension
F FG 2005 00 04	600x600x36 h	50	60	87%
F FG 2007 00 04	600x600x61 h	75	80	87%
F FG 2010 00 04	600x600x86 h	100	100	87%
F FG 2012 00 04	600x600x111 h	125	100	87%
F FG 2015 00 04	600x600x136 h	150	100	87%
F FG 2017 00 04	600x600x161 h	175	100	87%
F FG 2020 00 04	600x600x186 h	200	100	87%
F FG 2030 00 04	600x600x286 h	300	100	87%

**B TELESCOPIC FULL EXTENSION DRAWERS (TT)** ■ 01 ■ 02 ■ 04 ■ 08

ORD. NO.	Usable dim. mm	Front height	Load capacity kg	Extension
F FG 2107 00 04	600x600x54 h	75	200	100%
F FG 2110 00 04	600x600x79 h	100	200	100%
F FG 2112 00 04	600x600x104 h	125	200	100%
F FG 2115 00 04	600x600x129 h	150	200	100%
F FG 2117 00 04	600x600x154 h	175	200	100%
F FG 2120 00 04	600x600x179 h	200	200	100%
F FG 2125 00 04	600x600x229 h	250	200	100%
F FG 2130 00 04	600x600x279 h	300	200	100%
F FG 2140 00 04	600x600x379 h	400	200	100%



■ Set of partitions see page A96 - A97

SHELVING SYSTEM SYSTEM SR 3636

**TOOL HOLDERS FRAME**

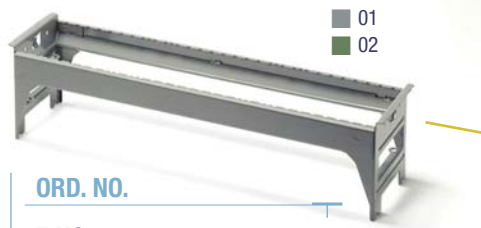

**ORD. NO.**

**F NC 5020 00 01**

Horizontal frame load cap.: 50 kg  
Dimensions mm 584x140x146 h



01  
02

**PAIR OF CARRIERS**

**ORD. NO.**

**F NC 5750 00 01**

For frame ORD. NO. F NC 5020 00 01  
Overall dimensions mm 592x150 h



■ Example of drawer ORD. NO. F FG 2110 00 04 application with 1-row frames ORD. NO. F NC 5020 00 01, pair of carriers ORD. NO. F NC 5750 00 01 and 20 tool holders ISO 50.



**PAIR OF GALVANISED HANDLE**

**ORD. NO.**

**F NC 5005 00 99**

For frame ORD. NO. F NC 5020 00 01

**TOOL FOR MULTIPLEX WOODEN INSERT**



**ORD. NO.**

**F NC 5021 00 01**

Horizontal frame load capacity: 50 kg  
Overall dimensions mm 584x140x146 h



**ORD. NO.**

**F NC 2510 00 00**

Multiplex wooden insert  
Overall dimensions mm 525x138x50 h



Example of tool holder frame  
ORD. NO. F NC 5021 00 ..

**ALUMINIUM INSERT**



**ORD. NO.**

**F NC 2410 00 00**

Aluminium insert with rubber

OVERALL DIMENSIONS mm

525x135x45 h



Example of tool holder frame  
ORD. NO. F NC 5020 00 ..

**WOODEN INSERT**



**ORD. NO.**

**F NC 2550 00 01**

Wooden insert

OVERALL DIMENSIONS mm

600x600x160 h



Example of drawer ORD. NO. F FG 2110 00 04 application with wooden insert ORD. NO. F NC 2550 00 00.

WIDTH = 714 mm DEPTH = 705 mm (36x36 Eh)

SHELVING SYSTEM SYSTEM SR 3636

TOOL HOLDER FRAMES 4-ROWS FOR DRAWERS

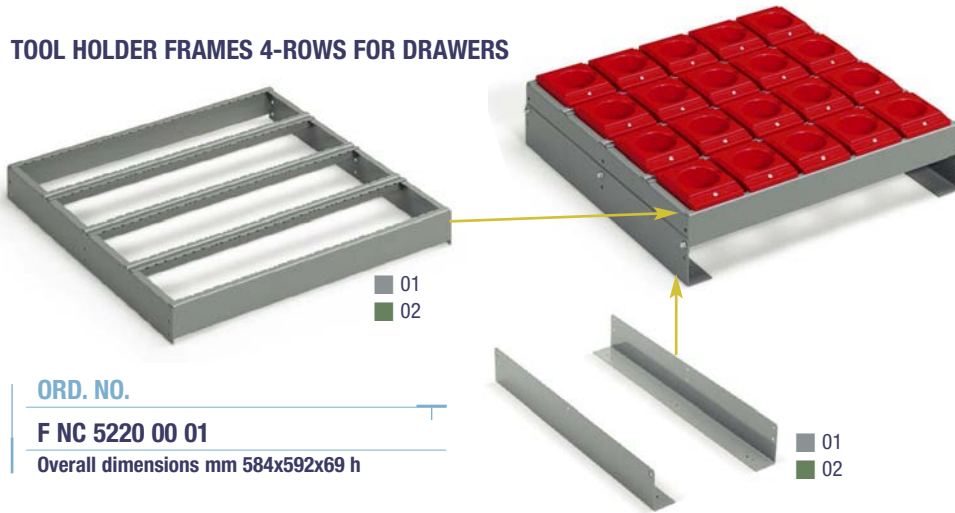

■ The tool holder frame load capacity is given by the drawer load capacity

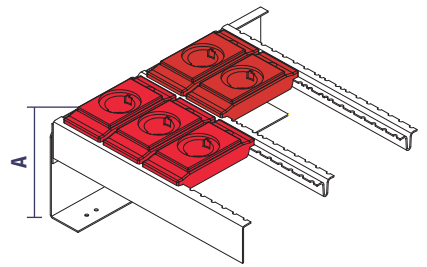

ORD. NO.

F NC 5220 00 01

Overall dimensions mm 584x592x69 h

PAIR OF CARRIERS

ORD. NO.

DIMENSIONS mm

FOR HEIGHT TAPER mm REF. A

F NC 5650 00 01

594X86 h

A = 93 / 118 / 143

F NC 5840 00 01

594X136 h

A = 143 / 168 / 193



ORD. NO. TOOL HOLDERS

TOOL HOLDER TYPE	MAX QUANTITY PER TOOL FRAME F NC 5020 00 ..	MAX QUANTITY PER TOOL FRAME F NC 5220 00 ..
------------------	---	---

F NC 9510 00 03	ISO 30	7	32
F NC 9530 00 03	ISO 40	7	32
F NC 9540 00 03	ISO 45	5	24
F NC 9550 00 03	ISO 50	5	20
F NC 9560 00 03	VDI 30	7	32
F NC 9570 00 03	VDI 40	5	24
F NC 9580 00 03	VDI 50	5	24
F NC 9590 00 03	VDI 60	5	20
F NC 9720 00 03	MORSE TAPER 2	7	32
F NC 9730 00 03	MORSE TAPER 3	7	32
F NC 9740 00 03	MORSE TAPER 4	7	32
F NC 9750 00 03	MORSE TAPER 5	5	24
F NC 9270 00 03	CAPTO C3	7	32
F NC 9275 00 03	CAPTO C4	5	24
F NC 9280 00 03	CAPTO C5	5	24



ORD. NO. TOOL HOLDERS

TOOL HOLDER TYPE	MAX QUANTITY PER TOOL FRAME F NC 5020 00 ..	MAX QUANTITY PER TOOL FRAME F NC 5220 00 ..
------------------	---	---

F NC 9285 00 03	CAPTO C6	5	24
F NC 9290 00 03	CAPTO C8	4	16
F NC 9210 00 03	HSK A32-B40	7	32
F NC 9220 00 03	HSK A40-B50	7	32
F NC 9230 00 03	HSK A50-B63	5	24
F NC 9240 00 03	HSK A63-B80	5	24
F NC 9250 00 03	HSK A80-B100	4	16
F NC 9260 00 03	HSK A100-B125	4	16
F NC 9640 00 03	2"	5	24
F NC 9650 00 03	2" 1/4	5	20
F NC 9010 00 03	58 mm	9	36
F NC 9020 00 03	65 mm	8	32
F NC 9030 00 03	75 mm	7	28
F NC 9040 00 03	87 mm	6	24
F NC 9050 00 03	105 mm	5	20





SHELVING SYSTEM SYSTEM SR 5436

WIDTH = 1020 mm DEPTH = 705 mm (54x36 Eh)

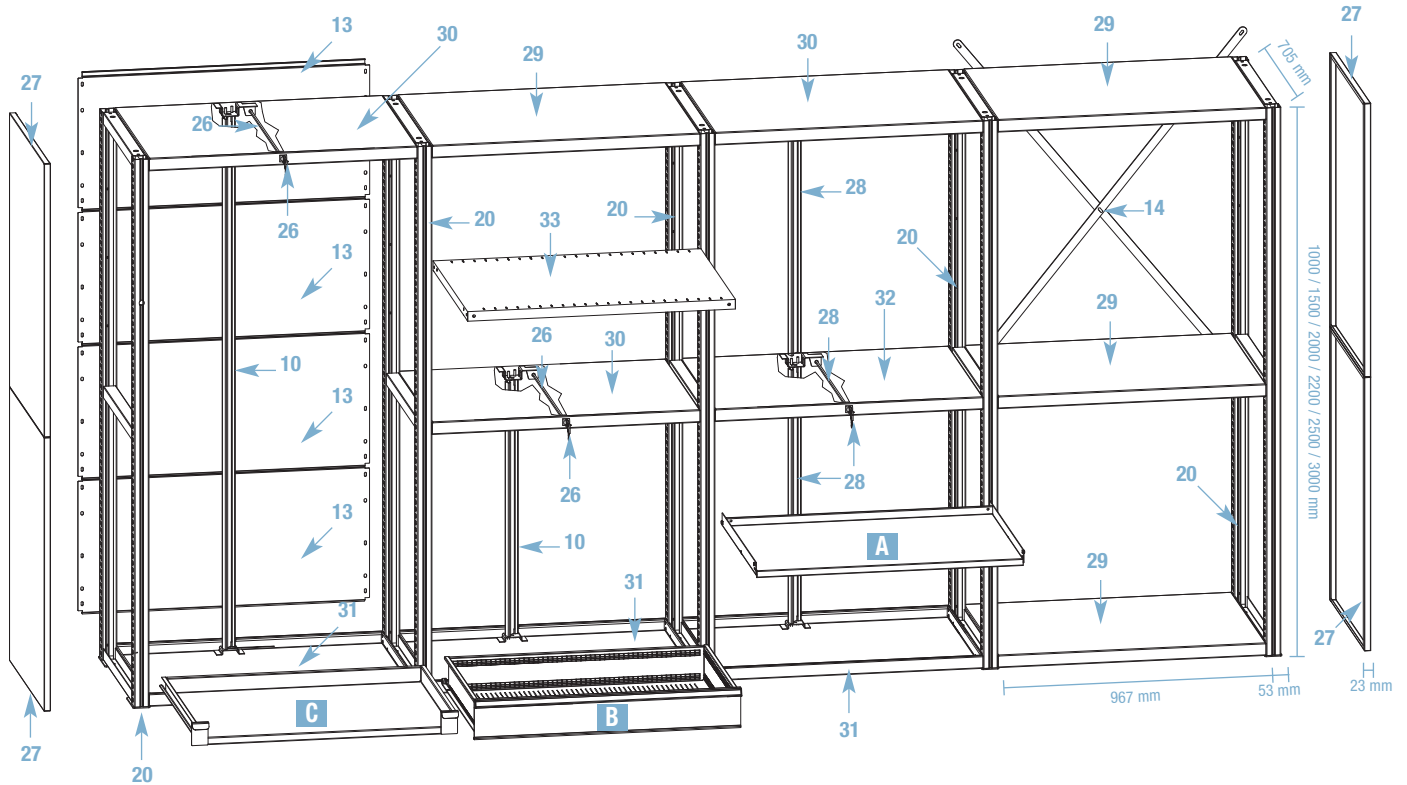

■ Accessories see page F62  
 ■ Roller shutters, doors and safety ladders page F63 - F65

**FIXING SET**



Fixing material including (for 1 upright frame) no. 2 steel floor bolts M10x90 mm for uninterrupted concrete floors equal to or higher than class: B25 / RBK250 / MP<sub>A</sub> 25N for mm<sup>2</sup>.

ORD. NO. F SR 8999 00 99

■ Shelving must be fixed to the wall or floor.

**LOAD CAPACITY PER BAY**

Load capacity per bay kg	For distance between universal or locking shelves mm
4500	2000
5000	1500
5500	1000

**REQUIRED QUANTITY OF UNIVERSAL OR LOCKING SHELVES PER BAY**

Shelving height mm	Quantity of universal or locking shelves
1000	2
1500	2
2000	2
2200	3
2500	3
3000	3

**20 UPRIGHT FRAMES** ■ 01 ■ 02 ■ 04 ■ 08

ORD. NO.	DIM. mm
*F SR 0710 01 04	53x705x1000 h
*F SR 0716 01 04	53x705x1500 h
F SR 0720 00 04	53x705x2000 h
F SR 0722 00 04	53x705x2200 h
F SR 0725 00 04	53x705x2500 h
F SR 0730 00 04	53x705x3000 h

\*Including cover panels

**13 BACK PANELS** ■ 01 ■ 02

ORD. NO.	DIM. mm
F SR 2120 00 01	1000 h
F SR 2131 00 01	1500 h
F SR 2140 00 01	2000 h
F SR 2150 00 01	2200 h
F SR 2160 00 01	2500 h
F SR 2170 00 01	3000 h

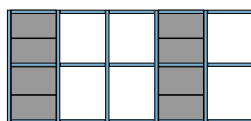

■ A back panel must be fitted to each third bay

**14 CROSS BRACINGS** ■ 01 ■ 02

ORD. NO.	For shelving height mm
F SR 7120 00 01	1500 / 2200
F SR 7150 00 01	2500 / 3000

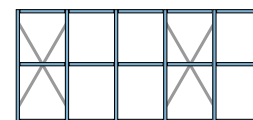

■ A cross bracing must be fitted to each third bay

**29 UNIVERSAL SHELVES** ■ 01 ■ 02 ■ 04 ■ 08

ORD. NO.	DIM. mm
F SR 1170 00 04	967x705x46 h

Load capacity: 250 kg

**33 PERFORATED ADJUSTABLE SHELVES** ■ 01 ■ 02 ■ 04 ■ 08

ORD. NO.	DIM. mm
F SR 1370 01 04	967x705x35 h

Load capacity: 250 kg

■ This type of shelf can be fitted only if anti-tilt rod is not fitted

**30 TOP LOCKING SHELVES** ■ 01 ■ 02 ■ 04 ■ 08

ORD. NO.	DIM. mm
F SR 1570 00 04	967x705x46 h

Load capacity: 200 kg

WIDTH = 1020 mm DEPTH = 705 mm (54x36 Eh)

SHELVING SYSTEM SYSTEM SR 5436

**31 BOTTOM LOCKING SHELVES** ■ 01 ■ 02 ■ 04 ■ 08

ORD. NO.	DIM. mm
F SR 1670 00 04	967x705x46 h
Load capacity: 200 kg	

**32 INTERMEDIATE LOCKING SHELVES** ■ 01 ■ 02 ■ 04 ■ 08

ORD. NO.	DIM. mm
F SR 1770 00 04	967x705x46 h
Load capacity: 200 kg	

**27 SIDE PANELS** ■ 01 ■ 02 ■ 04 ■ 08

ORD. NO.	DIM. mm
F SR 2455 00 04	23x705x1000 h
F SR 2460 00 04	23x705x1100 h
F SR 2465 00 04	23x705x1250 h
F SR 2475 00 04	23x705x1500 h

**26 LOCKING SET**

ORD. NO.	For shelving depth mm
F SR 8102 00 00	705
Including 1 lock with 2 keys, 1 square rod, 1 anti-tilt rod activation group.	
■ Spare key see page F42	
Spare key (for lock ref. 26)	
ORD. NO. R CSR 0003 00	

**28 LOCKING SYSTEM TOTAL HEIGHT** ■ 01

ORD. NO.	Rod height mm	For frame height ref. 1 mm
F SR 8310 51 01	900+950 h	2000 h
F SR 8330 51 01	900+1150 h	2200 h
F SR 8350 51 01	900+1450 h	2500 h
F SR 8370 51 01	1400+1450 h	3000 h

**10 ANTI-TILT ROD** ■ 01

ORD. NO.	Rod height mm
F AG 9116 00 01	300
F AG 9124 00 01	500
F AG 9128 00 01	600
F AG 9132 00 01	700
F AG 9133 00 01	725
F AG 9134 00 01	750
F AG 9140 00 01	900
F AG 9146 00 01	1050
F AG 9150 00 01	1150
F AG 9153 00 01	1225
F AG 9160 00 01	1400
F AG 9165 00 01	1525
F AG 9170 00 01	1650
F AG 9180 00 01	1900

■ It is necessary to fit an anti-tilt rod if drawers or extension shelves are installed



**C NORMAL EXTENSION SHELVES (PE-S)** ■ 01 ■ 02 ■ 04 ■ 08

ORD. NO.	Usable dim. mm
F FG 8050 00 04	916x610
Side height: -	
Load capacity: 100 kg	
Extension: 87%	

**C TELESCOPIC FULL EXTENSION SHELVES (PE-TT)** ■ 01 ■ 02 ■ 04 ■ 08

ORD. NO.	Usable dim. mm
F FG 8150 00 04	916x610
Side height: -	
Load capacity: 150 kg	
Extension: 100%	

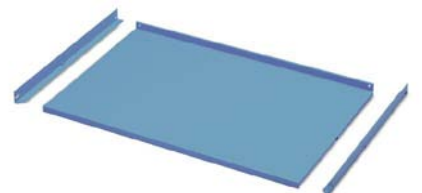

**A ADJUSTABLE SHELVES** ■ 01 ■ 02 ■ 04 ■ 08

ORD. NO.	DIM. mm
F SR 1270 01 04	967x618x25 h
Load capacity: 100 kg	
■ This type of shelf can be fitted even if anti-tilt rod is fitted	

**B NORMAL EXTENSION DRAWERS (S)** ■ 01 ■ 02 ■ 04 ■ 08

ORD. NO.	Usable dim. mm	Front height	Load capacity kg	Extension
F FG 5005 00 04	906x600x36 h	50	60	87%
F FG 5007 00 04	906x600x61 h	75	80	87%
F FG 5010 00 04	906x600x86 h	100	100	87%
F FG 5012 00 04	906x600x111 h	125	100	87%

**B TELESCOPIC FULL EXTENSION DRAWERS (TT)** ■ 01 ■ 02 ■ 04 ■ 08

ORD. NO.	Usable dim. mm	Front height	Load capacity kg	Extension
F FG 5107 00 04	906x600x54 h	75	150	100%
F FG 5110 00 04	906x600x79 h	100	150	100%
F FG 5112 00 04	906x600x104 h	125	150	100%
F FG 5115 00 04	906x600x129 h	150	150	100%
F FG 5117 00 04	906x600x154 h	175	150	100%
F FG 5120 00 04	906x600x179 h	200	150	100%
F FG 5125 00 04	906x600x229 h	250	150	100%
F FG 5130 00 04	906x600x279 h	300	150	100%



■ Set of partitions see page A121



■ Set of partitions see page A121

SHELVING SYSTEM SYSTEM SR 6436

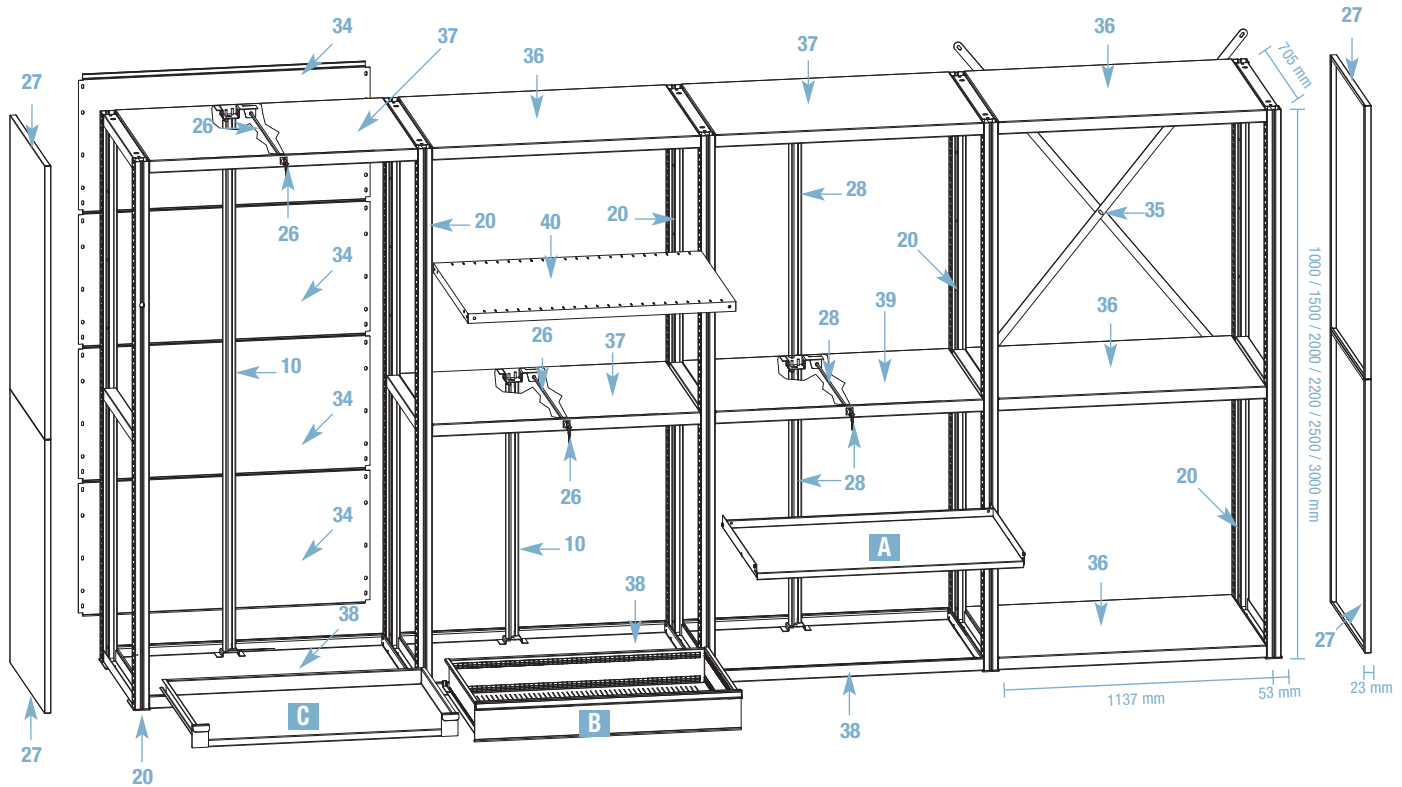

■ Accessories see page **F62**  
 ■ Roller shutters, doors and safety ladders page **F63 - F65**

**FIXING SET**



Fixing material including (for 1 upright frame) no. 2 steel floor bolts M10x90 mm for uninterrupted concrete floors equal to or higher than class: B25 / RBK250 / MP<sub>A</sub> 25N for mm<sup>2</sup>.

**ORD. NO. F SR 8999 00 99**

■ Shelving must be fixed to the wall or floor.

**LOAD CAPACITY PER BAY**

Load capacity per bay kg	For distance between universal or locking shelves mm
<b>4500</b>	2000
<b>5000</b>	1500
<b>5500</b>	1000

**REQUIRED QUANTITY OF UNIVERSAL OR LOCKING SHELVES PER BAY**

Shelving height mm	Quantity of universal or locking shelves
<b>1000</b>	2
<b>1500</b>	2
<b>2000</b>	2
<b>2200</b>	3
<b>2500</b>	3
<b>3000</b>	3

**20 UPRIGHT FRAMES** ■ 01 ■ 02 ■ 04 ■ 08

ORD. NO.	DIM. mm
<b>*F SR 0710 01 04</b>	53x705x1000 h
<b>*F SR 0716 01 04</b>	53x705x1500 h
<b>F SR 0720 00 04</b>	53x705x2000 h
<b>F SR 0722 00 04</b>	53x705x2200 h
<b>F SR 0725 00 04</b>	53x705x2500 h
<b>F SR 0730 00 04</b>	53x705x3000 h

\*Including cover panels

**34 BACK PANELS** ■ 01 ■ 02

ORD. NO.	DIM. mm
<b>F SR 2220 00 01</b>	1000 h
<b>F SR 2231 00 01</b>	1500 h
<b>F SR 2240 00 01</b>	2000 h
<b>F SR 2250 00 01</b>	2200 h
<b>F SR 2260 00 01</b>	2500 h
<b>F SR 2270 00 01</b>	3000 h

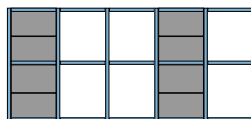

■ A back panel must be fitted to each third bay

**35 CROSS BRACINGS** ■ 01 ■ 02

ORD. NO.	For shelving height mm
<b>F SR 7220 00 01</b>	1500 / 2200
<b>F SR 7250 00 01</b>	2500 / 3000

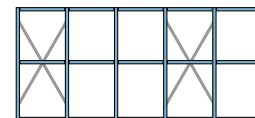

■ A cross bracing must be fitted to each third bay

**36 UNIVERSAL SHELVES** ■ 01 ■ 02 ■ 04 ■ 08

ORD. NO.	DIM. mm
<b>F SR 1180 00 04</b>	1137x705x46 h

Load capacity: **250 kg**

**40 PERFORATED ADJUSTABLE SHELVES** ■ 01 ■ 02 ■ 04 ■ 08

ORD. NO.	DIM. mm
<b>F SR 1380 01 04</b>	1137x705x35 h

Load capacity: **300 kg**

■ This type of shelf can be fitted only if **anti-tilt rod** is **not** fitted

**37 TOP LOCKING SHELVES** ■ 01 ■ 02 ■ 04 ■ 08

ORD. NO.	DIM. mm
<b>F SR 1580 00 04</b>	1137x705x46 h

Load capacity: **200 kg**

WIDTH = 1190 mm DEPTH = 705 mm (64x36 Eh)

SHELVING SYSTEM SYSTEM SR 6436

**38** BOTTOM LOCKING SHELVES

■ 01 ■ 02  
■ 04 ■ 08

ORD. NO.	DIM. mm
<b>F SR 1680 00 04</b>	1137x705x46 h
Load capacity: <b>200 kg</b>	

**39** INTERMEDIATE LOCKING SHELVES

■ 01 ■ 02  
■ 04 ■ 08

ORD. NO.	DIM. mm
<b>F SR 1780 00 04</b>	1137x705x46 h
Load capacity: <b>200 kg</b>	

**27** SIDE PANELS

■ 01 ■ 02  
■ 04 ■ 08

ORD. NO.	DIM. mm
<b>F SR 2455 00 04</b>	23x705x1000 h
<b>F SR 2460 00 04</b>	23x705x1100 h
<b>F SR 2465 00 04</b>	23x705x1250 h
<b>F SR 2475 00 04</b>	23x705x1500 h

**26** LOCKING SET

ORD. NO.	For shelving depth mm
<b>F SR 8102 00 00</b>	705

Including 1 lock with 2 keys, 1 square rod, 1 anti-tilt rod activation group.

■ Spare key see page **F42**

**Spare key** (for lock ref. 26)

**ORD. NO. R CSR 0003 00**

**28** LOCKING SYSTEM TOTAL HEIGHT ■ 01

ORD. NO.	Rod height mm	For frame height ref. 1 mm
<b>F SR 8310 51 01</b>	900+950 h	2000 h
<b>F SR 8330 51 01</b>	900+1150 h	2200 h
<b>F SR 8350 51 01</b>	900+1450 h	2500 h
<b>F SR 8370 51 01</b>	1400+1450 h	3000 h

**10** ANTI-TILT ROD ■ 01

ORD. NO.	Rod height mm
<b>F AG 9116 00 01</b>	300
<b>F AG 9124 00 01</b>	500
<b>F AG 9128 00 01</b>	600
<b>F AG 9132 00 01</b>	700
<b>F AG 9133 00 01</b>	725
<b>F AG 9134 00 01</b>	750
<b>F AG 9140 00 01</b>	900
<b>F AG 9146 00 01</b>	1050
<b>F AG 9150 00 01</b>	1150
<b>F AG 9153 00 01</b>	1225
<b>F AG 9160 00 01</b>	1400
<b>F AG 9165 00 01</b>	1525
<b>F AG 9170 00 01</b>	1650
<b>F AG 9180 00 01</b>	1900

■ It is necessary to fit an anti-tilt rod if drawers or extension shelves are installed



**C** TELESCOPIC FULL EXTENSION SHELVES (PE-TT)

■ 01 ■ 02  
■ 04 ■ 08

ORD. NO.	Usable dim. mm
<b>F FG 8160 00 04</b>	1086x610
Side height: -	
Load capacity: <b>150 kg</b>	
Extension: 100%	

**A** ADJUSTABLE SHELVES

■ 01 ■ 02  
■ 04 ■ 08

ORD. NO.	DIM. mm
<b>F SR 1280 01 04</b>	1137x618x35 h
Load capacity: <b>150 kg</b>	
■ This type of shelf can be fitted even if <b>anti-tilt rod</b> is fitted	

**B** TELESCOPIC FULL EXTENSION DRAWERS (TT)

■ 01 ■ 02 ■ 04 ■ 08

ORD. NO.	Usable dim. mm	Front height	Load capacity kg	Extension
<b>F FG 6107 00 04</b>	1076x600x54 h	75	150	100%
<b>F FG 6110 00 04</b>	1076x600x79 h	100	150	100%
<b>F FG 6112 00 04</b>	1076x600x104 h	125	150	100%
<b>F FG 6115 00 04</b>	1076x600x129 h	150	150	100%
<b>F FG 6120 00 04</b>	1076x600x179 h	200	150	100%
<b>F FG 6125 00 04</b>	1076x600x229 h	250	150	100%
<b>F FG 6130 00 04</b>	1076x600x279 h	300	150	100%



■ Set of partitions see page **A129**

SHELVING SYSTEM SYSTEM SR 7836

WIDTH = 1428 mm DEPTH = 705 mm (78x36 Eh)

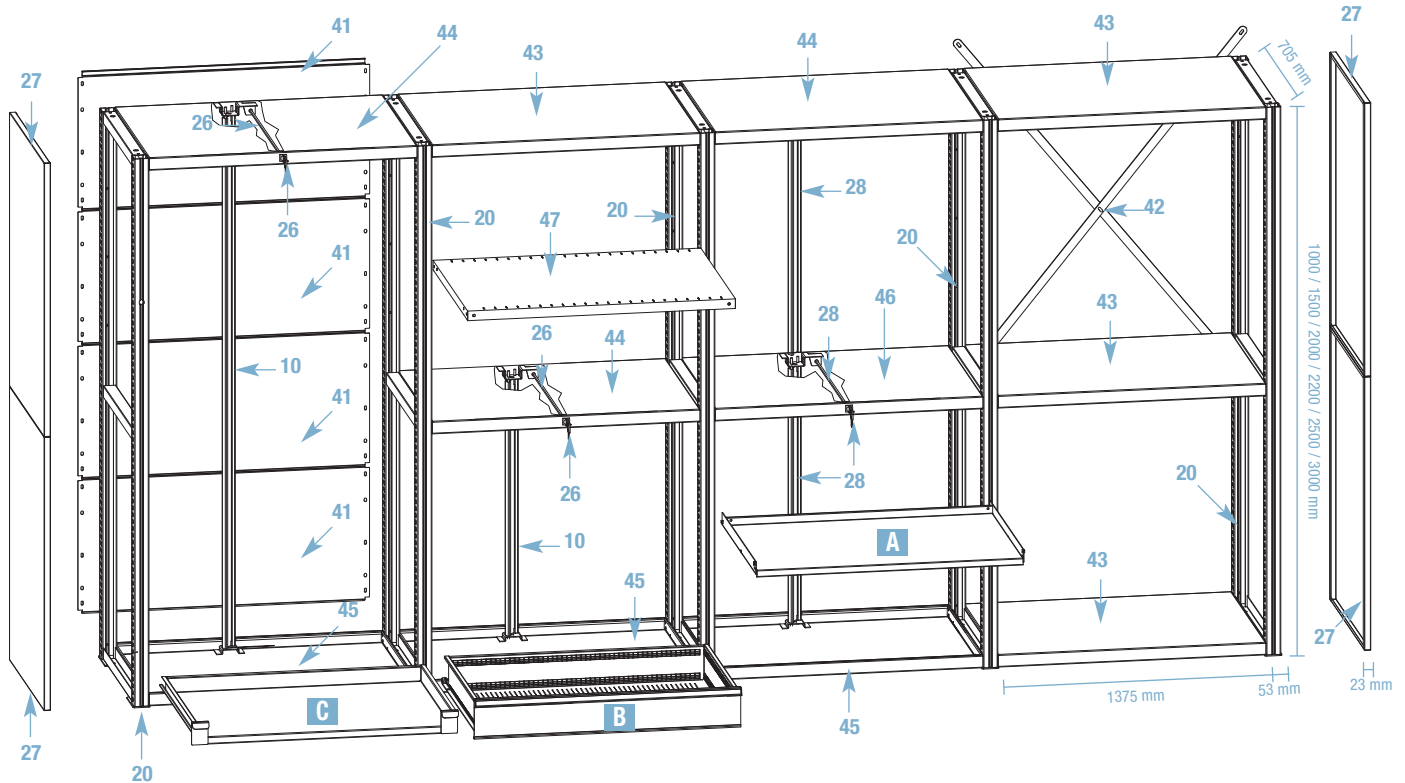

- Accessories see page F62
- Roller shutters, doors and safety ladders page F63 - F65

**FIXING SET**



Fixing material including (for 1 upright frame) no. 2 steel floor bolts M10x90 mm for uninterrupted concrete floors equal to or higher than class: B25 / RBK250 / MP<sub>A</sub> 25N for mm<sup>2</sup>.

ORD. NO. F SR 8999 00 99

- Shelving must be fixed to the wall or floor.

**LOAD CAPACITY PER BAY**

Load capacity per bay kg	For distance between universal or locking shelves mm
4500	2000
5000	1500
5500	1000

**REQUIRED QUANTITY OF UNIVERSAL OR LOCKING SHELVES PER BAY**

Shelving height mm	Quantity of universal or locking shelves
1000	2
1500	2
2000	2
2200	3
2500	3
3000	3

**20 UPRIGHT FRAMES** ■ 01 ■ 02 ■ 04 ■ 08

ORD. NO.	DIM. mm
*F SR 0710 01 04	53x705x1000 h
*F SR 0716 01 04	53x705x1500 h
F SR 0720 00 04	53x705x2000 h
F SR 0722 00 04	53x705x2200 h
F SR 0725 00 04	53x705x2500 h
F SR 0730 00 04	53x705x3000 h

\*Including cover panels

**41 BACK PANELS** ■ 01 ■ 02

ORD. NO.	DIM. mm
F SR 2320 00 01	1000 h
F SR 2331 00 01	1500 h
F SR 2340 00 01	2000 h
F SR 2350 00 01	2200 h
F SR 2360 00 01	2500 h
F SR 2370 00 01	3000 h

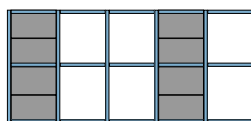

- A back panel must be fitted to each third bay

**42 CROSS BRACINGS** ■ 01 ■ 02

ORD. NO.	For shelving height mm
F SR 7320 00 01	1500 / 2200
F SR 7350 00 01	2500 / 3000

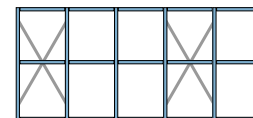

- A cross bracing must be fitted to each third bay

**43 UNIVERSAL SHELVES** ■ 01 ■ 02 ■ 04 ■ 08

ORD. NO.	DIM. mm
F SR 1190 00 04	1375x705x46 h

Load capacity: 250 kg

**47 PERFORATED ADJUSTABLE SHELVES** ■ 01 ■ 02 ■ 04 ■ 08

ORD. NO.	DIM. mm
F SR 1390 01 04	1375x705x35 h

Load capacity: 300 kg

- This type of shelf can be fitted only if anti-tilt rod is not fitted

**44 TOP LOCKING SHELVES** ■ 01 ■ 02 ■ 04 ■ 08

ORD. NO.	DIM. mm
F SR 1590 00 04	1375x705x46 h

Load capacity: 200 kg

WIDTH = 1428 mm DEPTH = 705 mm (78x36 Eh)

SHELVING SYSTEM SYSTEM SR 7836

**45 BOTTOM LOCKING SHELVES** ■ 01 ■ 02 ■ 04 ■ 08

ORD. NO.	DIM. mm
<b>F SR 1690 00 04</b>	1375x705x46 h
Load capacity: <b>200 kg</b>	

**46 INTERMEDIATE LOCKING SHELVES** ■ 01 ■ 02 ■ 04 ■ 08

ORD. NO.	DIM. mm
<b>F SR 1790 00 04</b>	1375x705x46 h
Load capacity: <b>200 kg</b>	

**27 SIDE PANELS** ■ 01 ■ 02 ■ 04 ■ 08

ORD. NO.	DIM. mm
<b>F SR 2455 00 04</b>	23x705x1000 h
<b>F SR 2460 00 04</b>	23x705x1100 h
<b>F SR 2465 00 04</b>	23x705x1250 h
<b>F SR 2475 00 04</b>	23x705x1500 h

**26 LOCKING SET**

ORD. NO.	For shelving depth mm
<b>F SR 8102 00 00</b>	705
Including 1 lock with 2 keys, 1 square rod, 1 anti-tilt rod activation group.	
■ Spare key see page <b>F42</b>	
<b>Spare key</b> (for lock ref. 26)	
<b>ORD. NO. R CSR 0003 00</b>	

**28 LOCKING SYSTEM TOTAL HEIGHT** ■ 01

ORD. NO.	Rod height mm	For frame height ref. 1 mm
<b>F SR 8310 51 01</b>	900+950 h	2000 h
<b>F SR 8330 51 01</b>	900+1150 h	2200 h
<b>F SR 8350 51 01</b>	900+1450 h	2500 h
<b>F SR 8370 51 01</b>	1400+1450 h	3000 h

**10 ANTI-TILT ROD** ■ 01

ORD. NO.	Rod height mm
<b>F AG 9116 00 01</b>	300
<b>F AG 9124 00 01</b>	500
<b>F AG 9128 00 01</b>	600
<b>F AG 9132 00 01</b>	700
<b>F AG 9133 00 01</b>	725
<b>F AG 9134 00 01</b>	750
<b>F AG 9140 00 01</b>	900
<b>F AG 9146 00 01</b>	1050
<b>F AG 9150 00 01</b>	1150
<b>F AG 9153 00 01</b>	1225
<b>F AG 9160 00 01</b>	1400
<b>F AG 9165 00 01</b>	1525
<b>F AG 9170 00 01</b>	1650
<b>F AG 9180 00 01</b>	1900

■ It is necessary to fit an anti-tilt rod if drawers or extension shelves are installed



**C TELESCOPIC FULL EXTENSION SHELVES (PE-TT)** ■ 01 ■ 02 ■ 04 ■ 08

ORD. NO.	Usable dim. mm
<b>F FG 8170 00 04</b>	1324x610
Side height: -	
Load capacity: <b>150 kg</b>	
Extension: 100%	

**A ADJUSTABLE SHELVES** ■ 01 ■ 02 ■ 04 ■ 08

ORD. NO.	DIM. mm
<b>F SR 1290 01 04</b>	1375x618x35 h
Load capacity: <b>150 kg</b>	
■ This type of shelf can be fitted even if <b>anti-tilt rod</b> is fitted	

**B TELESCOPIC FULL EXTENSION DRAWERS (TT)** ■ 01 ■ 02 ■ 04 ■ 08

ORD. NO.	Usable dim. mm	Front height	Load capacity kg	Extension
<b>F FG 7107 00 04</b>	1314x600x54 h	75	150	100%
<b>F FG 7110 00 04</b>	1314x600x79 h	100	150	100%
<b>F FG 7112 00 04</b>	1314x600x104 h	125	150	100%
<b>F FG 7115 00 04</b>	1314x600x129 h	150	150	100%
<b>F FG 7117 00 04</b>	1314x600x154 h	175	150	100%
<b>F FG 7120 00 04</b>	1314x600x179 h	200	150	100%
<b>F FG 7125 00 04</b>	1314x600x229 h	250	150	100%
<b>F FG 7130 00 04</b>	1314x600x279 h	300	150	100%



■ Set of partitions see page **A137**

## SHELVING SYSTEM SYSTEM SR 0705

## COVER PANELS

■ 01 ■ 02  
■ 04 ■ 08

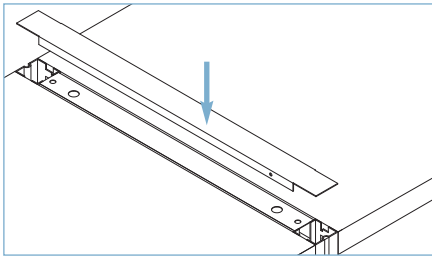

## ORD. NO.

**F SR 2560 00 04**

For shelving depth 705 mm

## INFIL PANELS

■ 01 ■ 02  
■ 04 ■ 08

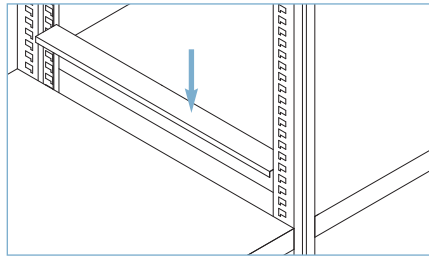

## ORD. NO.

**F SR 2760 00 04**

For shelving depth 705 mm

## SHELF SIDE PANELS

■ 01 ■ 02

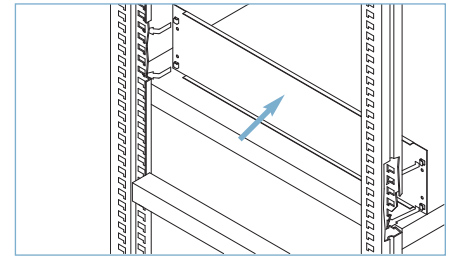

## ORD. NO.

HEIGHT mm h

**F SR 2660 00 01**

150

**F SR 2670 00 01**

200

**F SR 2680 00 01**

250

For shelving depth 705 mm

## PARTITIONS

■ 01 ■ 02

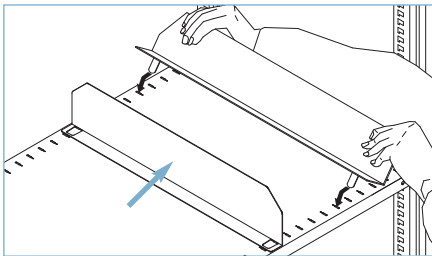

## ORD. NO.

HEIGHT mm h

**F SR 2860 00 01**

95

**F SR 2880 00 01**

145

**F SR 2890 00 01**

195

For shelving depth 705 mm

## HOOK



■ 99

## ORD. NO.

**F SL 1910 00 99**

Galvanised hook for adjustable shelf

## DRAWING POCKETS



## ORD. NO.

DIMENSIONS mm

**C MV 15 005**

332x210 h DIN A4

**C MV 15 006**

218x148 h DIN A5

## MAGNETIC SUPPORT WITH LABEL



## ORD. NO.

**F ST 9997 00 00**Magnetic support with label and cellophane  
Length 1000 mm

## ORD. NO.

**R FST 0007 00**

Spare label and cellophane (100 pcs)

## MULTIPLEX WORKTOP

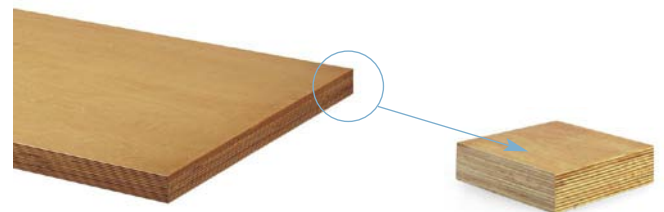

## ORD. NO.

DIMENSIONS mm

**F SR 0070 00 00**

967x705x40 h

**F SR 0080 00 00**

1137x705x40 h

**F SR 0090 00 00**

1375x705x40 h



Using the Multiplex worktop

## ROLLER SHUTTER FOR UNIVERSAL SHELVING SYSTEM SERIES SR

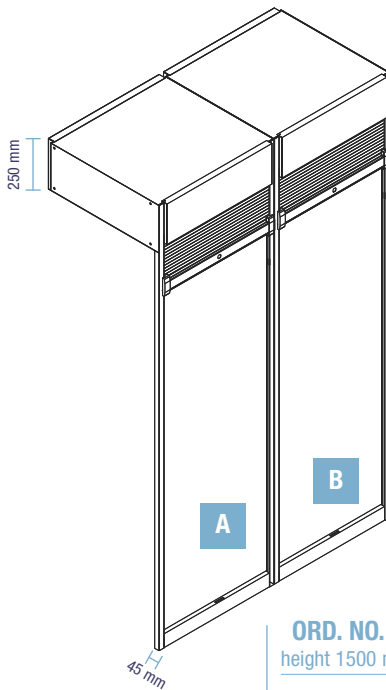

■ It is not possible to fit a roller shutter on shelving with vertical drawers 1715/1915/2215 mm high.

■ It is not possible to fit a roller shutter if the next bay is fitted with sliding doors or leaf doors

■ Spare key see page F42

**Spare lock** (for roller shutters)  
**ORD. NO. R CSR 0006 00**

■ 01 ■ 02 ■ 04 ■ 08

ORD. NO. height 1500 mm h	ORD. NO. height 2000 mm h	ORD. NO. height 2200 mm h	ORD. NO. height 2500 mm h	DOOR TYPE
F SR 6022 00 04	F SR 6030 00 04	F SR 6040 00 04	F SR 6050 00 04	Single roller shutter 36 Eh (A)
F SR 6023 00 04	F SR 6031 00 04	F SR 6041 00 04	F SR 6051 00 04	Add-on unit 36 Eh (B)
F SR 6122 00 04	F SR 6130 00 04	F SR 6140 00 04	F SR 6150 00 04	Single roller shutter 54 Eh (A)
F SR 6123 00 04	F SR 6131 00 04	F SR 6141 00 04	F SR 6151 00 04	Add-on unit 54 Eh (B)
F SR 6222 00 04	F SR 6230 00 04	F SR 6240 00 04	F SR 6250 00 04	Single roller shutter 64 Eh (A)
F SR 6223 00 04	F SR 6231 00 04	F SR 6241 00 04	F SR 6251 00 04	Add-on unit 64 Eh (B)
F SR 6322 00 04	F SR 6330 00 04	F SR 6340 00 04	F SR 6350 00 04	Single roller shutter 2x36 Eh (A)
F SR 6323 00 04	F SR 6331 00 04	F SR 6341 00 04	F SR 6351 00 04	Add-on unit 2x36 Eh (B)
F SR 6422 00 04	F SR 6430 00 04	F SR 6440 00 04	F SR 6450 00 04	Single roller shutter 78 Eh (A)
F SR 6423 00 04	F SR 6431 00 04	F SR 6441 00 04	F SR 6451 00 04	Add-on unit 78 Eh (B)

Complete with safety lock and 2 keys

## SIDE PANELS FOR SHELVING WITH ROLLER SHUTTER

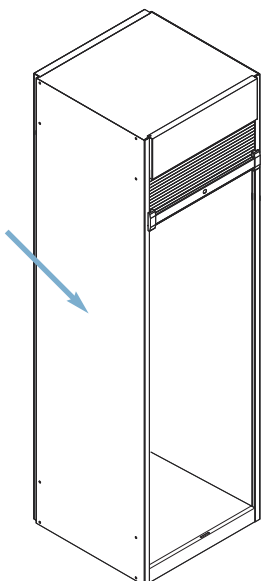

■ 01 ■ 02 ■ 04 ■ 08

ORD. NO. left hand side	ORD. NO. right hand side	FRAME HEIGHT mm	SIDE PANELS HEIGHT (with roller shutter mm)
F SR 6623 00 04	F SR 6622 00 04	1500	1750
F SR 6631 00 04	F SR 6630 00 04	2000	2250
F SR 6641 00 04	F SR 6640 00 04	2200	2450
F SR 6651 00 04	F SR 6650 00 04	2500	2750

For universal shelving 553 mm depth

■ 01 ■ 02 ■ 04 ■ 08

ORD. NO. left hand side	ORD. NO. right hand side	FRAME HEIGHT mm	SIDE PANELS HEIGHT (with roller shutter mm)
F SR 6723 00 04	F SR 6722 00 04	1500	1750
F SR 6731 00 04	F SR 6730 00 04	2000	2250
F SR 6741 00 04	F SR 6740 00 04	2200	2450
F SR 6751 00 04	F SR 6750 00 04	2500	2750

For universal shelving 705 mm depth



## SHELVING SYSTEM SYSTEM SR 1000

WIDTH = 780/1020 mm (36/54 Eh)

## LEAF DOORS 780 mm WIDTH (36 EH)

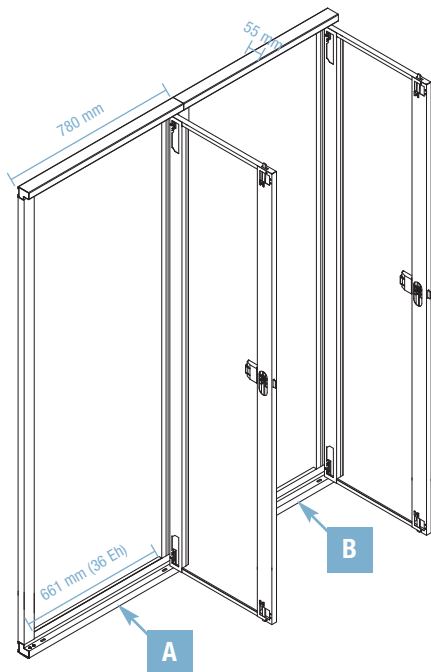

■ 01 ■ 02 ■ 04 ■ 08

## ORD. NO.

height 2000 mm h

DOOR TYPE

**F SR 5030 00 04**

Single door 36 Eh (A)

**F SR 5031 00 04**

Add-on unit 36 Eh (B)

Complete with safety lock and 2 keys

■ It is not possible to fit a leaf door on shelving with vertical drawers 1715/1915/2215 mm high

■ It is not possible to fit leaf doors if the next bay is fitted with sliding doors or roller shutter

Spare lock (for leaf doors)

ORD. NO. R CSR 0008 00

## LEAF DOORS 1020 mm WIDTH (54 EH)

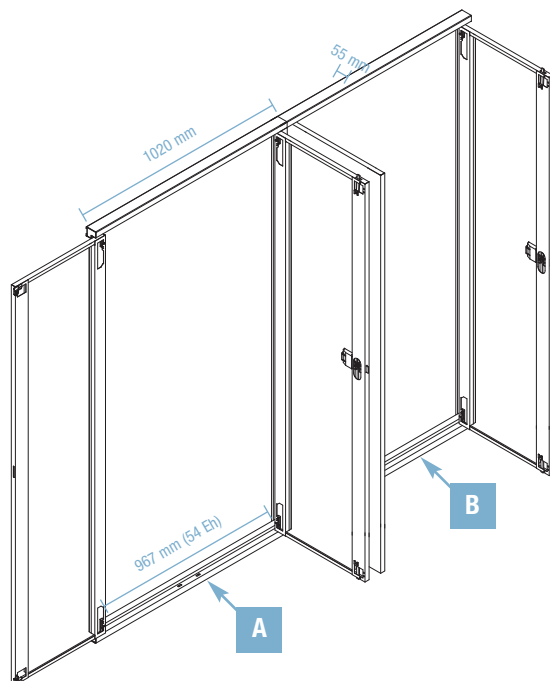

■ 01 ■ 02 ■ 04 ■ 08

## ORD. NO.

height 1000 mm h

## ORD. NO.

height 2000 mm h

DOOR TYPE

**F SR 5310 00 04****F SR 5330 00 04**

Single door 36 Eh (A)

**F SR 5311 00 04****F SR 5331 00 04**

Add-on unit 36 Eh (B)

Complete with safety lock and 2 keys

■ It is not possible to fit a leaf door on shelving with vertical drawers 1715/1915/2215 mm high

■ It is not possible to fit leaf doors if the next bay is fitted with sliding doors or roller shutter

Spare lock (for leaf doors)

ORD. NO. R CSR 0011 00

RAL 7000 F. ....01

RAL 6011 F. ....02

RAL 5012 F. ....04

RAL 7035 F. ....08

## SUPPLEMENTARY PARTS ■

■ **Spare key.** Always indicate the number on the cylinder lock of the key to be replaced.

ORD. NO. R CSC 0002 00

■ **Master key.** This type of key opens all the 45 and 46 series locks.

ORD. NO. R CSC 0001 00



SHELVING SYSTEM SYSTEM SR 1000

SLIDING DOORS

ORD. NO. height 2000 mm h	ORD. NO. height 2200 mm h	ORD. NO. height 2500 mm h	DOOR TYPE
F SR 5530 00 04	F SR 5540 00 04	F SR 5550 00 04	Single door 2x36 Eh (A)
F SR 5531 00 04	F SR 5541 00 04	F SR 5551 00 04	Add-on unit 2x36 Eh (B)
F SR 5630 00 04	F SR 5640 00 04	F SR 5650 00 04	Single door 2x54 Eh (A)
F SR 5631 00 04	F SR 5641 00 04	F SR 5651 00 04	Add-on unit 2x54 Eh (B)
F SR 5730 00 04	-	-	Single door 2x64 Eh (A)
F SR 5731 00 04	-	-	Add-on unit 2x64 Eh (B)
F SR 5830 00 04	-	-	Single door 2x78 Eh (A)
F SR 5831 00 04	-	-	Add-on unit 2x78 Eh (B)

■ 01 ■ 02 ■ 04 ■ 08

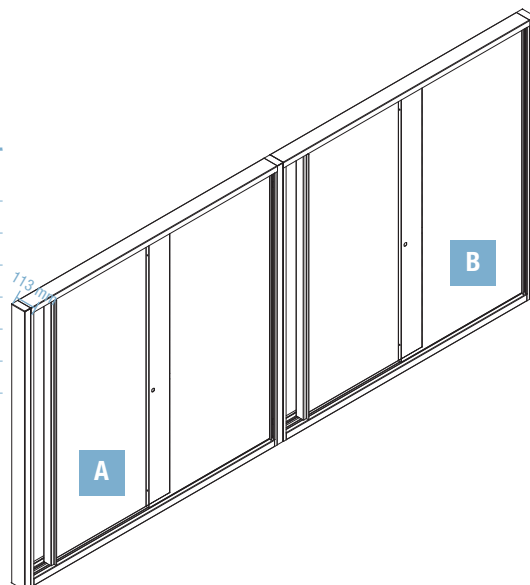

- It is not possible to fit a leaf door on shelving with vertical drawers 1715/1915/2215 mm high
- It is not possible to fit sliding doors if the next bay is fitted with leaf doors or roller shutter

■ Spare key see page F64

Spare lock (for sliding doors) ORD. NO. R CSR 0012 00

SAFETY LADDERS

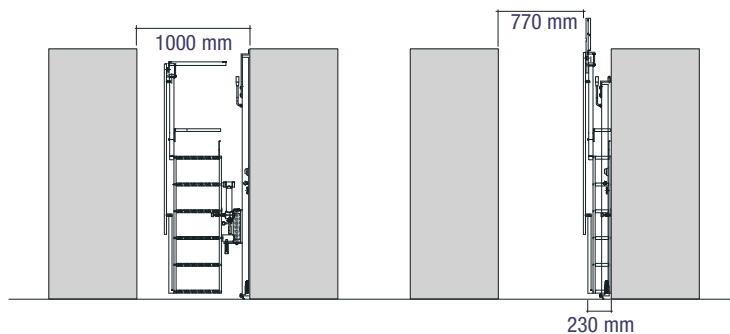

ORD. NO. (A)	FOR SHELVING HEIGHT mm
F QG 6220 00 30	2200
F QG 6250 00 30	2500
F QG 6300 00 30	3000

ORD. NO.	■ 01 ■ 02 ■ 04 ■ 08
F QG 9600 00 04	
Upper and lower guide rails per linear meter	
Guide rails for shelving without doors	

ORD. NO.	■ 01 ■ 02 ■ 04 ■ 08
F QG 9601 00 04	
Upper and lower guide rails per linear meter	
Guide rails for shelving with leaf doors	

ORD. NO.	■ 01 ■ 02 ■ 04 ■ 08
F QG 9602 00 04	
Upper and lower guide rails per linear meter	
Guide rails for shelving with sliding doors	

■ INFO

RAL 7000 F. ....01 RAL 6011 F. ....02 RAL 5012 F. ....04 RAL 7035 F. ....08



www.famispaspa.com



SHELVING SYSTEM SYSTEM SR V3

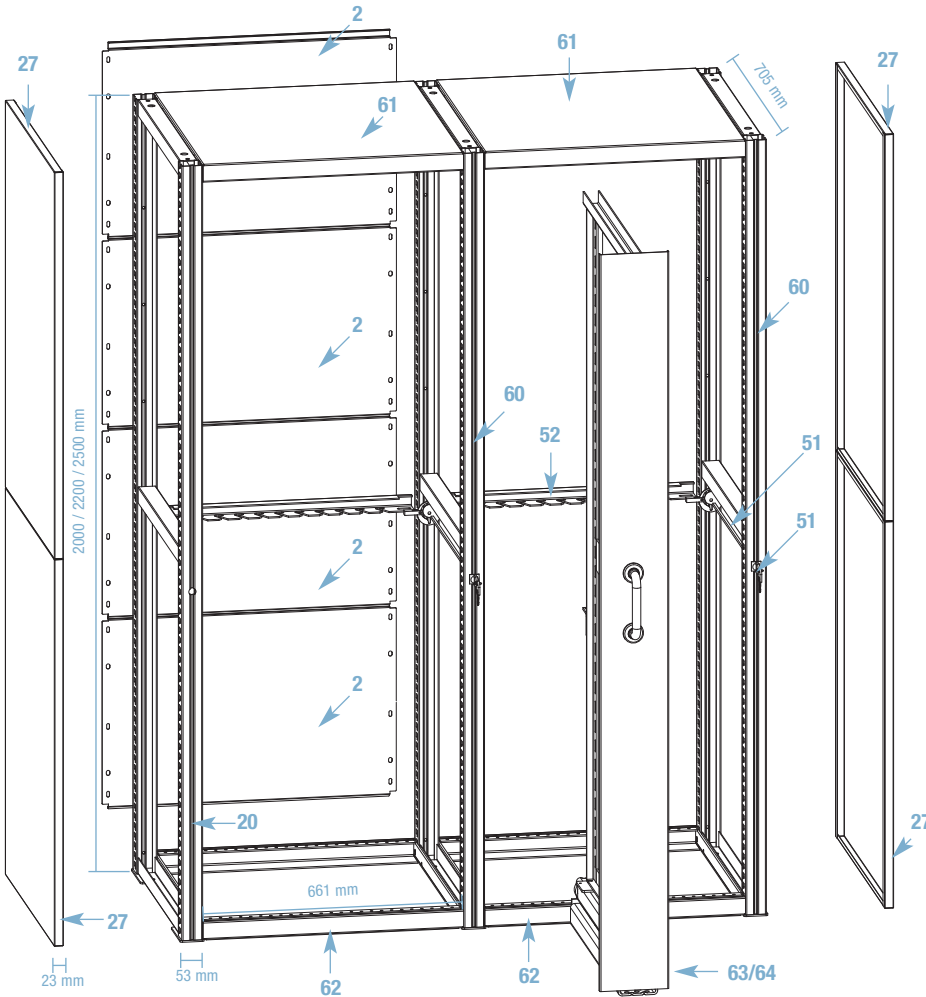

- Accessories see page F62
- Shelving must be fixed to the wall or floor
- Further information for fixing set and load capacity see page F52

**51+52 LOCKING SET**

■ 01

ORD. NO.	WIDTH mm
<b>F SR 4060 00 01</b>	661
Including 1 lock with 2 keys, 1 square rod, 1 anti-tilt rod activation group	
■ Spare key (for lock ref. 51) ORD. NO. R CSR 0003 00	
■ Spare key see page F64	

**20 UPRIGHT FRAMES**

■ 01 ■ 02 ■ 04 ■ 08

ORD. NO.	DIM. mm
<b>F SR 0720 00 04</b>	53x705x2000 h
<b>F SR 0722 00 04</b>	53x705x2200 h
<b>F SR 0725 00 04</b>	53x705x2500 h

**27 SIDE PANELS**

■ 01 ■ 02 ■ 04 ■ 08

ORD. NO.	DIM. mm
<b>F SR 2455 00 04</b>	23x705x1000 h
<b>F SR 2460 00 04</b>	23x705x1100 h
<b>F SR 2465 00 04</b>	23x705x1250 h
<b>F SR 2475 00 04</b>	23x705x1500 h

**52 ANTI-TILT ROD**

■ 01

ORD. NO.	WIDTH mm
<b>F SR 4010 00 01</b>	661
■ It is necessary to fit an anti-tilt rod if drawers are installed	

**60 UPRIGHT FRAMES WITH HOLE FOR LOCK**

■ 01 ■ 02 ■ 04 ■ 08

ORD. NO.	DIM. mm
<b>F SR 0721 00 04</b>	53x705x2000 h
<b>F SR 0723 00 04</b>	53x705x2200 h
<b>F SR 0726 00 04</b>	53x705x2500 h
Upright frames with hole for lock for vertical drawers	

**2 BACK PANELS**

■ 01 ■ 02

ORD. NO.	DIM. mm
<b>F SR 2040 00 01</b>	2000 h
<b>F SR 2050 00 01</b>	2200 h
<b>F SR 2060 00 01</b>	2500 h

**62 BOTTOM SHELVES FOR VERTICAL DRAWERS**

■ 01 ■ 02 ■ 04 ■ 08

ORD. NO.	DIM. mm
<b>F SR 4110 00 04</b>	661x705x46 h

**61 TOP SHELVES FOR VERTICAL DRAWERS**

■ 01 ■ 02 ■ 04 ■ 08

ORD. NO.	DIM. mm
<b>F SR 4160 00 04</b>	661x705x46 h
Load capacity: 200 kg	

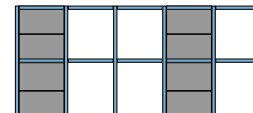

■ A back panel must be fitted to each third bay

WIDTH = 714 mm DEPTH = 705 mm (36x36 Eh)

SHELVING SYSTEM SYSTEM SR V3

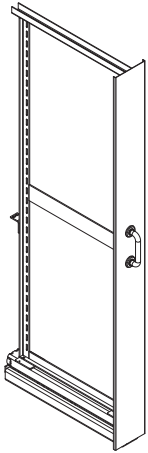

■ Accessories see page F74 - F75

**63 VERTICAL DRAWERS 1 SIDE STORAGE**

01 02  
51 56

ORD. NO. 1715 mm h	ORD. NO. 1915 mm h	ORD. NO. 2215 mm h	FRONT WIDTH mm	USABLE WIDTH mm	LOAD CAP. KG
F SR 3110 00 51	F SR 3210 00 51	F SR 3310 00 51	100	68	400
F SR 3115 00 51	F SR 3215 00 51	F SR 3315 00 51	125	93	400
F SR 3120 00 51	F SR 3220 00 51	F SR 3320 00 51	150	118	400
F SR 3125 00 51	F SR 3225 00 51	F SR 3325 00 51	175	143	400
F SR 3130 00 51	F SR 3230 00 51	F SR 3330 00 51	200	168	400
F SR 3135 00 51	F SR 3235 00 51	F SR 3335 00 51	225	193	400
F SR 3140 00 51	F SR 3240 00 51	F SR 3340 00 51	250	212	400
<b>Usable height mm</b>	<b>1715</b>	<b>1915</b>	<b>2215</b>		
Usable depth mm	620	620	620		
Front height mm	1900	2100	2400		
For shelving height mm	2000	2200	2500		

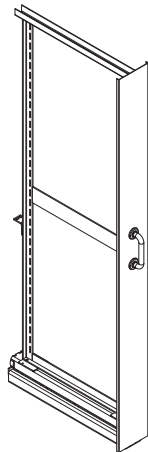

■ Accessories see page F74 - F75

**64 VERTICAL DRAWERS 2 SIDES STORAGE**

01 02  
51 56

ORD. NO. 1715 mm h	ORD. NO. 1915 mm h	ORD. NO. 2215 mm h	FRONT WIDTH mm	USABLE WIDTH mm	LOAD CAP. KG
F SR 3610 00 51	F SR 3710 00 51	F SR 3810 00 51	150	68+68	400
F SR 3615 00 51	F SR 3715 00 51	F SR 3815 00 51	175	68+93	400
F SR 3620 00 51	F SR 3720 00 51	F SR 3820 00 51	200	93+93	400
F SR 3625 00 51	F SR 3725 00 51	F SR 3825 00 51	200	68+118	400
F SR 3630 00 51	F SR 3730 00 51	F SR 3830 00 51	225	93+118	400
F SR 3635 00 51	F SR 3735 00 51	F SR 3835 00 51	225	68+143	400
F SR 3640 00 51	F SR 3740 00 51	F SR 3840 00 51	250	118+118	400
F SR 3645 00 51	F SR 3745 00 51	F SR 3845 00 51	250	93+143	400
F SR 3650 00 51	F SR 3750 00 51	F SR 3850 00 51	250	68+168	400
<b>Usable height mm</b>	<b>1715</b>	<b>1915</b>	<b>2215</b>		
Usable depth mm	620	620	620		
Front height mm	1900	2100	2400		
For shelving height mm	2000	2200	2500		

**EXAMPLE OF VERTICAL DRAWERS**

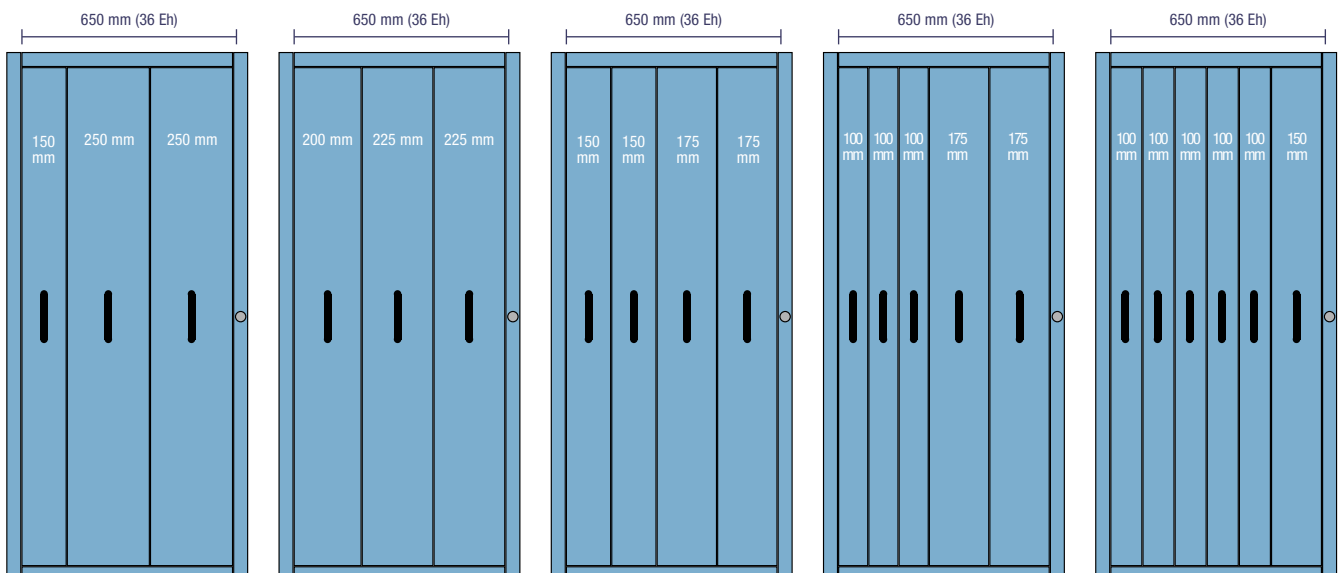

SHELVING SYSTEM SYSTEM SR V4

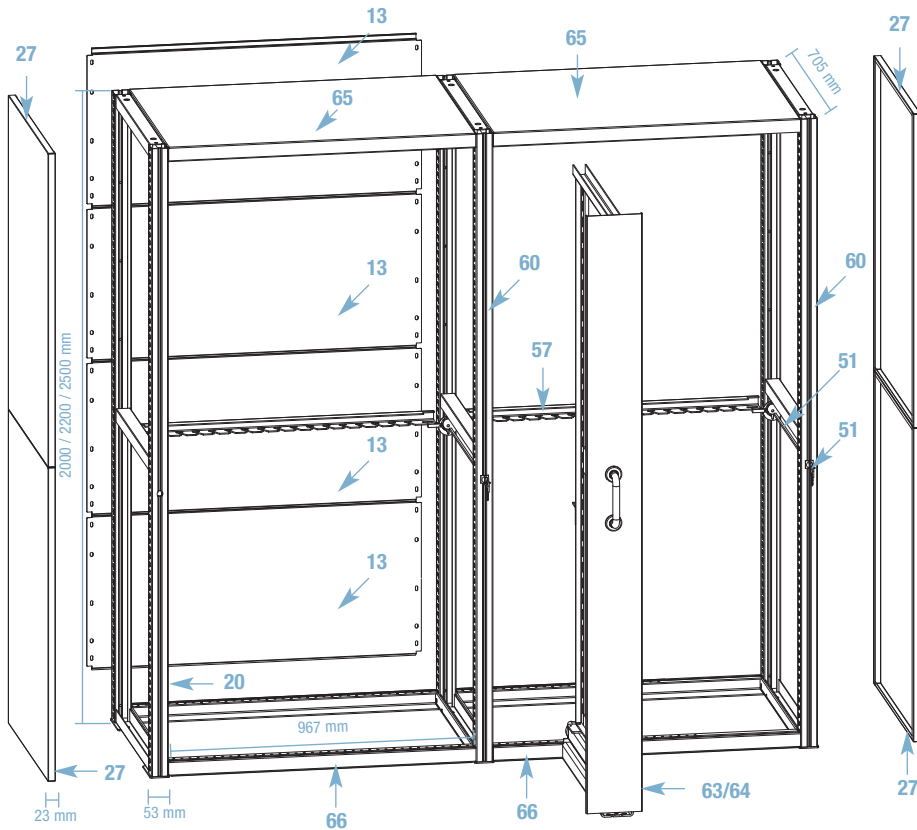

- Accessories see page F62
- Shelving must be fixed to the wall or floor
- Further information for fixing set and load capacity see page F56

**51+57 LOCKING SET** ■ 01

ORD. NO.	WIDTH mm
<b>F SR 4070 00 01</b>	967
Including 1 lock with 2 keys, 1 square rod, 1 anti-tilt rod activation group	
■ Spare key (for lock ref. 51) ORD. NO. R CSR 0003 00	
■ Spare key see page F64	

**20 UPRIGHT FRAMES** ■ 01 ■ 02 ■ 04 ■ 08

ORD. NO.	DIM. mm
<b>F SR 0720 00 04</b>	53x705x2000 h
<b>F SR 0722 00 04</b>	53x705x2200 h
<b>F SR 0725 00 04</b>	53x705x2500 h

**27 SIDE PANELS** ■ 01 ■ 02 ■ 04 ■ 08

ORD. NO.	DIM. mm
<b>F SR 2455 00 04</b>	23x705x1000 h
<b>F SR 2460 00 04</b>	23x705x1100 h
<b>F SR 2465 00 04</b>	23x705x1250 h
<b>F SR 2475 00 04</b>	23x705x1500 h

**57 ANTI-TILT ROD** ■ 01

ORD. NO.	WIDTH mm
<b>F SR 4020 00 01</b>	967
■ It is necessary to fit an anti-tilt rod if drawers are installed	

**60 UPRIGHT FRAMES WITH HOLE FOR LOCK** ■ 01 ■ 02 ■ 04 ■ 08

ORD. NO.	DIM. mm
<b>F SR 0721 00 04</b>	53x705x2000 h
<b>F SR 0723 00 04</b>	53x705x2200 h
<b>F SR 0726 00 04</b>	53x705x2500 h
Upright frames with hole for lock for vertical drawers	

**13 BACK PANELS** ■ 01 ■ 02

ORD. NO.	DIM. mm
<b>F SR 2140 00 01</b>	2000 h
<b>F SR 2150 00 01</b>	2200 h
<b>F SR 2160 00 01</b>	2500 h

**66 BOTTOM SHELVES FOR VERTICAL DRAWERS** ■ 01 ■ 02 ■ 04 ■ 08

ORD. NO.	DIM. mm
<b>F SR 4120 00 04</b>	967x705x46 h

**65 TOP SHELVES FOR VERTICAL DRAWERS** ■ 01 ■ 02 ■ 04 ■ 08

ORD. NO.	DIM. mm
<b>F SR 4170 00 04</b>	967x705x46 h
Load capacity: 200 kg	

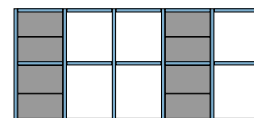

■ A back panel must be fitted to each third bay

WIDTH = 1020 mm DEPTH = 705 mm (54x36 Eh)

SHELVING SYSTEM SYSTEM SR V4

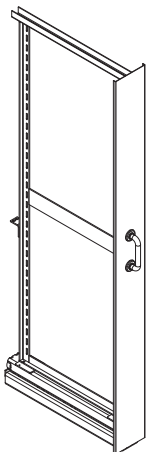

■ Accessories see page F74 - F75

**63 VERTICAL DRAWERS 1 SIDE STORAGE**

01 02  
51 56

ORD. NO. 1715 mm h	ORD. NO. 1915 mm h	ORD. NO. 2215 mm h	FRONT WIDTH mm	USABLE WIDTH mm	LOAD CAP. KG
F SR 3110 00 51	F SR 3210 00 51	F SR 3310 00 51	100	68	400
F SR 3115 00 51	F SR 3215 00 51	F SR 3315 00 51	125	93	400
F SR 3120 00 51	F SR 3220 00 51	F SR 3320 00 51	150	118	400
F SR 3125 00 51	F SR 3225 00 51	F SR 3325 00 51	175	143	400
F SR 3130 00 51	F SR 3230 00 51	F SR 3330 00 51	200	168	400
F SR 3135 00 51	F SR 3235 00 51	F SR 3335 00 51	225	193	400
F SR 3140 00 51	F SR 3240 00 51	F SR 3340 00 51	250	212	400
<b>Usable height mm</b>	<b>1715</b>	<b>1915</b>	<b>2215</b>		
Usable depth mm	620	620	620		
Front height mm	1900	2100	2400		
For shelving height mm	2000	2200	2500		

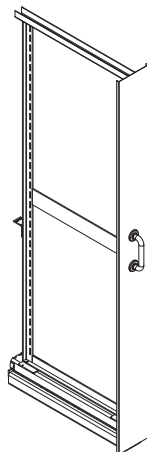

■ Accessories see page F74 - F75

**64 VERTICAL DRAWERS 2 SIDES STORAGE**

01 02  
51 56

ORD. NO. 1715 mm h	ORD. NO. 1915 mm h	ORD. NO. 2215 mm h	FRONT WIDTH mm	USABLE WIDTH mm	LOAD CAP. KG
F SR 3610 00 51	F SR 3710 00 51	F SR 3810 00 51	150	68+68	400
F SR 3615 00 51	F SR 3715 00 51	F SR 3815 00 51	175	68+93	400
F SR 3620 00 51	F SR 3720 00 51	F SR 3820 00 51	200	93+93	400
F SR 3625 00 51	F SR 3725 00 51	F SR 3825 00 51	200	68+118	400
F SR 3630 00 51	F SR 3730 00 51	F SR 3830 00 51	225	93+118	400
F SR 3635 00 51	F SR 3735 00 51	F SR 3835 00 51	225	68+143	400
F SR 3640 00 51	F SR 3740 00 51	F SR 3840 00 51	250	118+118	400
F SR 3645 00 51	F SR 3745 00 51	F SR 3845 00 51	250	93+143	400
F SR 3650 00 51	F SR 3750 00 51	F SR 3850 00 51	250	68+168	400
<b>Usable height mm</b>	<b>1715</b>	<b>1915</b>	<b>2215</b>		
Usable depth mm	620	620	620		
Front height mm	1900	2100	2400		
For shelving height mm	2000	2200	2500		

**EXAMPLE OF VERTICAL DRAWERS**

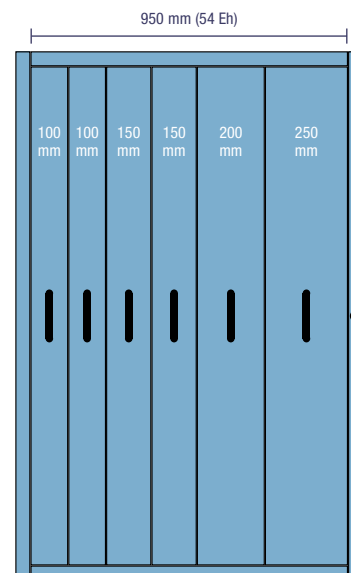
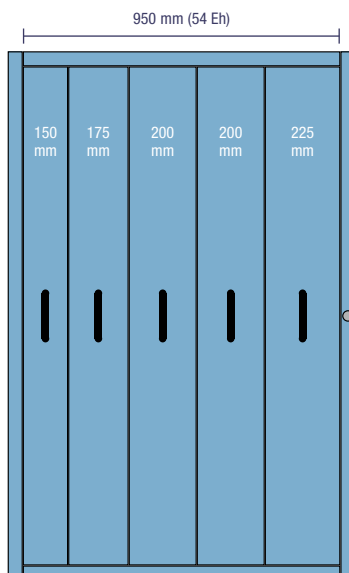
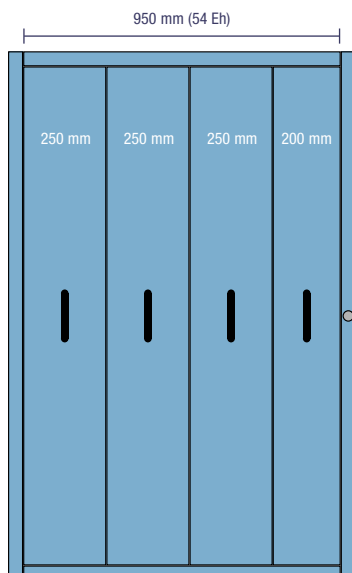

SHELVING SYSTEM SYSTEM SR V34

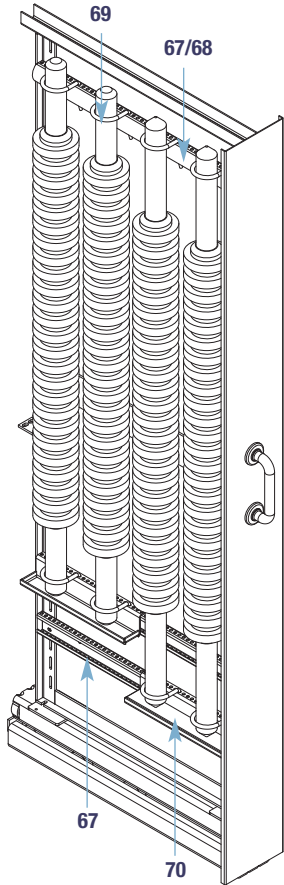

**70** BOTTOM SHELVES WITH WOODEN INSERT

ORD. NO.	DIM. mm
F SR 4260 01 01	310x50
F SR 4265 01 01	310x75
F SR 4270 01 01	310x100
F SR 4275 01 01	310x125
F SR 4280 01 01	310x150

■ Load capacity 150 kg

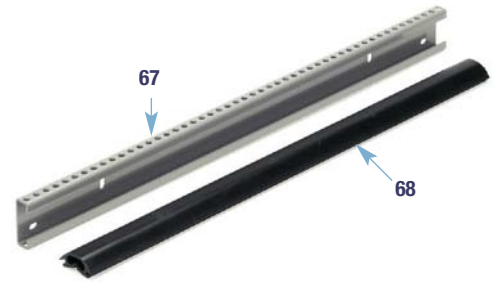

**67** TRAVERSE HOLDERS

■ 01 ■ 02

ORD. NO.	DIM. mm
F CN 3010 00 01	623x28x50 h

**68** NEOPRENE PROFILE

■ 07

ORD. NO.	DIM. mm
F CN 3030 00 07	-

**VERTICAL DRAWER  
2 SIDES STORAGE**

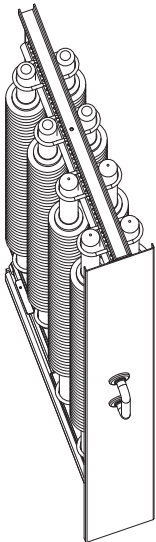

**VERTICAL DRAWER  
1 SIDE STORAGE**

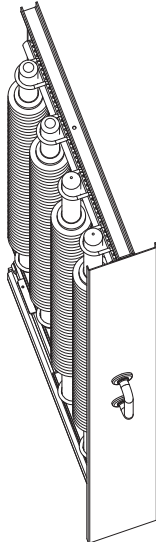

**VERTICAL DRAWER  
2 SIDES STORAGE**

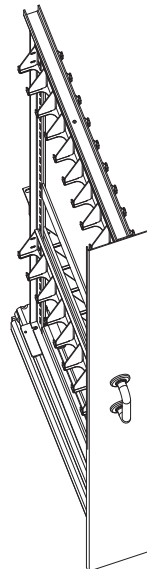

**VERTICAL DRAWER  
1 SIDE STORAGE**

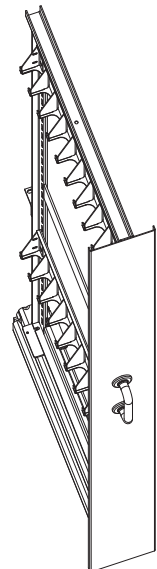

**TOOL HANGING FRAME**

ORD. NO.	FOR TOOLS	FLANGE Ø MAX. mm	SHANK Ø MAX. mm	TOOL Q.TY	WIDTH mm	DEPTH mm	FOR VERTICAL DRAWER WITH USABLE WIDTH mm
F CN 3210 00 01	ISO 40	63	50	9	597	56	68
F CN 3220 00 01	ISO 45	82	63	7	597	75	93
F CN 3230 00 01	ISO 50	98	80	5	597	84	118
F CN 3240 00 01	ISO 50	112	80	5	597	100	118
F CN 3250 00 01	ISO 50	98	80	6	623	84	118
F CN 3260 00 01	ISO 55	130	89	4	597	120	143
F CN 3270 00 01	ISO 60	160	109	3	597	140	168



■ 01 ■ 02

**69 TOOL RETENTION HOLDERS**

ORD. NO.	FOR TOOL Ø MAX. mm	MAX Q.TY RETENTION HOLDERS	UNITS Q.TY PER RETENTION HOLDERS
F CN 3105 00 99	15	16	2
F CN 3110 00 99	27	12	3
F CN 3115 00 99	35	9	4
F CN 3120 00 99	48	8	5
F CN 3125 00 99	60	6	6
F CN 3130 00 99	73	6	7
F CN 3135 00 99	85	5	8
F CN 3140 00 99	98	4	9
F CN 3145 00 99	110	4	10
F CN 3150 00 99	123	4	11
F CN 3155 00 99	135	3	12

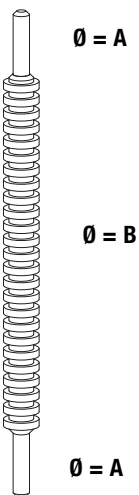
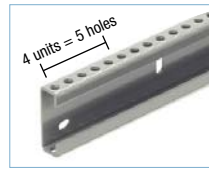

**REQUIREMENTS FOR RETENTION HOLDERS**

ORD. NO.	DRAWERS FRONT WIDTH	TOOL Ø mm (A)	TOOL Ø mm (B)
F CN 3115 00 99	100	35	55
F CN 3110 00 99	100	27	68
F CN 3125 00 99	125	60	80
F CN 3120 00 99	125	48	93
F CN 3135 00 99	150	85	105
F CN 3130 00 99	150	73	118
F CN 3145 00 99	175	110	130
F CN 3140 00 99	175	98	143
F CN 3155 00 99	200	135	155

**PERFORATED PANELS**

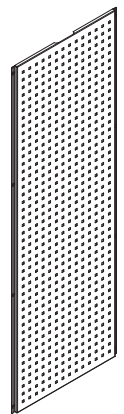

■ 01 ■ 02

ORD. NO.	DIM. mm
F SR 4210 00 01	620x500 h
F SR 4215 00 01	620x1715 h
F SR 4220 00 01	620x1915 h
F SR 4225 00 01	620x2215 h

ORD. NO.	VERT. DRAWERS 2 SIDES STORAGE - LEFT HAND	DRAWERS FRONT WIDTH	TOOL Ø mm (A)	TOOL Ø mm (B)
F CN 3115 00 99	150	150	35	55
F CN 3115 00 99	150	150	35	55
F CN 3110 00 99	150	150	27	68
F CN 3115 00 99	175	175	35	55
F CN 3115 00 99	175	175	35	55
F CN 3110 00 99	175	175	27	68
F CN 3110 00 99	175	175	27	68
F CN 3125 00 99	200	200	60	80
F CN 3125 00 99	200	200	60	80
F CN 3120 00 99	200	200	48	93
F CN 3125 00 99	225	225	60	80
F CN 3125 00 99	225	225	60	80
F CN 3120 00 99	225	225	48	93
F CN 3120 00 99	225	225	48	93
F CN 3135 00 99	250	250	85	105
F CN 3135 00 99	250	250	85	105
F CN 3130 00 99	250	250	73	118

ORD. NO.	VERT. DRAWERS 2 SIDES STORAGE - RIGHT HAND	DRAWERS FRONT WIDTH	TOOL Ø mm (A)	TOOL Ø mm (B)
F CN 3115 00 99	150	150	35	55
F CN 3110 00 99	150	150	27	68
F CN 3110 00 99	150	150	27	68
F CN 3125 00 99	175	175	60	80
F CN 3120 00 99	175	175	48	93
F CN 3125 00 99	175	175	60	80
F CN 3120 00 99	175	175	48	93
F CN 3125 00 99	200	200	60	80
F CN 3120 00 99	200	200	48	93
F CN 3120 00 99	200	200	48	93
F CN 3135 00 99	225	225	85	105
F CN 3130 00 99	225	225	73	118
F CN 3135 00 99	225	225	85	105
F CN 3135 00 99	250	250	85	105
F CN 3130 00 99	250	250	73	118
F CN 3130 00 99	250	250	73	118





