

ORGANIZE SPACE

LET'S REORG



■ **DRAWER CABINETS SERIES FLEXA**

FULL EXTENSION DRAWERS AS STANDARD (100%)

STANDARDISED ELECTRIC AND PNEUMATIC SYSTEMS

VERSATILE

GOOD COMPARISON BETWEEN QUALITY AND PRICE



ORGANIZE SPACE

LET'S REOR

CABINETS SERIES FLEXA



ORD. NO. F DA D550 04 01
RAL 7000

ORD. NO. F DA 1090 S1 08
RAL 7035



FLOOR FIXING SET



2x

- 2 "HILTI" plugs for concrete floors \geq to classes B25/RBK250/MP_A 25 N/mm²
- Recommended traction of the plug: 2.9 KN
- Plug diameter: \varnothing 6 mm

ORD. NO. F AG 9204 00 99

CABINET WITH WHEELS

ORD. NO.	DRAWERS
F DA D550 04 01	5

Complete with 5 drawers
Dimensions mm 428x675x790 h

Partitioning material excluded

CABINET

ORD. NO.	DRAWERS
F DA 1090 S1 08	3

Complete with 3 drawers, 1 600 mm high door
 1 adjustable shelf, 1 retractable shelf
 1 rubber cover top with 3 edges

Dimensions mm 428x600x1000 h

RAL 7000 F.01

RAL 6011 F.02

RAL 5012 F.04

RAL 7035 F.08

SUPPLEMENTARY PARTS ■



■ Partitioning material: see page A9



■ **Spare key.** Always indicate the number on the cylinder lock of the key to be replaced.

ORD. NO. R CSC 0002 00

■ **Master key.** This type of key opens all the 45 and 46 series locks.

ORD. NO. R CSC 0001 00



LENGTH = 428 mm DEPTH = 600 mm (19x27 Eh)

CABINETS SERIES FLEXA



•ORD. NO. DRAWERS
F DZ 1020 51 04 2
 Cabinet with 2 full extension drawers
 Dim. mm 428x600x300 h Side lock



•ORD. NO. DRAWERS
F DZ 1020 52 04 2
 Cabinet with 2 full extension drawers
 Dim. mm 428x600x300 h Side lock



•ORD. NO. DRAWERS
F DZ 1020 53 04 3
 Cabinet with 3 full extension drawers
 Dim. mm 428x600x300 h Side lock



•ORD. NO. DRAWERS
F DZ 1030 51 04 3
 Cabinet with 3 full extension drawers
 Dim. mm 428x600x400 h Side lock



•ORD. NO. DRAWERS
F DZ 1030 52 04 3
 Cabinet with 3 full extension drawers
 Dim. mm 428x600x400 h Side lock



•ORD. NO. DRAWERS
F DZ 1030 53 04 4
 Cabinet with 4 full extension drawers
 Dim. mm 428x600x400 h Side lock



ORD. NO. DRAWERS
F DA 1050 52 04 4
 Cabinet with 4 full extension drawers
 Dim. mm 428x600x600 h Central lock

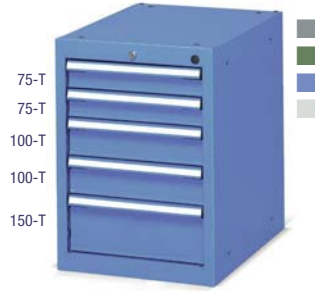

ORD. NO. DRAWERS
F DA 1050 53 04 5
 Cabinet with 5 full extension drawers
 Dim. mm 428x600x600 h Central lock

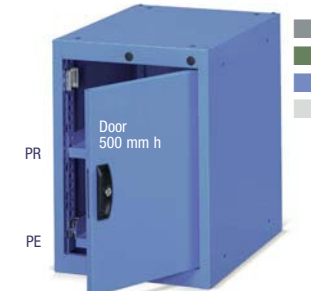

ORD. NO. SHELVES
F DA 1050 55 04 2
 Cabinet with 1 adjustable shelf, 1 retractable shelf 100%
 Dim. mm 428x600x600 h

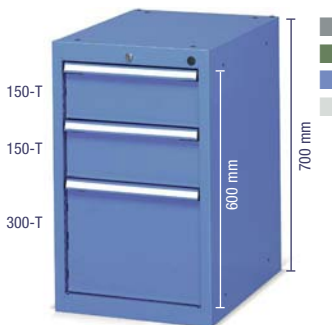

•ORD. NO. DRAWERS
F DA 1060 53 04 3
 Cabinet with 3 full extension drawers
 Dim. mm 428x600x700 h Central lock



•ORD. NO. DRAWERS
F DA 1060 56 04 5
 Cabinet with 5 full extension drawers
 Dim. mm 428x600x700 h Central lock

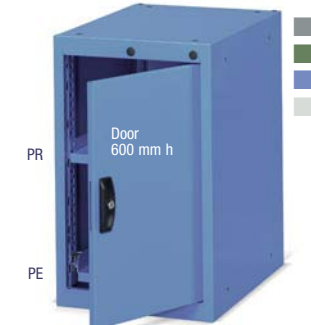

•ORD. NO. SHELVES
F DA 1060 58 04 2
 Cabinet with 1 adjustable shelf, 1 retractable shelf 100%
 Dim. mm 428x600x700 h

KEY

- RAL 7000 F.01
- RAL 6011 F.02
- RAL 5012 F.04
- RAL 7035 F.08



- The cabinets must be secured to the floor or to the wall.
- PE = full extension retractable shelf (100%)
- PR = height adjustable shelf
- T = full extension (100%)

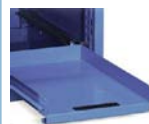

Detail of the full retractable shelves (PE) with load capacity of 70 kg.

Partitioning material: see page A9



LENGTH = 428 mm DEPTH = 600 mm (19x27 Eh)

CABINETS SERIES FLEXA

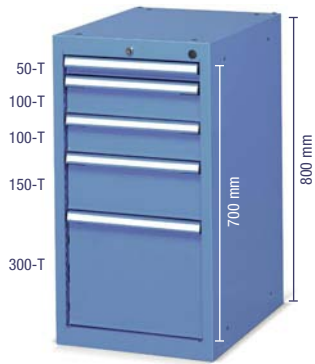

ORD. NO.

DRAWERS

F DA 1070 51 04**5**

Cabinet with 5 full extension drawers

Dimensions mm 428x600x800 h

Central lock



ORD. NO.

DRAWERS

F DA 1070 53 04**6**

Cabinet with 6 full extension drawers

Dimensions mm 428x600x800 h

Central lock

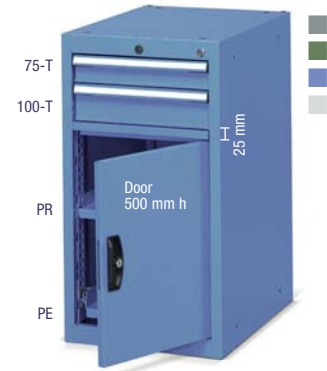

ORD. NO.

DRAWERS

F DZ 1070 55 04**2**

Cabinet with 2 full extension drawers

1 adjustable shelf, 1 retractable shelf 100%

Dim. mm 428x600x800 h

Side lock

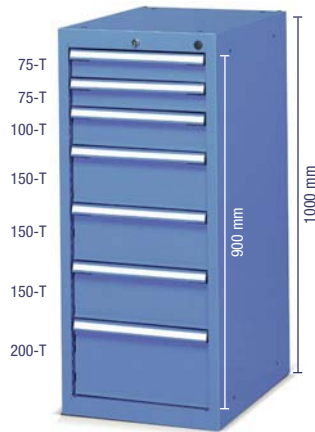

ORD. NO.

DRAWERS

F DA 1090 51 04**7**

Cabinet with 7 full extension drawers

Dimensions mm 428x600x1000 h

Central lock

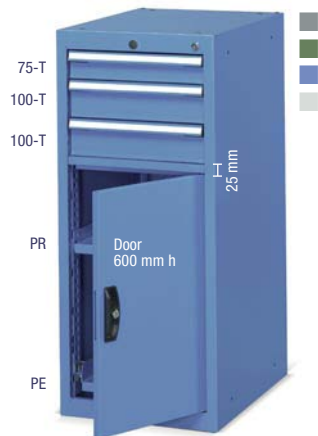

ORD. NO.

DRAWERS

F DZ 1090 52 04**3**

Cabinet with 3 full extension drawers

1 adjustable shelf, 1 retractable shelf 100%

Dim. mm 428x600x1000 h

Side lock

ORD. NO.

DRAWERS

F DA 1090 51 04**7**

Cabinet with 7 full extension drawers

Dimensions mm 428x600x1000 h

Central lock

EXAMPLE INCLUDING:

ORD. NO.

F DA ZA01 00 50

5 cabinets with drawers, doors, adjustable shelves, retractable shelves, MDF tops with rubber covering

Dimensions mm 1576x600x1030 h

Tools excluded



■ RAL 7035 +
■ RAL 5012

RAL 7000 F.01

RAL 6011 F.02

RAL 5012 F.04

RAL 7035 F.08

KEY



■ Partitioning material: see page A9

■ Detail of the full retractable shelves (PE) with load capacity of 70 kg.



- The cabinets must be secured to the floor or to the wall.
- PE = full extension retractable shelf (100%)
- PR = height adjustable shelf
- T = full extension (100%)



LENGTH = 428 mm DEPTH = 600 mm (19x27 Eh)

CABINETS SERIES FLEXA



CABINET WITH WHEELS

ORD. NO.

F DA D550 06 01

Complete with 1 drawer

1 door

1 retractable shelf

Dimensions mm 428x675x752 h

WORKSTATION

ORD. NO.

F BI A242 01 08

Complete with 2 legs

40 mm thick multiplex worktop

Dimensions mm 1500x750x840 h



CABINET WITH WHEELS

ORD. NO.

F DA D560 03 56

Complete with 5 drawers

Dimensions mm 428x675x890 h

Partitioning material and tools excluded

RAL 7035 +
RAL 7000

■ INFO

RAL 7000 F.01 RAL 6011 F.02 RAL 5012 F.04 RAL 7035 F.08



www.famispa.com



■ The handles can be fitted towards the bottom thereby reducing the height by 38 mm.

■ Partitioning material: see page **A180**



CABINETS SERIES FLEXA



ORD. NO.	DRAWERS
F DA D550 02 04	3
Cabinet with 3 full extension drawers	
Ø 100 mm standard rubber wheels	
Cabinet load capacity: 170 kg	
Dim. mm 428x675x790 h	Central lock



ORD. NO.	DRAWERS
F DA D550 03 04	4
Cabinet with 4 full extension drawers	
Ø 100 mm standard rubber wheels	
Cabinet load capacity: 170 kg	
Dim. mm 428x675x790 h	Central lock



ORD. NO.	DRAWERS
F DA D550 04 04	5
Cabinet with 5 full extension drawers	
Ø 100 mm standard rubber wheels	
Cabinet load capacity: 170 kg	
Dim. mm 428x675x790 h	Central lock



ORD. NO.	DRAWERS
F DA D560 01 04	3
Cabinet with 3 full extension drawers	
Ø 100 mm standard rubber wheels	
Cabinet load capacity: 170 kg	
Dim. mm 428x675x890 h	Central lock



ORD. NO.	DRAWERS
F DA D560 02 04	3
Cabinet with 3 full extension drawers	
Ø 100 mm standard rubber wheels	
Cabinet load capacity: 170 kg	
Dim. mm 428x675x890 h	Central lock



ORD. NO.	DRAWERS
F DA D560 03 04	5
Cabinet with 5 full extension drawers	
Ø 100 mm standard rubber wheels	
Cabinet load capacity: 170 kg	
Dim. mm 428x675x890 h	Central lock

RAL 7000 F.01 RAL 6011 F.02 RAL 5012 F.04 RAL 7035 F.08

KEY ■



■ Partitioning material: see page A9



■ The handles can be fitted towards the bottom thereby reducing the height by 38 mm.

- T = full extension (100%)
- All indicated loads are net and refer to evenly distributed weights.



LENGTH = 428 mm DEPTH = 600 mm (19x27 Eh)

CABINETS SERIES FLEXA

EMPTY CABINETS

ORD. NO.	USABLE HEIGHT mm	LOAD CAPACITY kg	DIMENSIONS mm
F DZ 1020 00 04	200	300	428x600x300 h
F DZ 1030 00 04	300	400	428x600x400 h
F DA 1050 00 04	500	900	428x600x600 h
F DA 1060 00 04	600	900	428x600x700 h
F DA 1070 00 04	700	900	428x600x800 h
F DA 1090 00 04	900	900	428x600x1000 h

01 02 04 08



- Cabinets series F DA: central lock with anti-tilt rod.
- Cabinets series F DZ: side lock with side rod.
- Worktop load capacity: 80 kg

- The cabinets must be secured to the floor or to the wall. If the cabinets are stacked they must be secured to the wall and their load capacity must be divided by 2. Further information for fixing set see page A2.
- Drawers cannot be fitted behind doors.

DRAWERS

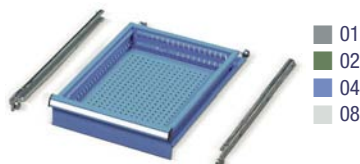

01 02 04 08

■ The single drawer opening system ORD. NO. F DD 9400 00 07 must be applied to all drawers of mobile cabinets.

ORD. NO.	FRONT HEIGHT mm	LOAD CAPACITY kg	USABLE DIMENSIONS mm
F DA 8050 00 04	50	50	323x447x36 h
F DA 8075 00 04	75	70	323x447x61 h
F DA 8100 00 04	100	70	323x447x86 h
F DA 8150 00 04	150	70	323x447x136 h
F DA 8200 00 04	200	70	323x447x186 h
F DA 8300 00 04	300	70	323x447x286 h

Full extension (100%)

SPARE LOCK AND SPARE HANDLE

ORD. NO.

R CSR 0003 00

Spare lock (for central lock)

R CSR 0032 00

Spare lock (for side lock)

R CSR 0033 00

Spare lock (for doors handle)

R XDA 0002 07

Spare handle (for doors)

- Partitioning material: see page A9

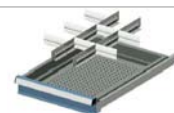

RETRACTABLE SHELVES

ORD. NO.	SIDE HEIGHT mm	LOAD CAPACITY kg	USABLE DIMENSIONS mm
F DA 8000 00 04	-	70	300x475

Full extension (100%)

ADJUSTABLE SHELVES

ORD. NO.	SIDE HEIGHT mm	LOAD CAPACITY kg	USABLE DIMENSIONS mm
F DA 9100 01 04	25	70	365x460

Without extension system

TOP

ORD. NO.	DIMENSIONS mm
F DA 9150 01 07	428x600x20 h

Rubber cover top with 3 edges

Oil-resistant rubber mat

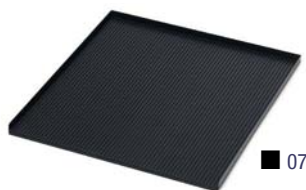

07

PAIR OF PLINTHS

ORD. NO.	HEIGHT mm
F RR 1608 00 07	130

F RR 1608 00 07

130

PARTIAL HEIGHT REVERSIBLE DOOR



- The door can be fitted both with left-hand and right-hand opening.

TOTAL HEIGHT REVERSIBLE DOOR

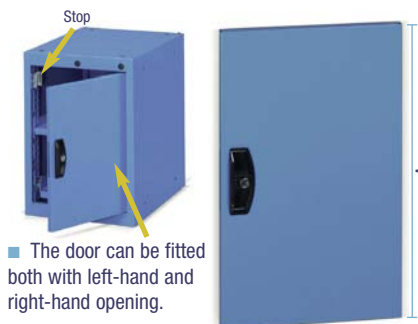

- The door can be fitted both with left-hand and right-hand opening.

01 02 04 08

- Drawers cannot be fitted behind doors

ORD. NO.	HEIGHT (A) mm
F DA 9640 02 04	400+25
F DA 9645 02 04	500+25
F DA 9650 02 04	600+25

ORD. NO.	HEIGHT (A) mm
F DA 9645 01 04	500
F DA 9650 01 04	600

CATCH

ORD. NO. F DA 9698 00 99

To order with full height doors only.



99

LENGTH = 428 mm DEPTH = 600 mm (19x27 Eh)

CABINETS SERIES FLEXA

UPPER MDF TOP WITH RUBBER COVERING DIMENSIONS 429x600x31,5 mm h

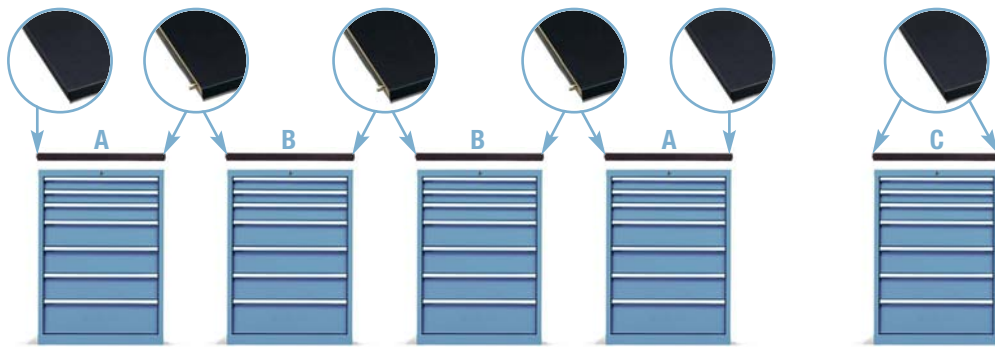

Detail of the oil-resistant rubber

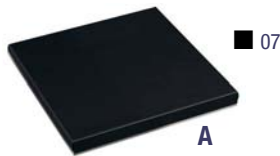

A

ORD. NO.

F UZ 3100 11 07

MDF top with rubber covering

Side profile

For end cabinets

Oil-resistant rubber mat

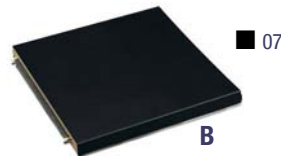

B

ORD. NO.

F UZ 3100 12 07

MDF top with rubber covering

No side profile

For additional central cabinets Oil-resist. rubber mat

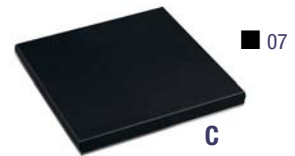

C

ORD. NO.

F UZ 3100 13 07

MDF top with rubber covering

2 side profiles

For single cabinet

Oil-resistant rubber mat

CABINET PREPARED FOR WHEELS

Cabinet prepared for wheels including: wheel plate, 4 edged top with oil-resistant rubber, 2 steel handles covered with shock-resistant rubber, cylinder lock with 2 keys, anti-tilt rod.

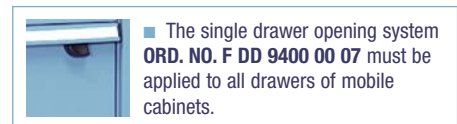
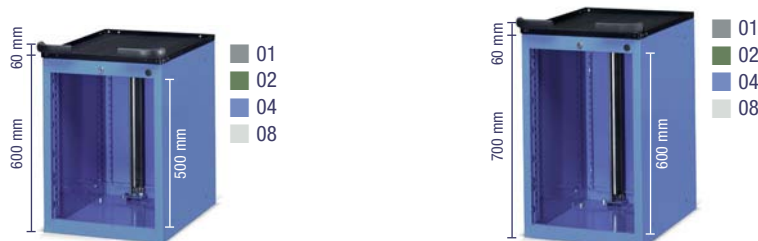

ORD. NO.

F DA 0550 00 04

Overall dim. mm 428x675x660 h without wheels

ORD. NO.

F DA 0560 00 04

Overall dim. mm 428x675x760 h without wheels

STANDARD RUBBER SWIVEL WHEEL WITH BRAKE

ORD. NO.	Ø mm	CABINET LOAD CAP.	C mm
C RG DAC11 100	100	170 kg	130
C RG DAC12 125	125	245 kg	160
C RG DAC13 150	150	290 kg	185

STANDARD RUBBER FIXED WHEEL

ORD. NO.	Ø mm	CABINET LOAD CAP.	C mm
C RG BAC11 100	100	170 kg	130
C RG BAC12 125	125	245 kg	160
C RG BAC13 150	150	290 kg	185

NYLON SWIVEL WHEEL WITH BRAKE

ORD. NO.	Ø mm	CABINET LOAD CAP.	C mm
C RN DAD10 100	100	320 kg	130
C RN DAD11 125	125	400 kg	160

NYLON FIXED WHEEL

ORD. NO.	Ø mm	CABINET LOAD CAP.	C mm
C RN BAD10 100	100	320 kg	130
C RN BAD11 125	125	400 kg	160

RAL 7000 F.01

RAL 6011 F.02

RAL 5012 F.04

RAL 7035 F.08

KEY



Other types
of wheels: see
page A52

The handles can be
fitted towards the
bottom thereby
reducing the height
by 38 mm.



All indicated loads are net and refer to evenly distributed weights.



LENGTH = 428 mm DEPTH = 600 mm (19x27 Eh)

CABINETS SERIES FLEXA

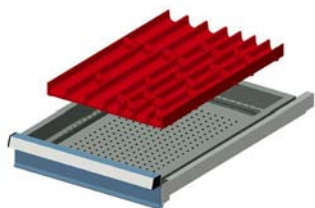

ORD. NO.	FOR FRONT HEIGHTS
----------	-------------------

F FH 8205 02 00	50-300
------------------------	--------

Set including:

3 Troughs	4 grooves
3 Troughs	3 grooves
16 Plain partitions	36 mm
7 Plain partitions	47 mm



ORD. NO.	FOR FRONT HEIGHTS
----------	-------------------

F FH 8205 03 00	50-300
------------------------	--------

Set including:

3 Troughs	3 grooves
3 Troughs	2 grooves
15 Plain partitions	47 mm
8 Plain partitions	73 mm



ORD. NO.	FOR FRONT HEIGHTS
----------	-------------------

F FH 8205 04 00	50-300
------------------------	--------

Set including:

6 Troughs	2 grooves
18 Plain partitions	73 mm

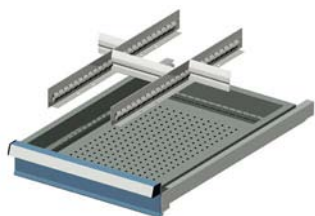

ORD. NO.	FOR FRONT HEIGHTS
----------	-------------------

F FH 8205 08 00	50
F FH 8207 08 00	75
F FH 8210 08 00	100-125

Set including:

2 Slotted partitions	455 mm
1 Plain partition	132 mm
1 Plain partition	98 mm
1 Plain partition	81 mm

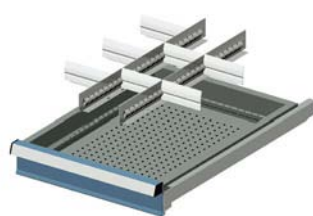

ORD. NO.	FOR FRONT HEIGHTS
----------	-------------------

F FH 8205 09 00	50
F FH 8207 09 00	75
F FH 8210 09 00	100-125
F FH 8215 09 00	150-175

Set including:

2 Slotted partitions	455 mm
3 Plain partitions	115 mm
4 Plain partitions	98 mm



ORD. NO.	FOR FRONT HEIGHTS
----------	-------------------

F FH 8405 13 00	50
F FH 8407 13 00	75
F FH 8410 13 00	100-125
F FH 8415 13 00	150-175
F FH 8420 13 00	200-250

Set including:

2 Plain partitions	455 mm
--------------------	--------

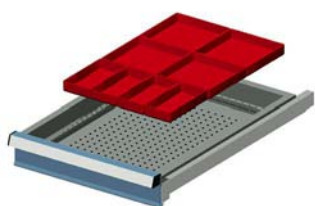

ORD. NO.	FOR FRONT HEIGHTS
----------	-------------------

F FH 8205 18 00	50
F FH 8207 18 00	75
F FH 8210 18 00	100-125

Set including:

4 Plastic boxes	150x75 mm
4 Plastic boxes	150x150 mm

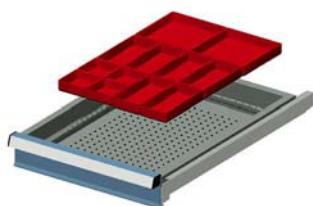

ORD. NO.	FOR FRONT HEIGHTS
----------	-------------------

F FH 8205 17 00	50
F FH 8207 17 00	75

Set including:

4 Plastic boxes	75x75 mm
6 Plastic boxes	150x75 mm
2 Plastic boxes	150x150 mm

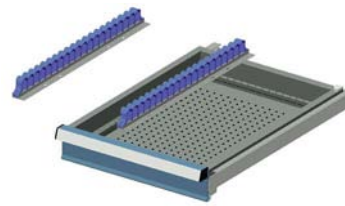

ORD. NO.	FOR FRONT HEIGHTS
----------	-------------------

F FH 8605 19 00	50-300
------------------------	--------

Set including:

2 Multi-purpose supports	440 mm
--------------------------	--------

■ INFO

www.famispa.com

■ Partitioning material: see page A180





ORD. NO. F DB B560 02 EF
RAL 7000+7035



ORD. NO. F DB 1070 58 56
RAL 7035+7000



FLOOR FIXING SET



2x

- 2 "HILTI" plugs for concrete floors \geq to classes B25/RBK250/MP_A 25 N/mm²
- Recommended traction of the plug: 2.9 KN
- Plug diameter: \varnothing 6 mm

ORD. NO. F AG 9204 00 99

CABINET WITH WHEELS

ORD. NO. _____ **DRAWERS** _____

F DB B560 02 EF **5**

Complete with 5 drawers

Dimensions mm 564x675x920 h

Partitioning material excluded

CABINET

ORD. NO. _____ **DRAWERS** _____

F DB 1070 58 56 **5**

Complete with 5 drawers, 1 electric system,
1 pneumatic system, 1 pair of plinths,
1 rubber cover top with 3 edges

Dimensions mm 564x600x930 h

RAL 7000 F.01

RAL 6011 F.02

RAL 5012 F.04

RAL 7035 F.08

SUPPLEMENTARY PARTS ■



■ Partitioning material: see page A19



■ **Spare key.** Always indicate the number on the cylinder lock of the key to be replaced.

ORD. NO. R CSC 0002 00

■ **Master key.** This type of key opens all the 45 and 46 series locks.

ORD. NO. R CSC 0001 00



LENGTH = 564 mm DEPTH = 600 mm (27x27 Eh)

CABINETS SERIES FLEXA



•ORD. NO. DRAWERS
F DC 1020 51 04 2
 Cabinet with 2 full extension drawers
 Dim. mm 564x600x300 h Side lock



•ORD. NO. DRAWERS
F DC 1020 52 04 2
 Cabinet with 2 full extension drawers
 Dim. mm 564x600x300 h Side lock



•ORD. NO. DRAWERS
F DC 1020 53 04 3
 Cabinet with 3 full extension drawers
 Dim. mm 564x600x300 h Side lock



•ORD. NO. DRAWERS
F DC 1030 51 04 2
 Cabinet with 2 full extension drawers
 Dim. mm 564x600x400 h Side lock



•ORD. NO. DRAWERS
F DC 1030 52 04 2
 Cabinet with 2 full extension drawers
 Dim. mm 564x600x400 h Side lock



•ORD. NO. DRAWERS
F DC 1030 53 04 3
 Cabinet with 3 full extension drawers
 Dim. mm 564x600x400 h Side lock



ORD. NO. DRAWERS
F DB 1050 52 04 4
 Cabinet with 4 full extension drawers
 Dim. mm 564x600x600 h Central lock



ORD. NO. DRAWERS
F DB 1050 55 04 3
 Cabinet with 3 full extension drawers,
 1 differential circuit breaker, 1 Schuko socket,
 1 CEE 220-250V socket, 1 CEE 380V socket
 Dim. mm 564x600x600 h Central lock



ORD. NO. SHELVES
F DB 1050 58 04 2
 Cabinet with 1 adjustable shelf,
 1 retractable shelf 100%
 Dimensions mm 564x600x600 h



•ORD. NO. DRAWERS
F DB 1060 51 04 4
 Cabinet with 4 full extension drawers
 Dim. mm 564x600x700 h Central lock



•ORD. NO. DRAWERS
F DB 1060 52 04 5
 Cabinet with 5 full extension drawers
 Dim. mm 564x600x700 h Central lock



•ORD. NO. DRAWERS
F DB 1060 53 04 6
 Cabinet with 6 full extension drawers
 Dim. mm 564x600x700 h Central lock

KEY



- The cabinets must be secured to the floor or to the wall.
- PE = full extension retractable shelf (100%)
- PR = height adjustable shelf
- T = full extension (100%)

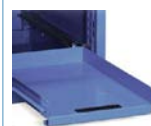

■ Detail of the full retractable shelves (PE) with load capacity of 70 kg.

■ Partitioning material: see page A19

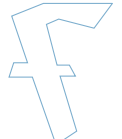

RAL 7000 F.01 RAL 6011 F.02 RAL 5012 F.04 RAL 7035 F.08

CABINETS SERIES FLEXA



ORD. NO.	DRAWERS
F DB 1070 53 04	4
Cabinet with 4 full extension drawers	
Dimensions mm 564x600x800 h	
Central lock	



ORD. NO.	DRAWERS
F DB 1070 51 04	5
Cabinet with 5 full extension drawers	
Dimensions mm 564x600x800 h	
Central lock	

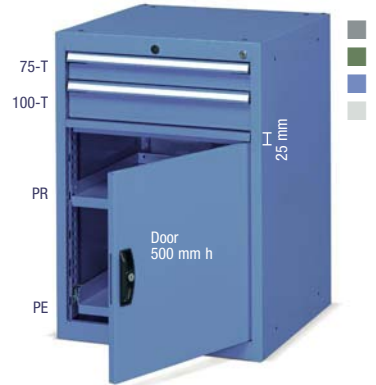

ORD. NO.	DRAWERS
F DC 1070 57 04	2
Cabinet with 2 full extension drawers, 1 adjustable shelf, 1 retractable shelf 100%	
Dim. mm 564x600x800 h	
Side lock	

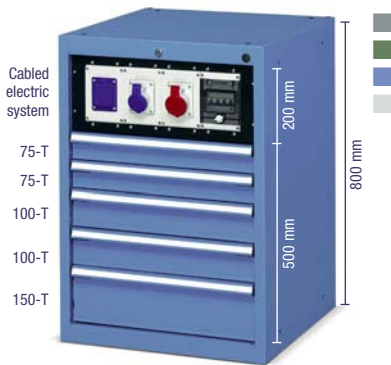

ORD. NO.	DRAWERS
F DB 1070 54 04	5
Cabinet with 5 full extension drawers	
1 differential circuit breaker	
1 Schuko socket	
1 CEE 220-250V socket	
1 CEE 380V socket	
Dimensions mm 564x600x800 h	
Central lock	



ORD. NO.	DRAWERS
F DB 1075 51 04	5
Cabinet with 5 full extension drawers	
Dimensions mm 564x600x850 h	
Central lock	



ORD. NO.	DRAWERS
F DB 1075 52 04	6
Cabinet with 6 full extension drawers	
Dimensions mm 564x600x850 h	
Central lock	

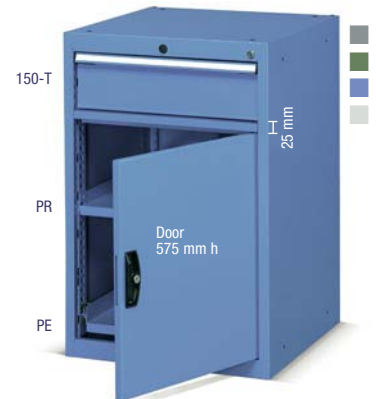

ORD. NO.	DRAWERS
F DC 1075 57 04	1
Cabinet with 1 full extension drawer, 1 adjustable shelf, 1 retractable shelf 100%	
Dimensions mm 564x600x850 h	

RAL 7000 F.01 RAL 6011 F.02 RAL 5012 F.04 RAL 7035 F.08

KEY ■

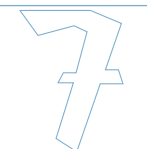

■ Partitioning material: see page A19

■ Detail of the full retractable shelves (PE) with load capacity of 70 kg.



- The cabinets must be secured to the floor or to the wall.
- PE = full extension retractable shelf (100%)
- PR = height adjustable shelf
- T = full extension (100%)



LENGTH = 564 mm DEPTH = 600 mm (27x27 Eh)

CABINETS SERIES FLEXA

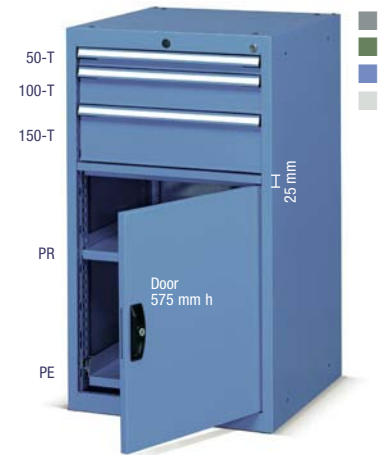
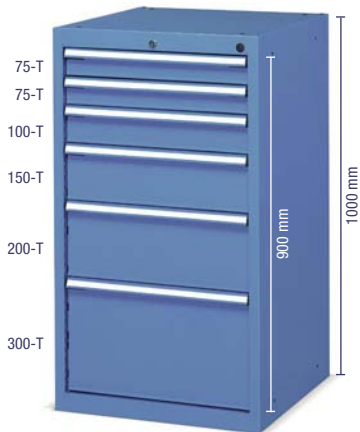

ORD. NO.	DRAWERS
F DB 1090 51 04	6
Cabinet with 6 full extension drawers	
Dimensions mm 564x600x1000 h	
Central lock	

ORD. NO.	DRAWERS
F DB 1090 52 04	7
Cabinet with 7 full extension drawers	
Dimensions mm 564x600x1000 h	
Central lock	

ORD. NO.	DRAWERS
F DC 1090 56 04	3
Cabinet with 3 full extension drawers, 1 adjustable shelf, 1 retractable shelf 100%	
Dim. mm 564x600x1000 h	
Side lock	



EXAMPLE INCLUDING:

ORD. NO.

F AB ZA06 00 08

2 cabinets with drawers, partitioning material, MDF tops with rubber covering,
1 cabinet with doors, adjustable shelves, boxes, MDF top with rubber covering

Dimensions mm 2782x600x1030 h

Tools excluded

The FLEXA cabinets can be combined to the 600 mm deep F AB series cabinets. See from page A242 for further information.

KEY



- The cabinets must be secured to the floor or to the wall.
- PE = full extension retractable shelf (100%)
- PR = height adjustable shelf
- T = full extension (100%)

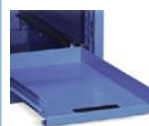

Detail of the full retractable shelves (PE) with load capacity of 70 kg.

Partitioning material: see page A19

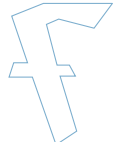

RAL 7000 F.01 RAL 6011 F.02 RAL 5012 F.04 RAL 7035 F.08

CABINETS SERIES FLEXA



ORD. NO.	DRAWERS
F DB B550 01 04	3
Cabinet with 3 full extension drawers	
Ø 125 mm standard rubber wheels	
Cabinet load capacity: 235 kg	
Dim. mm 564x675x820 h	
	Central lock



ORD. NO.	DRAWERS
F DB B550 02 04	4
Cabinet with 4 full extension drawers	
Ø 125 mm standard rubber wheels	
Cabinet load capacity: 235 kg	
Dim. mm 564x675x820 h	
	Central lock



ORD. NO.	DRAWERS
F DB B550 03 04	5
Cabinet with 5 full extension drawers	
Ø 125 mm standard rubber wheels	
Cabinet load capacity: 235 kg	
Dim. mm 564x675x820 h	
	Central lock



ORD. NO.	DRAWERS
F DB D550 01 04	3
Cabinet with 3 full extension drawers	
Ø 100 mm standard rubber wheels	
Cabinet load capacity: 160 kg	
Dimensions mm 564x675x790 h	
	Central lock



ORD. NO.	DRAWERS
F DB B560 01 04	4
Cabinet with 4 full extension drawers	
Ø 125 mm standard rubber wheels	
Cabinet load capacity: 235 kg	
Dim. mm 564x675x920 h	
	Central lock



ORD. NO.	DRAWERS
F DB B560 02 04	5
Cabinet with 5 full extension drawers	
Ø 125 mm standard rubber wheels	
Cabinet load capacity: 235 kg	
Dim. mm 564x675x920 h	
	Central lock



ORD. NO.	DRAWERS
F DB B560 03 04	6
Cabinet with 6 full extension drawers	
Ø 125 mm standard rubber wheels	
Cabinet load capacity: 235 kg	
Dim. mm 564x675x920 h	
	Central lock

RAL 7000 F.01 RAL 6011 F.02 RAL 5012 F.04 RAL 7035 F.08

KEY ■



■ Partitioning material: see page A19

■ The handles can be fitted towards the bottom thereby reducing the height by 38 mm.



- T = full extension (100%)
- All indicated loads are net and refer to evenly distributed weights.



LENGTH = 564 mm DEPTH = 600 mm (27x27 Eh)

CABINETS SERIES FLEXA



ORD. NO.	DRAWERS
F DB D560 01 04	4
Cabinet with 4 full extension drawers	
Ø 100 mm standard rubber wheels	
Cabinet load capacity: 160 kg	
Dim. mm 564x675x890 h	Central lock



ORD. NO.	DRAWERS
F DB B570 01 04	5
Cabinet with 5 full extension drawers	
Ø 125 mm standard rubber wheels	
Cabinet load capacity: 235 kg	
Dim. mm 564x675x1020 h	Central lock



ORD. NO.	DRAWERS
F DB B575 01 04	5
Cabinet with 5 full extension drawers	
Ø 125 mm standard rubber wheels	
Cabinet load capacity: 235 kg	
Dim. mm 564x675x1070 h	Central lock



ORD. NO.	DRAWERS
F DB B590 01 04	6
Cabinet with 6 full extension drawers	
Ø 125 mm standard rubber wheels	
Cabinet load capacity: 235 kg	
Dim. mm 564x675x1220 h	Central lock



ORD. NO.	DRAWERS
F DB B590 02 04	7
Cabinet with 7 full extension drawers	
Ø 125 mm standard rubber wheels	
Cabinet load capacity: 235 kg	
Dim. mm 564x675x1220 h	Central lock



ORD. NO.	DRAWERS
F DB B590 03 04	8
Cabinet with 8 full extension drawers	
Ø 125 mm standard rubber wheels	
Cabinet load capacity: 235 kg	
Dim. mm 564x675x1220 h	Central lock

KEY

RAL 7000 F.01 RAL 6011 F.02 RAL 5012 F.04 RAL 7035 F.08



- T = full extension (100%)
- All indicated loads are net and refer to evenly distributed weights.
- The cabinets must be secured to the floor or to the wall.
- Drawers cannot be fitted behind doors.



- The handles can be fitted towards the bottom thereby reducing the height by 38 mm.

- Partitioning material: see page A19

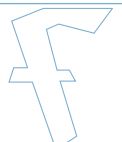

LENGTH = 564 mm DEPTH = 600 mm (27x27 Eh)

CABINETS SERIES FLEXA

EMPTY CABINETS

ORD. NO.	USABLE HEIGHT mm	LOAD CAPACITY kg	DIMENSIONS mm
F DC 1020 00 04	200	300	564x600x300 h
F DC 1030 00 04	300	400	564x600x400 h
F DB 1050 00 04	500	900	564x600x600 h
F DB 1060 00 04	600	900	564x600x700 h
F DB 1070 00 04	700	900	564x600x800 h
F DB 1075 00 04	750	900	564x600x850 h
F DB 1090 00 04	900	900	564x600x1000 h

■ 01 ■ 02 ■ 04 ■ 08



- Cabinets series F DB: central lock with anti-tilt rod.
- Cabinets series F DC: side lock with side rod.
- Worktop load capacity: 80 kg

■ The cabinets must be secured to the floor or to the wall. If the cabinets are stacked they must be secured to the wall and their load capacity must be divided by 2. Further information for fixing set see page A10.

- Drawers cannot be fitted behind doors.

DRAWERS

■ 01
■ 02
■ 04
■ 08

- The single drawer opening system ORD. NO. F DD 9400 00 07 must be applied to all drawers of mobile cabinets.

ORD. NO.	FRONT HEIGHT mm	LOAD CAPACITY kg	USABLE DIMENSIONS mm
F DB 8050 00 04	50	50	447x447x36 h
F DB 8075 00 04	75	70	447x447x61 h
F DB 8100 00 04	100	70	447x447x86 h
F DB 8125 00 04	125	70	447x447x111 h
F DB 8150 00 04	150	70	447x447x136 h
F DB 8200 00 04	200	70	447x447x186 h
F DB 8250 00 04	250	70	447x447x236 h
F DB 8300 00 04	300	70	447x447x286 h

Full extension (100%)

SPARE LOCK AND SPARE HANDLE

ORD. NO.

R CSR 0003 00
Spare lock (for central lock)R CSR 0032 00
Spare lock (for side lock)R CSR 0033 00
Spare lock (for doors handle)R XDA 0002 07
Spare handle (for doors)

- Partitioning material: see page A19

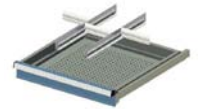

RETRACTABLE SHELVES

ORD. NO.	SIDE HEIGHT mm	LOAD CAPACITY kg	USABLE DIMENSIONS mm
F DB 8000 00 04	–	70	435x475

Full extension (100%)

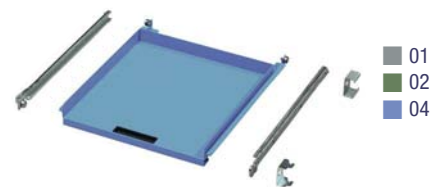
■ 01
■ 02
■ 04

ADJUSTABLE SHELVES

ORD. NO.	SIDE HEIGHT mm	LOAD CAPACITY kg	USABLE DIMENSIONS mm
F DB 9100 01 04	25	70	505x460

Without extension system

■ 01
■ 02
■ 04

TOP

ORD. NO.	DIMENSIONS mm
F DB 9150 01 07	564x600x20 h

Rubber cover top with 3 edges

Oil-resistant rubber mat

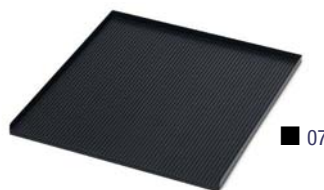

■ 07

PAIR OF PLINTHS

ORD. NO.	HEIGHT mm
F RR 1608 00 07	130



■ 07

RAL 7000 F.01 RAL 6011 F.02 RAL 5012 F.04 RAL 7035 F.08

KEY ■

- All indicated loads are net and refer to evenly distributed weights.



LENGTH = 564 mm DEPTH = 600 mm (27x27 Eh)

CABINETS SERIES FLEXA

PARTIAL HEIGHT REVERSIBLE DOOR



■ The door can be fitted both with left-hand and right-hand opening.

TOTAL HEIGHT REVERSIBLE DOOR



■ The door can be fitted both with left-hand and right-hand opening.

ORD. NO.

HEIGHT (A) mm

F DB 9640 02 04	400+25
F DB 9642 02 04	425+25
F DB 9645 02 04	500+25
F DB 9649 02 04	575+25
F DB 9650 02 04	600+25

ORD. NO.

HEIGHT (A) mm

F DB 9645 01 04	500
F DB 9650 01 04	600

■ Drawers cannot be fitted behind doors

CATCH

ORD. NO. F DA 9698 00 99

To order with full height doors only.



■ 99



■ RAL 7000

EXAMPLE INCLUDING:

ORD. NO.

F DB ZA01 00 01

2 cabinets with drawers, door, retractable shelf, adjustable shelf, MDF top with rubber covering, plinths

Dimensioni mm 1130x600x860 h

Tools and partitioning material excluded

■ INFO

RAL 7000 F.01

RAL 6011 F.02

RAL 5012 F.04

RAL 7035 F.08

■ Partitioning material: see page A180



www.famispa.com



CABINETS SERIES FLEXA

UPPER MDF TOP WITH RUBBER COVERING DIMENSIONS 565x600x31,5 mm H

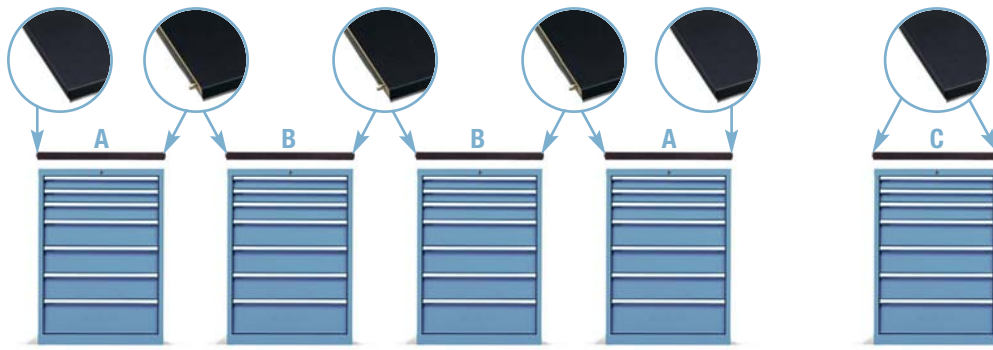

Detail of the oil-resistant rubber



07

A

ORD. NO.

F UZ 3120 11 07

MDF top with rubber covering

Side profile

For end cabinets

Oil-resistant rubber mat



07

B

ORD. NO.

F UZ 3120 12 07

MDF top with rubber covering

No side profile

For additional central cabinets Oil-resist. rubber mat



07

C

ORD. NO.

F UZ 3120 13 07

MDF top with rubber covering

2 side profiles

For single cabinet

Oil-resistant rubber mat

CABINET PREPARED FOR WHEELS

Cabinet prepared for wheels including: wheel plate, 4 edged top with oil-resistant rubber, 2 steel handles covered with shock-resistant rubber, cylinder lock with 2 keys, anti-tilt rod.



The single drawer opening system ORD. NO. F DD 9400 00 07 must be applied to all drawers of mobile cabinets.

01 02 04 08

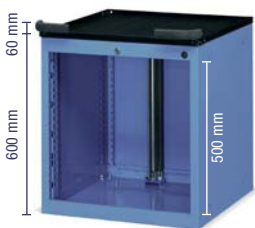

ORD. NO.

F DB 0550 00 04

Overall dimensions mm:
564x675x660 h
without wheels

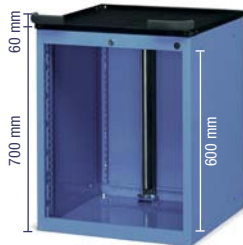

ORD. NO.

F DB 0560 00 04

Overall dimensions mm:
564x675x760 h
without wheels



ORD. NO.

F DB 0570 00 04

Overall dimensions mm:
564x675x860 h
without wheels



ORD. NO.

F DB 0575 00 04

Overall dimensions mm:
564x675x910 h
without wheels

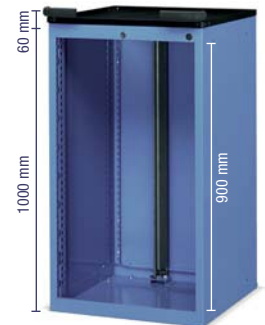

ORD. NO.

F DB 0590 00 04

Overall dimensions mm:
564x675x1060 h
without wheels



STANDARD RUBBER SWIVEL WHEEL WITH BRAKE

ORD. NO.	Ø mm	CABINET LOAD CAPACITY	C mm
C RG DAC11 100	100	160 kg	130
C RG DAC12 125	125	235 kg	160
C RG DAC13 150	150	280 kg	185



STANDARD RUBBER FIXED WHEEL

ORD. NO.	Ø mm	CABINET LOAD CAPACITY	C mm
C RG BAC11 100	100	160 kg	130
C RG BAC12 125	125	235 kg	160
C RG BAC13 150	150	280 kg	185



NYLON SWIVEL WHEEL WITH BRAKE

ORD. NO.	Ø mm	CABINET LOAD CAPACITY	C mm
C RN DAD10 100	100	310 kg	130
C RN DAD11 125	125	400 kg	160



NYLON FIXED WHEEL

ORD. NO.	Ø mm	CABINET LOAD CAPACITY	C mm
C RN BAD10 100	100	310 kg	130
C RN BAD11 125	125	400 kg	160

RAL 7000 F.01 RAL 6011 F.02 RAL 5012 F.04 RAL 7035 F.08

KEY

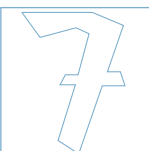

Other types of wheels: see page A52

The handles can be fitted towards the bottom thereby reducing the height by 38 mm.



All indicated loads are net and refer to evenly distributed weights.



LENGTH = 564 mm DEPTH = 600 mm (27x27 Eh)

CABINETS SERIES FLEXA

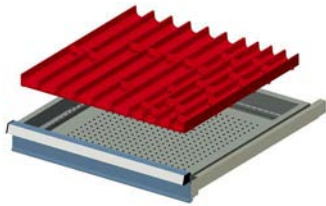

ORD. NO.	FOR FRONT HEIGHTS
----------	-------------------

F FH 8405 02 00	50-300
Set including:	
3 Troughs	4 grooves
6 Troughs	3 grooves
16 Plain partitions	36 mm
7 Plain partitions	47 mm

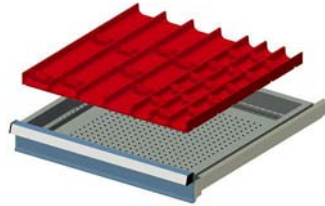

ORD. NO.	FOR FRONT HEIGHTS
----------	-------------------

F FH 8405 03 00	50-300
Set including:	
3 Troughs	3 grooves
6 Troughs	2 grooves
15 Plain partitions	47 mm
8 Plain partitions	73 mm

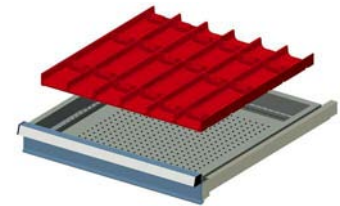

ORD. NO.	FOR FRONT HEIGHTS
----------	-------------------

F FH 8405 04 00	50-300
Set including:	
9 Troughs	2 grooves
18 Plain partitions	73 mm

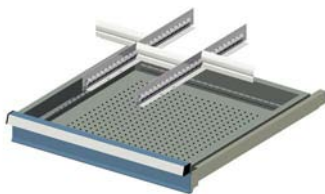

ORD. NO.	FOR FRONT HEIGHTS
----------	-------------------

F FH 8405 08 00	50
F FH 8407 08 00	75
F FH 8410 08 00	100-125
F FH 8415 08 00	150-175
F FH 8420 08 00	200-250
F FH 8430 08 00	300
Set including:	
2 Slotted partitions	455 mm
3 Plain partitions	149 mm

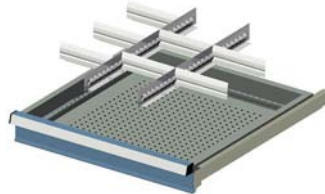

ORD. NO.	FOR FRONT HEIGHTS
----------	-------------------

F FH 8405 09 00	50
F FH 8407 09 00	75
F FH 8410 09 00	100-125
F FH 8415 09 00	150-175
F FH 8420 09 00	200-250
Set including:	
2 Slotted partitions	455 mm
7 Plain partitions	149 mm

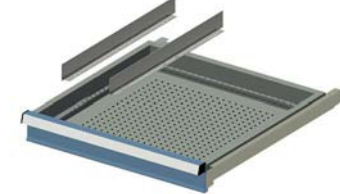

ORD. NO.	FOR FRONT HEIGHTS
----------	-------------------

F FH 8405 13 00	50
F FH 8407 13 00	75
F FH 8410 13 00	100-125
F FH 8415 13 00	150-175
F FH 8420 13 00	200-250
Set including:	
2 Plain partitions	455 mm

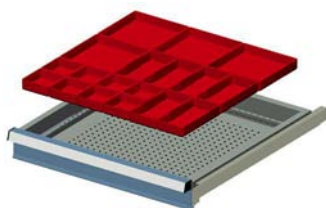

ORD. NO.	FOR FRONT HEIGHTS
----------	-------------------

F FH 8405 17 00	50
F FH 8407 17 00	75
Set including:	
8 Plastic boxes	75x75 mm
6 Plastic boxes	150x75 mm
4 Plastic boxes	150x150 mm

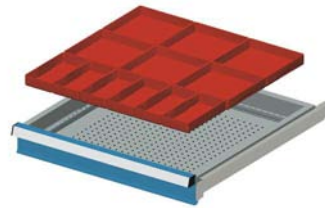

ORD. NO.	FOR FRONT HEIGHTS
----------	-------------------

F FH 8405 18 00	50
F FH 8407 18 00	75
F FH 8410 18 00	100-125
Set including:	
6 Plastic boxes	150x75 mm
6 Plastic boxes	150x150 mm

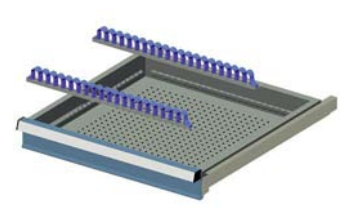

ORD. NO.	FOR FRONT HEIGHTS
----------	-------------------

F FH 8605 19 00	50-300
Set including:	
2 Multi-purpose supports	440 mm

■ INFO



www.famispa.com

■ Partitioning material: see page A180

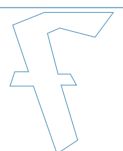

CABINETS SERIES FLEXA



ORD. NO. F DF B560 05 56
RAL 7035+7000

ORD. NO. F DF 1090 61 08
RAL 7035

36 EH (600 mm)



27 EH (447 mm)

FIXING SET



2x

- 2 "HILTI" plugs for concrete floors \geq to classes B25/RBK250/MP_A 25 N/mm²
- Recommended traction of the plug: 2.9 KN
- Plug diameter: \varnothing 6 mm

ORD. NO. F AG 9204 00 99

CABINET WITH WHEELS

ORD. NO. _____ **DRAWERS** _____

F DF B560 05 56 **3**

Complete with 3 drawers,
1 adjustable shelf, 1 flap door

Dimensions mm 792x600x920 h

Boxes, tools and partitioning material excluded

CABINET

ORD. NO. _____ **DRAWERS** _____

F DF 1090 61 08 **4**

Complete with 4 drawers, 1 electric system,
1 pneumatic system, 1 flap door,
1 rubber cover top with 4 edges

Dimensioni mm 717x600x1000 h

RAL 7000 F.01

RAL 6011 F.02

RAL 5012 F.04

RAL 7035 F.08

SUPPLEMENTARY PARTS ■



- Partitioning material: see page A29



- **Spare key.** Always indicate the number on the cylinder lock of the key to be replaced.

ORD. NO. R CSC 0002 00

- **Master key.** This type of key opens all the 45 and 46 series locks.

ORD. NO. R CSC 0001 00



LENGTH = 717 mm DEPTH = 600 mm (36x27 Eh)

CABINETS SERIES FLEXA

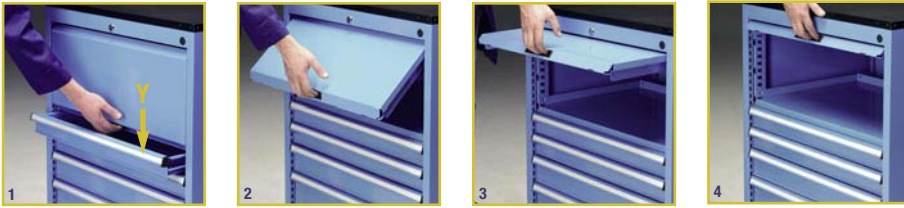

The door can be closed by the edge of the lower drawer handle (ref. Y)



ORD. NO. DRAWERS
F DG 1030 51 04 2
 Cabinet with 2 full extension drawers
 Dim. mm 717x600x400 h Side lock



ORD. NO. DRAWERS
F DG 1030 52 04 2
 Cabinet with 2 full extension drawers
 Dim. mm 717x600x400 h Side lock



ORD. NO. DRAWERS
F DG 1030 53 04 3
 Cabinet with 3 full extension drawers
 Dim. mm 717x600x400 h Side lock



ORD. NO. DRAWERS
F DF 1050 52 04 4
 Cabinet with 4 full extension drawers
 Dim. mm 717x600x600 h Central lock



ORD. NO. DRAWERS
F DF 1050 56 04 3
 Cabinet with 3 full extension drawers,
 1 differential circuit breaker, 2 Schuko sockets
 1 CEE 220-250V socket, 1 CEE 380V socket
 1 pneumatic system with 2 outlets (excl. quick connectors)
 Dim. mm 717x600x600 h Central lock

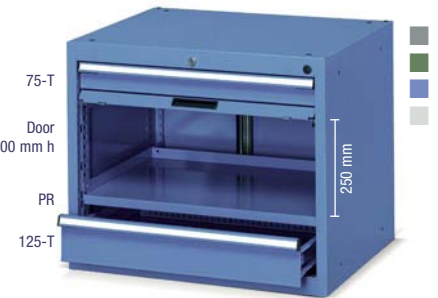

ORD. NO. DRAWERS
F DF 1050 57 04 2
 Cabinet with 2 full extension drawers,
 1 adjustable shelf, 1 flap door
 Dimensions mm 717x600x600 h Central lock



ORD. NO. DRAWERS
F DF 1060 51 04 4
 Cabinet with 4 full extension drawers
 Dim. mm 717x600x700 h Central lock



ORD. NO. DRAWERS
F DF 1060 54 04 3
 Cabinet with 3 full extension drawers,
 1 adjustable shelf, 1 flap door
 Dim. mm 717x600x700 h Central lock



ORD. NO. SHELVES
F DF 1060 57 04 2
 Cabinet with 1 adjustable shelf,
 1 retractable shelf 100%
 Dimensions mm 717x600x700 h

KEY



- The cabinets must be secured to the floor or to the wall.
- PE = full extension retractable shelf (100%)
- PR = height adjustable shelf
- T = full extension (100%)

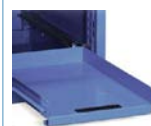

Detail of the full retractable shelves (PE) with load capacity of 70 kg.

Partitioning material: see page A29

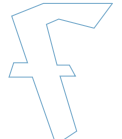

RAL 7000 F.01 RAL 6011 F.02 RAL 5012 F.04 RAL 7035 F.08

CABINETS SERIES FLEXA



ORD. NO.	DRAWERS
F DF 1070 52 04	5
Cabinet with 5 full extension drawers	
Dimensions mm 717x600x800 h	
Central lock	



ORD. NO.	DRAWERS
F DF 1070 54 04	4
Cabinet with 4 full extension drawers, 1 adjustable shelf, 1 flap door	
Dimensions mm 717x600x800 h	
Central lock	

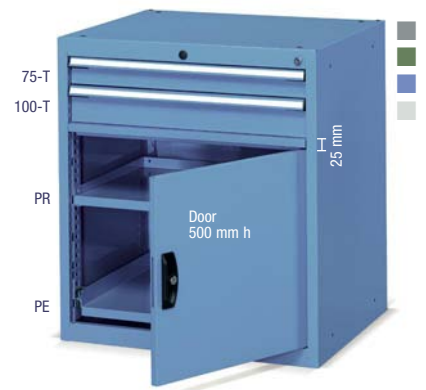

ORD. NO.	DRAWERS
F DG 1070 57 04	2
Cabinet with 2 full extension drawers 1 adjustable shelf, 1 retractable shelf 100%	
Dimensions mm 717x600x800 h	
Side lock	



ORD. NO.	DRAWERS
F DF 1070 59 04	5
Cabinet with 5 full extension drawers	
1 differential circuit breaker	
2 Schuko sockets	
1 CEE 220-250V socket	
1 CEE 380V socket	
1 pneumatic system with 2 outlets (excluding quick connectors)	
Dimensions mm 717x600x800 h	
Central lock	



ORD. NO.	DRAWERS
F DF 1075 53 04	6
Cabinet with 6 full extension drawers	
Dimensions mm 717x600x850 h	
Central lock	



ORD. NO.	DRAWERS
F DF 1075 55 04	4
Cabinet with 4 full extension drawers, 1 adjustable shelf, 1 flap door	
Dimensions mm 717x600x850 h	
Central lock	

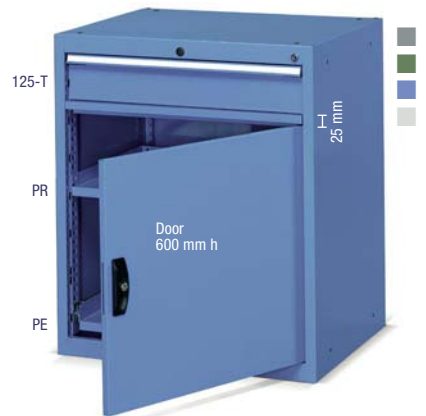

ORD. NO.	DRAWERS
F DG 1075 57 04	1
Cabinet with 1 full extension drawer 1 adjustable shelf, 1 retractable shelf 100%	
Dimensions mm 717x600x850 h	
Side lock	

RAL 7000 F.01 RAL 6011 F.02 RAL 5012 F.04 RAL 7035 F.08

KEY



■ Partitioning material: see page A29

■ Detail of the full retractable shelves (PE) with load capacity of 70 kg.

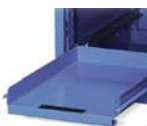

- The cabinets must be secured to the floor or to the wall.
- PE = full extension retractable shelf (100%)
- PR = height adjustable shelf
- T = full extension (100%)



LENGTH = 717 mm DEPTH = 600 mm (36x27 Eh)

CABINETS SERIES FLEXA



ORD. NO. DRAWERS
F DF 1090 52 04 6
 Cabinet with 6 full extension drawers
 Dim. mm 717x600x1000 h Central lock



ORD. NO. DRAWERS
F DF 1090 54 04 7
 Cabinet with 7 full extension drawers
 Dim. mm 717x600x1000 h Central lock



ORD. NO. DRAWERS
F DF 1090 55 04 8
 Cabinet with 8 full extension drawers
 Dim. mm 717x600x1000 h Central lock



ORD. NO. DRAWERS
F DF 1090 56 04 9
 Cabinet with 9 full extension drawers
 Dimensions mm 717x600x1000 h
 Central lock

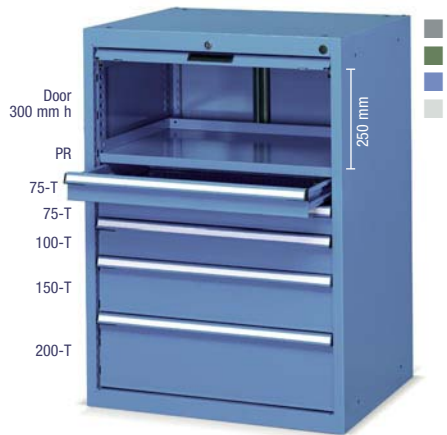

ORD. NO. DRAWERS
F DF 1090 57 04 5
 Cabinet with 5 full extension drawers,
 1 adjustable shelf, 1 flap door
 Dim. mm 717x600x1000 h Central lock

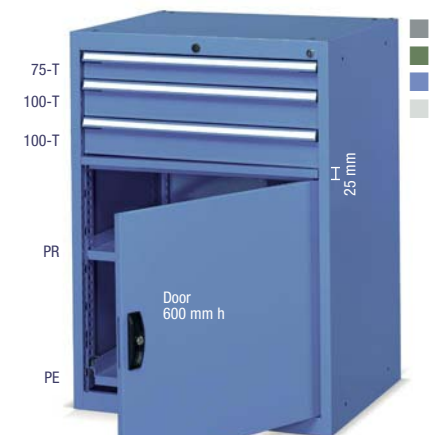

ORD. NO. DRAWERS
F DG 1090 59 04 3
 Cabinet with 3 full extension drawers
 1 adjustable shelf, 1 retractable shelf 100%
 Dim. mm 717x600x1000 h Side lock



ORD. NO. DRAWERS
F DF D550 01 04 4
 Cabinet with 4 full extension drawers
 Ø 100 mm standard rubber wheels
 Cabinet load capacity: 100 kg
 Dim. mm 792x600x790 h Central lock



ORD. NO. DRAWERS
F DF B550 02 04 5
 Cabinet with 5 full extension drawers
 Ø 125 mm standard rubber wheels
 Cabinet load capacity: 225 kg
 Dim. mm 792x600x820 h Central lock



ORD. NO. DRAWERS
F DF B550 04 04 2
 Cabinet with 2 full extension drawers
 Ø 125 mm standard rubber wheels
 1 flap door, 1 adjustable shelf
 Cabinet load capacity: 225 kg
 Dim. mm 792x600x820 h Central lock

KEY



- The cabinets must be secured to the floor or to the wall.
- PE = full extension retractable shelf (100%)
- PR = height adjustable shelf
- T = full extension (100%)
- All indicated loads are net and refer to evenly distributed weights.



■ The handles can be fitted towards the bottom thereby reducing the height by 38 mm.

■ Partitioning material: see page A29



RAL 7000 F... ..01 RAL 6011 F... ..02 RAL 5012 F... ..04 RAL 7035 F... ..08

CABINETS SERIES FLEXA



ORD. NO.	DRAWERS
F DF D560 02 04	5
Cabinet with 5 full extension drawers	
Ø 100 mm standard rubber wheels	
Cabinet load capacity: 100 kg	
Dimensions mm 792x600x890 h	
Central lock	



ORD. NO.	DRAWERS
F DF B560 02 04	5
Cabinet with 5 full extension drawers	
Ø 125 mm standard rubber wheels	
Cabinet load capacity: 225 kg	
Dimensions mm 792x600x920 h	
Central lock	



ORD. NO.	DRAWERS
F DF B560 05 04	3
Cabinet with 3 full extension drawers	
Ø 125 mm standard rubber wheels	
1 flap door, 1 adjustable shelf	
Cabinet load capacity: 225 kg	
Dim. mm 792x600x920 h	Central lock



ORD. NO.	DRAWERS
F DF B560 06 04	2
Cabinet with 2 full extension drawers, 1 differential circuit breaker, 1 Schuko socket, 1 electric rear winder 220V for the connection to the electric main supply, 1 pneumatic system with 1 3/8" fixed frontal outlet (excluding quick connection), 1 frontal pneumatic winder with hose Ø 5,5 mm and connector of 1/4", 1 rear pneumatic winder with hose Ø 10 mm and connector of 3/8" for the connection to the pneumatic system.	
Ø 125 mm standard rubber wheels, cabinet load capacity: 225 kg	
Dimensions mm 792x600x920 h	Central lock



Usable power:
 1200 Watt with wound cable,
 1800 Watt with cable completely unwound.

Rear 11 metres long pneumatic extension.
 Rear 10 metres long electric extension.



ORD. NO.	DRAWERS
F DF B561 01 04	5
Cabinet with 5 full extension drawers, 4 practibox drawer unit ORD. NO. F PG 2071 01 01	
Ø 125 mm standard rubber wheels	
Cabinet load capacity: 225 kg	
Dimensions mm 1072x600x885 h	
Multiplex worktop dim. mm 860x600x25 h	
Central lock	



ORD. NO.	DRAWERS
F DF B570 02 04	6
Cabinet with 6 full extension drawers	
Ø 125 mm standard rubber wheels	
Cabinet load capacity: 225 kg	
Dimensions mm 792x600x1020 h	
Central lock	



ORD. NO.	DRAWERS
F DF B570 04 04	4
Cabinet with 4 full extension drawers, 1 flap door, 1 adjustable shelf	
Ø 125 mm standard rubber wheels	
Cabinet load capacity: 225 kg	
Dim. mm 792x600x1020 h	Central lock

RAL 7000 F.....01 RAL 6011 F.....02 RAL 5012 F.....04 RAL 7035 F.....08

KEY

- PR = height adjustable shelf
- T = full extension (100%)
- All indicated loads are net and refer to evenly distributed weights.

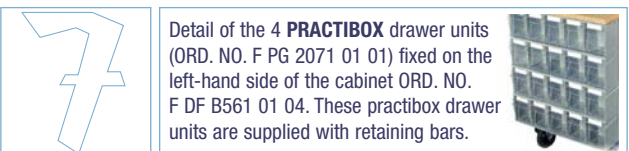

LENGTH = 717 mm DEPTH = 600 mm (36x27 Eh)

CABINETS SERIES FLEXA

CABINET WITH WHEELS**ORD. NO.****F DF B570 S1 FN**

Complete with 4 drawers

1 adjustable shelf

1 flap door

Dimensions mm 794x600x982 h

Boxes, tools and partitioning material excluded



■ RAL 3020 +
■ RAL 9011

EXAMPLE INCLUDING:**ORD. NO.****F DF 1070 61 08**

Cabinet complete with 1 drawer

1 door

1 retractable shelf

1 electric system

1 pneumatic system

1 pair of plinths

1 covering MDF top with rubber

Dimensions mm 717x600x960 h

Tools and partitioning material excluded



■ RAL 7035

■ INFO

RAL 7000 F.01

RAL 6011 F.02

RAL 5012 F.04

RAL 7035 F.08

■ Partitioning material: see page A180

www.famispa.com

CABINETS SERIES FLEXA

EMPTY CABINETS

ORD. NO.	USABLE HEIGHT mm	LOAD CAPACITY kg	DIMENSIONS mm
F DG 1030 00 04	300	400	717x600x400 h
F DF 1050 00 04	500	900	717x600x600 h
F DF 1060 00 04	600	900	717x600x700 h
F DF 1070 00 04	700	900	717x600x800 h
F DF 1075 00 04	750	900	717x600x850 h
F DF 1090 00 04	900	900	717x600x1000 h

■ 01 ■ 02 ■ 04 ■ 08



- Cabinets series F DF: central lock with anti-tilt rod.
- Cabinets series F DG: side lock with side rod.
- Worktop load capacity: 80 kg

■ The cabinets must be secured to the floor or to the wall. If the cabinets are stacked they must be secured to the wall and their load capacity must be divided by 2. Further information for fixing set see page A20.

■ Drawers cannot be fitted behind doors.

DRAWERS



■ 01 ■ 02 ■ 04 ■ 08

■ The single drawer opening system ORD. NO. F DD 9400 00 07 must be applied to all drawers of mobile cabinets.

ORD. NO.	FRONT HEIGHT mm	LOAD CAPACITY kg	USABLE DIMENSIONS mm
F DF 8075 00 04	75	70	600x447x61 h
F DF 8100 00 04	100	70	600x447x86 h
F DF 8125 00 04	125	70	600x447x111 h
F DF 8150 00 04	150	70	600x447x136 h
F DF 8175 00 04	175	70	600x447x161 h
F DF 8200 00 04	200	70	600x447x186 h
F DF 8300 00 04	300	70	600x447x286 h

Full extension (100%)

SPARE LOCK AND SPARE HANDLE

ORD. NO.
R CSR 0003 00
Spare lock (for central lock)
R CSR 0032 00
Spare lock (for side lock)
R CSR 0033 00
Spare lock (for doors handle)
R XDA 0002 07
Spare handle (for doors)

■ Partitioning material: see page A29

RETRACTABLE SHELVES

ORD. NO.	USABLE DIMENSIONS mm
F DF 8000 00 04	587x475

Side height: -
Load capacity kg: 70 Full extension (100%)



■ 01 ■ 02 ■ 04

ADJUSTABLE SHELVES

ORD. NO.	USABLE DIMENSIONS mm
F DF 9100 01 04	655x460

Side height: 25 mm
Load capacity kg: 70 Without extension system

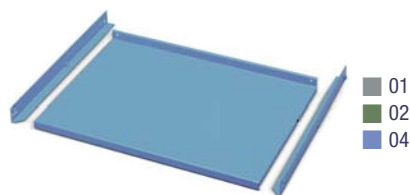

■ 01 ■ 02 ■ 04



PAIR OF PLINTHS	HEIGHT mm
ORD. NO. F RR 1608 00 07	130

TOP WITH 4 EDGES

ORD. NO.	DIMENSIONS mm
F DF 9940 01 07	717x600x22 h

Top with 4 edges in rubber
Oil-resistant rubber mat

PARTIAL HEIGHT REVERSIBLE DOOR



■ The door can be fitted both with left-hand and right-hand opening.

TOTAL HEIGHT REVERSIBLE DOOR



■ The door can be fitted both with left-hand and right-hand opening.

■ 01 ■ 02 ■ 04 ■ 08

■ Drawers cannot be fitted behind doors

ORD. NO.	HEIGHT (A) mm
F DF 9640 02 04	400+25
F DF 9645 02 04	500+25
F DF 9650 02 04	600+25

ORD. NO.	HEIGHT (A) mm
F DF 9645 01 04	500
F DF 9650 01 04	600



LENGTH = 717 mm DEPTH = 600 mm (36x27 Eh)

CABINETS SERIES FLEXA

UPPER MDF TOP WITH RUBBER COVERING DIMENSIONS 718x600x31,5 mm H

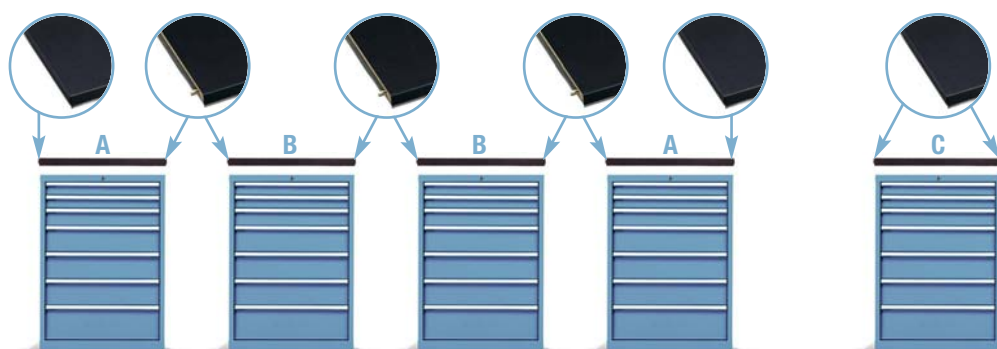

Detail of the oil-resistant rubber

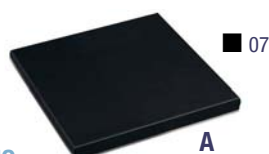
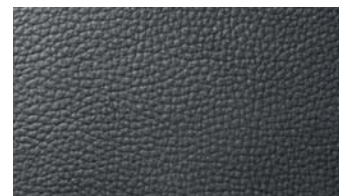

A

ORD. NO.

F UZ 3130 11 07

MDF top with rubber covering

Side profile

For end cabinets

Oil-resistant rubber mat

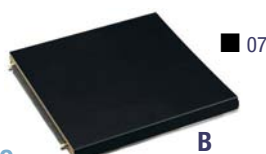

B

ORD. NO.

F UZ 3130 12 07

MDF top with rubber covering

No side profile

For additional central cabinets

Oil-resist. rubber mat



C

ORD. NO.

F UZ 3130 13 07

MDF top with rubber covering

2 side profiles

For single cabinet

Oil-resistant rubber mat

CABINET PREPARED FOR WHEELS

Cabinet prepared for wheels including: wheel plate, 4 edged top with oil-resistant rubber, 2 steel handles covered with shock-resistant rubber, cylinder lock with 2 keys, anti-tilt rod.



The single drawer opening system **ORD. NO. F DD 9400 00 07** must be applied to all drawers of mobile cabinets.



Detail of the 4 edged top with side handle. Further information see catalogue **no. 400**.

01 02 04 08

Complete of 4 Practibox drawer units **ORD. NO. F PG 2071 01 01**, multiplex worktop and side handle.



ORD. NO.

F DF 0550 00 04

Overall dimensions mm:

792x600x660 h without wheels



ORD. NO.

F DF 0560 00 04

Overall dimensions mm:

792x600x760 h without wheels



ORD. NO.

F DF 0561 00 04

Overall dimensions mm:

1072x600x725 h without wheels

Multiplex worktop dim. mm: **860x600x25 h**



ORD. NO.

F DF 0570 00 04

Overall dimensions mm:

792x600x860 h without wheels



STANDARD RUBBER SWIVEL WHEEL WITH BRAKE

ORD. NO.

Ø mm CABINET LOAD CAPACITY C mm

C RG DAC11 100 100 150 kg 130

C RG DAC12 125 125 225 kg 160

C RG DAC13 150 150 270 kg 185



NYLON SWIVEL WHEEL WITH BRAKE

ORD. NO.

Ø mm CABINET LOAD CAPACITY C mm

C RN DAD10 100 100 270 kg 130

C RN DAD11 125 125 270 kg 160



STANDARD RUBBER FIXED WHEEL

ORD. NO.

Ø mm CABINET LOAD CAPACITY C mm

C RG BAC11 100 100 150 kg 130

C RG BAC12 125 125 225 kg 160

C RG BAC13 150 150 270 kg 185



NYLON FIXED WHEEL

ORD. NO.

Ø mm CABINET LOAD CAPACITY C mm

C RN BAD10 100 100 270 kg 130

C RN BAD11 125 125 270 kg 160

KEY

RAL 7000 F.01 RAL 6011 F.02 RAL 5012 F.04 RAL 7035 F.08



All indicated loads are net and refer to evenly distributed weights.



The handles can be fitted towards the bottom thereby reducing the height by 38 mm.

Other types of wheels: see page **A52**



CABINETS SERIES FLEXA

FLAP DOOR

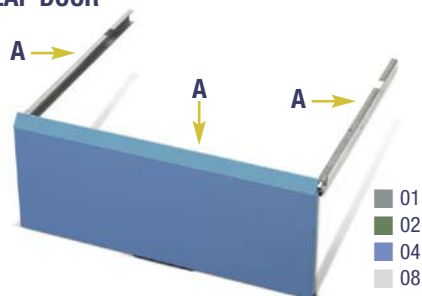

ORD. NO.	REFERENCE
F DF 9615 00 04	A+(Cx2)

Flap door with 2 guides and 2 brackets to block the door with the lower drawer locked.

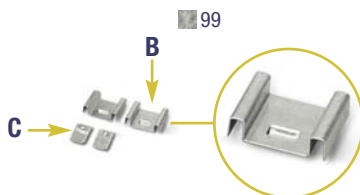

ORD. NO.	REFERENCE
F DA 9698 00 99	B

The order number includes just 1 piece. 2 pieces are needed for each door.



■ The two stops (ref. B) must be used when the door is fitted along with the drawer (ref. Z). See photo ref. 5 to understand the usable internal volume.

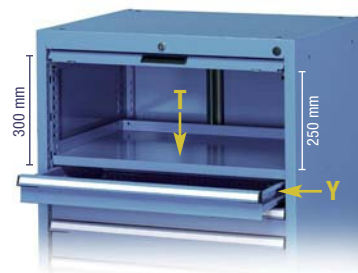

■ The two stops (ref. B) are not required when the door is fitted along with the adjustable shelf (ref. T) ORD. NO. F DF 9100 01 ..

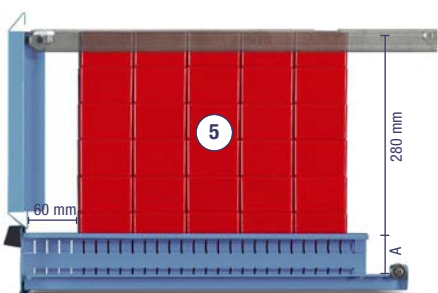

A = usable height of the drawer
Warning: the 60 mm distance from the drawer edge should be respected only if the door has to be closed with the two brackets (Ref. C)

RACK



ORD. NO.
C MV 99 126

Standard (600x150 mm) CD or DVD rack.
Warning: The rack is supplied with a length of 36 Eh (600 mm).

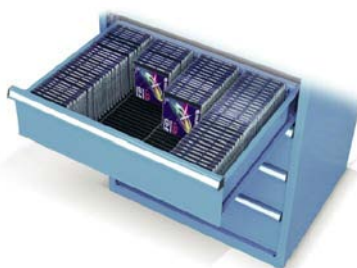

■ 120 standard CD or DVD cases (142x10x125 mm) can be stored into the 175 mm h drawer (with 4 ORD. NO. C MV 99 126 racks). The cases can be stored with their **spines facing upwards**. The racks are supplied with a length of 36 Eh (600 mm), therefore 9 Eh (153 mm) must be cut in order for them to fit into the drawer.

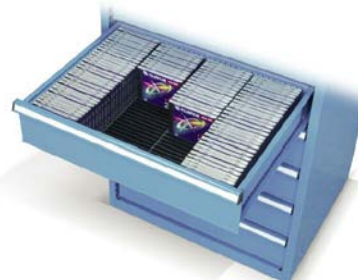

■ 120 standard CD or DVD cases (142x10x125 mm) can be stored into the 150 mm h drawer (with 4 ORD. NO. C MV 99 126 racks). The cases can be stored with their **spines facing sideways**. The racks are supplied with a length of 36 Eh (600 mm), therefore 9 Eh (153 mm) must be cut in order for them to fit into the drawer.

PERFORATED BACK PANELS

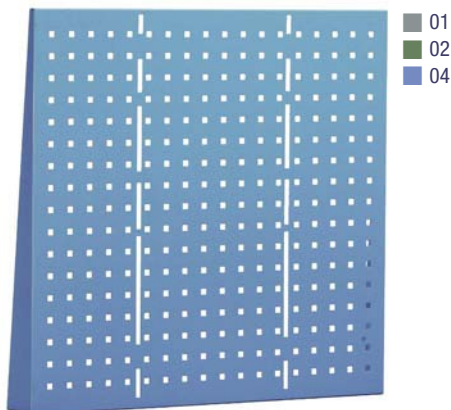

ORD. NO.	DIMENSIONS mm
F DF 7942 00 04	717x93x420 h
F DF 7970 00 04	717x93x700 h

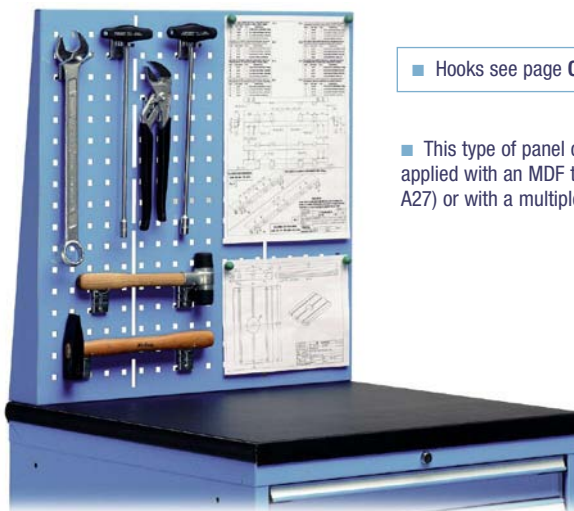

■ Hooks see page C66

■ This type of panel can be applied with an MDF top (see page A27) or with a multiplex worktop.

LENGTH = 717 mm DEPTH = 600 mm (36x27 Eh)

CABINETS SERIES FLEXA

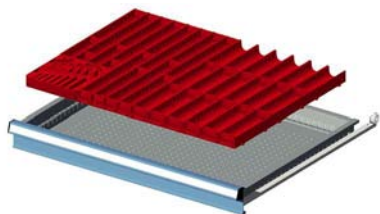

ORD. NO.	FOR FRONT HEIGHTS
F FH 1005 15 00	50-300
Set including:	
5 Troughs	4 grooves
20 Plain partitions	36 mm
6 Troughs	3 grooves
20 Plain partitions	47 mm
1 Allen key tray	150x150 mm

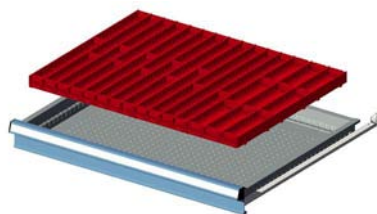

ORD. NO.	FOR FRONT HEIGHTS
F FH 1005 10 00	50-300
Set including:	
9 Troughs	4 grooves
36 Plain partitions	36 mm
3 Troughs	3 grooves
12 Plain partitions	47 mm

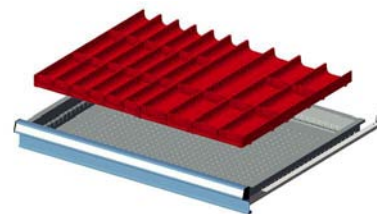

ORD. NO.	FOR FRONT HEIGHTS
F FH 1005 13 00	50-300
Set including:	
6 Troughs	3 grooves
18 Plain partitions	47 mm
6 Troughs	2 grooves
12 Plain partitions	73 mm

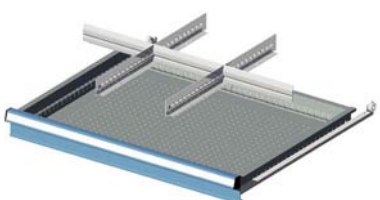

ORD. NO.	FOR FRONT HEIGHTS
F FH 1005 05 00	50
F FH 1007 05 00	75
F FH 1010 05 00	100-125
F FH 1015 05 00	150-175
F FH 1020 05 00	200-250
F FH 1030 05 00	300
Set including:	
2 Slotted partitions	455 mm
3 Plain partitions	200 mm

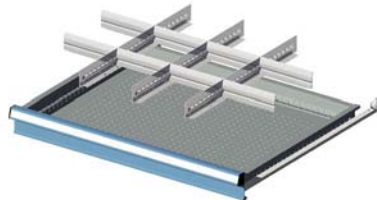

ORD. NO.	FOR FRONT HEIGHTS
F FH 1005 03 00	50
F FH 1007 03 00	75
F FH 1010 03 00	100-125
F FH 1015 03 00	150-175
F FH 1020 03 00	200-250
Set including:	
3 Slotted partitions	455 mm
8 Plain partitions	149 mm

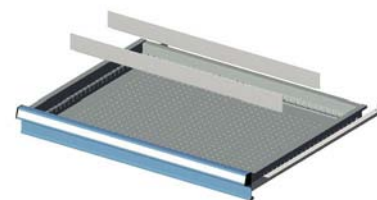

ORD. NO.	FOR FRONT HEIGHTS
F FH 1005 01 00	50
F FH 1007 01 00	75
F FH 1010 01 00	100-125
F FH 1015 01 00	150-175
F FH 1020 01 00	200-250
F FH 1030 01 00	300
Set including:	
2 Plain partitions	610 mm

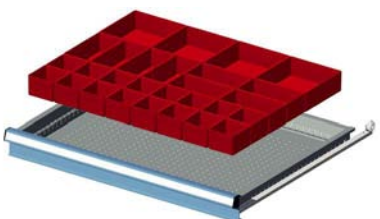

ORD. NO.	FOR FRONT HEIGHTS
F FH 1005 18 00	50
F FH 1007 18 00	75
Set including:	
16 Plastic boxes	75x75 mm
8 Plastic boxes	150x75 mm
4 Plastic boxes	150x150 mm

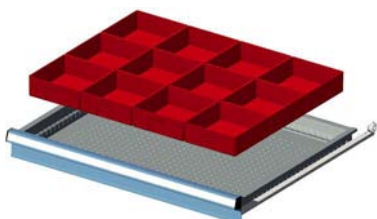

ORD. NO.	FOR FRONT HEIGHTS
F FH 1005 09 00	50
F FH 1007 09 00	75
F FH 1010 09 00	100-125
Set including:	
12 Plastic boxes	150x150 mm

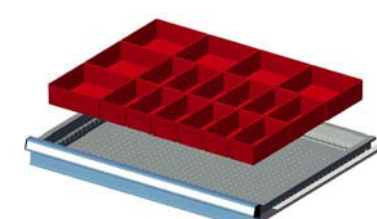

ORD. NO.	FOR FRONT HEIGHTS
F FH 1005 16 00	50
F FH 1007 16 00	75
F FH 1010 16 00	100-125
Set including:	
12 Plastic boxes	150x75 mm
6 Plastic boxes	150x150 mm

■ INFO

www.famispa.com

■ Partitioning material: see page A180



CABINETS SERIES FLEXA

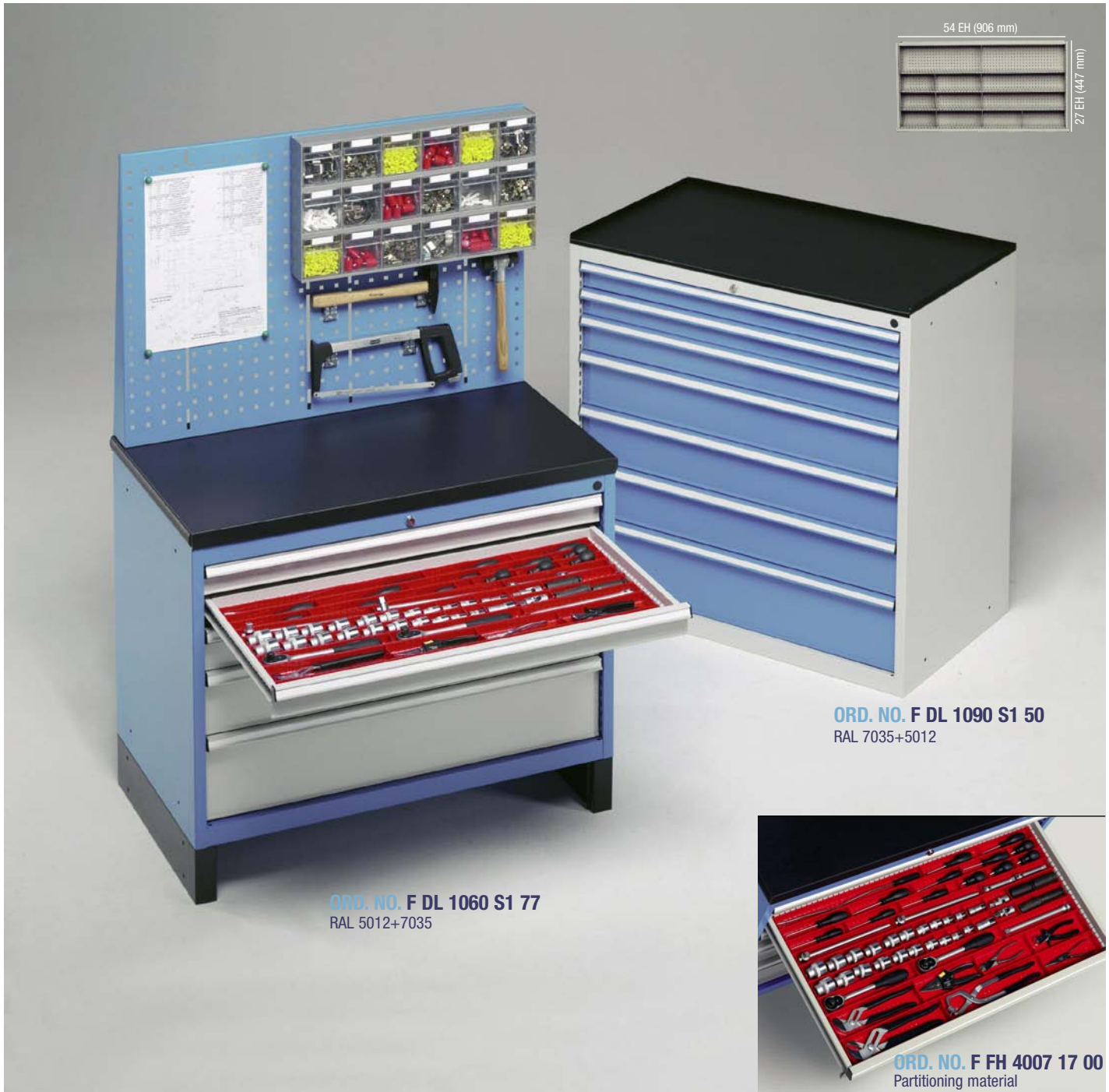

ORD. NO. F DL 1060 S1 77
RAL 5012+7035

ORD. NO. F DL 1090 S1 50
RAL 7035+5012

ORD. NO. F FH 4007 17 00
Partitioning material

FIXING SET



2x

- 2 "HILTI" plugs for concrete floors ≥ to classes B25/RBK250/MPA 25 N/mm²
- Recommended traction of the plug: 2.9 KN
- Plug diameter: Ø 6 mm

ORD. NO. F AG 9204 00 99

CABINET

ORD. NO.	DRAWERS
F DL 1060 S1 77	5
Complete with 5 drawers, 1 pair of plinths, 1 multi-purpose back panel with hooks and Practibox, 1 covering MDF top with rubber	
Dimensions mm 1023x600x860/1560 h	
Tools and partitioning material excluded	

CABINET

ORD. NO.	DRAWERS
F DL 1090 S1 50	7
Complete with 7 drawers, 1 rubber cover top with 3 edges	
Dimensions mm 1023x600x1000 h	

RAL 7000 F.01 RAL 6011 F.02 RAL 5012 F.04 RAL 7035 F.08

SUPPLEMENTARY PARTS ■

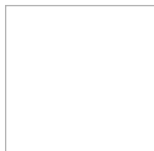
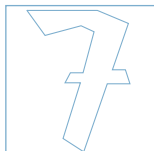

■ Partitioning material: see page A34

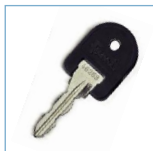

- **Spare key.** Always indicate the number on the cylinder lock of the key to be replaced.
ORD. NO. R CSC 0002 00
- **Master key.** This type of key opens all the 45 and 46 series locks.
ORD. NO. R CSC 0001 00



LENGTH = 1023 mm DEPTH = 600 mm (54x27 Eh)

CABINETS SERIES FLEXA



ORD. NO.	DRAWERS
F DL 1030 51 04	2
Cabinet with 2 full extension drawers	
Dimensions mm 1023x600x400 h	
Central lock	



ORD. NO.	DRAWERS
F DL 1030 54 04	3
Cabinet with 3 full extension drawers	
Dimensions mm 1023x600x400 h	
Central lock	



ORD. NO.	DRAWERS
F DL 1060 51 04	4
Cabinet with 4 full extension drawers	
Dimensions mm 1023x600x700 h	
Central lock	



ORD. NO.	DRAWERS
F DL 1060 52 04	5
Cabinet with 5 full extension drawers	
Dimensions mm 1023x600x700 h	
Central lock	



EXAMPLE INCLUDING:

ORD. NO.
F DL 1070 54 FN
Cabinet complete with 8 drawers
1 pair of plinths
1 covering MDF top with rubber
Dimensions mm 1023x600x960 h
Tools and partitioning material excluded

KEY



- The cabinets must be secured to the floor or to the wall.
- T = full extension (100%)

RAL 7000 F.01 RAL 6011 F.02 RAL 5012 F.04 RAL 7035 F.08

■ Partitioning material: see page A34

■ Partitioning material: see page A180



CABINETS SERIES FLEXA



ORD. NO.	DRAWERS
F DL 1070 51 04	4
Cabinet with 4 full extension drawers	
Dimensions mm 1023x600x800 h	
Central lock	



ORD. NO.	DRAWERS
F DL 1070 52 04	5
Cabinet with 5 full extension drawers	
Dimensions mm 1023x600x800 h	
Central lock	



ORD. NO.	DRAWERS
F DL 1090 54 04	7
Cabinet with 7 full extension drawers	
Dimensions mm 1023x600x1000 h	
Central lock	



ORD. NO.	DRAWERS
F DL 1090 55 04	8
Cabinet with 8 full extension drawers	
Dimensions mm 1023x600x1000 h	
Central lock	

RAL 7000 F.01 RAL 6011 F.02 RAL 5012 F.04 RAL 7035 F.08

KEY ■

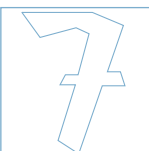

■ Partitioning material: see page A34

- The cabinets must be secured to the floor or to the wall.
- T = full extension (100%)



LENGTH = 1023 mm DEPTH = 600 mm (54x27 Eh)

CABINETS SERIES FLEXA

EMPTY CABINETS

ORD. NO.	USABLE HEIGHT mm	LOAD CAPACITY kg	DIMENSIONS mm
F DL 1030 00 04	300	400	1023x600x400 h
F DL 1060 00 04	600	900	1023x600x700 h
F DL 1070 00 04	700	900	1023x600x800 h
F DL 1090 00 04	900	900	1023x600x1000 h

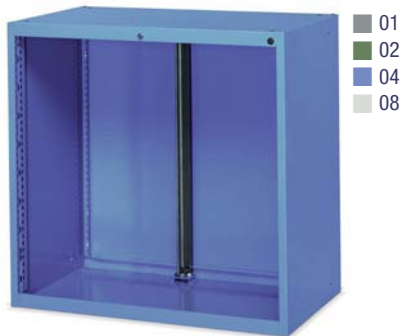

SPARE LOCK

ORD. NO. R CSR 0003 00
for central lock

■ The cabinets must be secured to the floor or to the wall. If the cabinets are stacked they must be secured to the wall and their load capacity must be divided by 2. Further information for fixing set see page A30.

■ Drawers cannot be fitted behind doors.

DRAWERS

ORD. NO.	FRONT HEIGHT mm	LOAD CAPACITY kg	USABLE DIMENSIONS mm
F DL 8075 00 04	75	50	906x447x61 h
F DL 8100 00 04	100	50	906x447x86 h
F DL 8150 00 04	150	50	906x447x136 h
F DL 8175 00 04	175	50	906x447x161 h
F DL 8200 00 04	200	50	906x447x186 h

Full extension (100%)

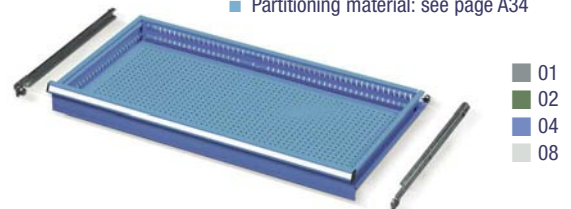

■ Partitioning material: see page A34

ADJUSTABLE SHELVES

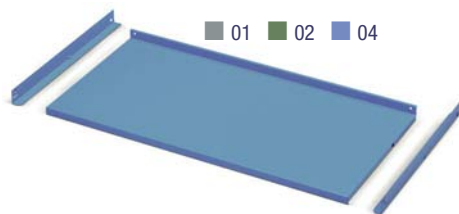

ORD. NO.	USABLE DIMENSIONS mm
F DL 9100 01 04	960x460

Side height: 25
Load capacity kg: 70 Without extension system

TOP



ORD. NO.	DIMENSIONS mm
F DL 9150 01 07	1023x600x20 h

Rubber cover top with 3 edges
Oil-resistant rubber mat

PAIR OF PLINTHS



ORD. NO.	HEIGHT mm
F RR 1608 00 07	130

PERFORATED BACK PANELS

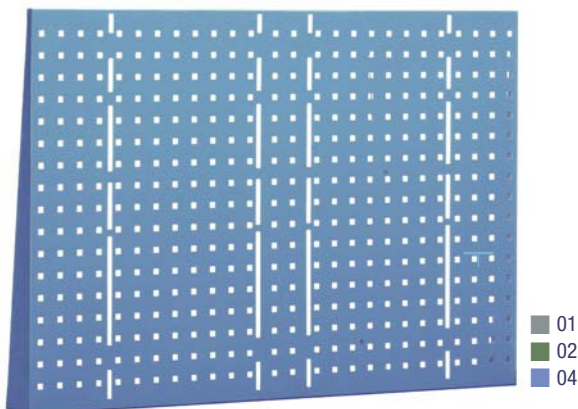

ORD. NO.	DIMENSIONS mm
F DL 7942 00 04	1016x93x420 h
F DL 7970 00 04	1016x93x700 h



■ Hooks see page C66

■ This type of panel can be applied with an MDF top (see page A35) or with a multiplex worktop (see page A36).

LENGTH = 1023 mm DEPTH = 600 mm (54x27 Eh)

CABINETS SERIES FLEXA

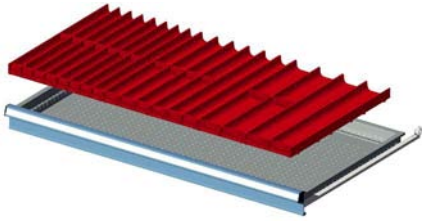

ORD. NO.	FOR FRONT HEIGHTS
----------	-------------------

F FH 4005 12 00	50-300
Set including:	
6 Troughs	4 grooves
15 Plain partitions	36 mm
6 Troughs	3 grooves
10 Plain partitions	47 mm
6 Troughs	2 grooves
6 Plain partitions	73 mm

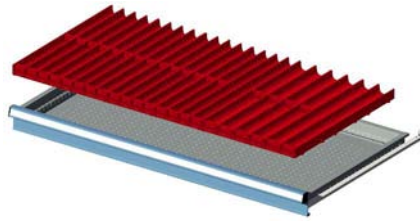

ORD. NO.	FOR FRONT HEIGHTS
----------	-------------------

F FH 4005 15 00	50-300
Set including:	
12 Troughs	4 grooves
30 Plain partitions	36 mm
6 Troughs	3 grooves
10 Plain partitions	47 mm



ORD. NO.	FOR FRONT HEIGHTS
----------	-------------------

F FH 4005 01 00	50
F FH 4007 01 00	75
F FH 4010 01 00	100-125
F FH 4015 01 00	150-175
F FH 4020 01 00	200-250
F FH 4030 01 00	300
Set including:	
2 Plain partitions	914 mm

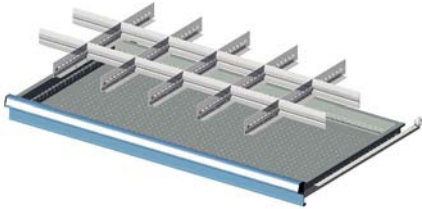

ORD. NO.	FOR FRONT HEIGHTS
----------	-------------------

F FH 4005 03 00	50
F FH 4007 03 00	75
F FH 4010 03 00	100-125
F FH 4015 03 00	150-175
F FH 4020 03 00	200-250
Set including:	
5 Slotted partitions	455 mm
12 Plain partitions	149 mm

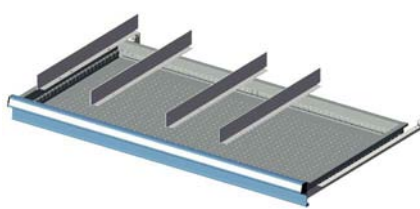

ORD. NO.	FOR FRONT HEIGHTS
----------	-------------------

F FH 4005 04 00	50
F FH 4007 04 00	75
F FH 4010 04 00	100-125
F FH 4015 04 00	150-175
F FH 4020 04 00	200-250
Set including:	
4 Plain partitions	455 mm

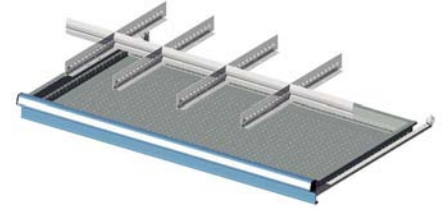

ORD. NO.	FOR FRONT HEIGHTS
----------	-------------------

F FH 4005 05 00	50
F FH 4007 05 00	75
F FH 4010 05 00	100-125
F FH 4015 05 00	150-175
F FH 4020 05 00	200-250
Set including:	
4 Slotted partitions	455 mm
2 Plain partitions	149 mm
3 Plain partitions	200 mm

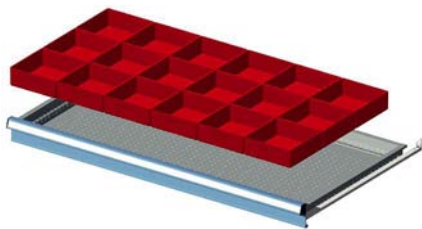

ORD. NO.	FOR FRONT HEIGHTS
----------	-------------------

F FH 4005 11 00	50
F FH 4007 11 00	75
F FH 4010 11 00	100-125
Set including:	
18 Plastic boxes	150x150 mm

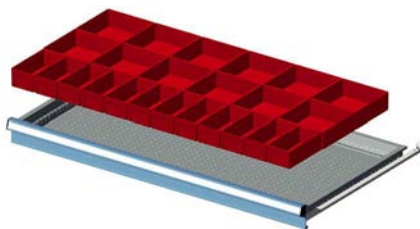

ORD. NO.	FOR FRONT HEIGHTS
----------	-------------------

F FH 4005 13 00	50
F FH 4007 13 00	75
F FH 4010 13 00	100-125
Set including:	
12 Plastic boxes	150x75 mm
12 Plastic boxes	150x150 mm

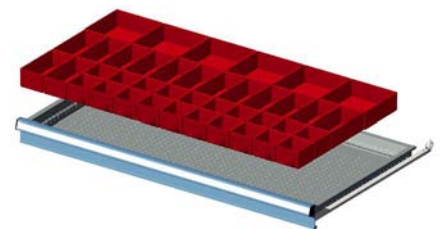

ORD. NO.	FOR FRONT HEIGHTS
----------	-------------------

F FH 4005 16 00	50
F FH 4007 16 00	75
Set including:	
20 Plastic boxes	75x75 mm
14 Plastic boxes	150x75 mm
6 Plastic boxes	150x150 mm

INFO ■

■ Partitioning material: see page **A180**

www.famispa.com



LENGTH = 1023 mm DEPTH = 600 mm (54x27 Eh)

CABINETS SERIES FLEXA

UPPER MDF TOP WITH RUBBER COVERING DIMENSIONS 1024x600x31,5 mm H

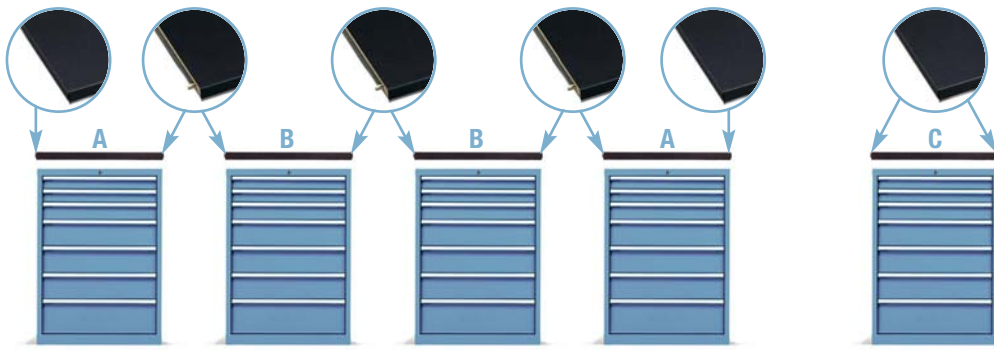

Detail of the oil-resistant rubber



A



B



C

ORD. NO.

F UZ 3140 11 07

MDF top with rubber covering

Side profile

For end cabinets

Oil-resistant rubber mat

ORD. NO.

F UZ 3140 12 07

MDF top with rubber covering

No side profile

For additional central cabinets Oil-resist. rubber mat

ORD. NO.

F UZ 3140 13 07

MDF top with rubber covering

2 side profiles

For single cabinet

Oil-resistant rubber mat



ORD. NO.

DRAWERS

F DL 1090 51 04

5

Cabinet with 5 full extension drawers

Dimensions mm 1023x600x1000 h

Central lock

■ 180 standard CD or DVD cases (142x10x125 mm) can be stored into the 175 mm h drawer (with 6 ORD. NO. C MV 99 126 racks). The cases can be stored with their **spines facing upwards**.

The racks are supplied with a length of 36 Eh (600 mm), therefore 9 Eh (153 mm) must be cut in order for them to fit into the drawer.

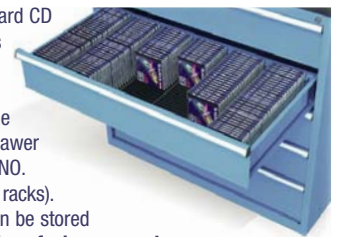

■ 180 standard CD or DVD cases (142x10x125 mm) can be stored into the 150 mm h drawer (with 6 ORD. NO. C MV 99 126 racks). The cases can be stored with their **spines facing sideways**.

The racks are supplied with a length of 36 Eh (600 mm), therefore 9 Eh (153 mm) must be cut in order for them to fit into the drawer.

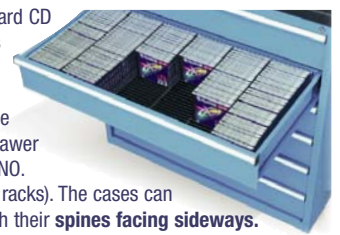

ORD. NO.

DRAWERS

F DL 1090 52 04

6

Cabinet with 6 full extension drawers

Dimensions mm 1023x600x1000 h

Central lock

RACK

ORD. NO.

C MV 99 126

Standard (600x150 mm) CD or DVD rack.

Warning: The rack is supplied with a length of 36 Eh (600 mm).



KEY

RAL 7000 F.01 RAL 6011 F.02 RAL 5012 F.04 RAL 7035 F.08



- The cabinets must be secured to the floor or to the wall.
- T = full extension (100%)



CABINETS SERIES FLEXA

**STORAGE CAPACITY WITH THE SPINES OF THE CASES (DIM. 142x10x125 mm)
LATERALLY POSITIONED: 5640 CD/DVD**

ORD. NO.**F DL ZA01 00 56**

Example including:

7 cabinets, 38 drawers, 188 CD/DVD racks

2 flap doors, 2 adjustable shelves, 3 PVC cover MDF tops

Dimensions mm 4202x600x1030/2000 h

Tools and CD/DVD excluded



RAL 7000 F.01

RAL 6011 F.02

RAL 5012 F.04

RAL 7035 F.08

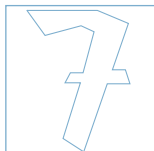
KEY ■

- The cabinets must be secured to the floor or to the wall.



LENGTH = 1023 mm DEPTH = 600 mm (54x27 Eh)

CABINETS SERIES FLEXA



■ RAL 7035 + ■ RAL 7000

■ KEY

RAL 7000 F.01 RAL 6011 F.02 RAL 5012 F.04 RAL 7035 F.08



■ The cabinets must be secured to the floor or to the wall.



WORKSTATIONS SERIES FLEXA



ORD. NO. F CB H610 S1 50
RAL 7035+5012

ORD. NO.
F FH 1010 20 00

LOAD CAPACITY

- Workstation: 250 kg
- Drawer: 70 kg
- Adjustable shelf: 70 kg
- Retractable shelf: 70 kg
- 4 edged tray: 70 kg
- Worktop: 250 kg

MOBILE WORKSTATION

ORD. NO.	DRAWERS
F CB H610 S1 50	4

Complete with 4 drawers
1 electric system, 1 pneumatic system,
1 flap door, 1 door, 1 retractable shelf,
1 multi-purpose back panel with accessories

Dimensions mm 1227x700x915/1335 h

Tools excluded

PARTITIONING MATERIAL

ORD. NO.
F FH 1010 20 00

Partitioning material for drawers
ORD. NO. F DF 8100 00 .. (36x27 Eh height 100 mm)

RAL 7000 F.01

RAL 6011 F.02

RAL 5012 F.04

RAL 7035 F.08

KEY ■



■ Partitioning material: see page A180

■ Detail of the height adjustable shelves (PR) with load capacity of 70 kg.



■ All indicated loads are net and refer to evenly distributed weights.



MOBILE WORKSTATION INCLUDING 1 19 EH CABINET + 1 27 EH CABINET



RAL 7000



MOBILE WORKSTATION

ORD. NO.

F CB H440 S1 01

- 4 drawers
- 2 adjustable shelves
- 2 storage containers
- 2 tops with 4 edges

Dimensions mm 1070x600x907 h

Tools and partitioning material excluded

MOBILE WORKSTATION INCLUDING 1 27 EH CABINET + 1 27 EH CABINET



RAL 7035 + RAL 7000



■ Vices can be fixed on the 30 mm thick worktops. See page C77 for further information.



MOBILE WORKSTATION

ORD. NO.

F CB H510 S1 56

- 2 doors
- 8 adjustable shelves
- 8 Tecno Store toolboxes with plastic boxes
- 2 retractable shelves
- 6 Multibox boxes

Dimensions mm 1227x700x915 h

Tools excluded

KEY

RAL 7000 F.01 RAL 6011 F.02 RAL 5012 F.04 RAL 7035 F.08



■ All indicated loads are net and refer to evenly distributed weights.



■ Detail of the height adjustable shelves (PR) with load capacity of 70 kg.

■ Partitioning material: see page A180



WORKSTATIONS SERIES FLEXA

MOBILE WORKSTATIONS INCLUDING 1 19 EH CABINET + 1 19 EH CABINET



■ Detail of the height adjustable shelves (PR) with load capacity of 70 kg.

LOAD CAPACITY

- Workstation: 250 kg
- Drawer: 70 kg
- Adjustable shelf: 70 kg
- 4 edged tray: 70 kg
- Worktop: 250 kg

WORKSTATION WITH MULTIPLEX WORKTOP INCLUDING

ORD. NO.

DRAWERS

F CB H320 01 04

4

2 standard rubber swivel wheels with brakes and
2 standard rubber fixed wheels Ø 150 mm in

4 full extension drawers

2 height adjustable shelves

Overall dimensions mm 937x600x910 h

Multiplex worktop dimensions mm 860x600x25 h

1 lock with anti-tilt rod



■ RAL 7035

MOBILE WORKSTATION

ORD. NO.

F CB H320 S1 08

5 drawers, 1 tray with 4 edges, 3 storage containers
1 rear edge, 2 side edges

Dimensions mm 937x600x910/985 h

Tools and partitioning material excluded

RAL 7000 F.01

RAL 6011 F.02

RAL 5012 F.04

RAL 7035 F.08

KEY ■

■ Partitioning material: see page A180

■ Partitioning material: see page A9

- PR = height adjustable shelf
- T = full extension (100%)
- All indicated loads are net and refer to evenly distributed weights.



WORKSTATION WITH MULTIPLEX WORKTOP INCLUDING

ORD. NO. DRAWERS

F CB H320 04 04 42 standard rubber swivel wheels with brakes and
2 standard rubber fixed wheels Ø 150 mm

4 full extension drawers

2 height adjustable 4 edged trays

Overall dimensions mm 937x600x910 h**Multiplex worktop dimensions mm 860x600x25 h**

1 lock with anti-tilt rod



BACK UPSTAND



ORD. NO.

F BL 5690 00 00

For multiplex worktop dimensions mm 860x600x25 h

SIDE UPSTAND



ORD. NO.

F BL 5595 00 00

For multiplex worktop dimensions mm 860x600x25 h

WORKSTATION WITH MULTIPLEX WORKTOP INCLUDING

ORD. NO. DRAWERS

F CB H330 01 04 42 standard rubber swivel wheels with brakes and
2 standard rubber fixed wheels Ø 150 mm

4 full extension drawers

2 height adjustable shelves

4 practibox drawer units

Overall dimensions mm 1072x600x910 h**Multiplex worktop dimensions mm 995x600x25 h**

1 lock with anti-tilt rod

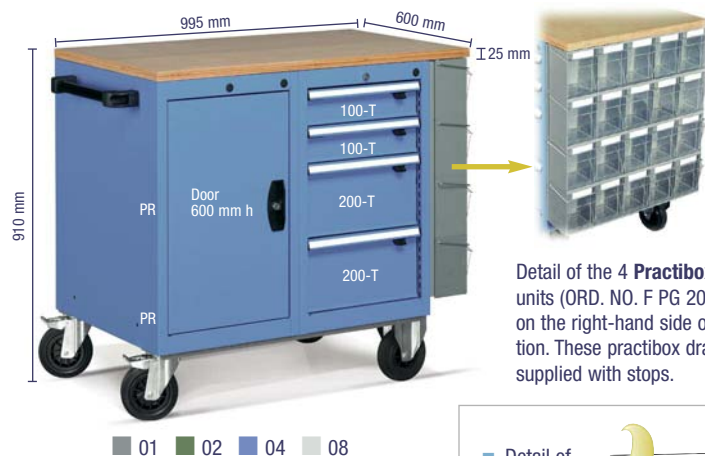

Detail of the 4 Practibox series drawer units (ORD. NO. F PG 2071 01 01) fixed on the right-hand side of the workstation. These practibox drawer units are supplied with stops.

BACK UPSTAND



ORD. NO.

F BL 5705 00 00

For multiplex worktop dimensions mm 995x600x25 h

SIDE UPSTAND



ORD. NO.

F BL 5595 00 00

For multiplex worktop dimensions mm 995x600x25 h



Detail of the catches

KEY

RAL 7000 F.01 RAL 6011 F.02 RAL 5012 F.04 RAL 7035 F.08



Detail of the height adjustable shelves (PR) with load capacity of 70 kg.

Partitioning material: see page A9



- PR = height adjustable shelf
- VR = height adjustable 4 edged tray
- T = full extension (100%)
- All indicated loads are net and refer to evenly distributed weights.

WORKSTATIONS SERIES FLEXA

MOBILE WORKSTATIONS INCLUDING 1 19 EH CABINET + 1 27 EH CABINET



■ Detail of the height adjustable shelves (PR) with load capacity of 70 kg.

LOAD CAPACITY

- Workstation: 250 kg
- Drawer: 70 kg
- Adjustable shelf: 70 kg
- Retractable shelf: 70 kg
- 4 edged tray: 70 kg
- Worktop: 250 kg

WORKSTATION WITH MULTIPLEX WORKTOP INCLUDING

ORD. NO.	DRAWERS
F CB H420 01 04	4
2 standard rubber swivel wheels with brakes and 2 standard rubber fixed wheels Ø 150 mm	
4 full extension drawers	
2 height adjustable shelves	
Overall dimensions mm 1072x600x910 h	
Multiplex worktop dimensions mm 995x600x25 h	
1 lock with anti-tilt rod	

WORKSTATION WITH MULTIPLEX WORKTOP INCLUDING

ORD. NO.	DRAWERS
F CB H420 02 04	4
2 standard rubber swivel wheels with brakes and 2 standard rubber fixed wheels Ø 150 mm	
4 full extension drawers	
2 height adjustable shelves	
Overall dimensions mm 1072x600x910 h	
Multiplex worktop dimensions mm 995x600x25 h	
2 locks with 300 mm h side rod	

WORKSTATION WITH MULTIPLEX WORKTOP INCLUDING

ORD. NO.	DRAWERS
F CB H420 03 04	4
2 standard rubber swivel wheels with brakes and 2 standard rubber fixed wheels Ø 150 mm	
4 full extension drawers	
2 full retractable shelves	
Overall dimensions mm 1072x600x910 h	
Multiplex worktop dimensions mm 995x600x25 h	
2 locks with anti-tilt rod	

■ Detail of the full retractable shelves (PE) with load capacity of 70 kg.



RAL 7000 F.01 RAL 6011 F.02 RAL 5012 F.04 RAL 7035 F.08

KEY

■ Partitioning material: see page A9 and page A19

- PE = full extension retractable shelf (100%)
- PR = height adjustable shelf
- T = full extension (100%)
- All indicated loads are net and refer to evenly distributed weights.



WORKSTATION WITH MULTIPLEX WORKTOP INCLUDING

ORD. NO.	DRAWERS
F CB H420 04 04	4
2 standard rubber swivel wheels with brakes and 2 standard rubber fixed wheels Ø 150 mm	
4 full extension drawers	
2 height adjustable 4 edged trays	
Overall dimensions mm 1072x600x910 h	
Multiplex worktop dim. mm 995x600x25 h	
1 lock with anti-tilt rod	

**BACK UPSTAND****ORD. NO.****F BL 5705 00 00**For multiplex worktop
dimensions mm 995x600x25 h**SIDE UPSTAND****ORD. NO.****F BL 5595 00 00**For multiplex worktop
dimensions mm 995x600x25 h**WORKSTATION WITH TWO 4 EDGED TOPS:**

ORD. NO.	DRAWERS
F CB H440 01 04	4
2 standard rubber swivel wheels with brakes and 2 standard rubber fixed wheels Ø 150 mm	
4 full extension drawers	
2 height adjustable shelves	
Overall dimensions mm 1070x600x907 h	
1 lock with anti-tilt rod	



- 4 edged top including oil-resistant rubber.
- Worktop load capacity: 80+80 kg

WORKSTATION WITH MULTIPLEX WORKTOP INCLUDING

ORD. NO.	DRAWERS
F CB H430 01 04	4
2 standard rubber swivel wheels with brakes and 2 standard rubber fixed wheels Ø 150 mm	
4 full extension drawers	
2 height adjustable shelves	
4 practibox drawer units	
Overall dimensions mm 1227x600x910 h	
Multiplex worktop dim. mm 1150x600x25 h	
1 lock with anti-tilt rod	



Detail of the 4 **Practibox** series drawer units (ORD. NO. F PG 2071 01 01) fixed on the right-hand side of the workstation. These practibox drawer units are supplied with catches.

BACK UPSTAND**ORD. NO.****F BL 5715 00 00**For multiplex worktop **dim. mm 1150x600x25 h****SIDE UPSTAND****ORD. NO.****F BL 5595 00 00**For multiplex worktop **dim. mm 1150x600x25 h**

- Detail of the catches

KEY

RAL 7000 F.01 RAL 6011 F.02 RAL 5012 F.04 RAL 7035 F.08



- Detail of the height adjustable shelves (PR) with load capacity of 70 kg.

- Partitioning material: see page A9 and page A19



- PR = height adjustable shelf
- VR = height adjustable 4 edged tray
- T = full extension (100%)
- All indicated loads are net and refer to evenly distributed weights.

WORKSTATIONS SERIES FLEXA

MOBILE WORKSTATIONS INCLUDING 1 27 EH CABINET + 1 27 EH CABINET



■ Detail of the height adjustable shelves (PR) with load capacity of 70 kg.

LOAD CAPACITY

- Workstation: 250 kg
- Drawer: 70 kg
- Adjustable shelf: 70 kg
- Retractable shelf: 70 kg
- 4 edged tray: 70 kg
- Worktop: 250 kg

WORKSTATION WITH MULTIPLEX WORKTOP INCLUDING

ORD. NO.	DRAWERS
F CB H510 01 04	4
2 standard rubber swivel wheels with brakes and 2 standard rubber fixed wheels Ø 150 mm	
4 full extension drawers	
2 height adjustable shelves	
Overall dimensions mm 1227x700x915 h	
Multiplex worktop dimensions mm 1150x700x30 h	
1 lock with anti-tilt rod	

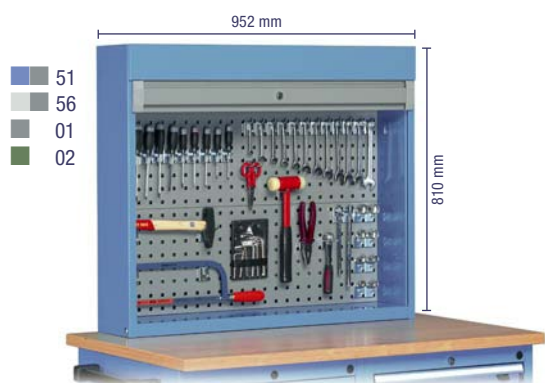

ROLLER SHUTTER CABINET

ORD. NO.
F BL 7011 03 51
Overall dimensions mm 952x210x810 h
Internal dimensions mm 905x150x581 h
Hooks and tools excluded

SET OF 41 HOOKS

ORD. NO.
F BL 9511 00 99



WORKSTATION WITH MULTIPLEX WORKTOP INCLUDING

ORD. NO.	DRAWERS
F CB H510 03 04	4
2 standard rubber swivel wheels with brakes and 2 standard rubber fixed wheels Ø 150 mm	
4 full extension drawers	
2 full retractable shelves	
Overall dimensions mm 1227x700x915 h	
Multiplex worktop dimensions mm 1150x700x30 h	
2 locks with anti-tilt rod	

■ Detail of the full retractable shelves (PE) with load capacity of 70 kg.



RAL 7000 F.01 RAL 6011 F.02 RAL 5012 F.04 RAL 7035 F.08

KEY ■

■ Partitioning material: see page A19

- PE = full extension retractable shelf (100%)
- PR = height adjustable shelf
- T = full extension (100%)
- All indicated loads are net and refer to evenly distributed weights.



**WORKSTATION WITH MULTIPLEX
WORKTOP INCLUDING**

ORD. NO.	DRAWERS
F CB H510 04 04	4
2 standard rubber swivel wheels with brakes and 2 standard rubber fixed wheels Ø 150 mm	
4 full extension drawers	
2 height adjustable 4 edged trays	
Overall dimensions mm 1227x700x915 h	
Multiplex worktop dim. mm 1150x700x30 h	
1 lock with anti-tilt rod	



■ 01 ■ 02 ■ 04 ■ 08

BACK UPSTAND**ORD. NO.****F BL 5715 00 00**

For multiplex worktop
dimensions mm 1150x700x30 h

SIDE UPSTAND**ORD. NO.****F BL 5605 00 00**

For multiplex worktop
dimensions mm 1150x700x30 h

**WORKSTATION WITH TWO 4 EDGED
TOPS:**

ORD. NO.	DRAWERS
F CB H540 01 04	4
2 standard rubber swivel wheels with brakes and 2 standard rubber fixed wheels Ø 150 mm	
4 full extension drawers	
2 height adjustable shelves	
Overall dimensions mm 1206x600x907 h	
1 lock with anti-tilt rod	



■ 01 ■ 02 ■ 04 ■ 08

- 4 edged top including oil-resistant rubber.
- Worktop load capacity: 80+80 kg

**WORKSTATION WITH MULTIPLEX
WORKTOP INCLUDING**

ORD. NO.	DRAWERS
F CB H530 01 04	4
2 standard rubber swivel wheels with brakes and 2 standard rubber fixed wheels Ø 150 mm	
4 full extension drawers	
2 height adjustable shelves	
4 practibox drawer units	
Overall dimensions mm 1352x600x910 h	
Multiplex worktop dim. mm 1275x600x25 h	
1 lock with anti-tilt rod	



■ 01 ■ 02 ■ 04 ■ 08



Detail of the 4 **Practibox** series drawer units (ORD. NO. F PG 2071 01 01) fixed on the right-hand side of the workstation. These practibox drawer units are supplied with catches.

BACK UPSTAND**ORD. NO.****F BL 5719 00 00**

For multiplex worktop **dim. mm 1275x600x25 h**

SIDE UPSTAND**ORD. NO.****F BL 5595 00 00**

For multiplex worktop **dim. mm 1275x600x25 h**

■ Detail of the catches

■ **KEY**

RAL 7000 F.01 RAL 6011 F.02 RAL 5012 F.04 RAL 7035 F.08



■ Detail of the height adjustable shelves (PR) with load capacity of 70 kg.

■ Partitioning material: see page A19



- PR = height adjustable shelf
- VR = height adjustable 4 edged tray
- T = full extension (100%)
- All indicated loads are net and refer to evenly distributed weights.

WORKSTATIONS SERIES FLEXA

MOBILE WORKSTATIONS INCLUDING 1 19 EH CABINET + 1 36 EH CABINET



- LOAD CAPACITY**
- Workstation: 250 kg
 - Drawer: 70 kg
 - Adjustable shelf: 70 kg
 - Retractable shelf: 70 kg
 - 4 edged tray: 70 kg
 - Worktop: 250 kg

WORKSTATION WITH MULTIPLEX WORKTOP INCLUDING

ORD. NO.	DRAWERS
F CB H610 01 04	4
2 standard rubber swivel wheels with brakes and 2 standard rubber fixed wheels Ø 150 mm	
4 full extension drawers	
2 height adjustable shelves	
Overall dimensions mm 1227x700x915 h	
Multiplex worktop dimensions mm 1150x700x30 h	
1 lock with anti-tilt rod	

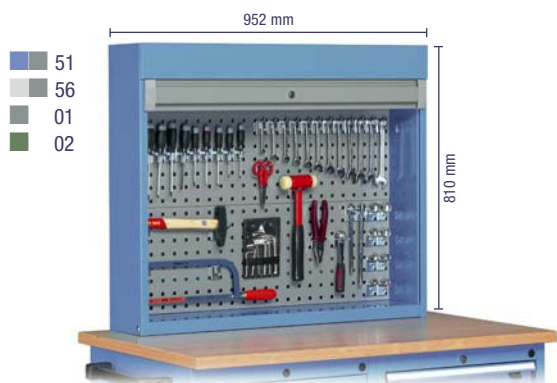

ROLLER SHUTTER CABINET

ORD. NO.
F BL 7011 03 51
Overall dimensions mm 952x210x810 h
Internal dimensions mm 905x150x581 h
Hooks and tools excluded

SET OF 41 HOOKS

ORD. NO.
F BL 9511 00 99



WORKSTATION WITH MULTIPLEX WORKTOP INCLUDING

ORD. NO.	DRAWERS
F CB H610 03 04	4
2 standard rubber swivel wheels with brakes and 2 standard rubber fixed wheels Ø 150 mm	
4 full extension drawers	
2 full retractable shelves	
Overall dimensions mm 1227x700x915 h	
Multiplex worktop dimensions mm 1150x700x30 h	
2 locks with anti-tilt rod	

■ Detail of the full retractable shelves (PE) with load capacity of 70 kg.



- RAL 7000 F.01
- RAL 6011 F.02
- RAL 5012 F.04
- RAL 7035 F.08

KEY

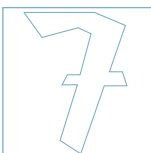

■ Partitioning material: see page A9 and page A29

- PE = full extension retractable shelf (100%)
- PR = height adjustable shelf
- T = full extension (100%)
- All indicated loads are net and refer to evenly distributed weights.



WORKSTATION WITH MULTIPLEX WORKTOP INCLUDING

ORD. NO.	DRAWERS
F CB H610 04 04	4
2 standard rubber swivel wheels with brakes and 2 standard rubber fixed wheels Ø 150 mm	
4 full extension drawers	
2 height adjustable 4 edged trays	
Overall dimensions mm 1227x700x915 h	
Multiplex worktop dim. mm 1150x700x30 h	
1 lock with anti-tilt rod	



■ Vices can be fixed on the 30 mm thick worktops.
See page C77 for further information.

WORKSTATION WITH MULTIPLEX WORKTOP INCLUDING

ORD. NO.	DRAWERS
F CB H610 05 04	1
2 standard rubber swivel wheels with brakes and 2 standard rubber fixed wheels Ø 150 mm	
1 full extension drawer	
1 height adjustable shelf	
2 height adjustable 4 edged trays	
Overall dimensions mm 1227x700x915 h	
Multiplex worktop dim. mm 1150x700x30 h	
1 lock with side rod	



WORKSTATION WITH TWO 4 EDGED TOPS:

ORD. NO.	DRAWERS
F CB H640 01 04	4
2 standard rubber swivel wheels with brakes and 2 standard rubber fixed wheels Ø 150 mm	
4 full extension drawers	
2 height adjustable shelves	
Overall dimensions mm 1223x600x907 h	
1 lock with anti-tilt rod	



BACK UPSTAND



ORD. NO.

F BL 5715 00 00

For multiplex worktop dimensions mm 1150x700x30 h

SIDE UPSTAND



ORD. NO.

F BL 5605 00 00

For multiplex worktop dimensions mm 1150x700x30 h

BACK UPSTAND



ORD. NO.

F BL 5715 00 00

For multiplex worktop dimensions mm 1150x700x30 h

SIDE UPSTAND



ORD. NO.

F BL 5605 00 00

For multiplex worktop dimensions mm 1150x700x30 h

- 4 edged top including oil-resistant rubber.
- Worktop load capacity: 80+80 kg

KEY

RAL 7000 F.01 RAL 6011 F.02 RAL 5012 F.04 RAL 7035 F.08



■ Detail of the height adjustable shelves (PR) with load capacity of 70 kg.

■ Partitioning material: see page A9 and page A29



- PR = height adjustable shelf
- VR = height adjustable 4 edged tray
- T = full extension (100%)
- All indicated loads are net and refer to evenly distributed weights.

WORKSTATIONS SERIES FLEXA

MOBILE WORKSTATIONS INCLUDING 1 19 EH CABINET + 1 36 EH CABINET



Detail of the 4 Practibox series drawer units (ORD. NO. F PG 2071 01 01) fixed on the right-hand side of the workstation. These practibox drawer units are supplied with catches.

WORKSTATION WITH MULTIPLEX WORKTOP INCLUDING

ORD. NO.	DRAWERS
F CB H630 01 04	4
2 standard rubber swivel wheels with brakes and 2 standard rubber fixed wheels Ø 150 mm	
4 full extension drawers	
2 height adjustable shelves	
4 practibox drawer units	
Overall dimensions mm 1352x600x910 h	
Multiplex worktop dim. mm 1275x600x25 h	
1 lock with anti-tilt rod	



BACK UPSTAND



ORD. NO.
F BL 5719 00 00
For multiplex worktop dim. mm 1275x600x25 h

SIDE UPSTAND



ORD. NO.
F BL 5595 00 00
For multiplex worktop dim. mm 1275x600x25 h



Door 300 mm h
Pneumatic and electric system with drawer 100-T



Possible closure of the flap door by means of the lower drawer. See page A28.

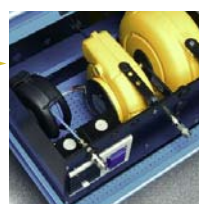

The pneumatic and electric system can be accessed through the lower drawer.

WORKSTATION WITH MULTIPLEX WORKTOP INCLUDING

ORD. NO.	DRAWERS
F CB H610 06 04	7
2 standard rubber swivel wheels with brakes and 2 standard rubber fixed wheels Ø 150 mm	
7 full extension drawers	
1 pneumatic and electric system	
Overall dimensions mm 1227x700x915 h	
Multiplex worktop dim. mm 1150x700x30 h	
2 locks with anti-tilt rod	



Rear 11 metres long pneumatic extension.
Rear 10 metres long electric extension.

ELECTRIC AND PNEUMATIC SYSTEM: please contact FAMI for detailed information

RAL 7000 F.01 RAL 6011 F.02 RAL 5012 F.04 RAL 7035 F.08

KEY

- PR = height adjustable shelf
- T = full extension (100%)
- All indicated loads are net and refer to evenly distributed weights.

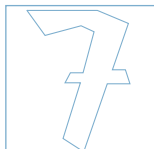

Partitioning material: see page A9 and page A29

Detail of the height adjustable shelves (PR) with load capacity of 70 kg.



- Perforated back panels see page A33
- Hooks see page C66
- Practibox see page G48



■ RAL 7035 + ■ RAL 5012

This system is included in the order no. F CB H610 06 04

SYSTEM INCLUDING:

- 1 (R) electric winder with control unit and differential circuit breaker ORD. NO. F BL 9390 01 00
- 1 (L) 220V Schuko socket ORD. NO. F BL 9395 07 00
- 1 steel frame ORD. NO. F BL 9370 02 07
- 1 (U) pneumatic connection hose (quick connector excluded) ORD. NO. F BL 9401 01 00
- 1 (T) pneumatic feed winder with 11 metres of 10 mm internal Ø hose and 3/8" threaded connector ORD. NO. F BL 9402 02 00
- 1 (B) pneumatic winder with 4 metres of 5,5 mm internal Ø hose and 1/4" threaded connector ORD. NO. F BL 9403 01 00

Electrical system usable power: 1200 W with wound cable, 1800 W with cable completely unwound.

EXAMPLE INCLUDING:

ORD. NO.

F CB H610 S1 50

- 4 drawers
- 1 electric system
- 1 pneumatic system
- 1 flap door
- 1 door
- 1 retractable shelf
- 1 multi-purpose back panel with accessories

Dimensions mm 1227x700x915/1335 h

Tools excluded

■ **KEY**

RAL 7000 F.01 RAL 6011 F.02 RAL 5012 F.04 RAL 7035 F.08



■ Detail of the height adjustable shelves (PR) with load capacity of 70 kg.

■ Partitioning material: see page A9 and page A29



- All indicated loads are net and refer to evenly distributed weights.

WORKSTATIONS SERIES FLEXA

MOBILE WORKSTATION INCLUDING 1 19 EH CABINET + 1 36 EH CABINET



ORD. NO. F CB H620 S1 EF

RAL 7000 F.01

RAL 6011 F.02

RAL 5012 F.04

RAL 7035 F.08

INFO ■



■ Partitioning material: see page A9 and page A29

■ Detail of the height adjustable shelves (PR) with load capacity of 70 kg.



www.famispa.com



MOBILE WORKSTATION INCLUDING 1 19 EH CABINET + 1 27 EH CABINET

EXAMPLE INCLUDING:

ORD. NO.

F CB H430 S1 71

4 drawers

2 trays with 4 edges

3 Top-Box cases

1 frame including Practibox

Dimensions mm 1227x600x910 h

Tools and partitioning material excluded



■ RAL 7000 + ■ RAL 5012

■ Rear view of the mobile workstation. The side bay is also open in the rear section. Up to 3 Top-Box cases can be located inside ORD. NO. F PG 5561 01 04



■ INFO

RAL 7000 F.01

RAL 6011 F.02

RAL 5012 F.04

RAL 7035 F.08



■ Detail of the height adjustable shelves (PR) with load capacity of 70 kg.

■ Partitioning material: see page A9 and page A29





www.famispa.com

RUBBER WHEELS

STANDARD RUBBER WHEELS

	ORD. NO. C RG DAC11 100		\varnothing 100 mm		C 130 mm		SWIVEL WHEEL WITH BRAKE						
	SUITABLE FOR CABINET	FLEXA 19	FLEXA 27	FLEXA 36	FLEXA CB	STANDARD B	STANDARD GE	STANDARD G	STANDARD GG	STANDARD GF	STANDARD GB	STANDARD GC	STANDARD GD
	LOAD CAPACITY KG	170	160	150	130	160	-	-	-	-	-	-	-

	ORD. NO. C RG DAC12 125		\varnothing 125 mm		C 160 mm		SWIVEL WHEEL WITH BRAKE						
	SUITABLE FOR CABINET	FLEXA 19	FLEXA 27	FLEXA 36	FLEXA CB	STANDARD B	STANDARD GE	STANDARD G	STANDARD GG	STANDARD GF	STANDARD GB	STANDARD GC	STANDARD GD
	LOAD CAPACITY KG	245	235	225	205	235	180	160	-	-	-	-	-

	ORD. NO. C RG DAC13 150		\varnothing 150 mm		C 185 mm		SWIVEL WHEEL WITH BRAKE						
	SUITABLE FOR CABINET	FLEXA 19	FLEXA 27	FLEXA 36	FLEXA CB	STANDARD B	STANDARD GE	STANDARD G	STANDARD GG	STANDARD GF	STANDARD GB	STANDARD GC	STANDARD GD
	LOAD CAPACITY KG	290	280	270	250	280	225	205	-	-	-	-	-

	ORD. NO. C RG DAC15 200		\varnothing 200 mm		C 242 mm		SWIVEL WHEEL WITH BRAKE						
	SUITABLE FOR CABINET	FLEXA 19	FLEXA 27	FLEXA 36	FLEXA CB	STANDARD B	STANDARD GE	STANDARD G	STANDARD GG	STANDARD GF	STANDARD GB	STANDARD GC	STANDARD GD
	LOAD CAPACITY KG	-	-	-	-	550	495	475	455	445	435	415	395

	ORD. NO. C RG BAC11 100		\varnothing 100 mm		C 130 mm		FIXED WHEEL						
	SUITABLE FOR CABINET	FLEXA 19	FLEXA 27	FLEXA 36	FLEXA CB	STANDARD B	STANDARD GE	STANDARD G	STANDARD GG	STANDARD GF	STANDARD GB	STANDARD GC	STANDARD GD
	LOAD CAPACITY KG	170	160	150	130	160	-	-	-	-	-	-	-

	ORD. NO. C RG BAC12 125		\varnothing 125 mm		C 160 mm		FIXED WHEEL						
	SUITABLE FOR CABINET	FLEXA 19	FLEXA 27	FLEXA 36	FLEXA CB	STANDARD B	STANDARD GE	STANDARD G	STANDARD GG	STANDARD GF	STANDARD GB	STANDARD GC	STANDARD GD
	LOAD CAPACITY KG	245	235	225	205	235	180	160	-	-	-	-	-

	ORD. NO. C RG BAC13 150		\varnothing 150 mm		C 185 mm		FIXED WHEEL						
	SUITABLE FOR CABINET	FLEXA 19	FLEXA 27	FLEXA 36	FLEXA CB	STANDARD B	STANDARD GE	STANDARD G	STANDARD GG	STANDARD GF	STANDARD GB	STANDARD GC	STANDARD GD
	LOAD CAPACITY KG	290	280	270	250	280	225	205	-	-	-	-	-

	ORD. NO. C RG BAC15 200		\varnothing 200 mm		C 242 mm		FIXED WHEEL						
	SUITABLE FOR CABINET	FLEXA 19	FLEXA 27	FLEXA 36	FLEXA CB	STANDARD B	STANDARD GE	STANDARD G	STANDARD GG	STANDARD GF	STANDARD GB	STANDARD GC	STANDARD GD
	LOAD CAPACITY KG	-	-	-	-	550	495	475	455	445	435	415	395

RUBBER WHEELS

RUBBER WHEELS

ELASTIC RUBBER WHEELS

ORD. NO. C RG DCE15 125 \varnothing 125 mm C 160 mm **SWIVEL WHEEL WITH BRAKE**

SUITABLE FOR CABINET	FLEXA 19	FLEXA 27	FLEXA 36	FLEXA CB	STANDARD B	STANDARD GE	STANDARD G	STANDARD GG	STANDARD GF	STANDARD GB	STANDARD GC	STANDARD GD
LOAD CAPACITY KG	400	400	270	445	475	420	400	380	370	360	340	320

ORD. NO. C RG DCE15 160 \varnothing 160 mm C 204 mm **SWIVEL WHEEL WITH BRAKE**

SUITABLE FOR CABINET	FLEXA 19	FLEXA 27	FLEXA 36	FLEXA CB	STANDARD B	STANDARD GE	STANDARD G	STANDARD GG	STANDARD GF	STANDARD GB	STANDARD GC	STANDARD GD
LOAD CAPACITY KG	-	-	-	-	600	600	600	600	600	600	600	600

ORD. NO. C RG BCE15 125 \varnothing 125 mm C 160 mm **FIXED WHEEL**

SUITABLE FOR CABINET	FLEXA 19	FLEXA 27	FLEXA 36	FLEXA CB	STANDARD B	STANDARD GE	STANDARD G	STANDARD GG	STANDARD GF	STANDARD GB	STANDARD GC	STANDARD GD
LOAD CAPACITY KG	400	400	270	445	475	420	400	380	370	360	340	320

ORD. NO. C RG BCE15 160 \varnothing 160 mm C 204 mm **FIXED WHEEL**

SUITABLE FOR CABINET	FLEXA 19	FLEXA 27	FLEXA 36	FLEXA CB	STANDARD B	STANDARD GE	STANDARD G	STANDARD GG	STANDARD GF	STANDARD GB	STANDARD GC	STANDARD GD
LOAD CAPACITY KG	-	-	-	-	600	600	600	600	600	600	600	600

NO-SMEAR RUBBER WHEELS

ORD. NO. C RG DPH22 125 \varnothing 125 mm C 160 mm **SWIVEL WHEEL WITH BRAKE**

SUITABLE FOR CABINET	FLEXA 19	FLEXA 27	FLEXA 36	FLEXA CB	STANDARD B	STANDARD GE	STANDARD G	STANDARD GG	STANDARD GF	STANDARD GB	STANDARD GC	STANDARD GD
LOAD CAPACITY KG	245	235	225	205	235	180	160	-	-	-	-	-

ORD. NO. C RG DPH25 160 \varnothing 160 mm C 204 mm **SWIVEL WHEEL WITH BRAKE**

SUITABLE FOR CABINET	FLEXA 19	FLEXA 27	FLEXA 36	FLEXA CB	STANDARD B	STANDARD GE	STANDARD G	STANDARD GG	STANDARD GF	STANDARD GB	STANDARD GC	STANDARD GD
LOAD CAPACITY KG	-	-	-	-	535	480	460	440	430	420	400	380

ORD. NO. C RG BPH22 125 \varnothing 125 mm C 160 mm **FIXED WHEEL**

SUITABLE FOR CABINET	FLEXA 19	FLEXA 27	FLEXA 36	FLEXA CB	STANDARD B	STANDARD GE	STANDARD G	STANDARD GG	STANDARD GF	STANDARD GB	STANDARD GC	STANDARD GD
LOAD CAPACITY KG	245	235	225	205	235	180	160	-	-	-	-	-

ORD. NO. C RG BPH25 160 \varnothing 160 mm C 204 mm **FIXED WHEEL**

SUITABLE FOR CABINET	FLEXA 19	FLEXA 27	FLEXA 36	FLEXA CB	STANDARD B	STANDARD GE	STANDARD G	STANDARD GG	STANDARD GF	STANDARD GB	STANDARD GC	STANDARD GD
LOAD CAPACITY KG	-	-	-	-	535	480	460	440	430	420	400	380

CONDUCTIVE WHEELS

CONDUCTIVE WHEELS

	ORD. NO. C RG DDD11 100	\varnothing 100 mm		C 130 mm		SWIVEL WHEEL WITH BRAKE							
	SUITABLE FOR CABINET	FLEXA 19	FLEXA 27	FLEXA 36	FLEXA CB	STANDARD B	STANDARD GE	STANDARD G	STANDARD GG	STANDARD GF	STANDARD GB	STANDARD GC	STANDARD GD
LOAD CAPACITY KG	170	160	150	130	160	-	-	-	-	-	-	-	-
	ORD. NO. C RG CDD11 100	\varnothing 100 mm		C 130 mm		SWIVEL WHEEL WITHOUT BRAKE							
	SUITABLE FOR CABINET	FLEXA 19	FLEXA 27	FLEXA 36	FLEXA CB	STANDARD B	STANDARD GE	STANDARD G	STANDARD GG	STANDARD GF	STANDARD GB	STANDARD GC	STANDARD GD
LOAD CAPACITY KG	170	160	150	130	160	-	-	-	-	-	-	-	-
	ORD. NO. C RG CDD13 150	\varnothing 150 mm		C 185 mm		SWIVEL WHEEL WITHOUT BRAKE							
	SUITABLE FOR CABINET	FLEXA 19	FLEXA 27	FLEXA 36	FLEXA CB	STANDARD B	STANDARD GE	STANDARD G	STANDARD GG	STANDARD GF	STANDARD GB	STANDARD GC	STANDARD GD
LOAD CAPACITY KG	290	280	270	250	280	225	205	-	-	-	-	-	-
	ORD. NO. C RG BDD11 100	\varnothing 100 mm		C 130 mm		FIXED WHEEL							
	SUITABLE FOR CABINET	FLEXA 19	FLEXA 27	FLEXA 36	FLEXA CB	STANDARD B	STANDARD GE	STANDARD G	STANDARD GG	STANDARD GF	STANDARD GB	STANDARD GC	STANDARD GD
LOAD CAPACITY KG	170	160	150	130	160	-	-	-	-	-	-	-	-
	ORD. NO. C RG BDD13 150	\varnothing 150 mm		C 185 mm		FIXED WHEEL							
	SUITABLE FOR CABINET	FLEXA 19	FLEXA 27	FLEXA 36	FLEXA CB	STANDARD B	STANDARD GE	STANDARD G	STANDARD GG	STANDARD GF	STANDARD GB	STANDARD GC	STANDARD GD
LOAD CAPACITY KG	290	280	270	250	280	225	205	-	-	-	-	-	-



■ RAL 7000

INFO ■

www.famispa.com